

19

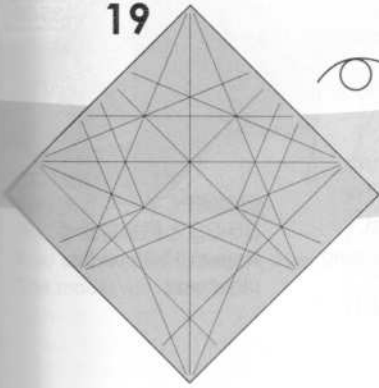

20

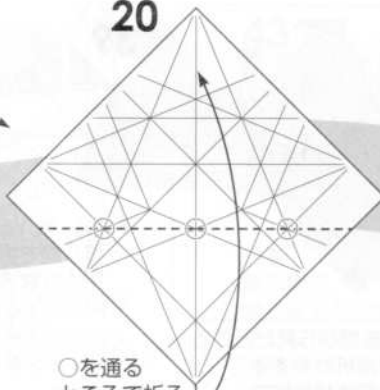

○を通る
ところで折る
Fold at the circled points.

21

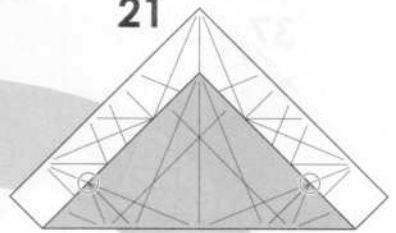

○のところで折り筋が一致している
Crease lines should match at the circled points.

22

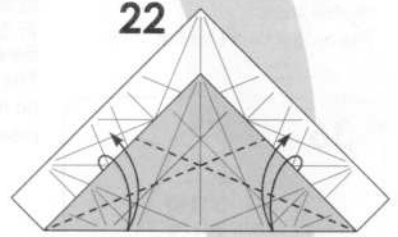

フチを折り筋に合わせて
折り筋をつける
Fold the edges to the crease
line and unfold.

25

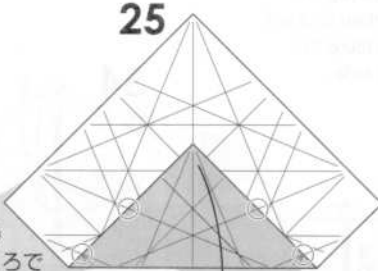

○の
ところで
折り筋が一致している
折ったら戻す
Crease lines should match
at the circled points.
Unfold.

23

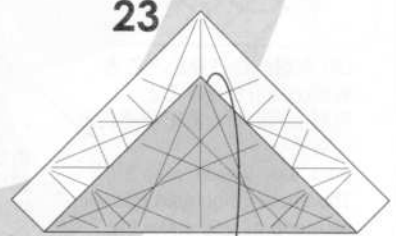

開く
Unfold.

26

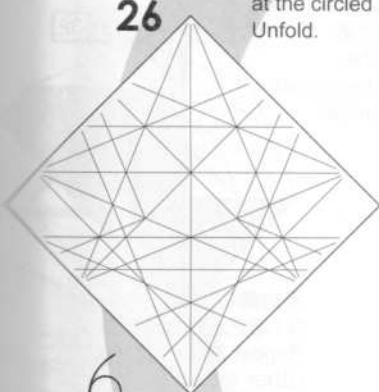

24

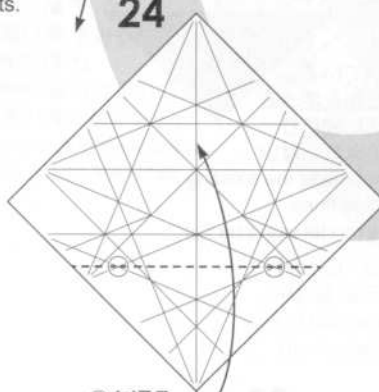

○を通る
ところで折り筋をつける
Fold at the circled points.

27

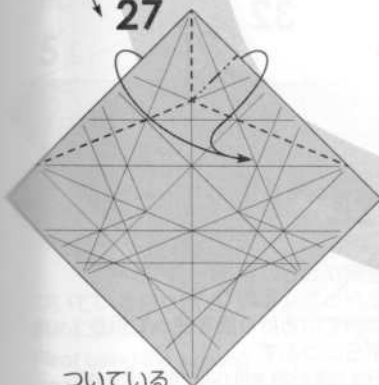

ついている
折り筋でつまみ折り
Rabbit ear fold.

28

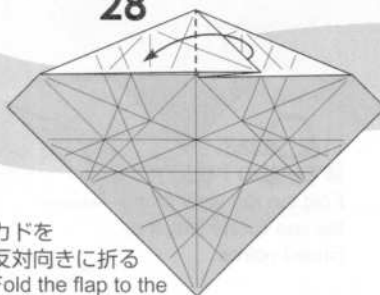

カドを
反対向きに折る
Fold the flap to the
left.

29

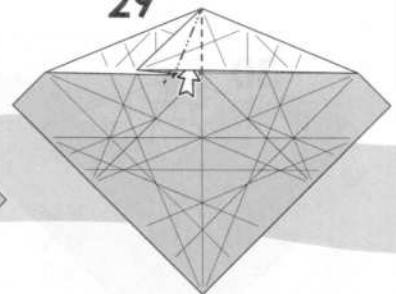

内側を広げてつぶす
Open and squash.

37

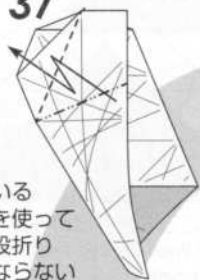

ついている
折り筋を使って
斜めに段折り
平にはならない
Pleat using the existing
crease lines.
The model won't be flat.

38

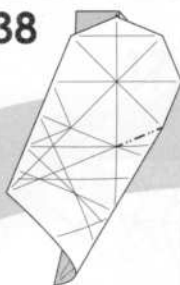

37を裏側から見たところ
表側の段折りをすると
自然と図の折り筋で
折ることになる
Back side view of step 37.
The shown mountain fold will
be made as you make the
pleat on the front side.

39

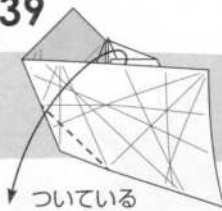

ついている
折り筋で折る
平にはならない
Fold at the existing
crease line.
The model won't
be flat.

40

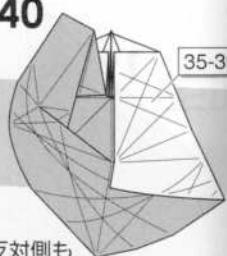

反対側も
35-39と同様に折る
Repeat 35-39 on the
other side.

36

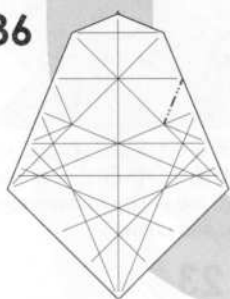

35を裏側から見たところ
表側の段折りをすると
自然と図の折り筋で折ること
になる
Back side view of step 35.
The shown mountain fold will
be made as you make the
pleat on the front side.

35

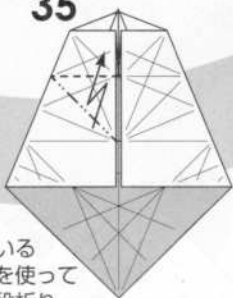

ついている
折り筋を使って
斜めに段折り
平にはならない
Pleat using the existing
crease lines.
The model won't be flat.

34

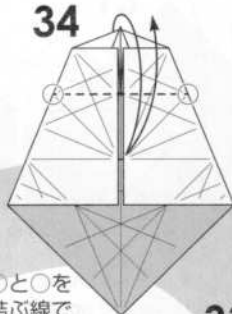

○と○を
結ぶ線で
折り筋をつける
Fold along the
connecting the circled
points and unfold.

33



反対側も
31-32と同様に折る
Repeat 31-32 on the
other side.

30

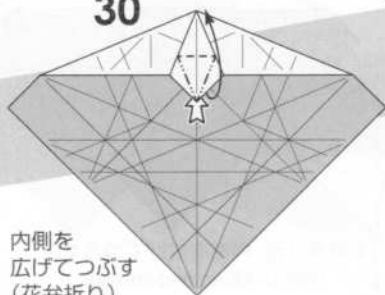

内側を
広げてつぶす
(花弁折り)
Petal fold.

31

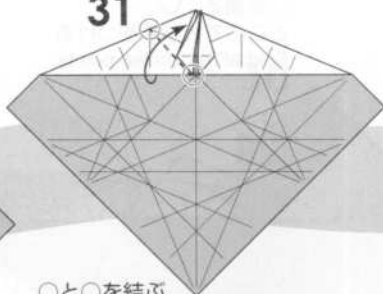

○と○を結ぶ
線で手前の1枚だけ折る
Fold the top layer along
the line connecting the
circled points.

32



左側が起き
上がってくるので
ついている折り筋を使って折り
平らにつぶす
The left side will naturally rise up
as you fold, so use the existing
crease lines to fold and squash it flat.

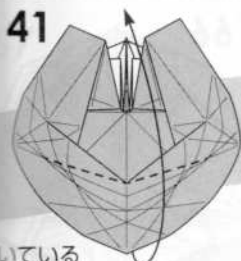

41
ついている
折り筋で閉じるように折る
平にはならない
Fold at the existing crease lines.
The model won't be flat.

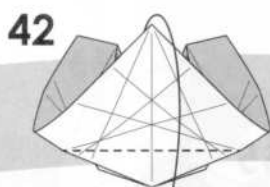

42
ついている
折り筋で折る
平にはならない
Fold at the existing
crease line.
The model won't be flat.

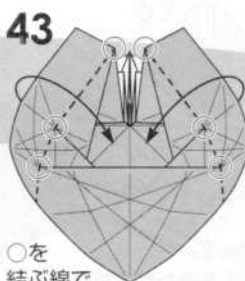

43
○を
結ぶ線で
閉じるように折る
平になる
Fold along the line
connecting the circled
points.
The model will be flat.

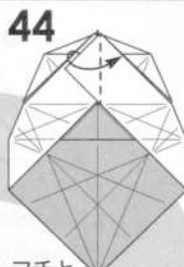

44
フチと
フチを合わせて折る
Fold the edge to the
edge.

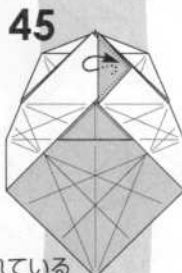

45
隠れている
カドを手前に出す
Bring the hidden
corner to the front.

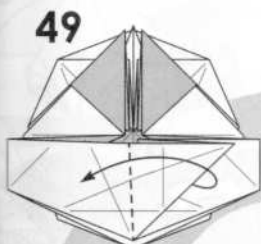

49
カドを反対側へ折る
Fold the flap to the
other side.

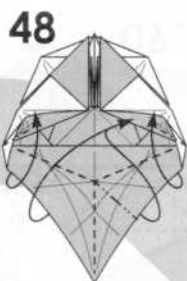

48
ついている折り筋で
つまみ折り
左右の部分は平らにつぶす
Rabbit ear fold using
the existing crease lines
and quash the sides.

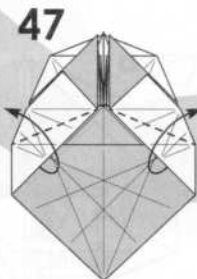

47
ついている折り筋で折る
平にはならない
Fold at the existing crease lines.
The model won't be flat.

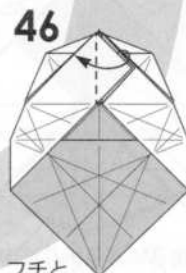

46
フチと
フチを合わせて折る
Fold the edge to the
edge.

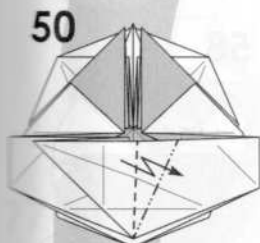

50
ついている折り筋で
斜めに段折り
Pleat using the existing
crease lines.

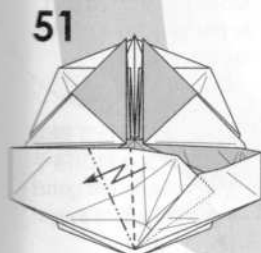

51
ついている折り筋で
斜めに段折り
Pleat using the existing
crease lines.

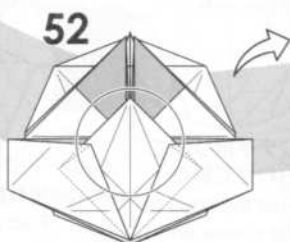

52

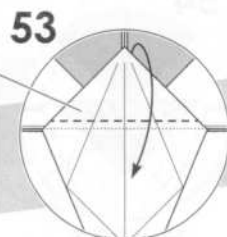
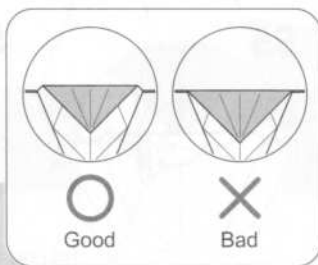

53
後ろにあるフチより
少し上で折る
Fold slightly above
the edge at the back.

64

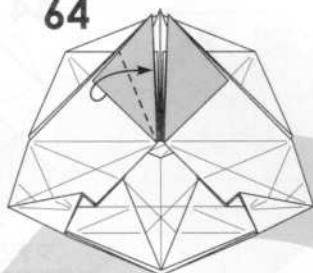

フチとフチを合わせて折る
Fold the edge to the edge.

63

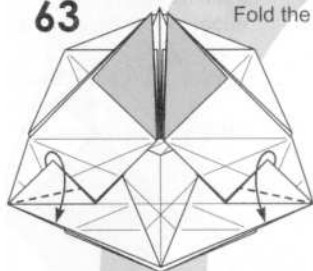

フチとフチを合わせて折る
Fold the edge to the edge.

62

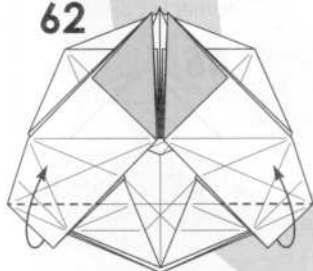

後ろにある折り筋の
ところでカドを折る
Fold the flaps at the
crease lines under
the flaps.

61

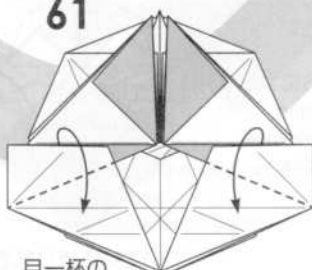

目一杯の
ところでカドを下へ折る
重なっている紙が
ずれないように注意
Fold the flaps down at the joint.
Ensure that the paper layers do
not shift.

65

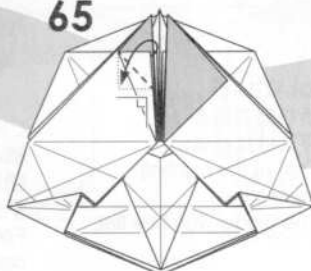

カドを 45°で折る
Fold the flap at 45
degrees.

66

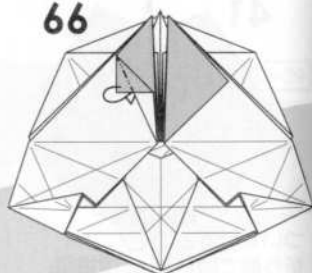

カドを後ろにある
フチのところで折り
一番奥の隙間に入れる
Mountain fold at the edge
at the back and insert the
corner in the rearmost slot.

60

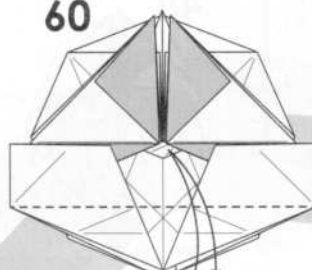

目一杯のところで
折って折り筋をつける
Fold the flap at the joint
and unfold.

59



58

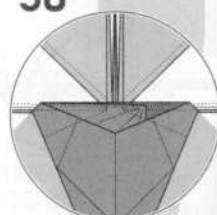

■で示した部分が紙の
重なりが一番後ろにくる
ように移動させる
Move the shaded part
to the very back of the
layers.

54

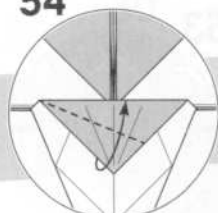

フチとフチを
合わせて折る
Fold the edge
to the edge.

55

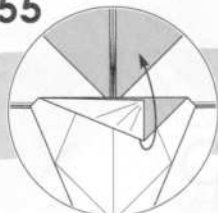

53で折った
ところを開く
unfold the fold
made at step 53.

56

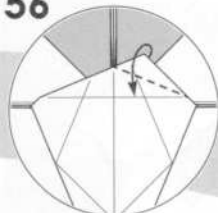

フチを折り筋に
合わせて折る
Fold the edge to
the crease line.

57

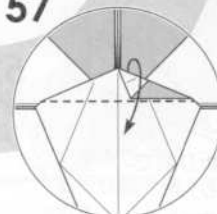

折り筋のところで折る
Fold at the crease line.

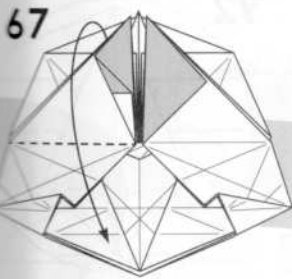

67
カドを目一杯のところ
で折る
Fold the flap down at the joint.

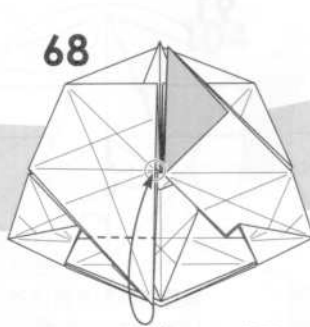

68
カドを○に合わせて折る
Fold the corner to the
circled point.

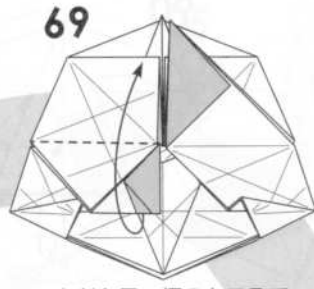

69
カドを目一杯のところ
で上へ折る
Fold the flap up at the joint.

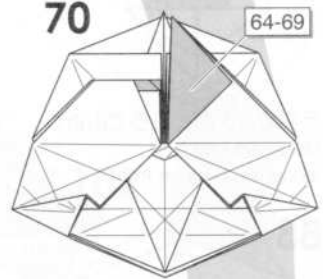

70
反対側も 64-69 と同様に折る
Repeat 64-69 on the other side.



75
反対側も 72-74 と
同様に折る
Repeat 72-74 on the
other side.

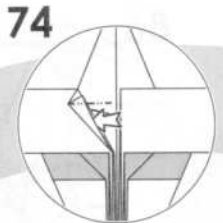

74
内側を広げてつぶす
Open and squash.



73
フチとフチを
合わせて折る
Fold the edge
to the edge.

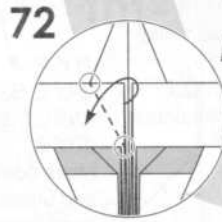

72
○と○を結ぶ線
でカドを折る
Fold along the line
connecting the circled
points.

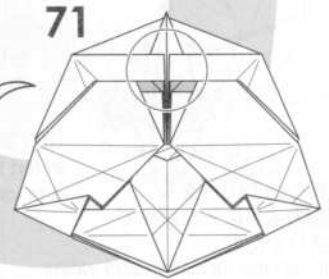

71



76



77
■で示した部分を
手前に持ってくる
Bring the shaded
layers to the front.

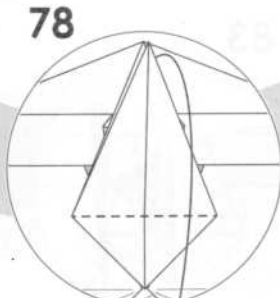

78
カドを下へ折る
Fold the flap down.

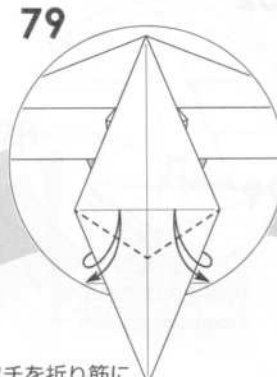

79
フチを折り筋に
合わせて折り筋をつける
折るのは中心線まで
Fold the edges to the crease line.
Fold only to the centre line.

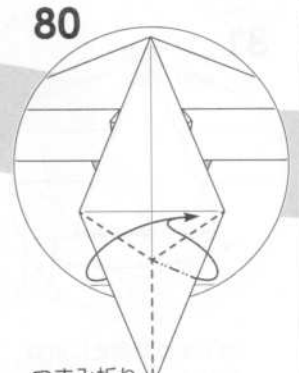

80
つまみ折り
Rabbit ear fold.



89
手前のフチのところで山折り
Mountain fold
along the edge in front.

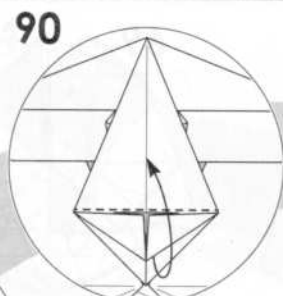

90
カドをめくるように
上へ折る
Flip the flap at the joint.

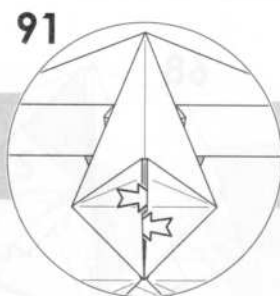

91
両側の隙間を広げる
Open the pockets.



92
ついている折り筋で
山折りしながら
めくっていたカドを
下ろしてつぶす
Mountain fold at the
crease lines, fold down
the flipped flap and
squash.



88
ついている
折り筋の山谷を
図のように入れ替えて
折りたたむ
Invert the mountain and valley
fold as shown and collapse.

谷折りのまま
Keep as valley.

山谷を入れ替え
Invert the mountain
and valley.

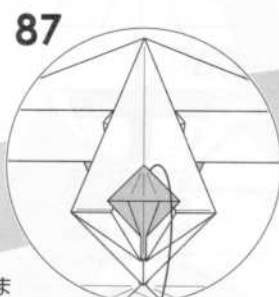

87
カドを
下げて 82 で
つぶした部分を
広げる
Move down the flap
and unfold the squash
done in step 82.

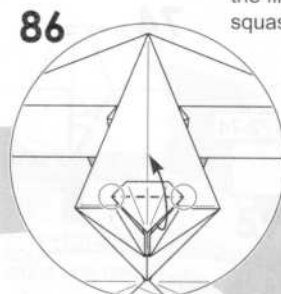

86
○を結ぶ線でカドを折る
Fold at the circled points.



85
カドを
目一杯のところ
で折る
Fold the flaps outwards
at the joint.



81
カドを反対向きに折る
Fold the flap to the
opposite side.



82
内側を広げてつぶす
Open and squash.



83
図のようにカドを
折って折り筋をつける
Fold as shown and unfold.



84
カドを沈めるように
折る
Open sink.

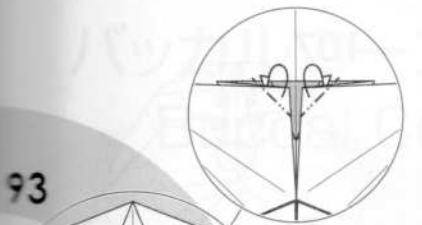

93

カドを少し
後ろに折る
Mountain fold
the corners.



94

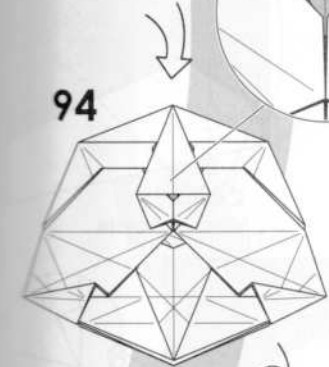
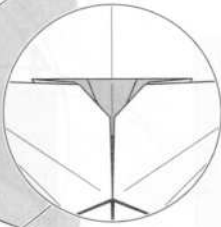

95

半分に折る
Fold in half

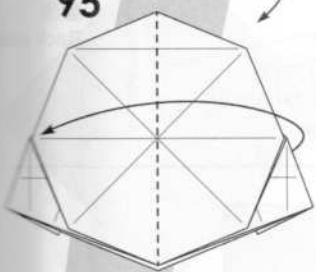

96

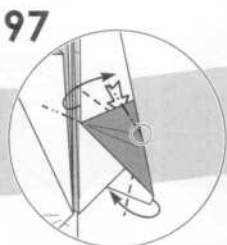

○を支点にして■部分を
回転させるようにずらす
Swivel the shaded triangle.
Use the circled point as a pivot.



97

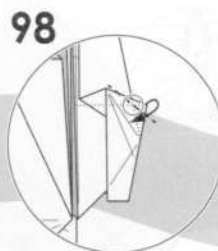

98

カドを折る
Fold the corner.

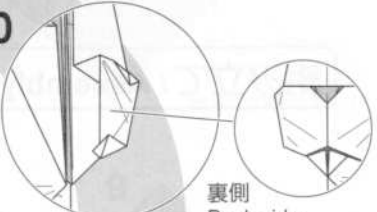

99

カドを折る
Fold the corner.

裏側
Back side

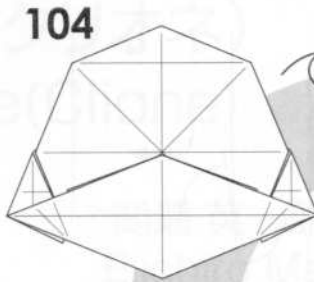

104

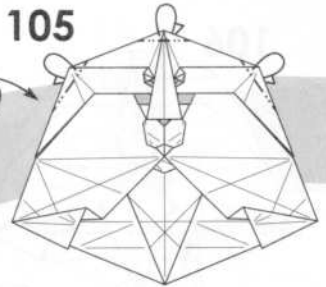

105

カドを後ろに折って
輪郭を丸くする
Fold the corners behind.

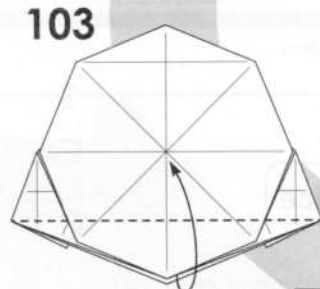

103

目一杯のところで
カドを折る
Fold the flap at the
joint.

95-100

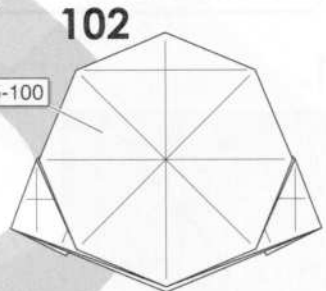

102

反対側も 95-100 と
同様に折る
Repeat 95-100
on the other side.

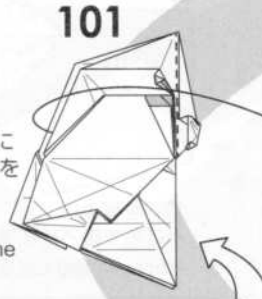

101

93で半分に
折った部分を
戻す
Unfold
the fold done
in step 93.

100

106

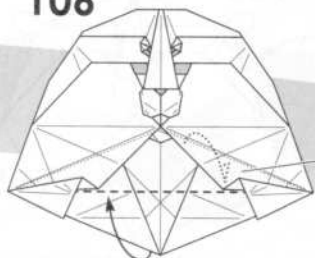

菱形の部分を起こし
スタンドにして自立させる
Fold the base and make it stand.

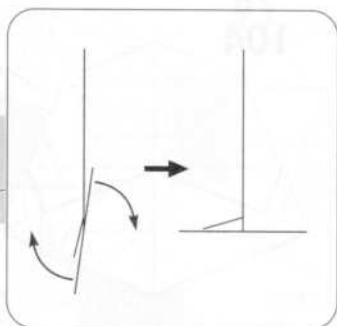

107

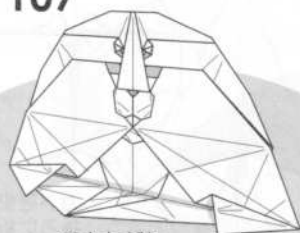

できあがり
Model complete.

海と流氷 / Sea and Ice

1

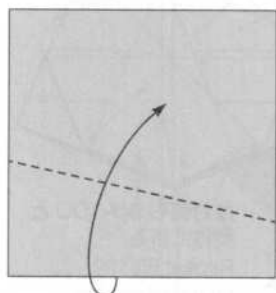

フチを程よいところで斜めに折る
Fold the edge with slight angle.

この幅がアザラシより
狭くならないように
Make sure this width
is wider than the seal.



2

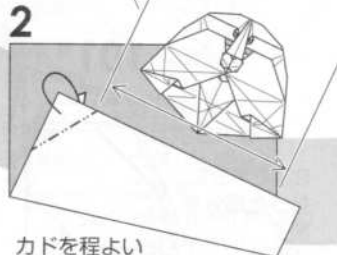

カドを程よい
ところで後ろに折る
Mountain fold the corner.
Back side

3



カドをフチの
ところで後ろに折る
Mountain fold the corner
along the edge.

4



できあがり
Model complete.

組み立て / Assembly

1

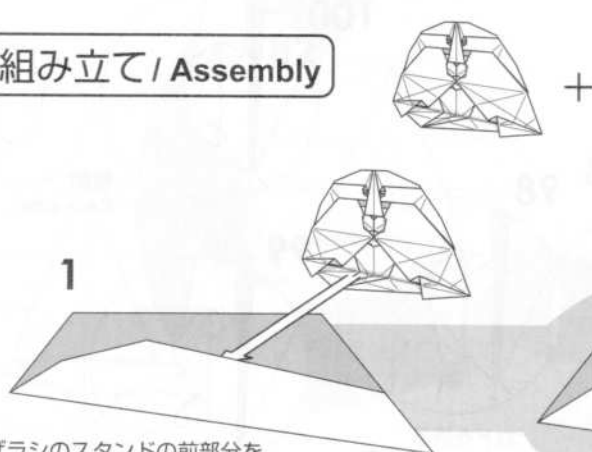

アザラシのスタンドの前部分を
海と氷の隙間に差し込む
Insert the front side of the base of the seal
into the gap between the ice and the sea.

2

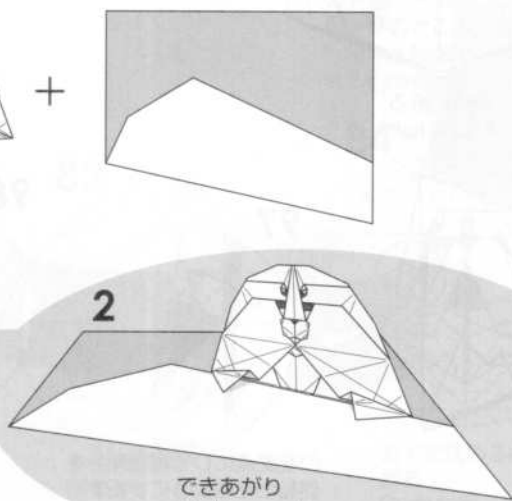

できあがり
Model complete.

バッカルコーン(クリオネ) Buccal Cone(Clione)

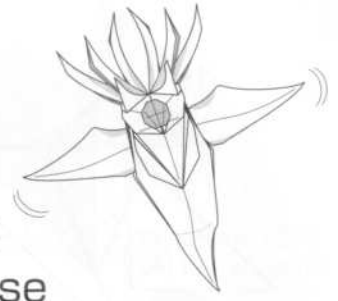

Created: May, 2024
Diagrammed: June, 2024

間瀬 英一郎
Eiichiro Mase

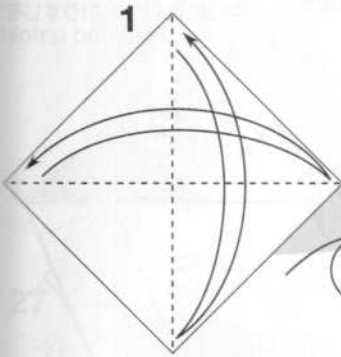

1
折りすじをつける
Fold and unfold.

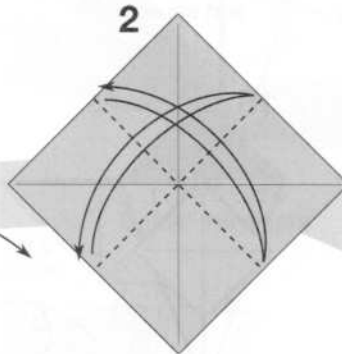

2
折りすじをつける
Fold and unfold.

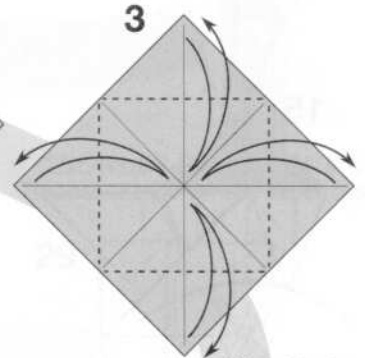

3
中心に合わせて
折りすじをつける
Fold and unfold.

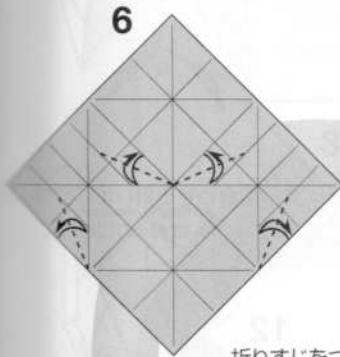

4
折りすじをつける
Fold and unfold.

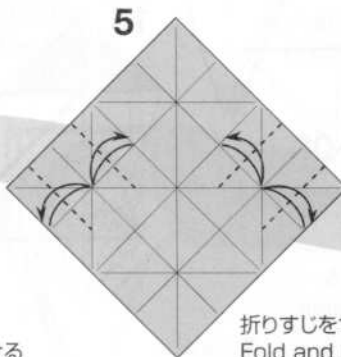

5
折りすじをつける
Fold and unfold.

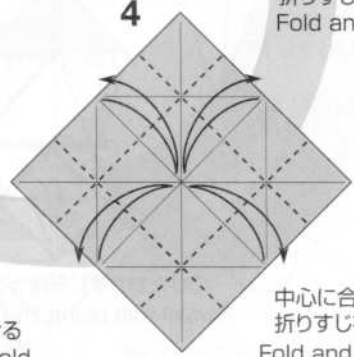

6
中心に合わせて
折りすじをつける
Fold and unfold.

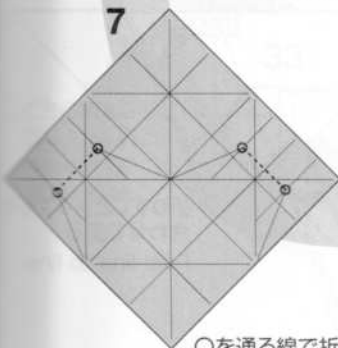

7
○を通る線で折りすじをつける
Fold and unfold at
the circled points.

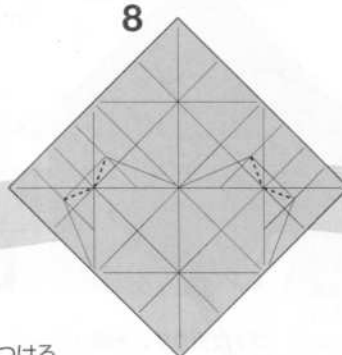

8
折りすじをつける
Fold and unfold.

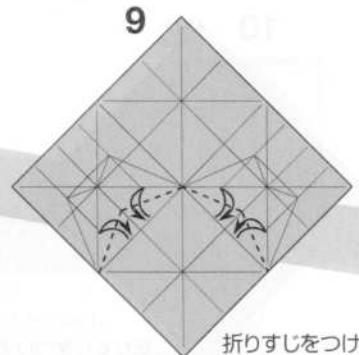

9
折りすじをつける
Fold and unfold.

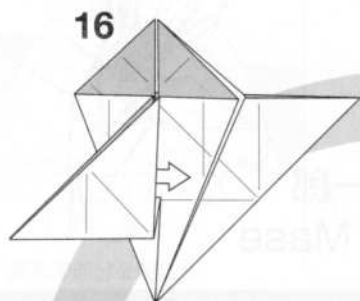

16
山と谷を入れ替えて
内側の紙を出す
Reverse the inner layer.

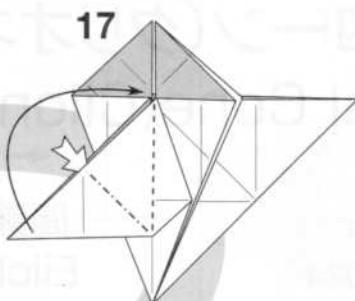

17
中心のカドのすき間を広げて
つぶすように折る
Open the slit of the center layers
and squash.

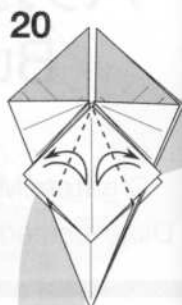

20
中心に合わせて折りすじをつける
Fold and unfold.

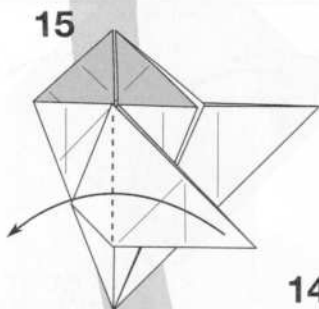

15
カドを左へ折る
Fold to the left.

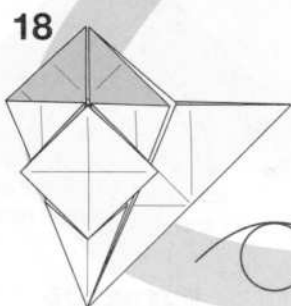

18
つけた折りすじを使って折る
Swivel fold using the crease.

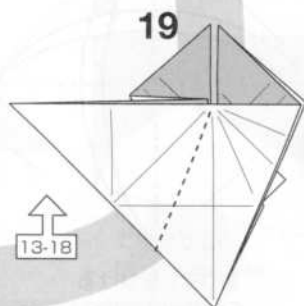

19
こちら側も13-18と同じように折る
Repeat 13-18 on the other side

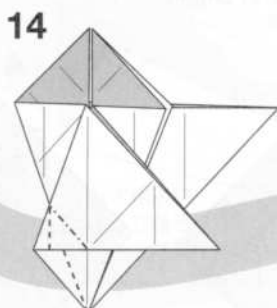

14
つけた折りすじを使って折る
Swivel fold using the crease.

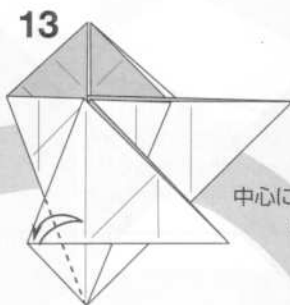

13
中心に合わせて折りすじをつける
Fold and unfold.

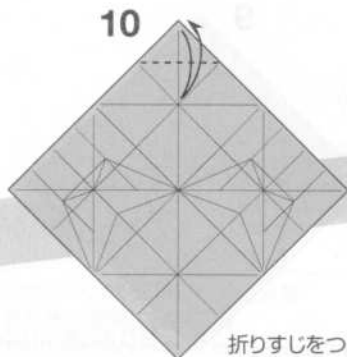

10
折りすじをつける
Fold and unfold.

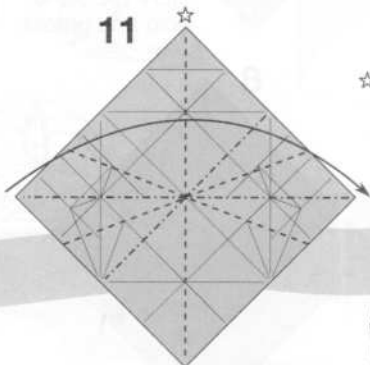

11
つけた折りすじを使って
折りたたむ
Assemble using the creases.

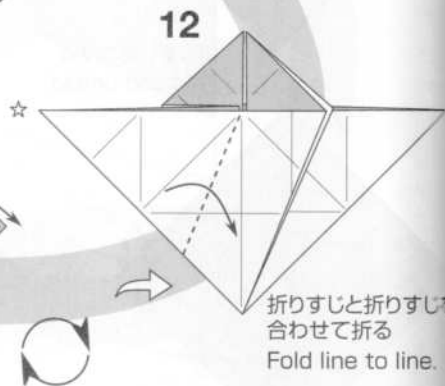

12
折りすじと折りすじを
合わせて折る
Fold line to line.

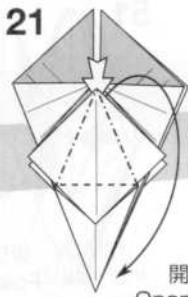

21 開いてつぶす
Open and squash.

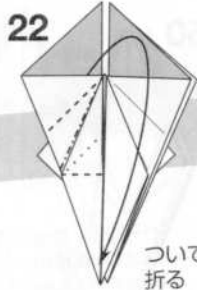

22 ついている折りすじを使って折る
Assemble using the creases.

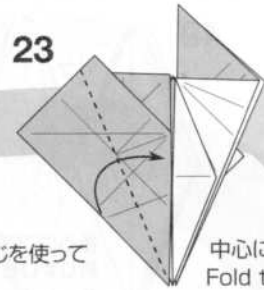

23 中心に合わせて折る
Fold to the center.

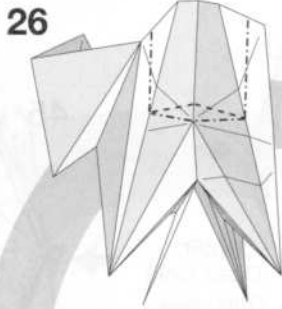

26 ついている折りすじを使って折る
Assemble using the creases.

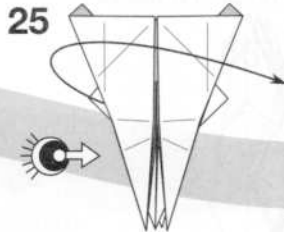

25 ヒダをひろげる
Unfold the pleats.

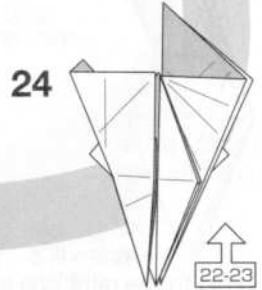

24 こちら側も22-23と同じように折る
Repeat 22-23 on the other side.

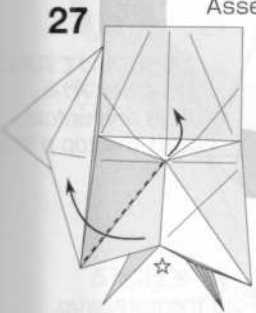

27 平坦に折りたたむ
Flatten the model.

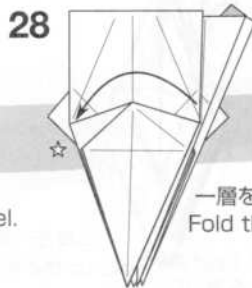

28 一層を左へ折る
Fold the corner left.

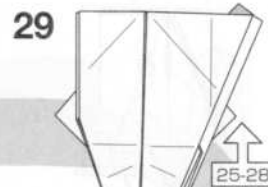

29 こちら側も25-28と同じように折る
Repeat 25-28 on the other side.

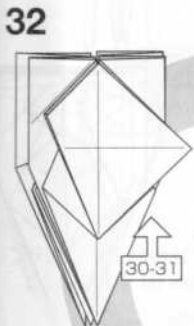

32 こちら側も30-31と同じように折る
Repeat 30-31 on the other side.

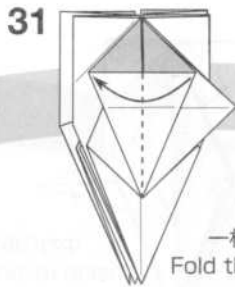

31 一枚左へ折る
Fold the corner left.

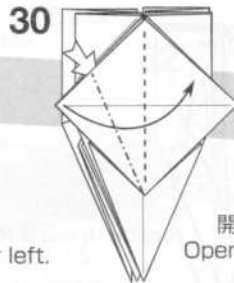

30 開いてつぶす
Open and squash.



33 中心に合わせて折りすじをつける
Fold and unfold.

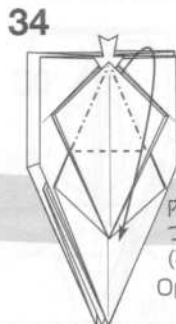

34 内側を広げてつぶすように折る
(花弁折り)
Open and squash.

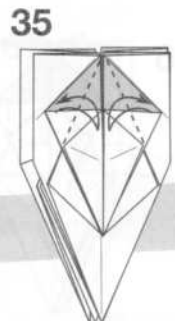

35 中心に合わせて折りすじをつける
Fold and unfold.

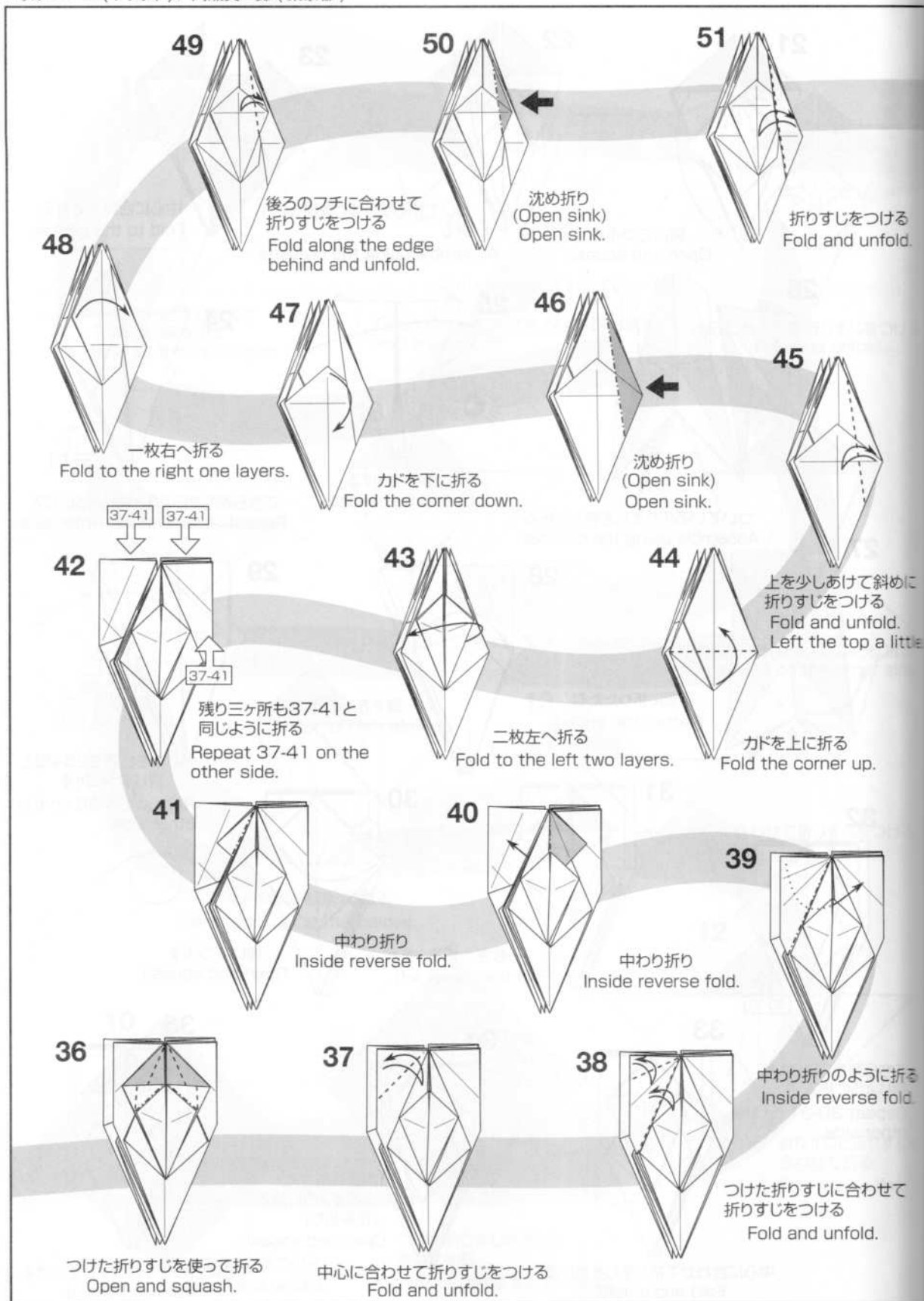

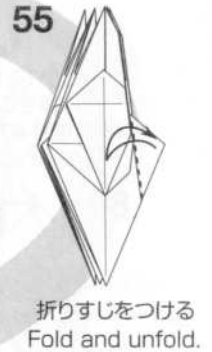
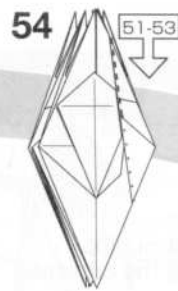
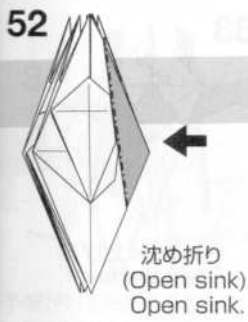

後ろ側も51-53と同じように折る
Repeat 51-53 on the other side.

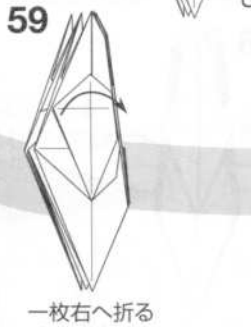
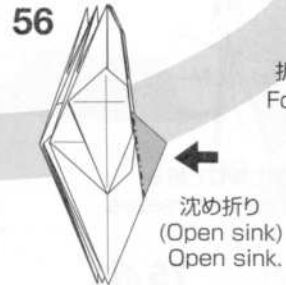
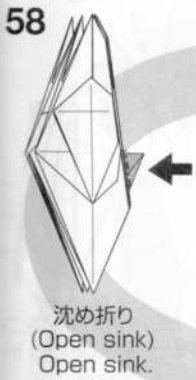

こちら側も43-59と
同じように折る
Repeat 43-59 on the
other side.

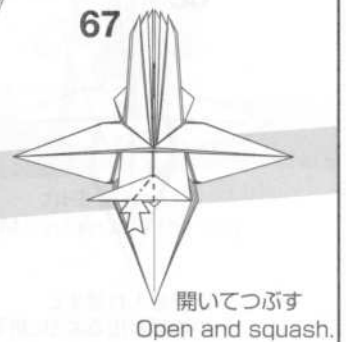
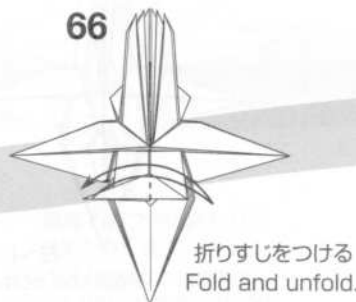
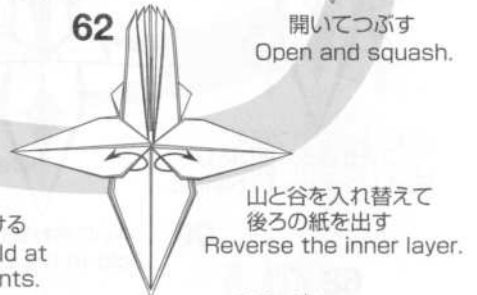
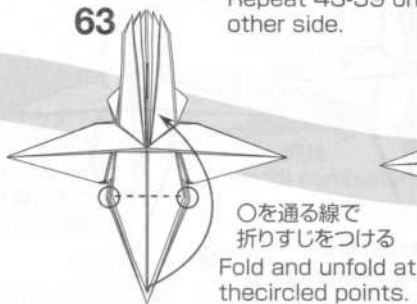
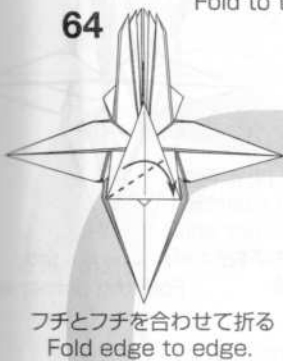
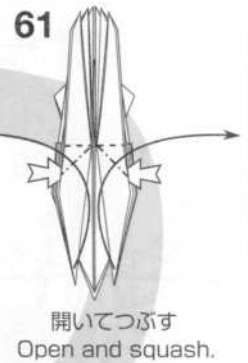

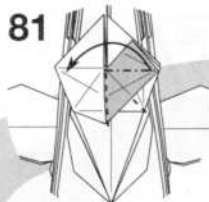

81 ついている折りすじで
内側を広げてつぶすように折る
Open and squash using the creases.

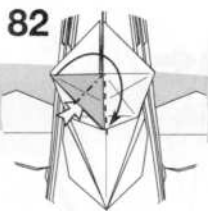

82 開いてつぶす
Open and squash.

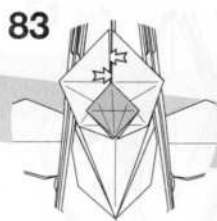

83 内側を軽く広げる
Open the layer.

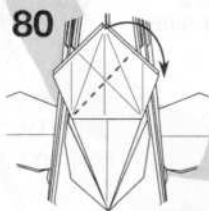

80 ついている折りすじで折る
Assemble using the creases.

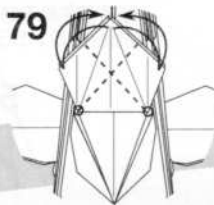

79 ○のところから
折りすじをつける
Fold at the circled
points and unfold.

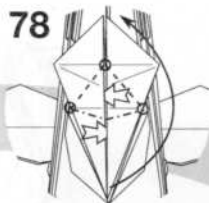

78 内側を広げて
つぶすように折る
Open the flap
and squash.

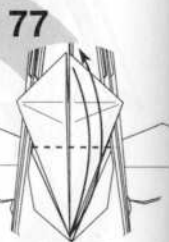

77 半分の折りすじをつける
Fold and unfold in half.

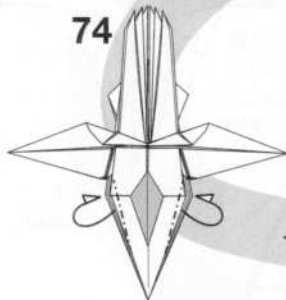
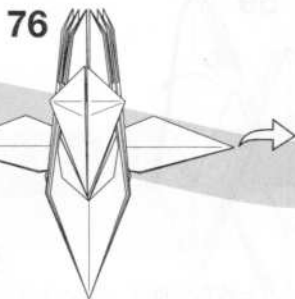
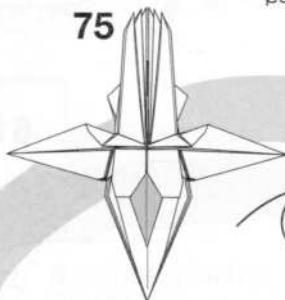

74 フチを後ろへ折り込む
Fold the edge to behind.

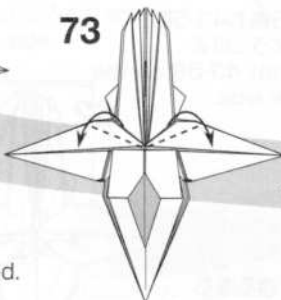

73 中心に合わせて折る
Fold to the center.

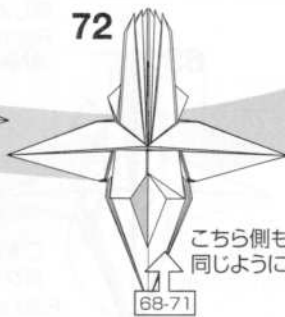

72 こちら側も68-71と
同じように折る

Repeat 68-71 on the
other side.

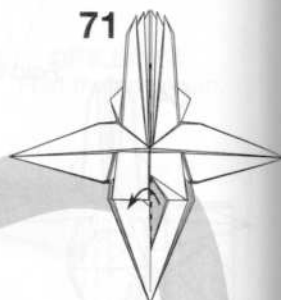

71 一枚左へ折る
Fold the corner left.

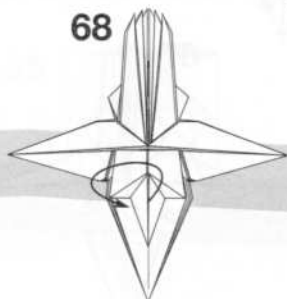

68 山谷を入れ替えて
中の紙が出るように折る
Reverse the corner.

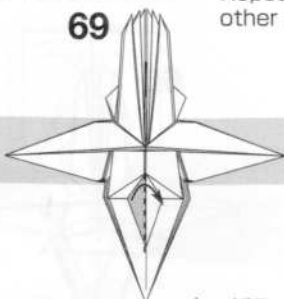

69 右へ折る
Fold the corner right.

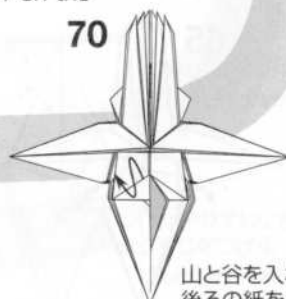

70 山と谷を入れ替えて
後ろの紙を出す
Reverse the inner layer.

84

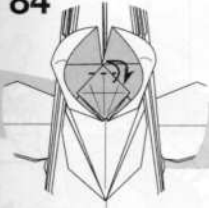

異なる予感かしても折りすじをつける
Fold and unfold.

85

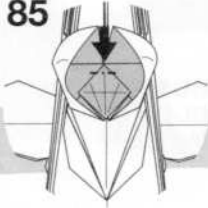

沈め折り
(Open sink)
Open sink.

86

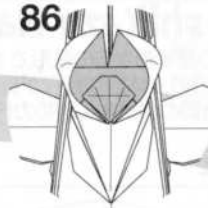

広げたところを元にもどす
Close them.

87

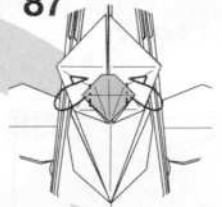

カドを後ろへ折る
Mountain fold the flap.

94

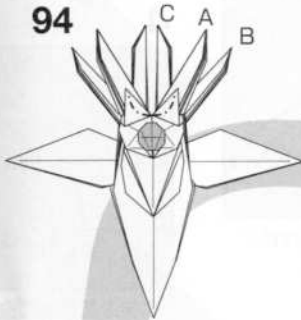

ツノを細くするように折る
Fold to make the horn thinner.

95

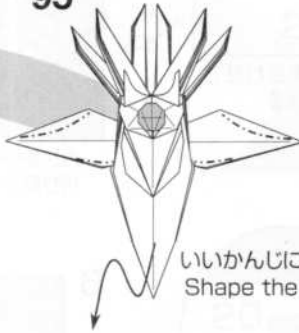

いいかんじに仕上げる
Shape the model.

88

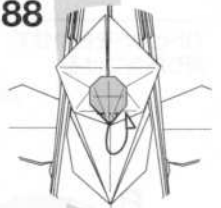

カドを後ろへ折る
Mountain fold the flap.

93

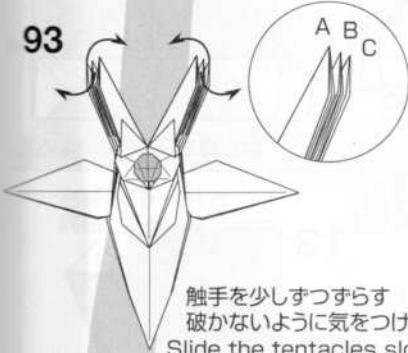

触手を少しずつずらす
破かないように気をつける
Slide the tentacles slowly.
Be careful not to tear them.

完成

Model completed.

89

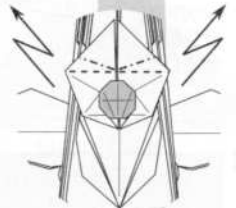

手前にななめに段折り
Pleat fold to front.

92

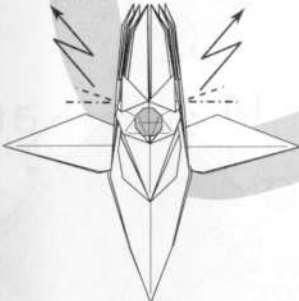

まとめて後ろにななめに段折り
Pleat fold to back.

91

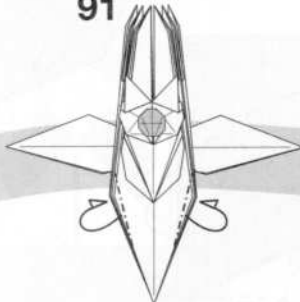

一番後ろのフチに合わせて
3枚まとめて後ろに折る
Fold 3 layers together
along the edges behind.

90

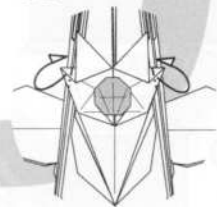

カドを後ろへ折る
Mountain fold the flap.

カエル 創作・折り図 / 生井敏一

Frog by Toshikazu Namai

推奨サイズ 15cm×15cm。風船の基本形からの造形です。ぐらい折りを極力排して再現性を高めました。61～68の立体的な行程が折り難いかもしれません。仕上げ段階の112～113では、後ろ脚の付け根に肘のカドが引っ掛かって上手く安定してくれます。

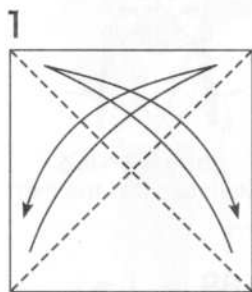
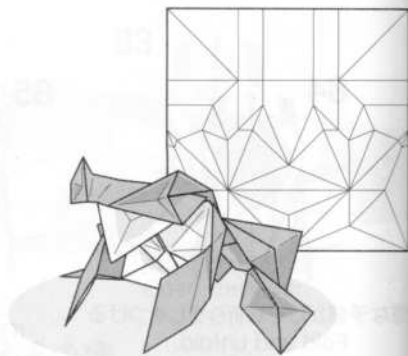

1 カドとカドを合わせて折り筋をつける

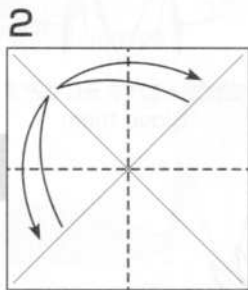

2 フチとフチを合わせて折り筋をつける

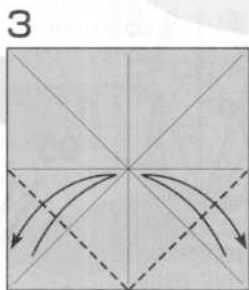

3 カドを中心に合わせて折り筋をつける

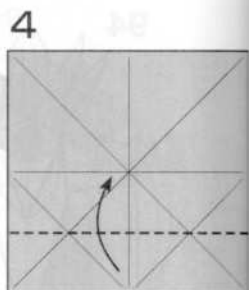

4 フチを折り筋に合わせて折る

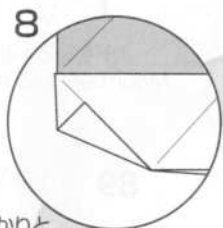

5 しっかりと折り筋をついたら全てひろげる

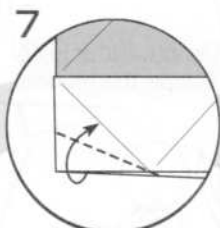

6 フチを折り筋に合わせて折る

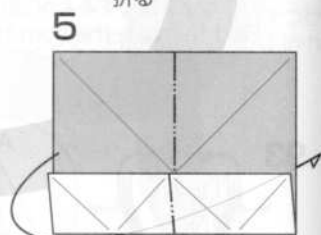

8 中心線で向こう側に折る

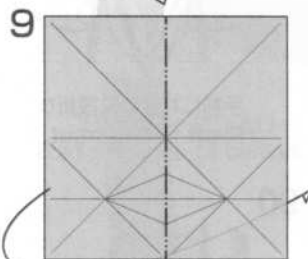

9 中心線で向こう側に折る

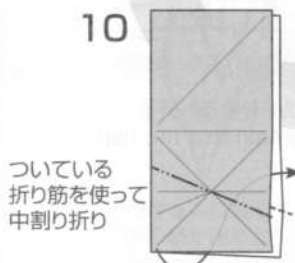
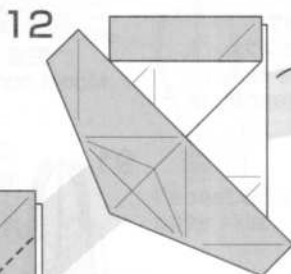

10 ついている折り筋を使って中割り折り

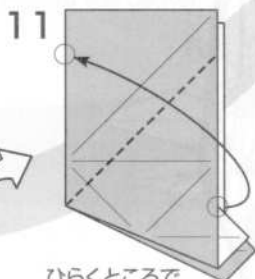

11 ひらくところでOとOを合わせて折る

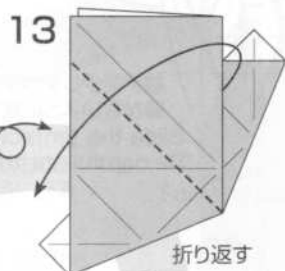

12 折り返す

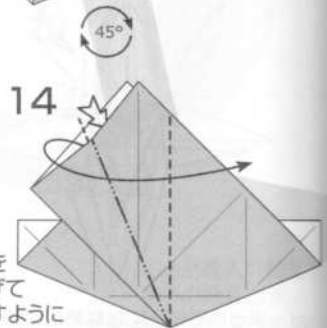

13 内側をひろげてつぶすように折る

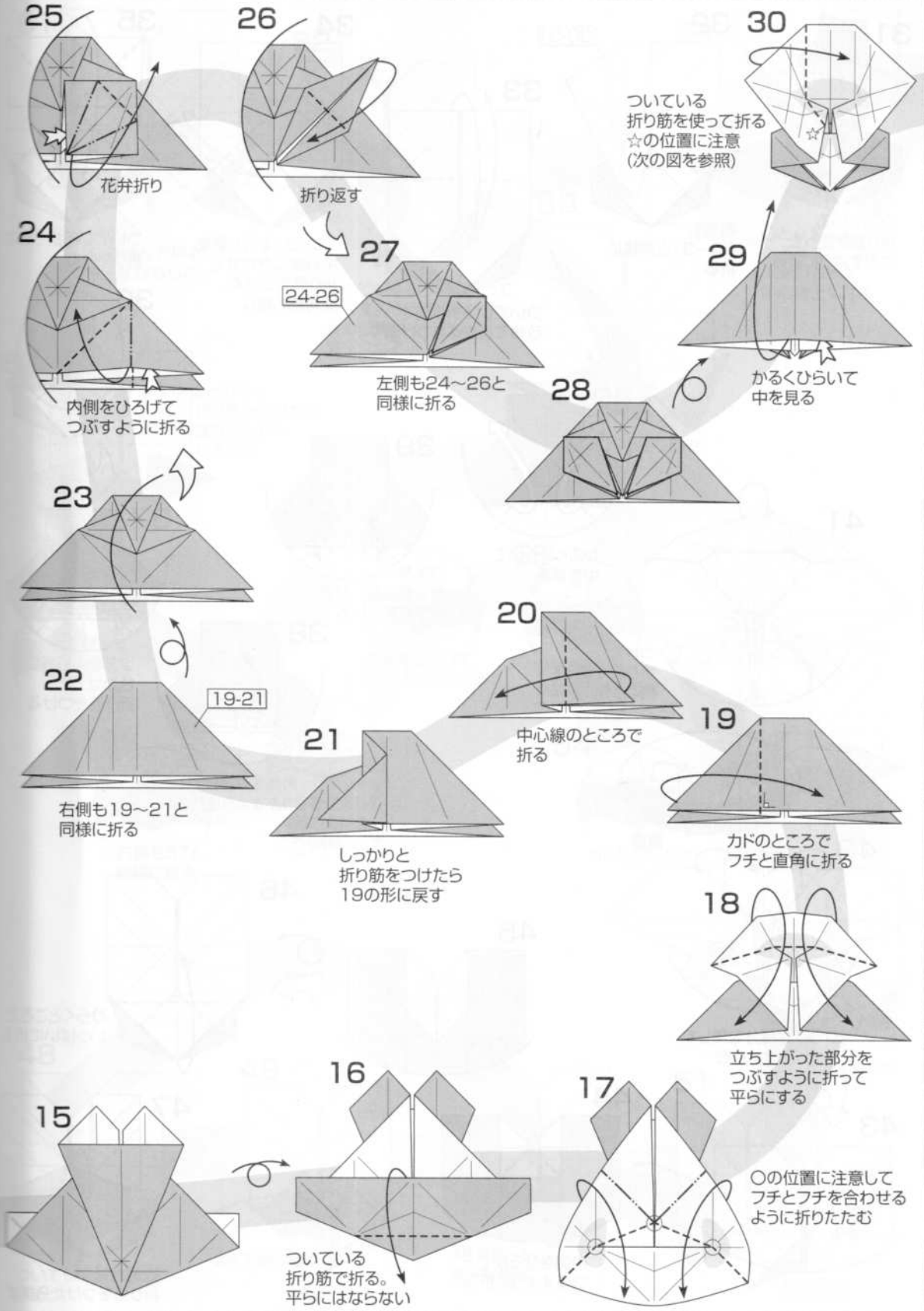

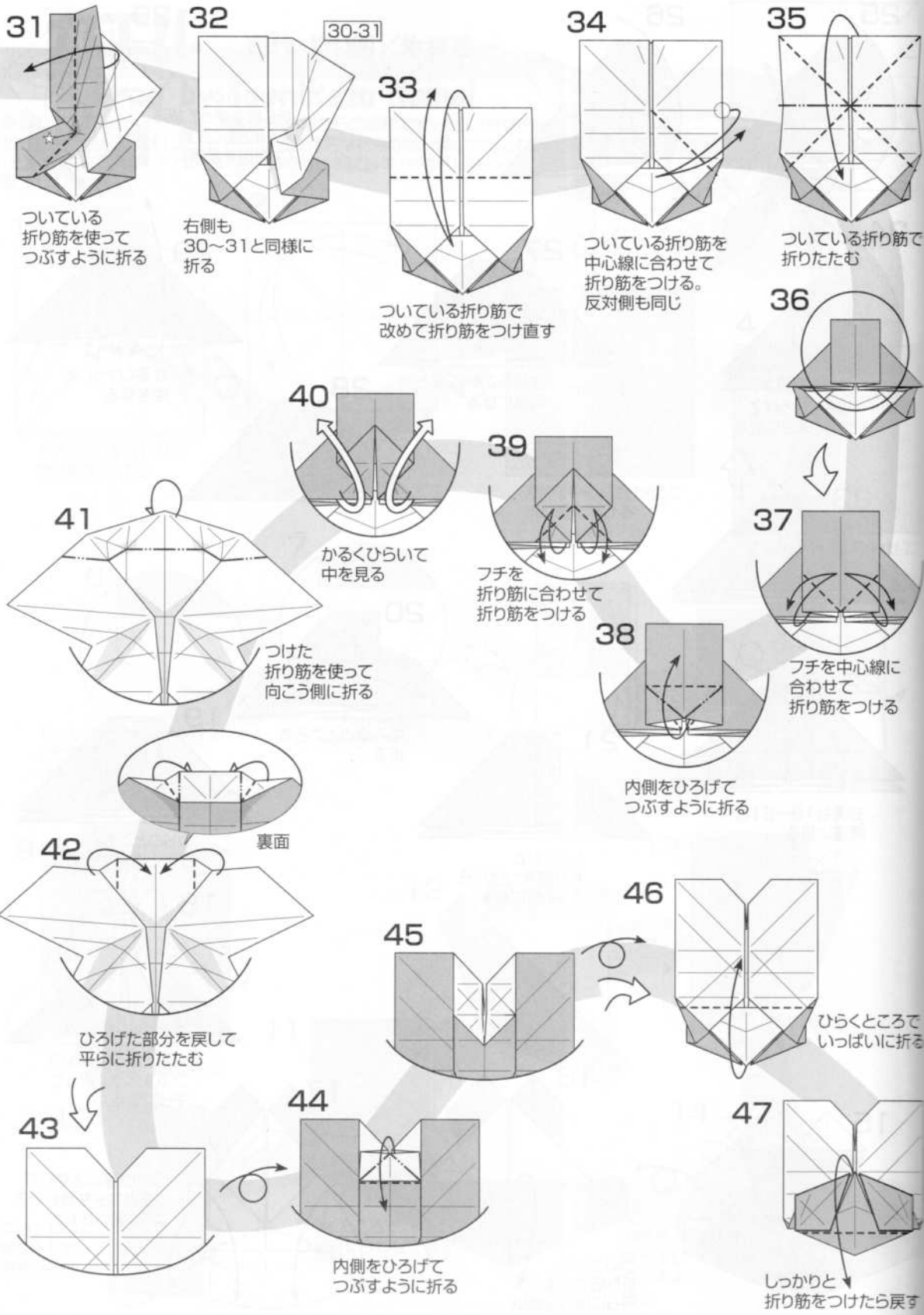

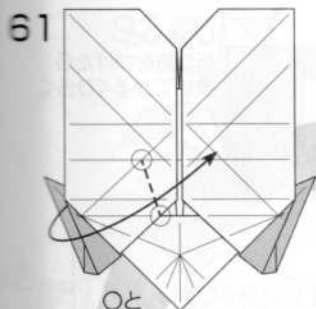

○と
○を結んで折る。
平らにはならない

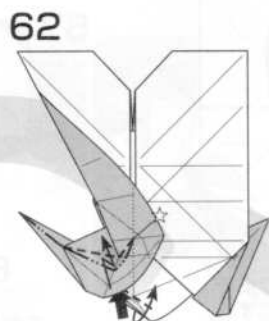

ついている折り筋を使って
つぶすように段折り。
☆の位置は中心線の
真上になる

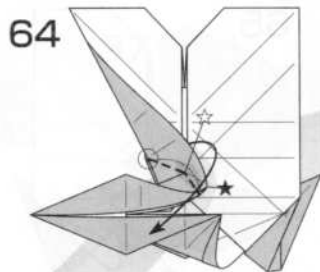

○と☆を結んで
つぶすように折る。
※★のカドは
中心線になる

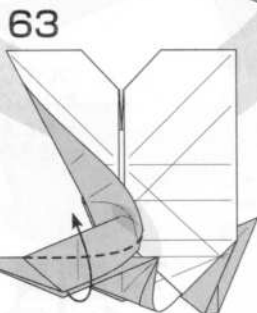

ついている折り筋で
折る

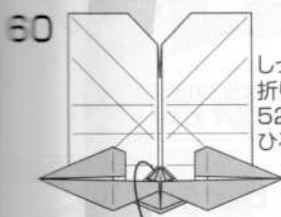

しっかりと
折り筋をつけたら
52の形まで
ひろげる

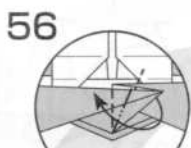

内側をひろげて
つぶすように折る

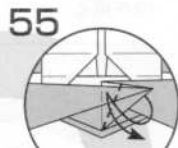

フチを折り筋に
合わせて折り筋を
つける

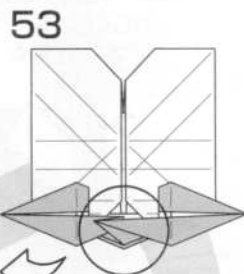

山谷を逆にして
内側のカドを
こちら側に出す

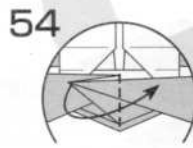

カドを折り返す

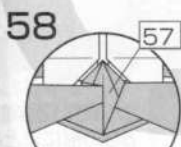

右側も57と
同様に折る

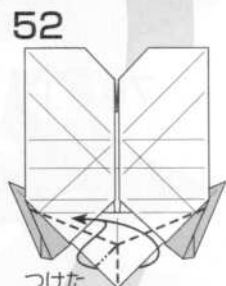

つけた
折り筋でつまみ折り

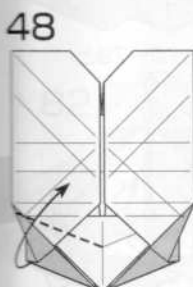

ついている折り筋で
折る

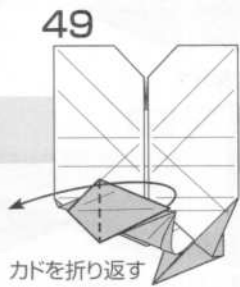

カドを折り返す

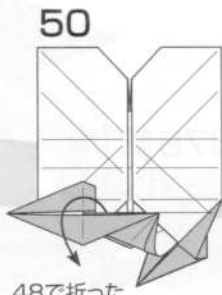

48で折った
部分に戻す

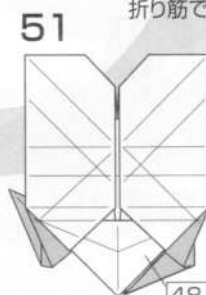

右側も
48~50と
同様に
折る

48-50

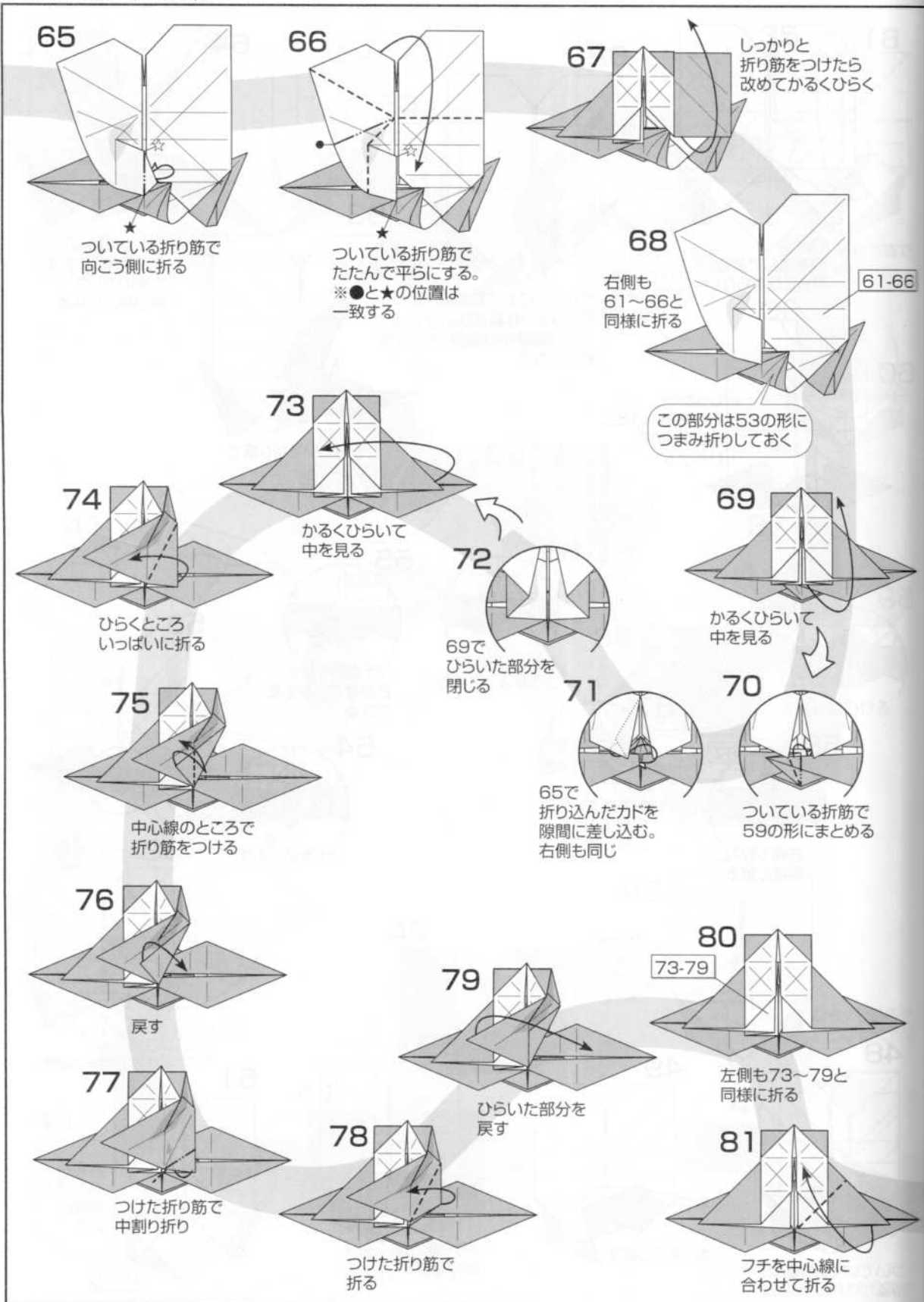

93



右側も
92と同様に折る

94

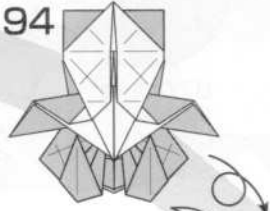

97

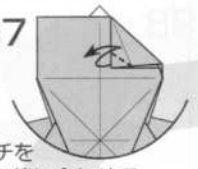

フチを
折り筋に合わせて
折り筋をつける

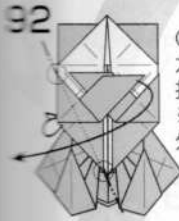

○と○を結んで
カドを向こう側のすき間に
折る。
※手前側は折らずに
外側に出す

95

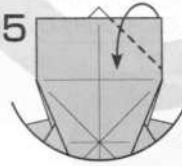

向こう側の
フチのところで
折る

96



フチと
フチを合わせて
折り筋をつける

91

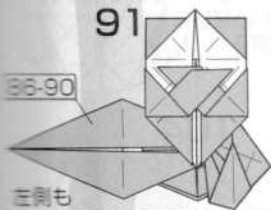

三側も
86~90と同様に折る

90



カドを
フチに合わせて
つぶすように折る

87

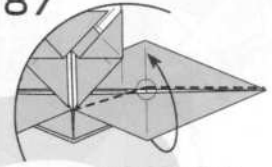

ひらくところで
いっぱい折る。
平らにはならない

88

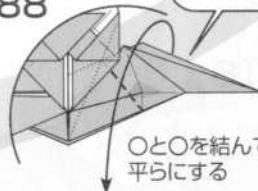

○と○を結んで折って
平らにする

裏面

89

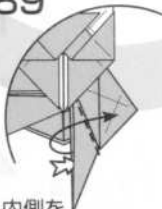

内側を
ひらいて折る

86

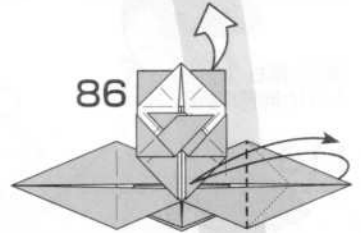

ついている折り筋で
向こう側のカドも
同時に折り筋をつける

82

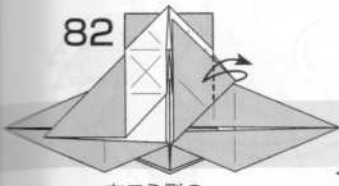

向こう側の
フチのところで
折り筋をつける

83

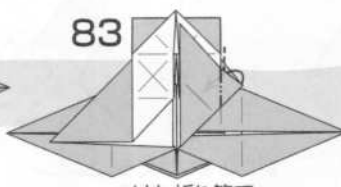

つけた折り筋で
中割り折り

84

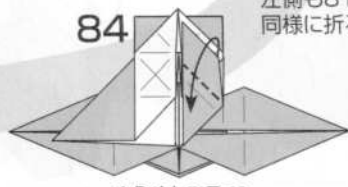

ひらくところで
いっぱい折る

85

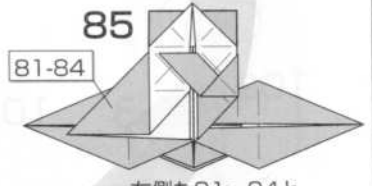

左側も81~84と
同様に折る

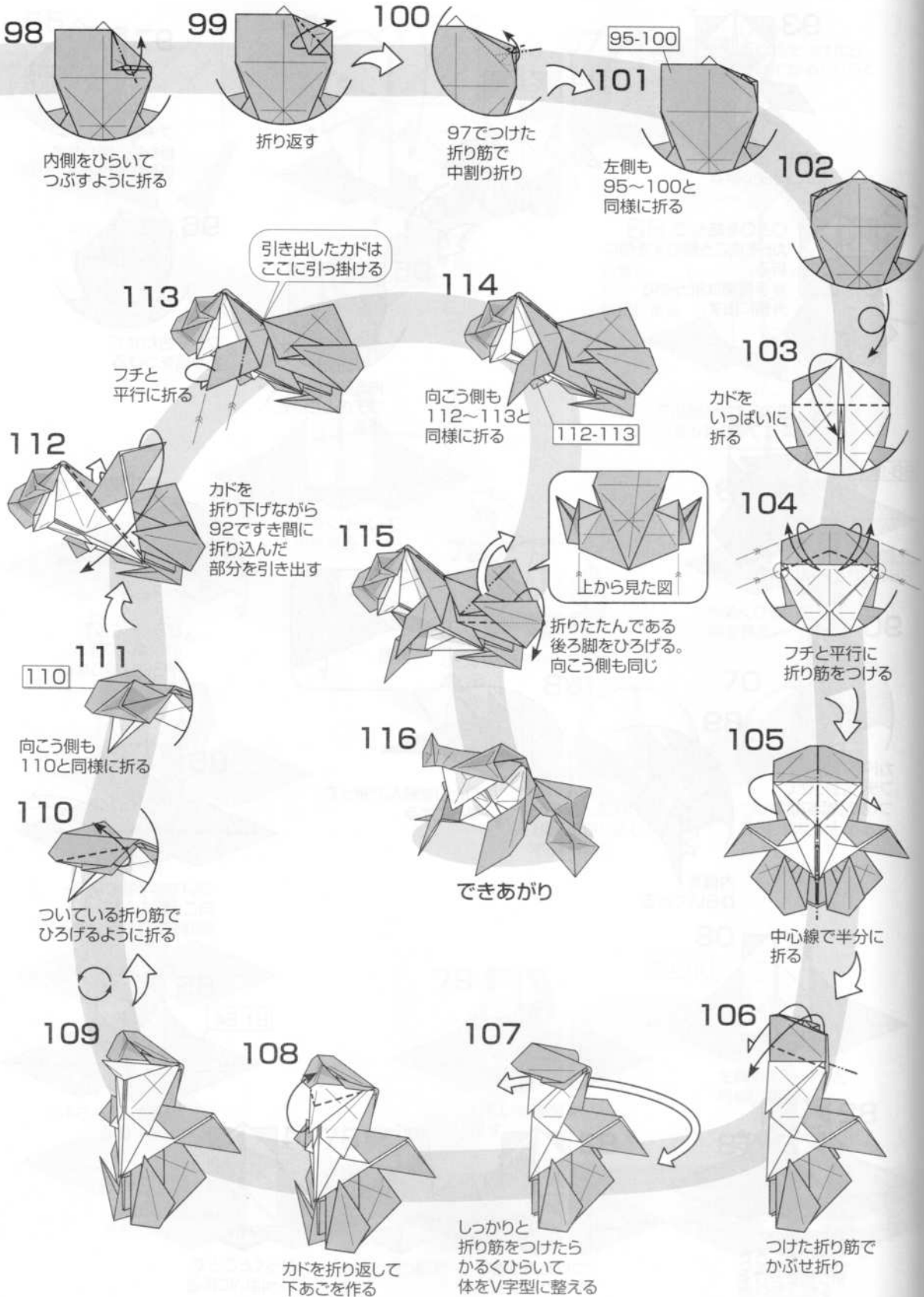

ねずみ2

Mouse 2

小松英夫

Komatsu Hideo

Model: Dec. 2019

Diagrams: Apr. 2023

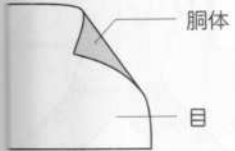
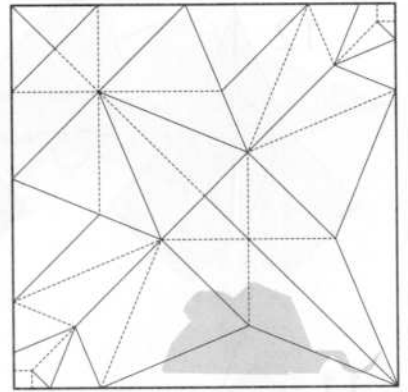
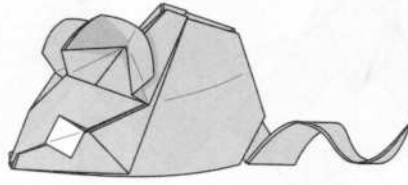

胴体 紙の表 (図で灰色の方) → 胴体の色
紙の裏 (図で白い方) → 目の色
になります

目

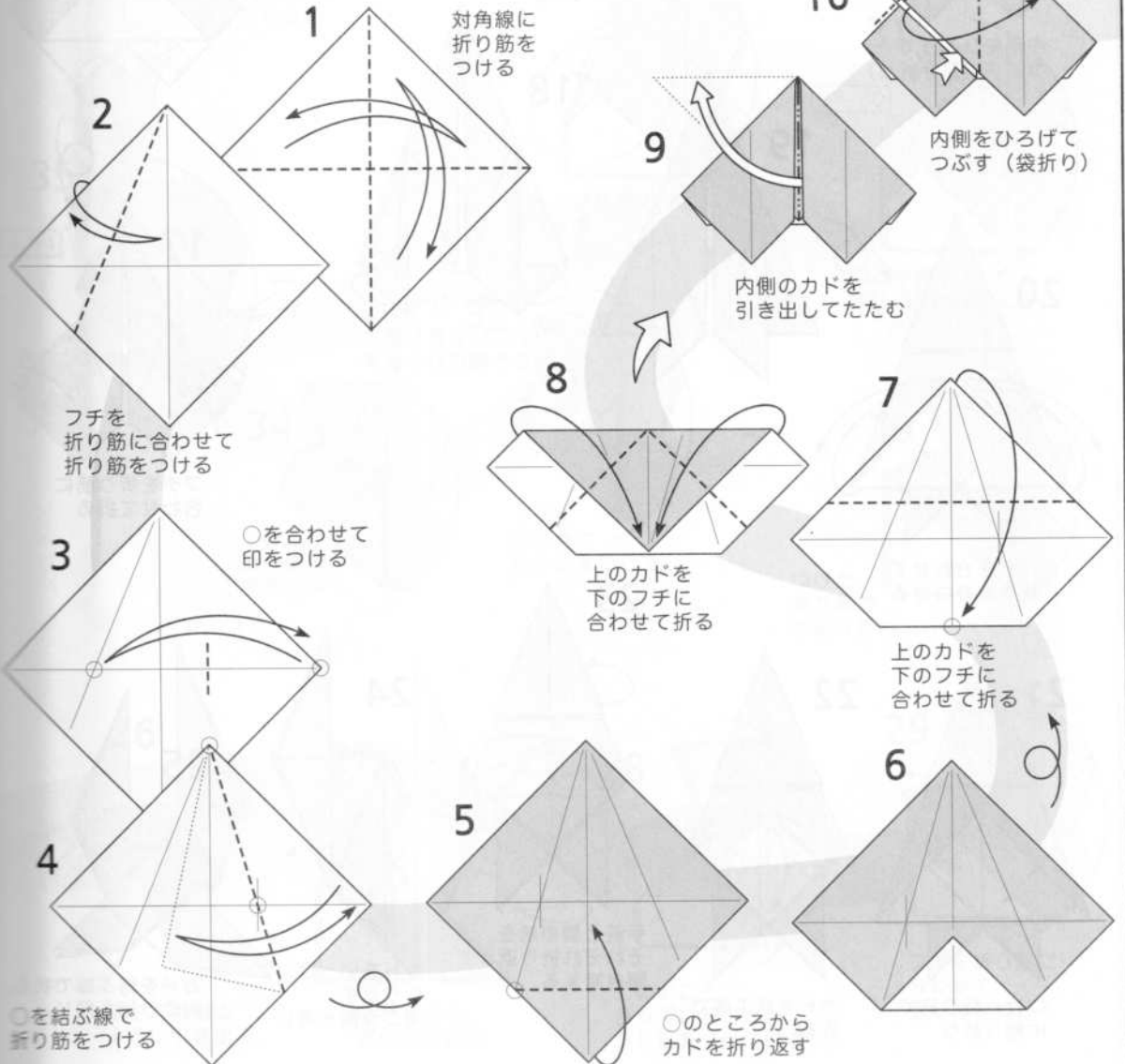

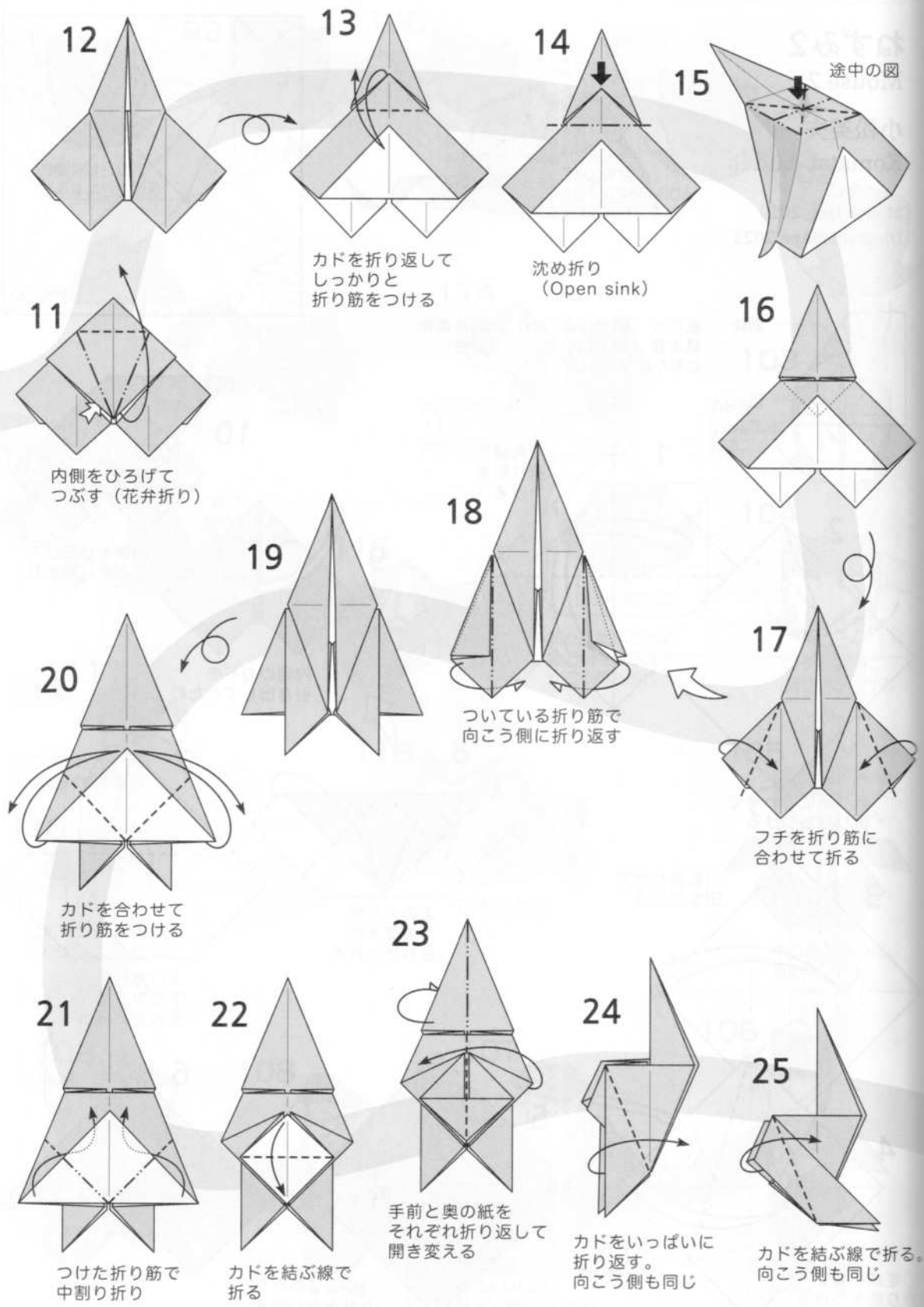

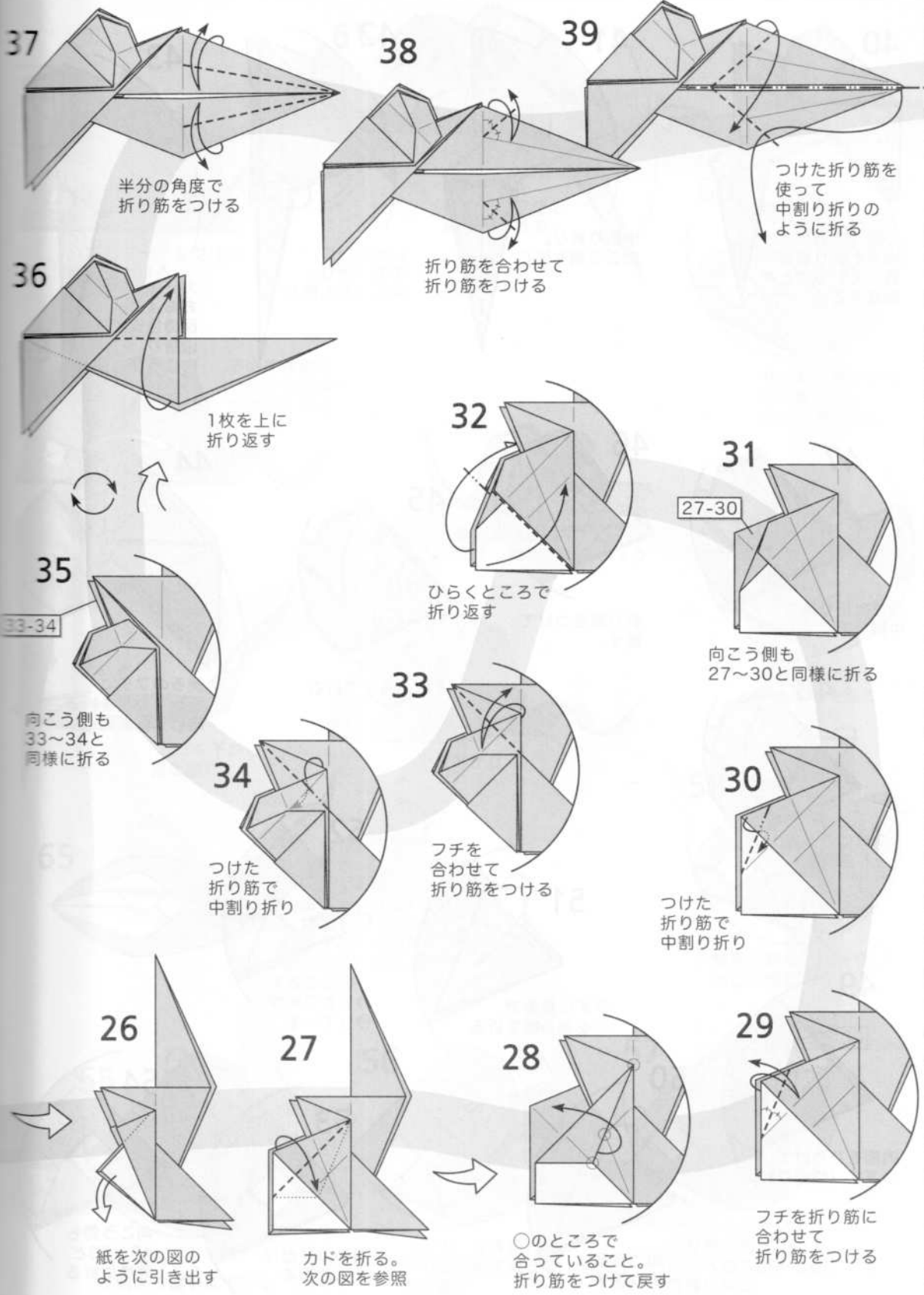

37
 半分の角度で
 折り筋をつける

38
 折り筋を合わせて
 折り筋をつける

39
 つけた折り筋を
 使って
 中割り折りの
 ように折る

36
 1枚を上
 に
 折り返す

32
 ひらくところ
 で
 折り返す

31
 27-30
 向こう側も
 27~30と同様に折る

35
 33-34
 向こう側も
 33~34と
 同様に折る

33
 フチを
 合わせて
 折り筋をつける

30
 つけた
 折り筋で
 中割り折り

34
 つけた
 折り筋で
 中割り折り

26
 紙を次の図の
 ように引き出す

27
 カドを折る。
 次の図を参照

28
 ○のところ
 で
 合っていること。
 折り筋をつけて戻す

29
 フチを折り筋に
 合わせて
 折り筋をつける

40

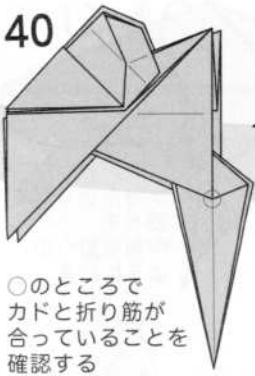

○のところで
カドと折り筋が
合っていることを
確認する

41

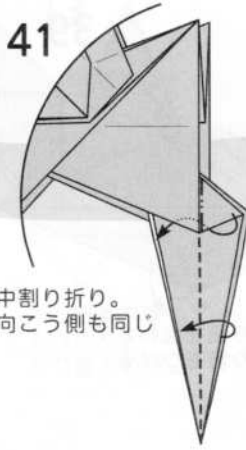

中割り折り。
向こう側も同じ

42

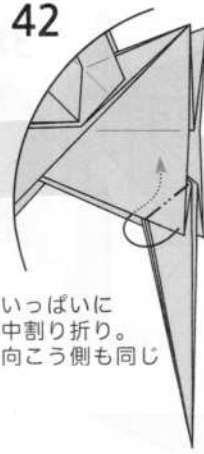

いっぱい
中割り折り。
向こう側も同じ

43

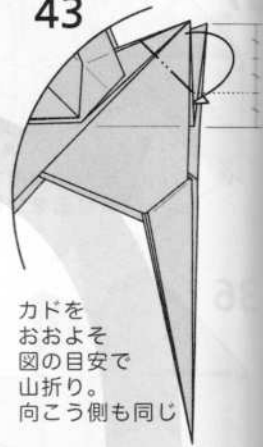

カドを
おおよそ
図の目安で
山折り。
向こう側も同じ

47

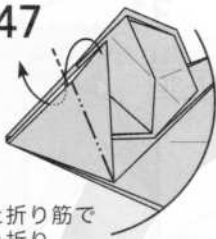

つけた折り筋で
中割り折り

46

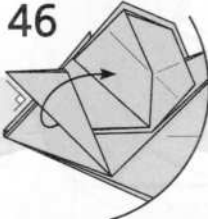

折り筋をつけて
戻す

45

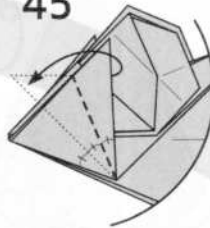

1/3の角度で折る

44

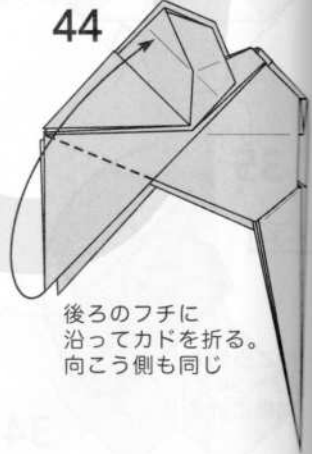

後ろのフチに
沿ってカドを折る。
向こう側も同じ

48

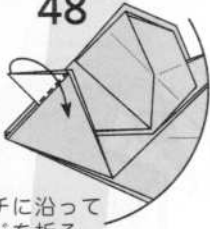

フチに沿って
カドを折る

51



フチに垂直で、
○を通る線で折る

52



○のところで
カドとフチが
合っている

49

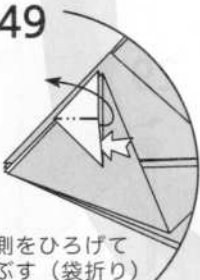

内側をひろげて
つぶす (袋折り)

50

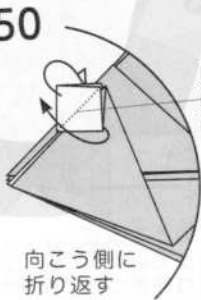

向こう側に
折り返す

53



奥のカドだけ
後ろに折る

54



向こう側も
45~53と
同様に折る

62

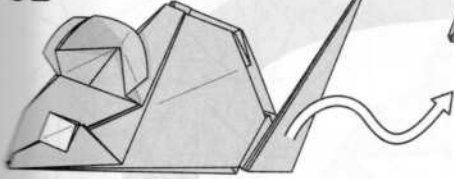

カドにカーブをつけて
尾を仕上げる

61

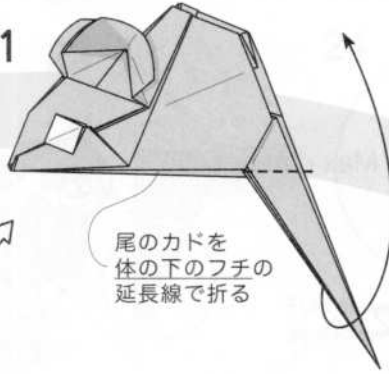

尾のカドを
体の下のフチの
延長線で折る

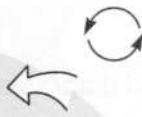

60

耳に丸みをつけて
形を整える。
向こう側も同じ

63

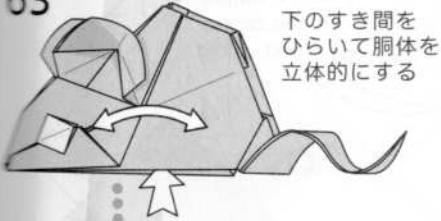

下のすき間を
ひらいて胴体を
立体的にする

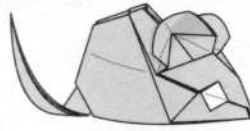

●尻尾は自由に
表情づけしてみましょう

59

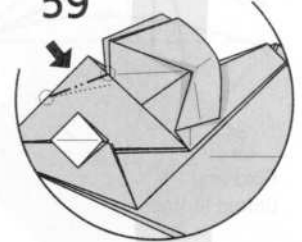

押し込むように
中央のすき間に
中割り折り

64

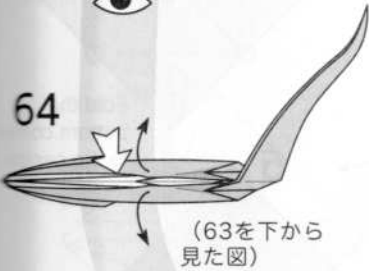

(63を下から
見た図)

66

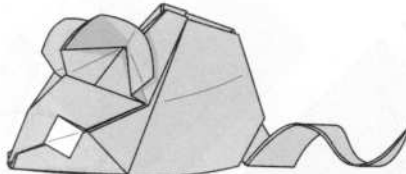

できあがり

58

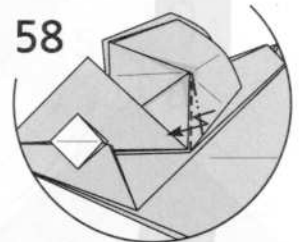

根元で斜めに段折り。
向こう側も同じ

65

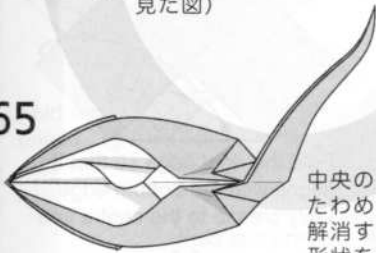

中央のヒダはS字状に
たわめて、つかえを
解消すると同時に、
形状を固定する

55

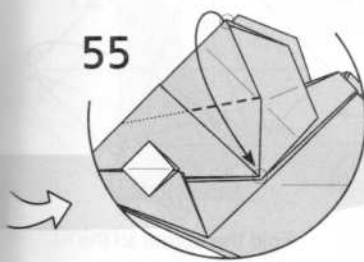

○を合わせて
左側から途中まで折る

56

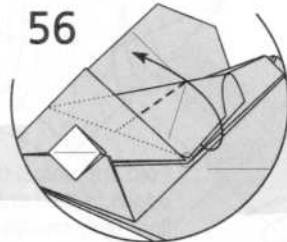

(以下、立体図)
次の図に示す目安で
折り返す

57

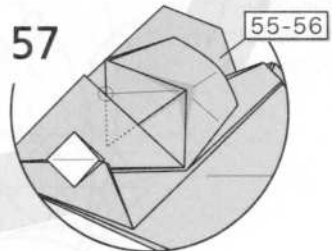

○のところでフチと
折り筋が合う。
向こう側も55~56と
同様に折る

55-56

Cat

Design and diagrams by Max d'Anger

Designed: 31.05.2017

Diagrammed: 06.2017

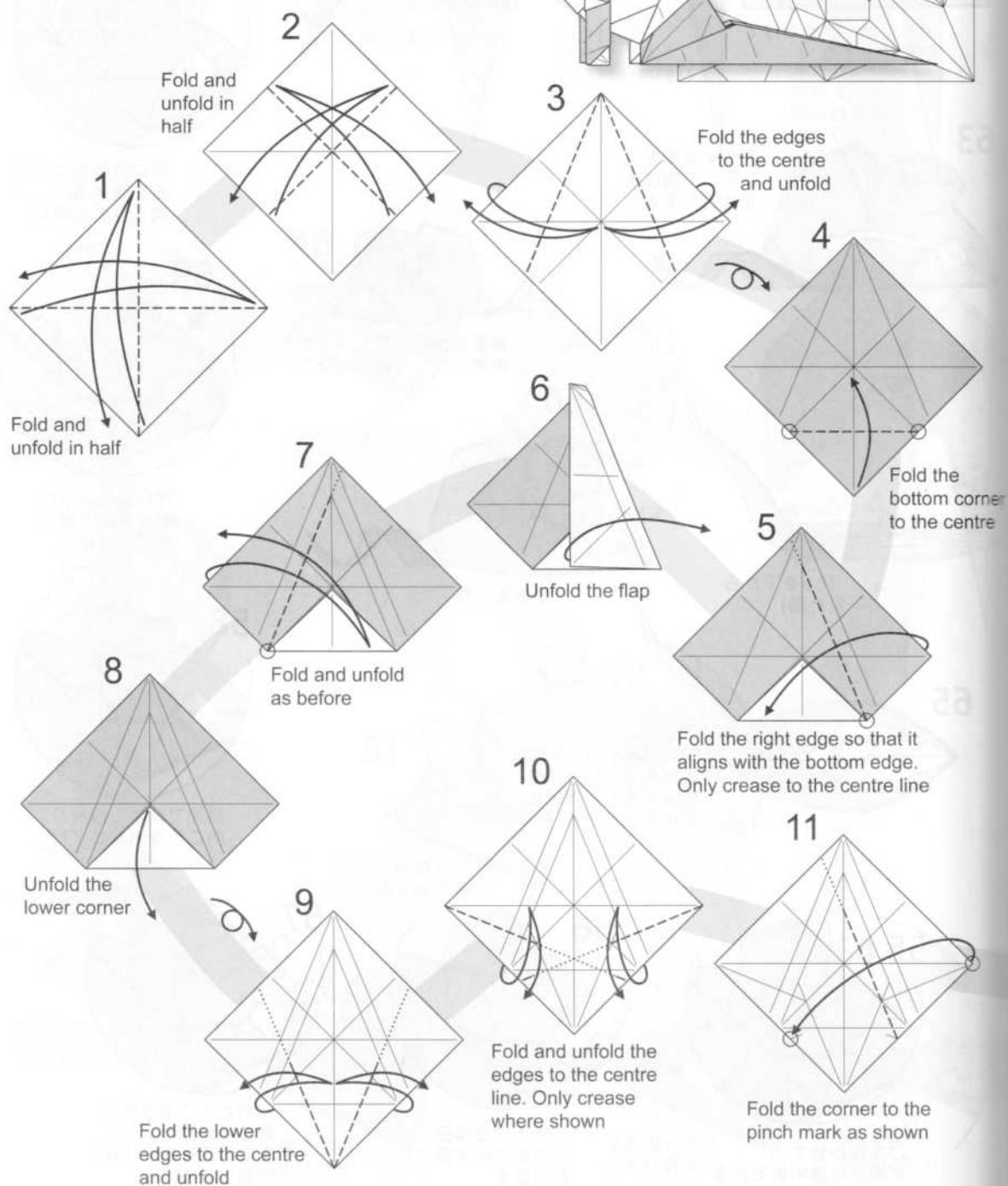
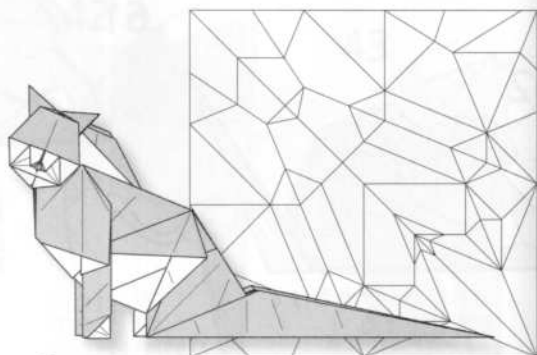

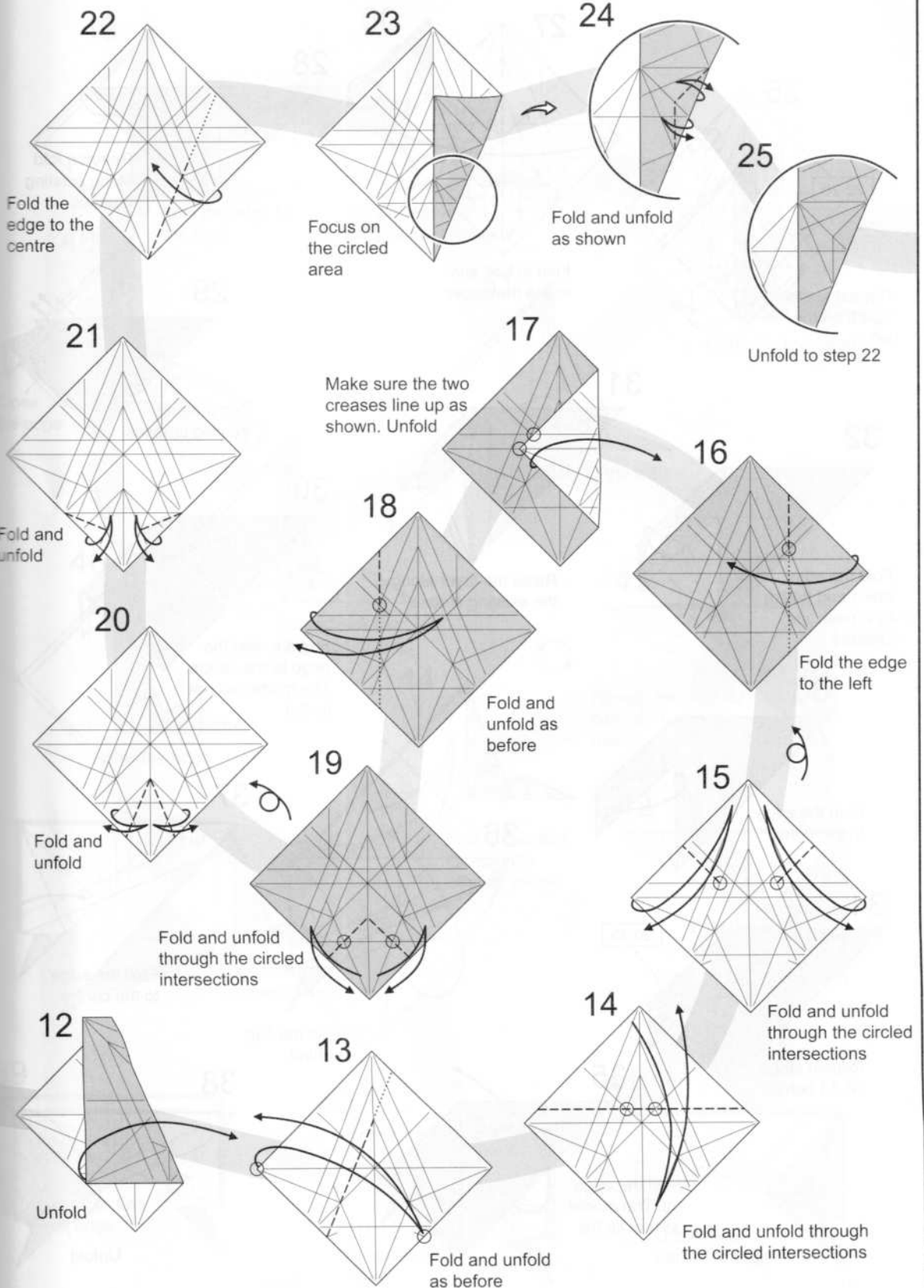

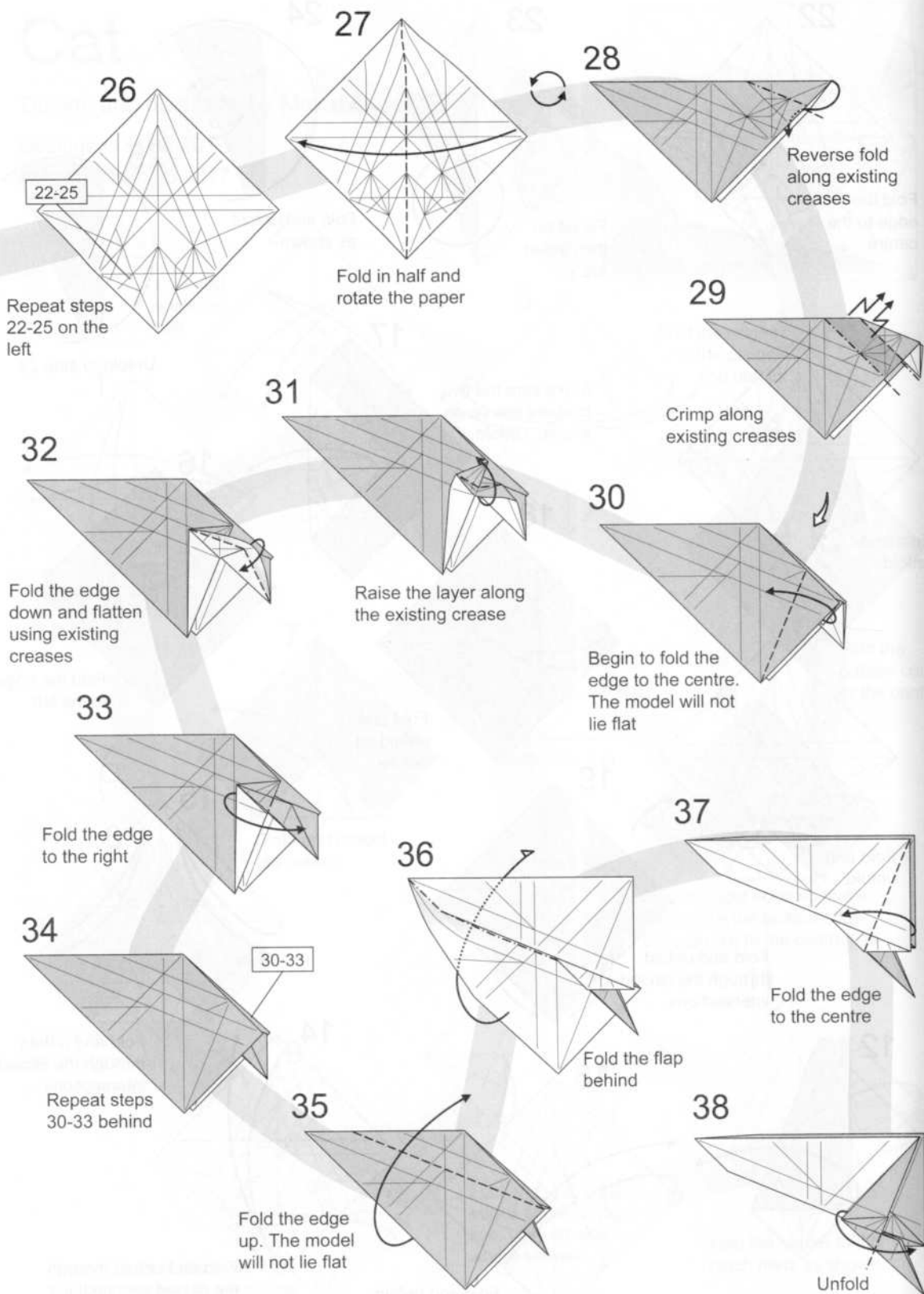

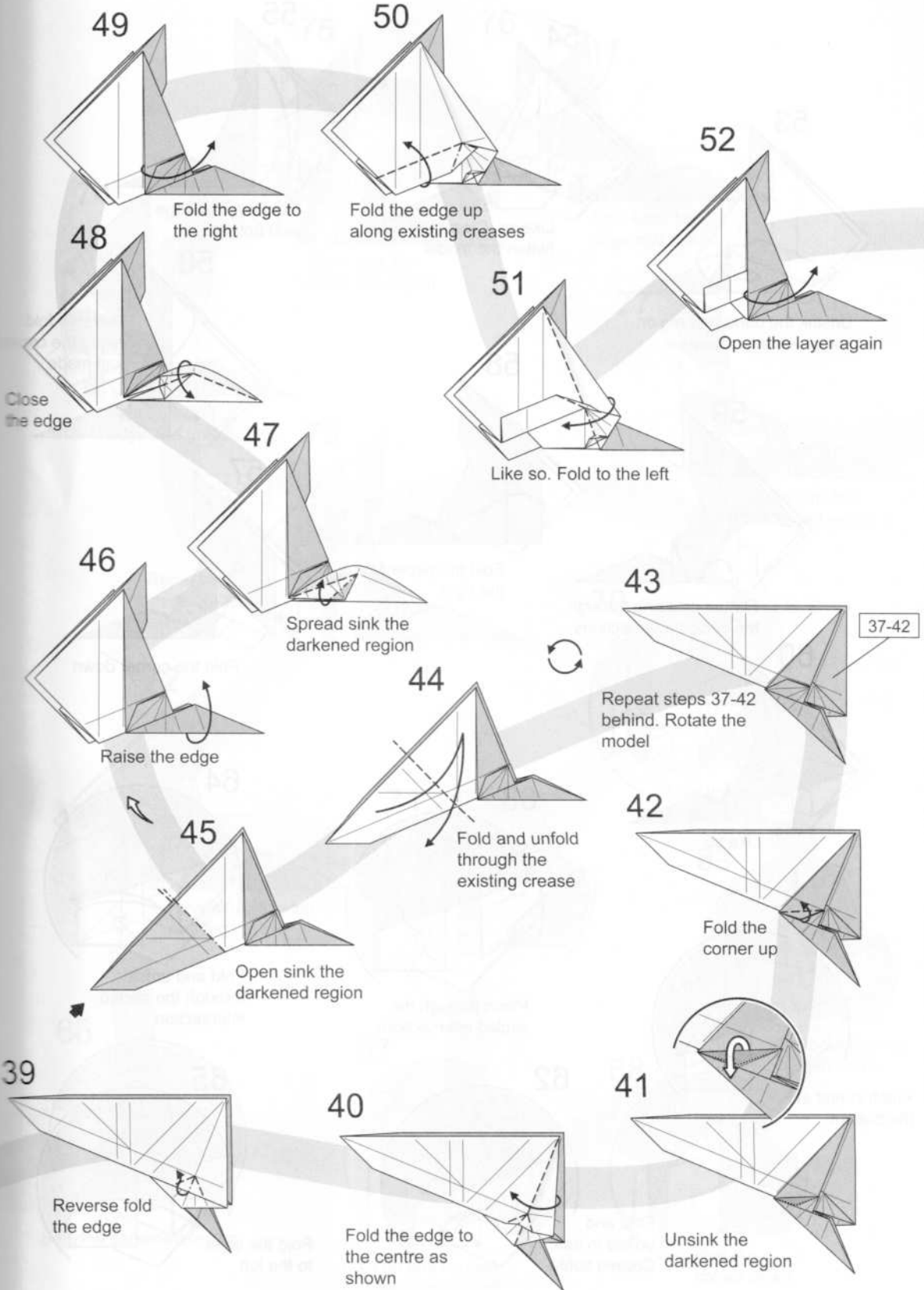

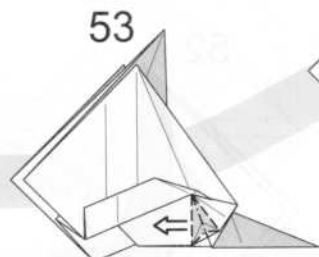

53
Unsink the darkened region using existing creases

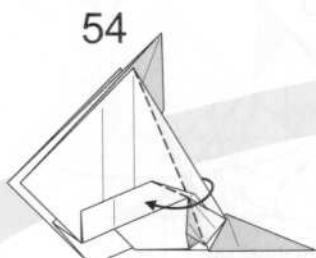

54
Like so. Close and flatten the model

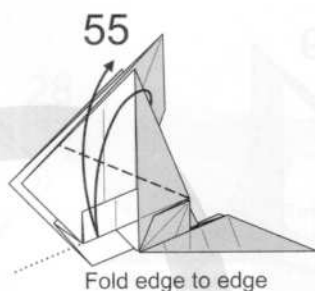

55
Fold edge to edge and unfold

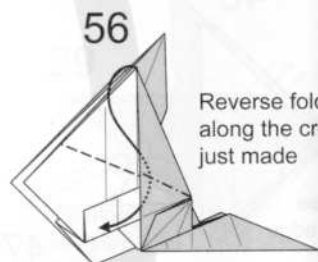

56
Reverse fold along the crease just made

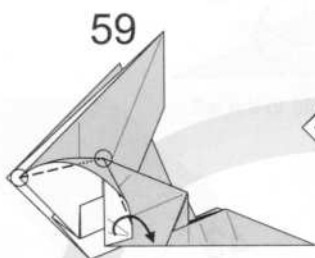

59
Flatten creasing through the circled intersections

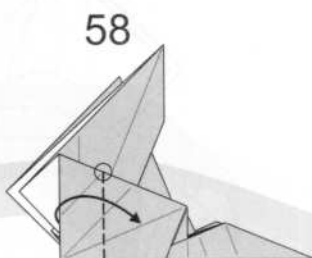

58
Fold the paper to the right

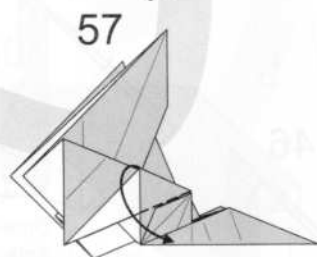

57
Fold the corner down

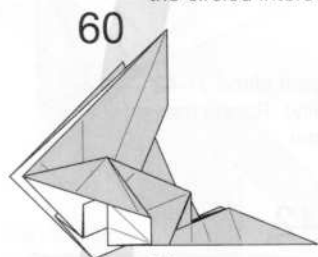

60
Like so

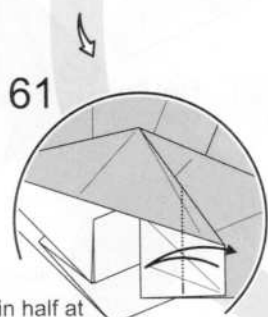

61
Pinch in half at the bottom

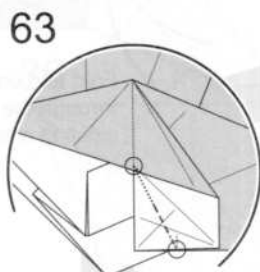

63
Pinch through the circled intersections

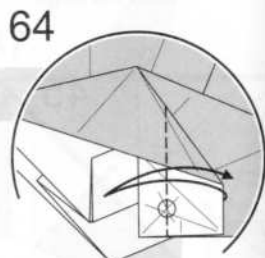

64
Fold and unfold through the circled intersection

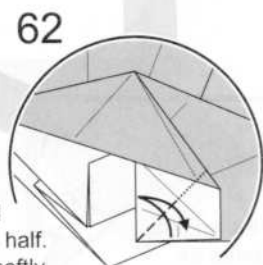

62
Fold and unfold in half. Crease softly

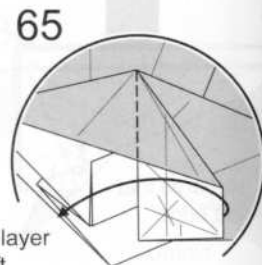

65
Fold the layer to the left

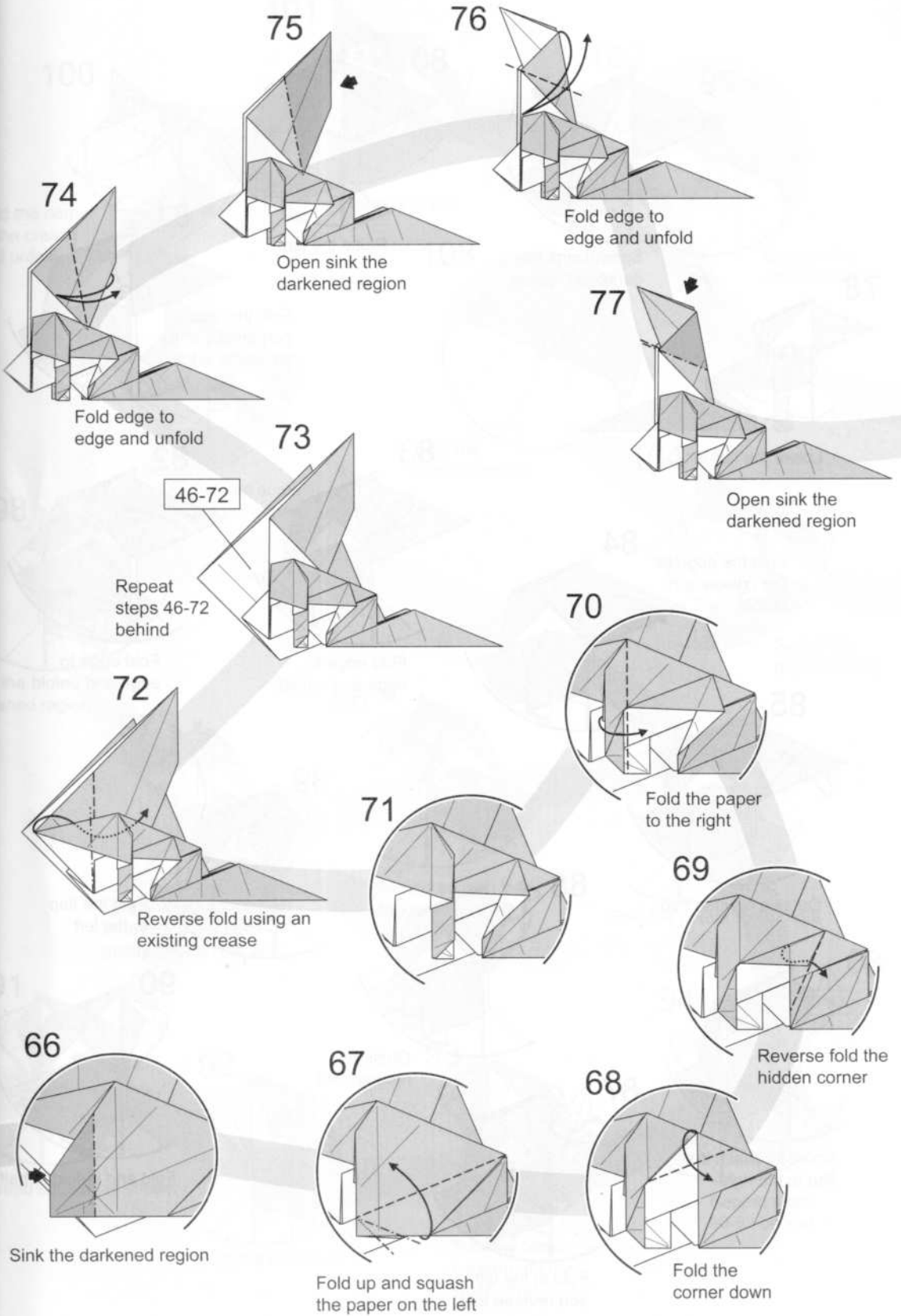

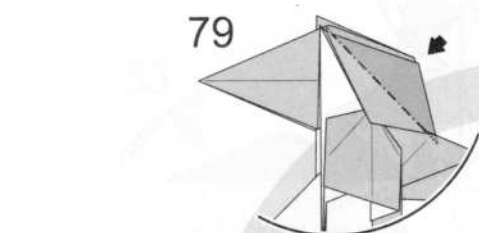

78

Lower the corner

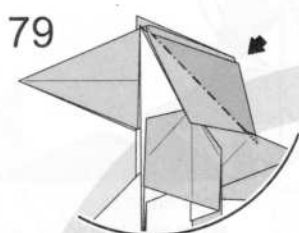

79

Spread sink the darkened region

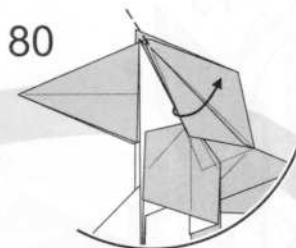

80

Raise the flap

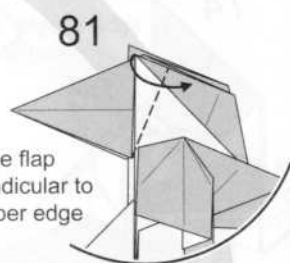

81

Fold the flap perpendicular to the upper edge



83

Fold edge to edge and unfold



82

Fold edge to edge and unfold



84

Fold the edge to the crease and unfold

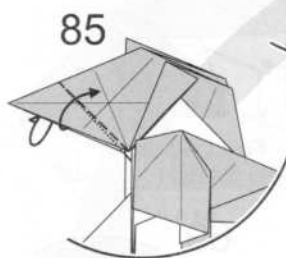

85

Outside reverse fold



88

Outside reverse fold



89

Fold the flap to the left

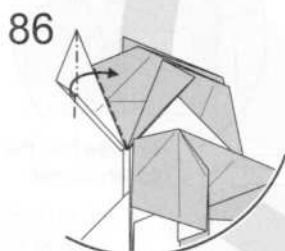

86

Spread squash the flap to the right



87

Fold to the left and reverse fold

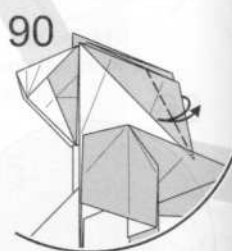

90

Fold and unfold in half

100

Fold the corner to the crease and unfold

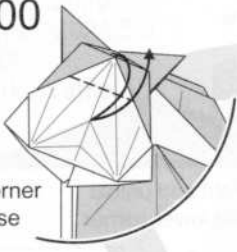

101

Rabbit ear fold

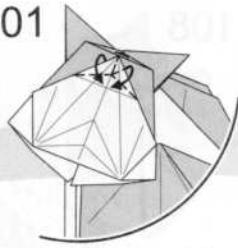

102

Squash the small corner

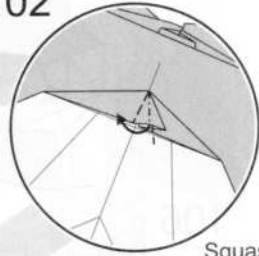

99

Pull out some hidden paper

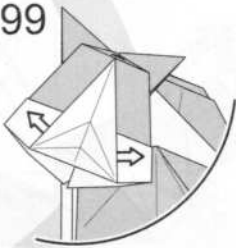

103

Fold the corner behind

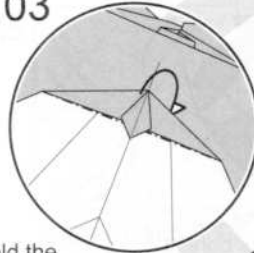

104

Swivel the paper behind

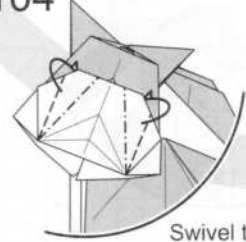

98

Sink the darkened region

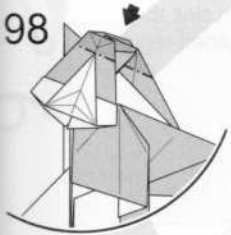

97

Fold and unfold through all layers but crease gently through the ears

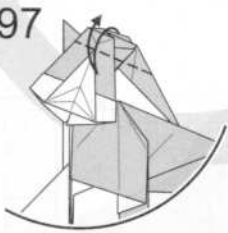

96

Spread squash the darkened region



95

Fold the corner to the right

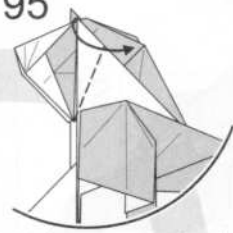

91

Spread squash as shown

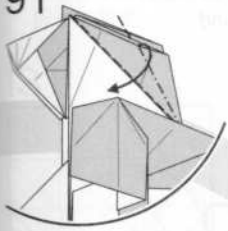

92

Fold the corner up



93

Tuck the corner underneath the white layer

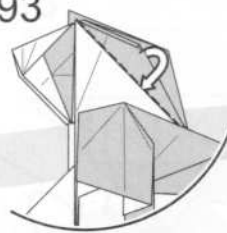

94

Repeat steps 90-93 behind



90-93

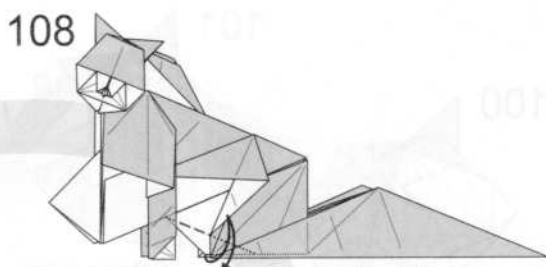
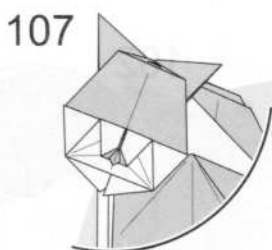

Fold and unfold
the lower corner

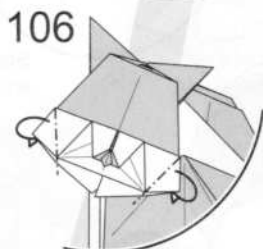

Fold the
corners behind



Open sink the
darkened region

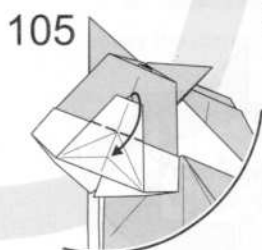

Fold the
paper down

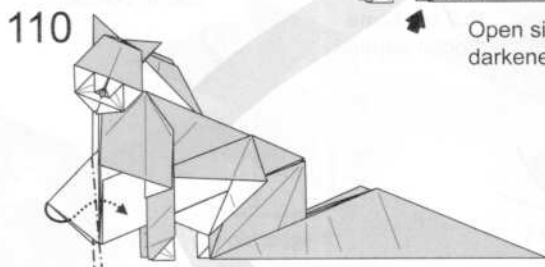

Reverse fold the corner

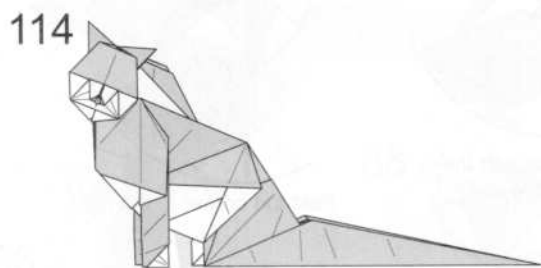

Finished

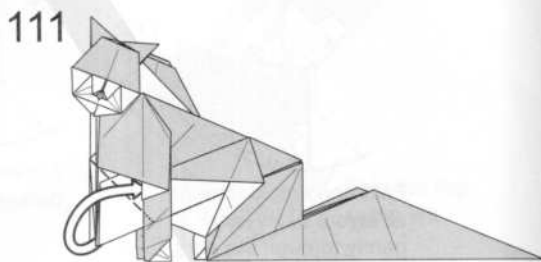

Tuck the corner inside.
Repeat behind

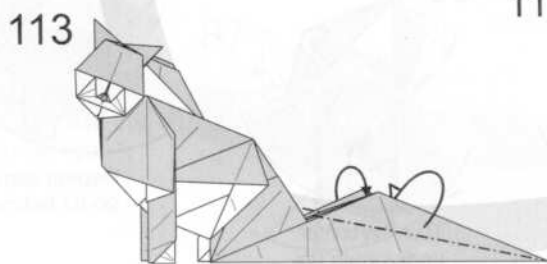

Thin the tail

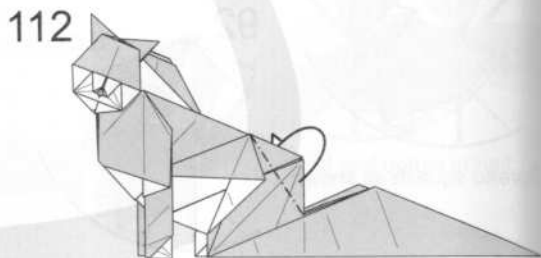

Fold the corner inside the
body. Repeat behind

Created 2020
 Diagrams 2024.5.3
 山北克彦
 Katsuhiko Yamakita

うさぎ

rabbit

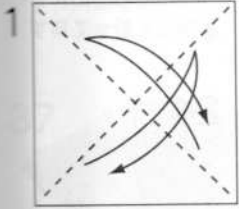
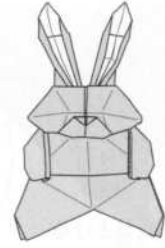
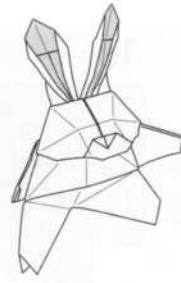

三角に折って戻す

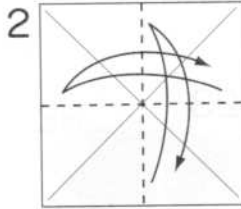

四角に折って戻す

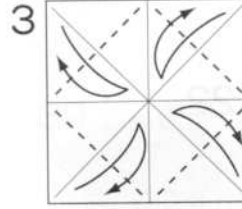

角を中心に折って戻す

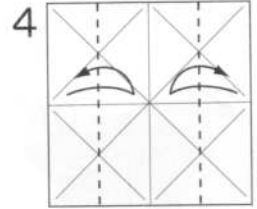

観音折りして戻す

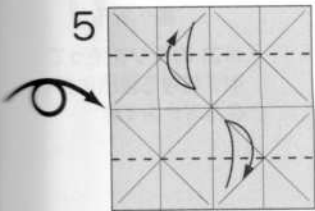

観音折りして戻す

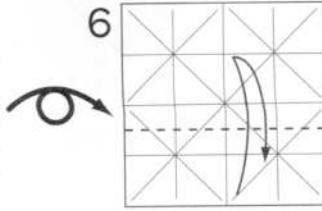

縁を折り筋に合わせ折って戻す

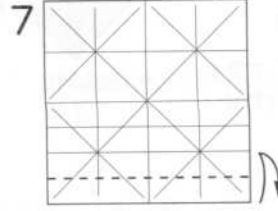

縁を折り筋に合わせ折って戻す

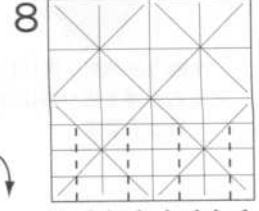

8等分になる折り筋を入れる

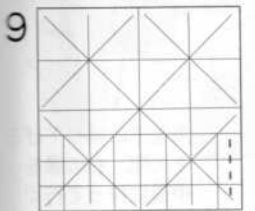

縁を折り筋に合わせ折って戻す

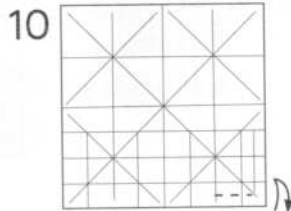

縁を折り筋に合わせ折って戻す

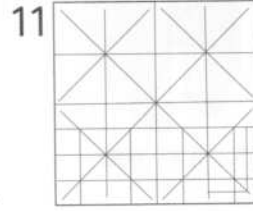

左も同じ (9-10)

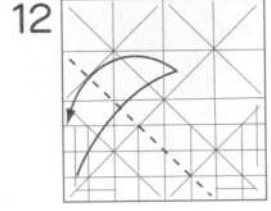

縁を折り筋に合わせ折って戻す

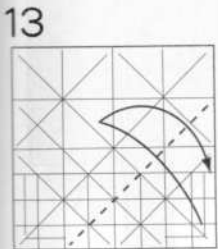

縁を折り筋に合わせ折って戻す

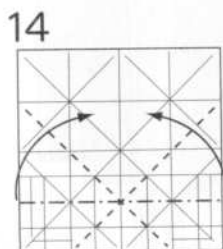

折り筋通り畳む

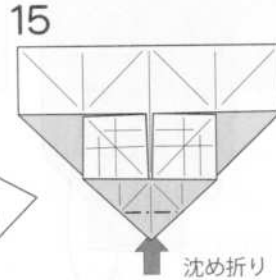
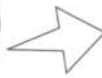

沈め折り

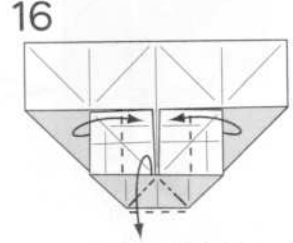

観音折りしながら縁を折り下げる

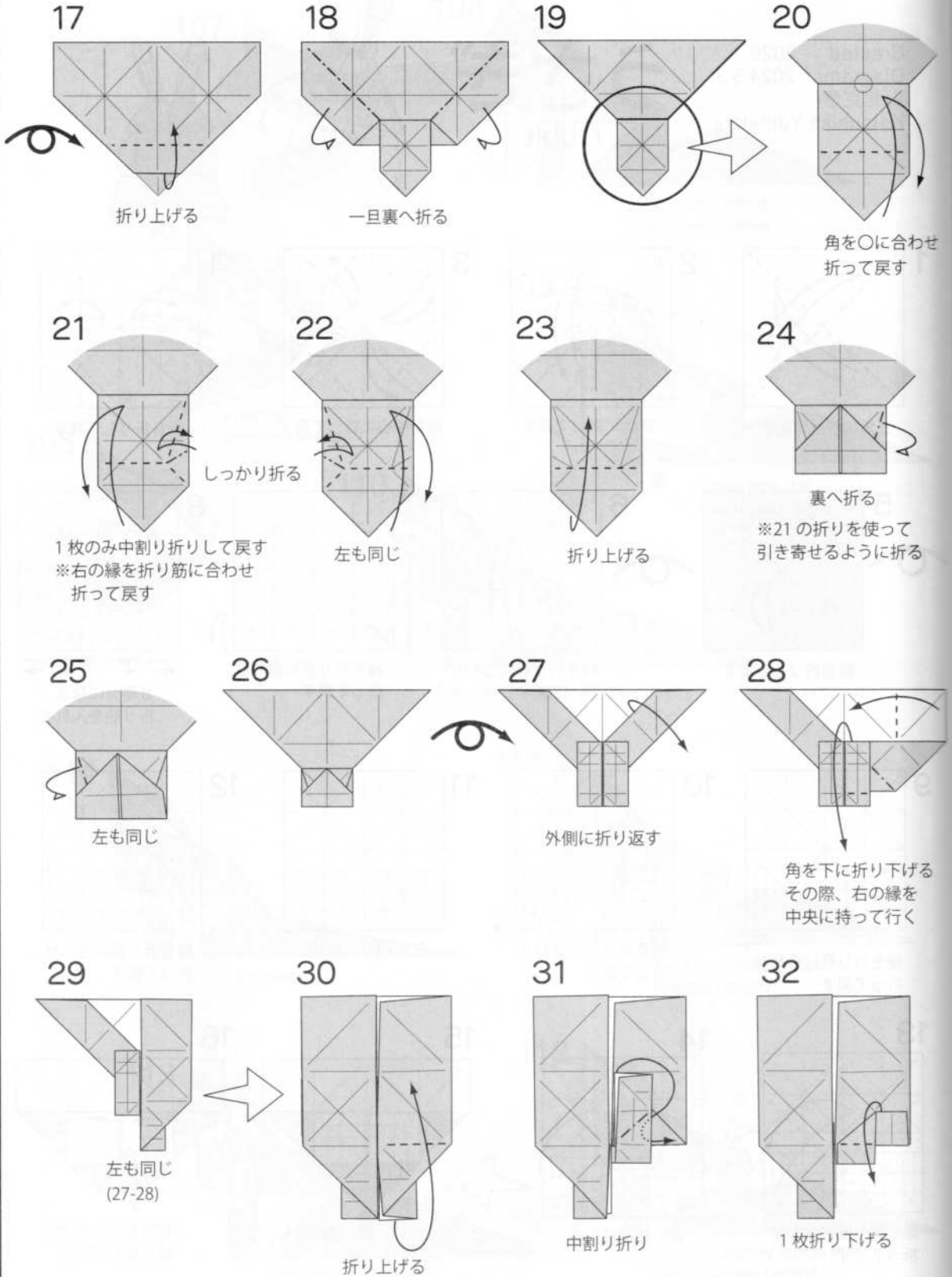

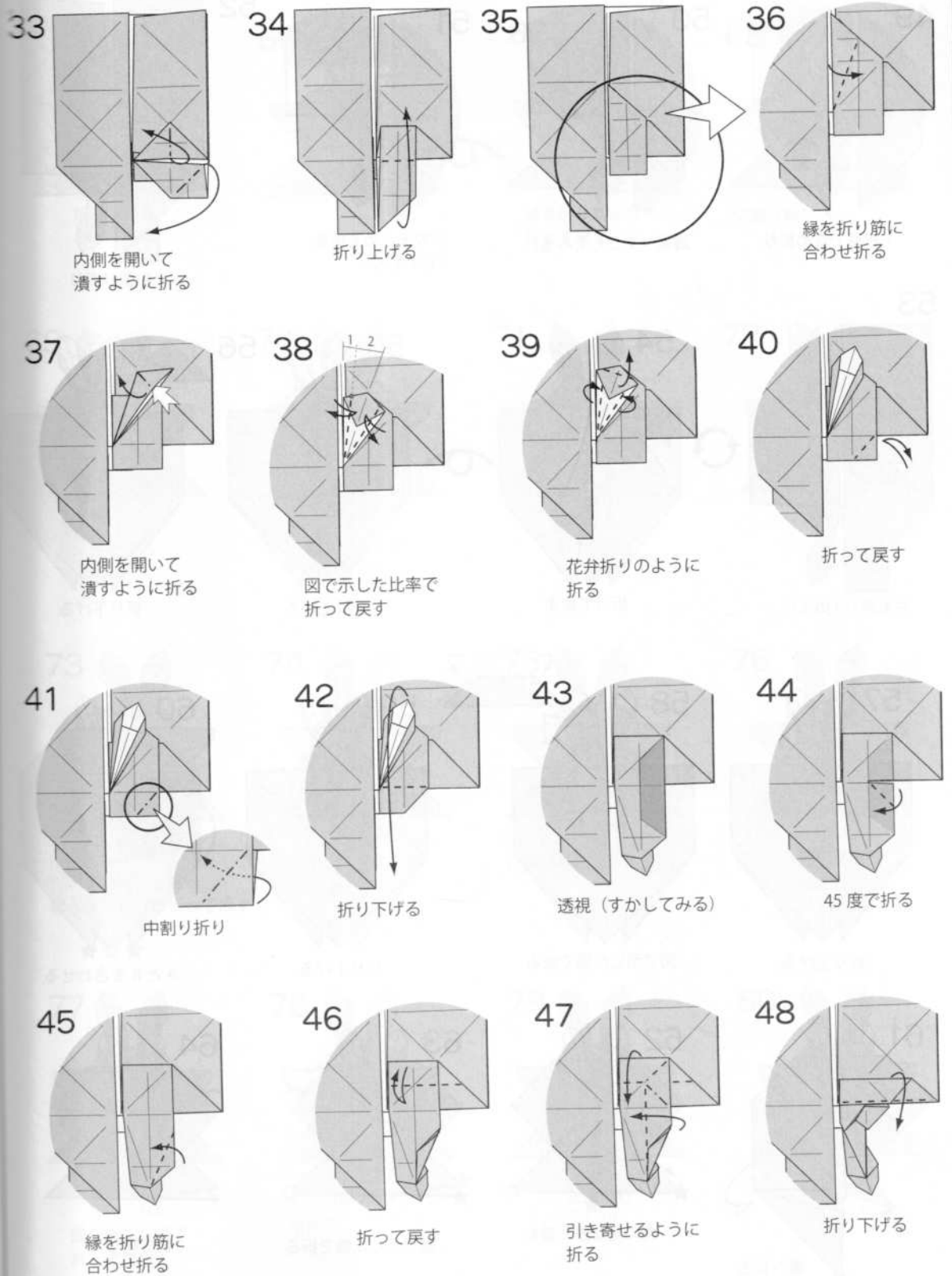

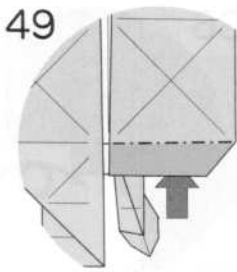

1枚目で沈め折り

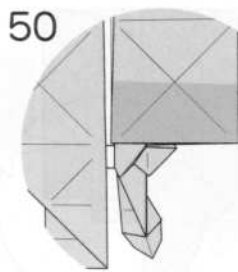

透視 (すかしてみる)

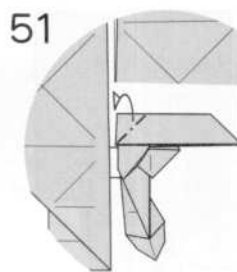

2枚まとめて折る
(止め折り)

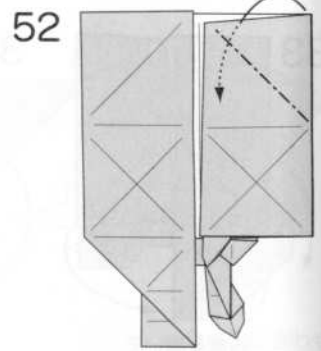

中割り折り

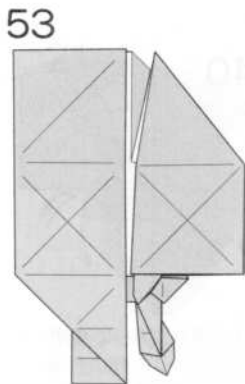

左も同じ (30-52)

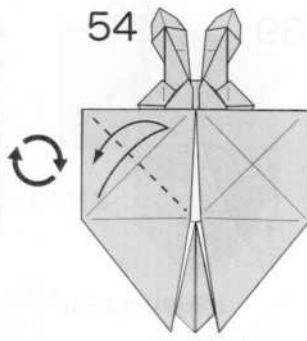

折って戻す

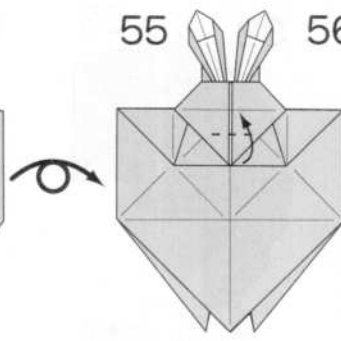

折り上げる

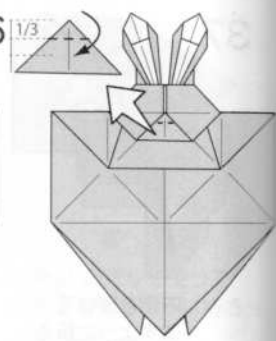

折り下げる

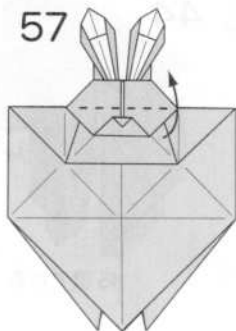

折り上げる

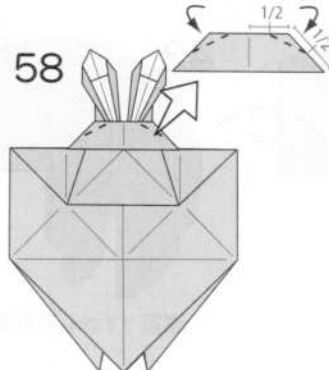

図で示した幅で折る

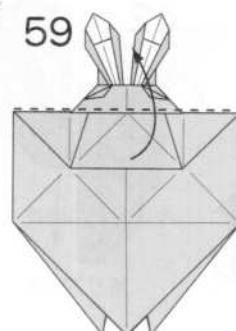

折り上げる

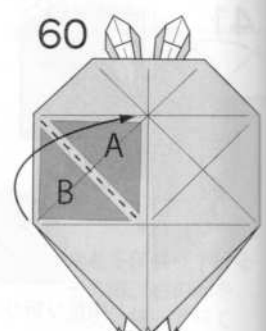

AとBを合わせる

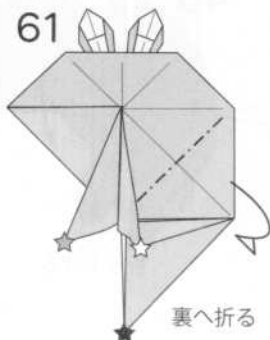

裏へ折る

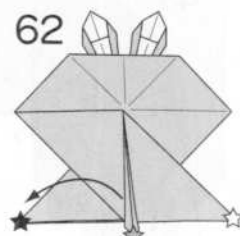

☆の角を左に畳む

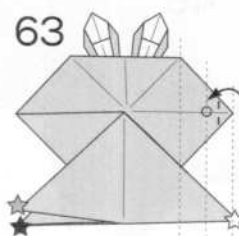

図で示した幅で折る

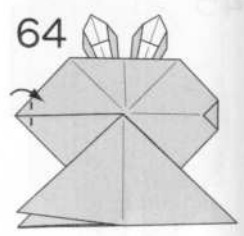

左も同じ

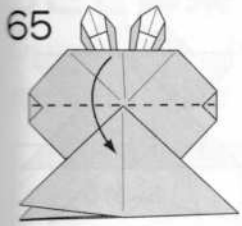

65

折り下げる

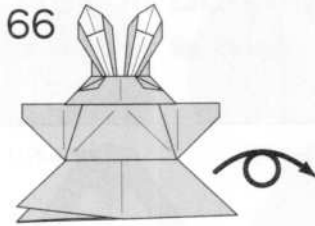

66

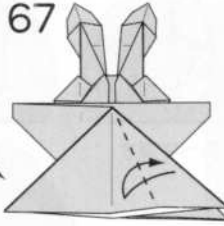

67

縁を折り筋に合わせ
折って戻す

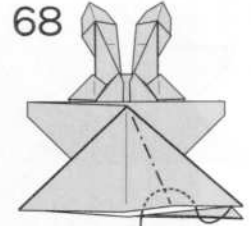

68

中割り折り

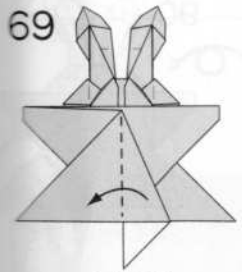

69

1枚折る

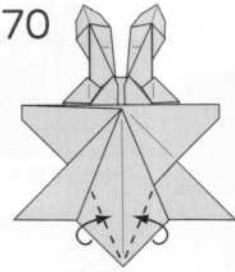

70

縁を折り筋に
合わせ折る

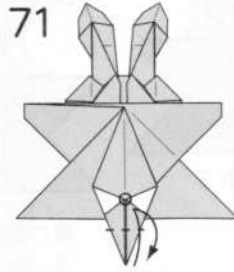

71

折って戻す

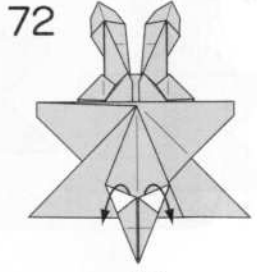

72

開く

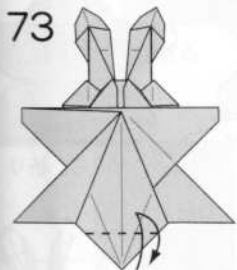

73

付いている折り筋を
延長するように折って戻す

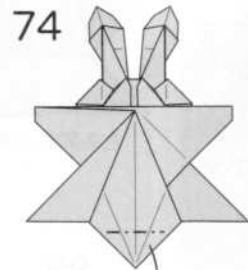

74

裏へ折る

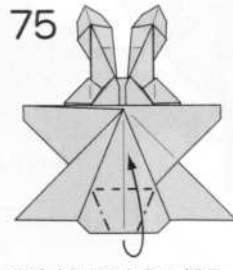

75

花弁折りのように折る

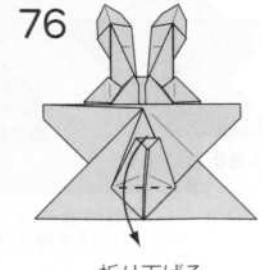

76

折り下げる

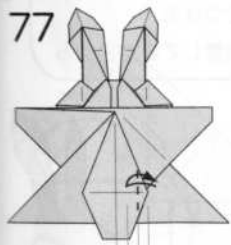

77

1/3
図で示した幅で
折って戻す

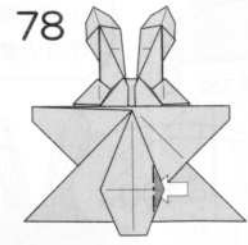

78

沈め折り

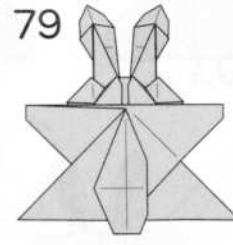

79

左も同じ
(77-78)

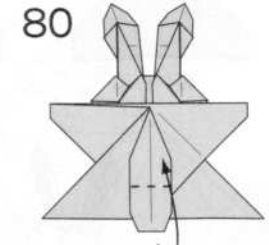

80

折り上げる

81

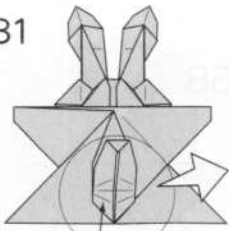

82では矢印で示した
折り筋と平行に折る

82

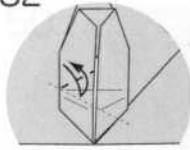

折って戻す

83

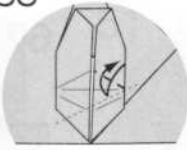

右も同じ

84

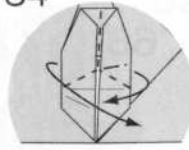

つまみ折り

85

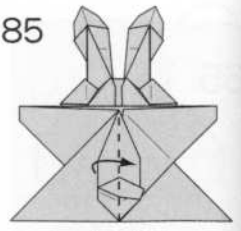

右に折る

86

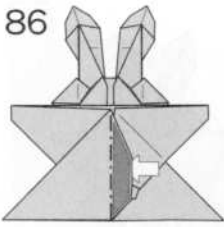

沈め折り

87

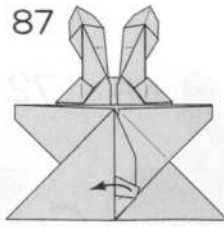

左に折る

88

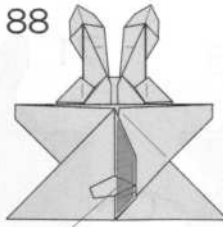

裏のポケットに
差し込む

89

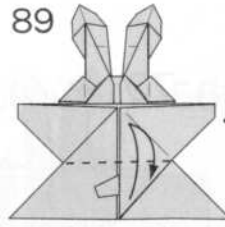

折って戻す

90

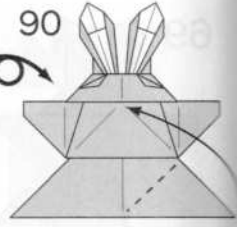

角を折り上げる

91

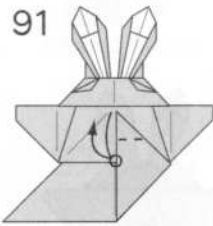

角を折って戻す

92

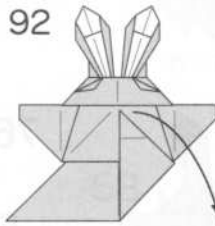

角を折り下げる

93

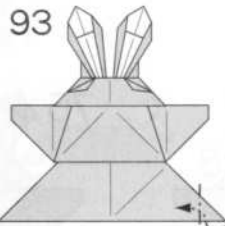

1枚目で中割り折り

94

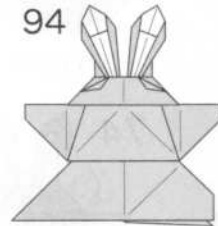

左も同じ (90-93)

95

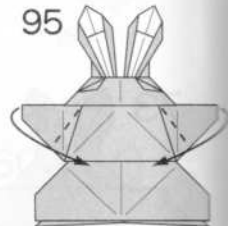

ぐらい折り

96

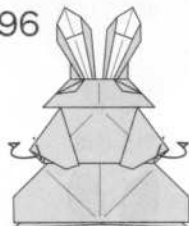

裏へ折る

97

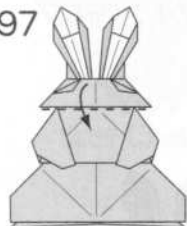

折り下げる

98

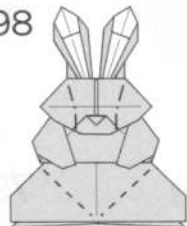

形を整える

99

- ① 顔を立体にする
- ② 耳に表情を加える
- ③ シッポを起こす
- ④ 股に角度をつける
- ⑤ ④と腰を調整して自立させる

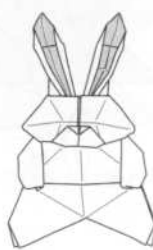
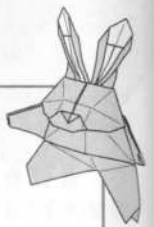

100

できあがり

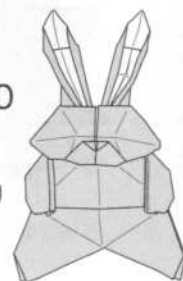

うさぎの栞 / Rabbit Bookmark

Created:2023/06 Diagrams:2024/05 By Kasumi

創作/作図 霞 誠志

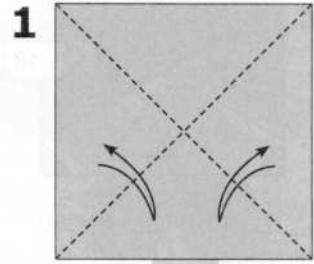
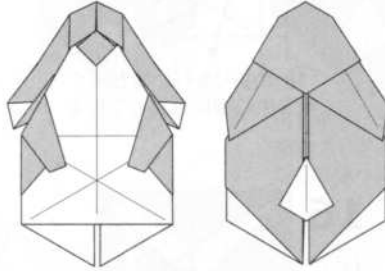
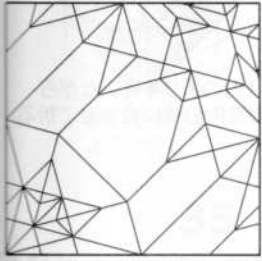

折り筋を付ける

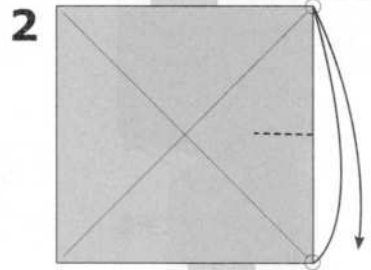

○印を合わせて
折り筋を付ける

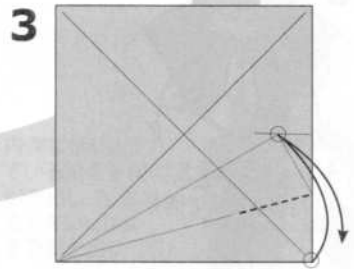

○印を合わせて
折り筋を付ける

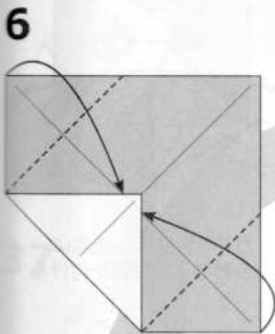

縁を合わせて折る

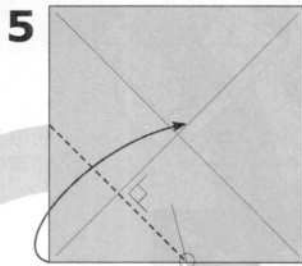

○印を通る線で折る

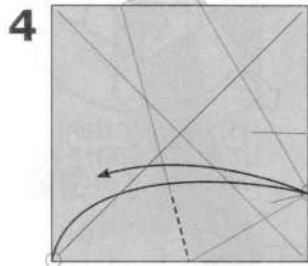

○印を合わせて
折り筋を付ける

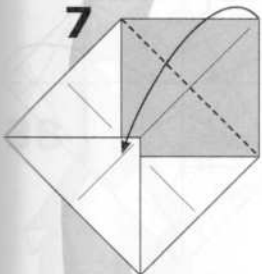

縁を合わせて折る

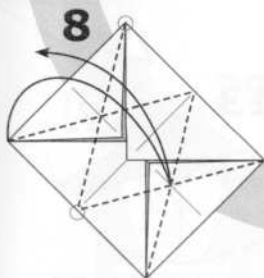

カドを折り筋の交点に
合わせて折り筋を付ける
(残りの3ヶ所も同様)

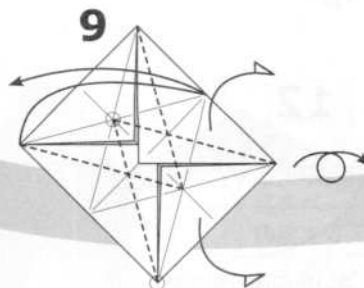

折り筋を付けたら
全て開く

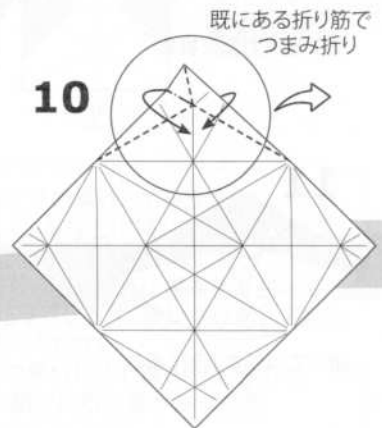

既にある折り筋で
つまみ折り

22

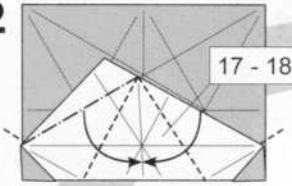

「17」と同様に折りながら
左右のカドを引き寄せ折り

23

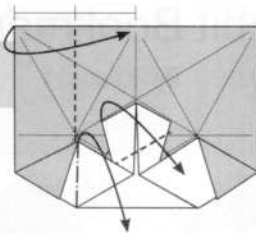

「18」の折りをを行いながら
縁を中心線に合わせて折る

24

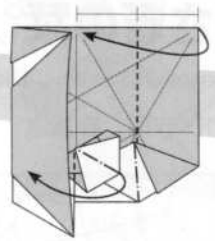

「19」の折りをを行いながら
縁を中心線に合わせて折る

21

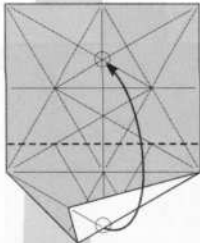

○印を合わせて折る



16

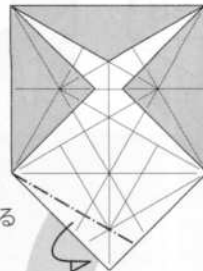

既にある
折り筋で
後ろに折る

15

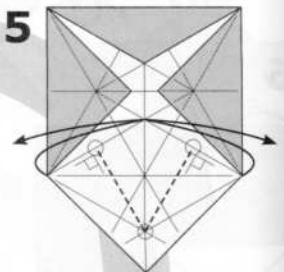

カドを折り筋の交点に
合わせて折り筋を付ける

20

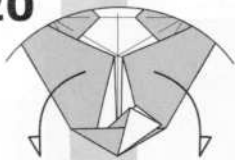

折り筋を付けたら
「17」の状態まで開く

17

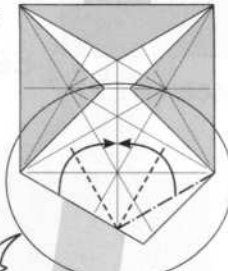

「15」の折り筋で谷折り
して浮いてくる部分を次
の図のように平らに折る

14

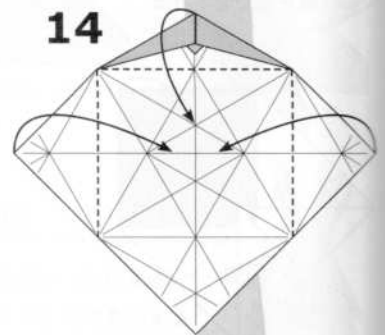

既にある折り筋で折る

19

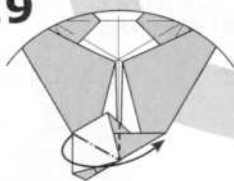

(つまみ折りで)
カドを反対側に折る

18



後ろにある○印のカド
を基準にしてカドを
縁に合わせて折る

11

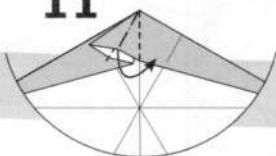

開いてつぶすように折る

12

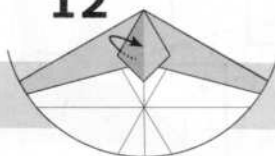

濃い色の部分を沈めて下
にある紙を手前に引き出す

13

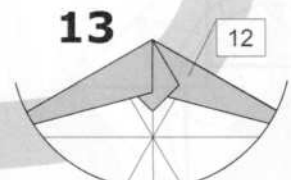

反対側も「12」と同様に折る

12

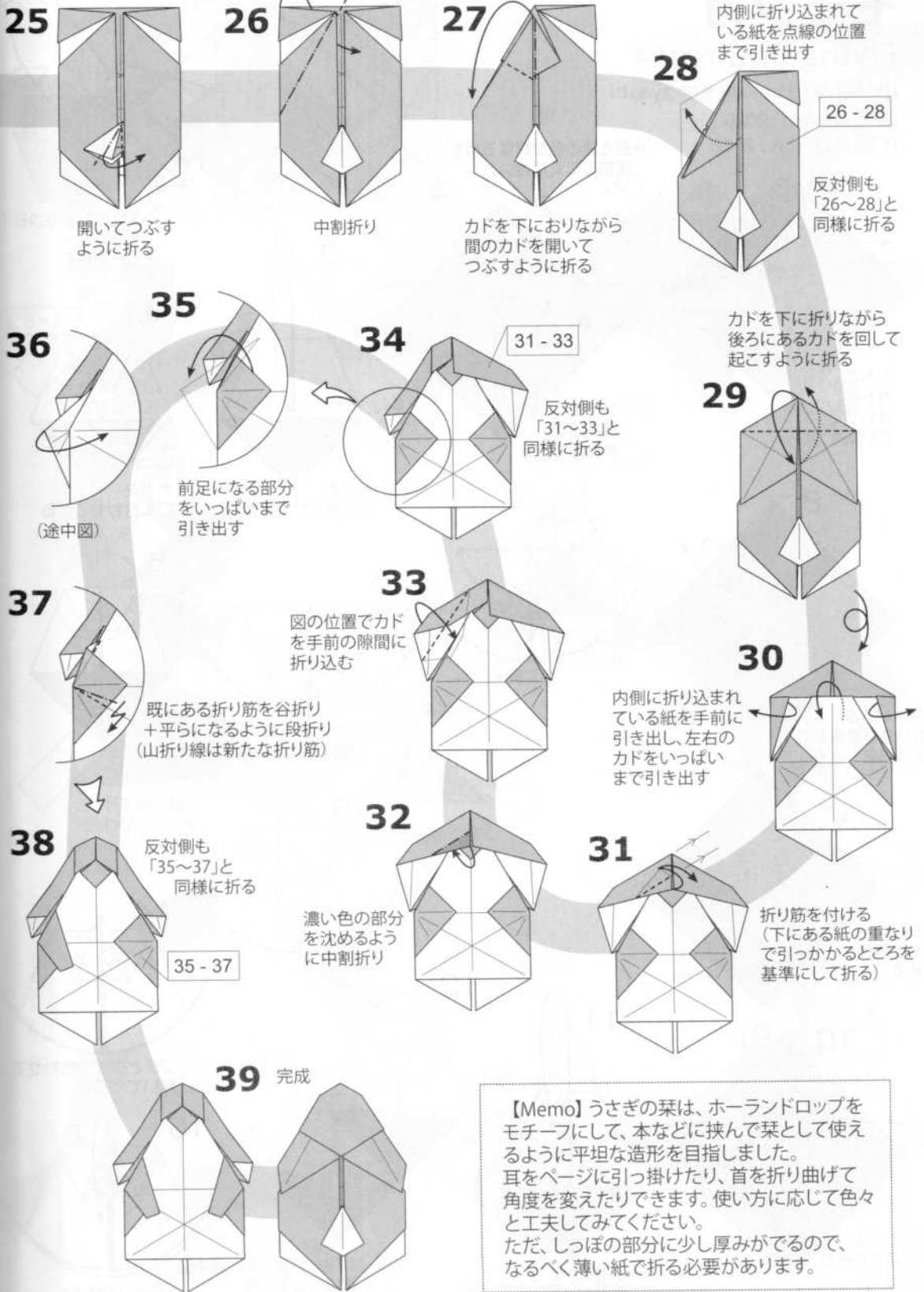

【Memo】うさぎの葉は、ホーランドロップをモチーフにして、本などに挟んで葉として使えるように平坦な造形を目指しました。耳をページに引っ掛けたり、首を折り曲げて角度を変えたりできます。使い方に応じて色々と工夫してみてください。ただ、しっぽの部分に少し厚みがでるので、なるべく薄い紙で折る必要があります。

モモンガ

Flying Squirrel

小林弘明 Hiroaki Kobayashi

創作 Created : 2020

作図 Diagrams : 2022

※表と裏の色が異なる紙を使用してください。

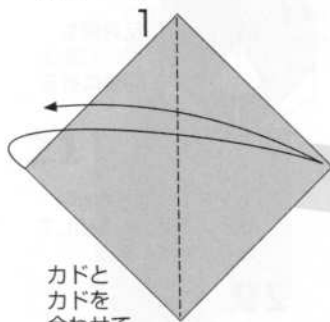
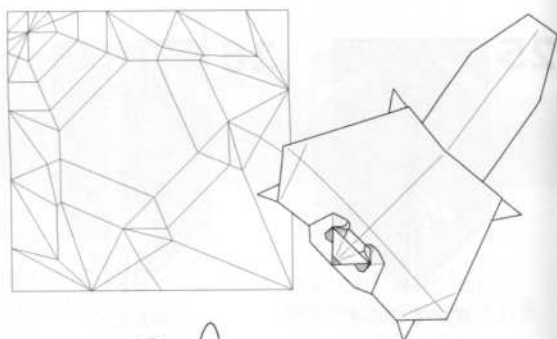

1
カドとカドを
合わせて
折り筋をつける

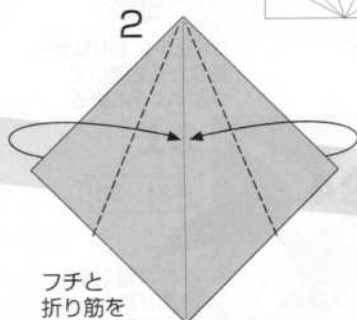

2
フチと
折り筋を
合わせて折る

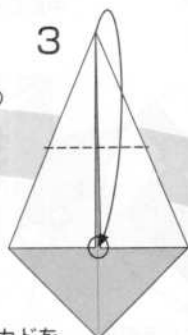

3
カドを
○に合わせて折る

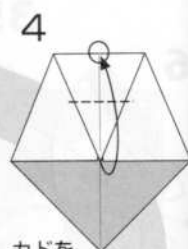

4
カドを
○に合わせて折る

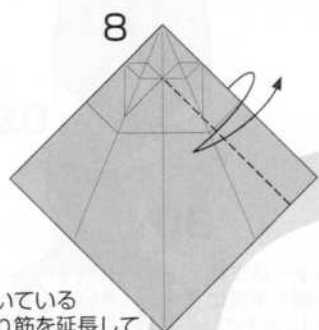

8
ついている
折り筋を延長して
折り筋をつける

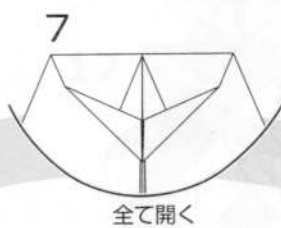

7
全て開く

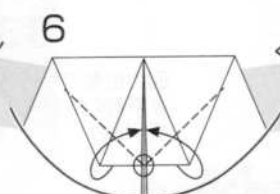

6
フチと折り筋
に合わせて折る

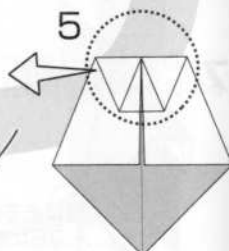

5
カドを
○に合わせて折る

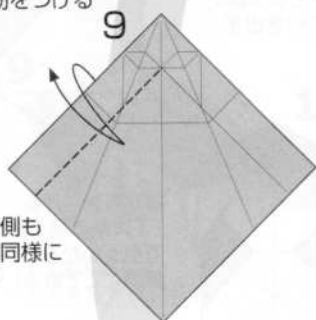

9
反対側も
8と同様に
折る

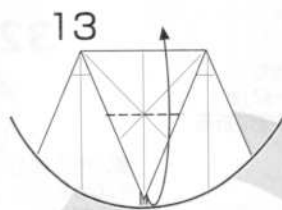

13

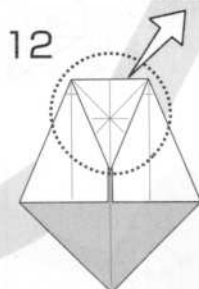

12



14

フチとフチを
合わせて
開いてつぶす

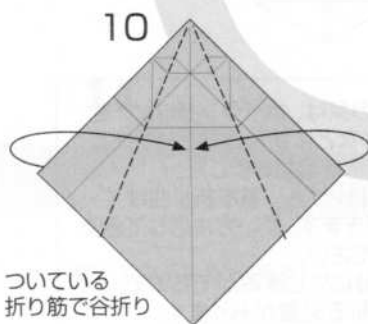

10
ついている
折り筋で谷折り

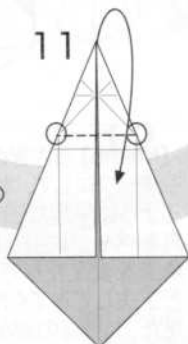

11

○同士を
つなく線で折る

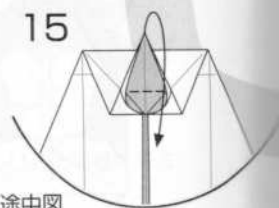

15

途中図

©Hiroaki Kobayashi

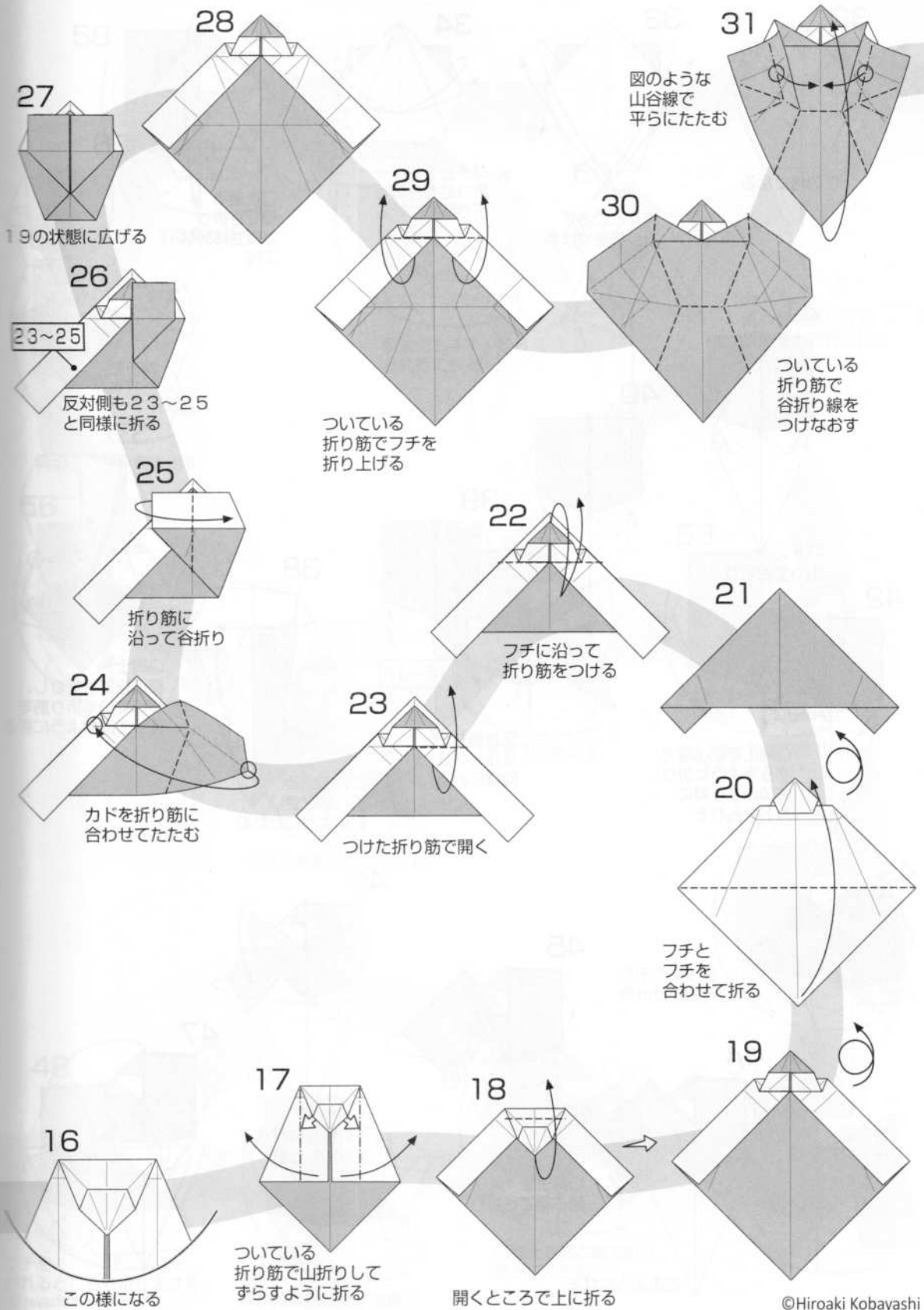

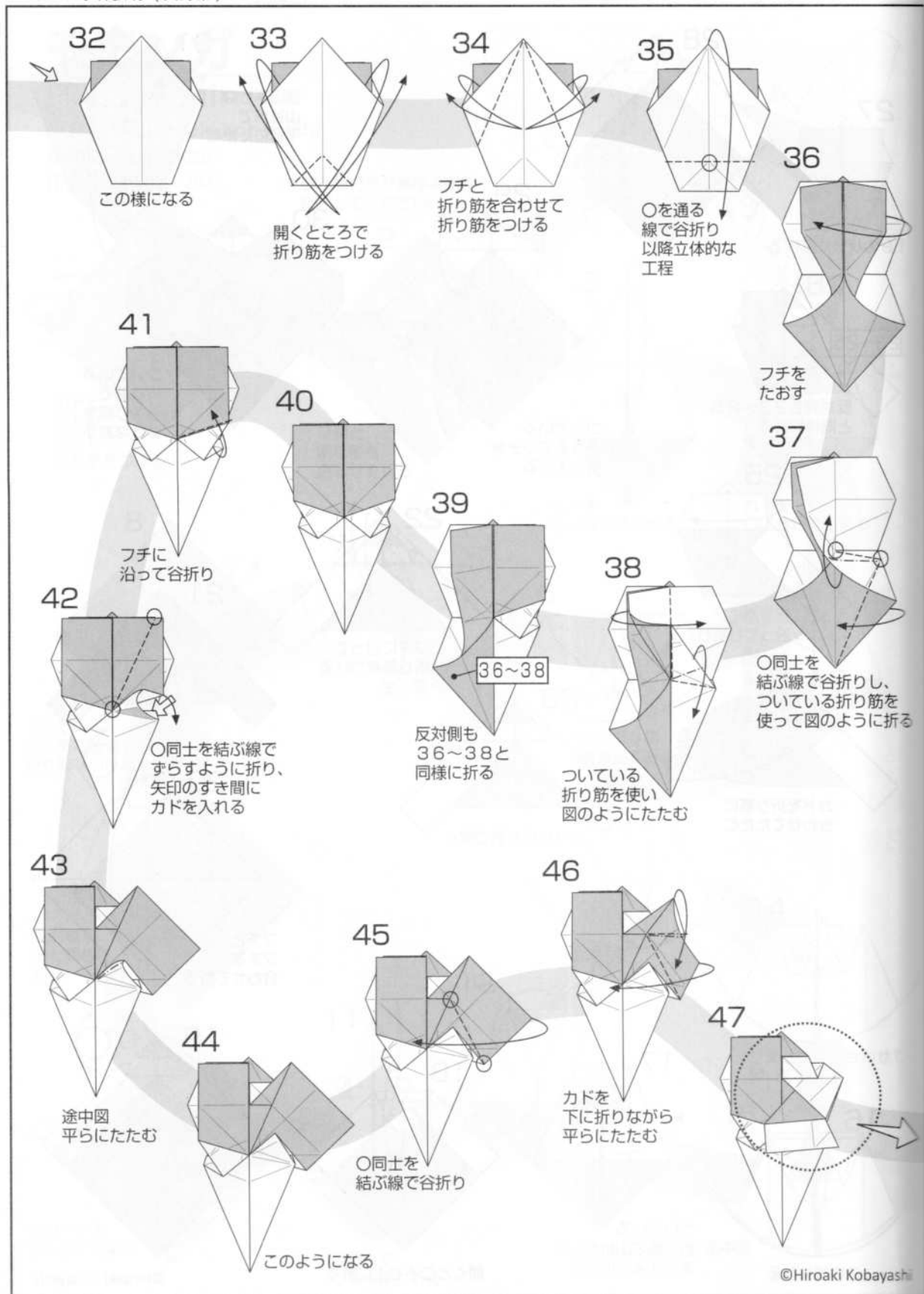

©Hiroaki Kobayashi

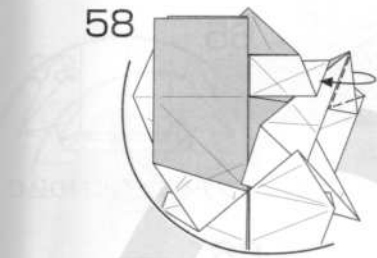

58

引き寄せ折り

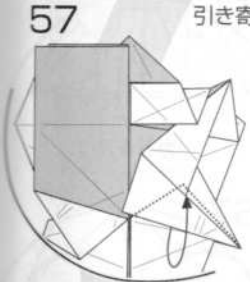

57

奥のフチを手前に出す

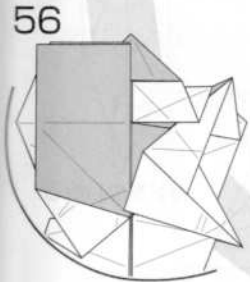

56

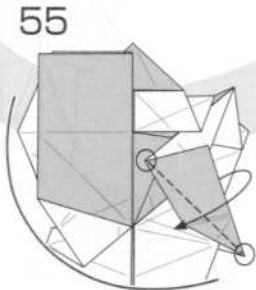

55

○同士を結ぶ線で谷折り



54

フチを下にたおす

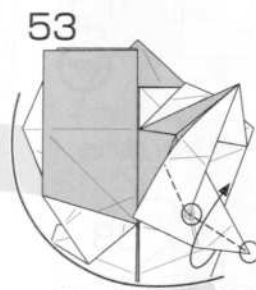

53

○同士を結ぶ線で折り
平らにたたむ

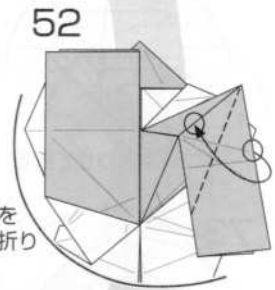

52

フチとフチを
合わせて谷折り

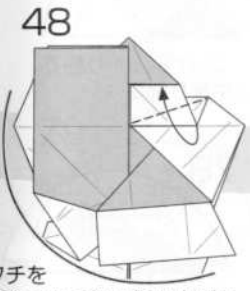

48

フチを
折れるところで折り上げる

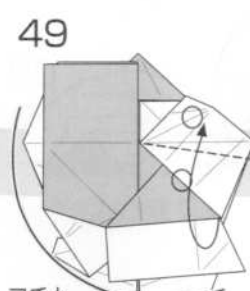

49

フチと
折り筋を合わせて谷折り

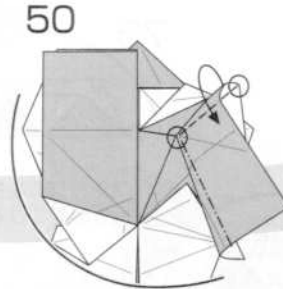

50

○同士を結ぶ線で折り
平らにたたむ

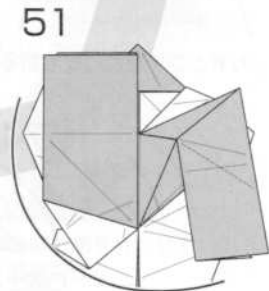

51

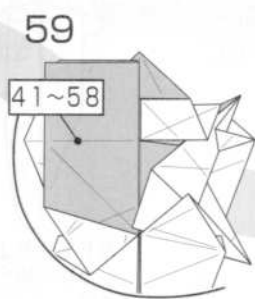

59

41~58

反対側も41~58
と同様に折る



60



61

カドと
折り筋を合わせて
折り筋と平行に折る

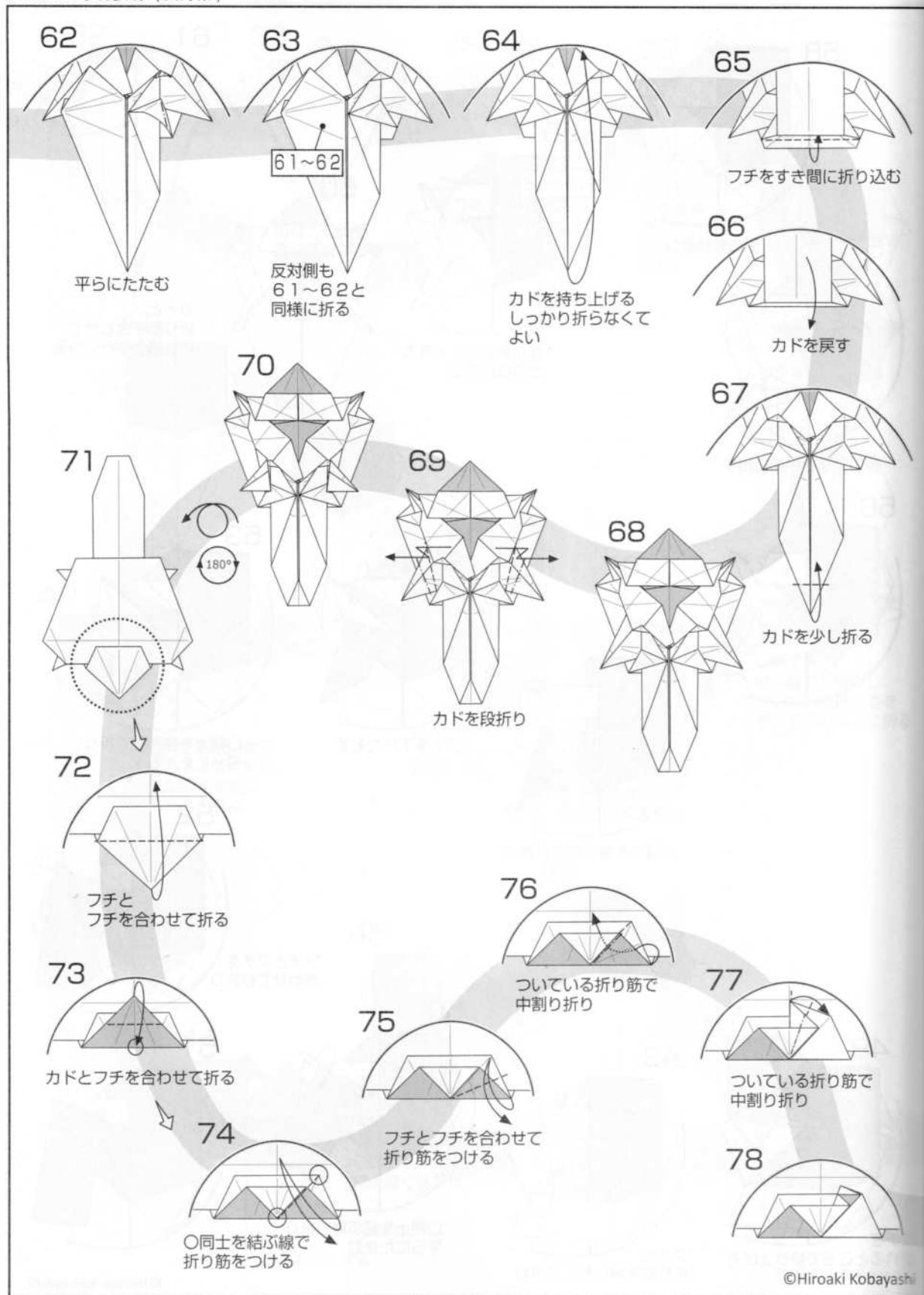

©Hiroaki Kobayashi

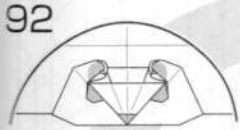

92 頭部完成

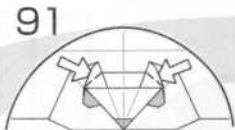

91 耳を広げる

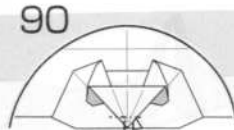

90 カドを少し折る

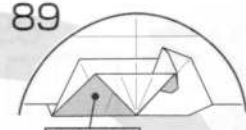

74~88

反対側も74~88と同様に折る

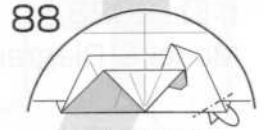

88 カドを折り込む



87 カドを少し折り込む

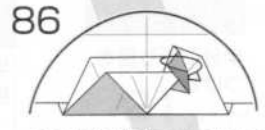

86 色の濃い部分をかぶせ折り



85

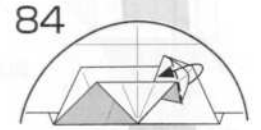

84 平らにたたむ

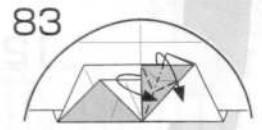

83

つけた折り筋で中割り折り平らにはならない



79 矢印のすき間でフチに沿って折り筋をつける

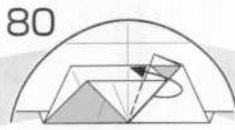

80 フチを開く

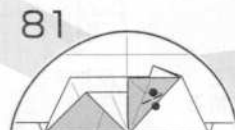

81 フチと折り筋を合わせて折り筋をつける

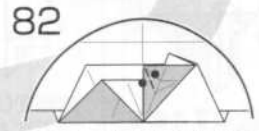

82 フチと折り筋を合わせて折り筋をつける

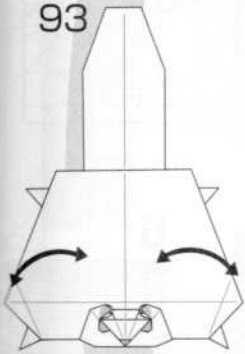
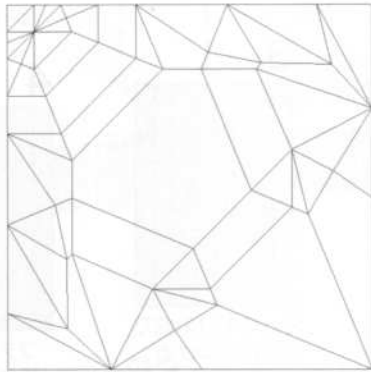

93 身体に丸みをつける

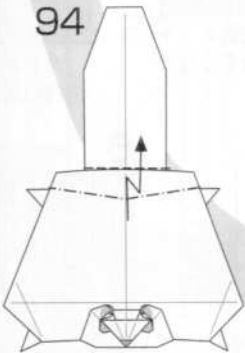

94 段折り

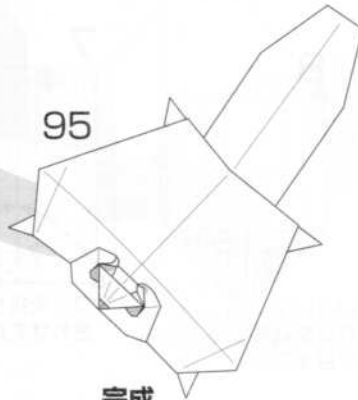

95 完成

キツネ Fox

創作 / 作図: 尾川 知

創作: 2021.

作図: 2023.10.

Model & Diagrams by Tomo Ogawa

※縦と横の比率が
 $\sqrt{2}:1$ の紙を使用します。

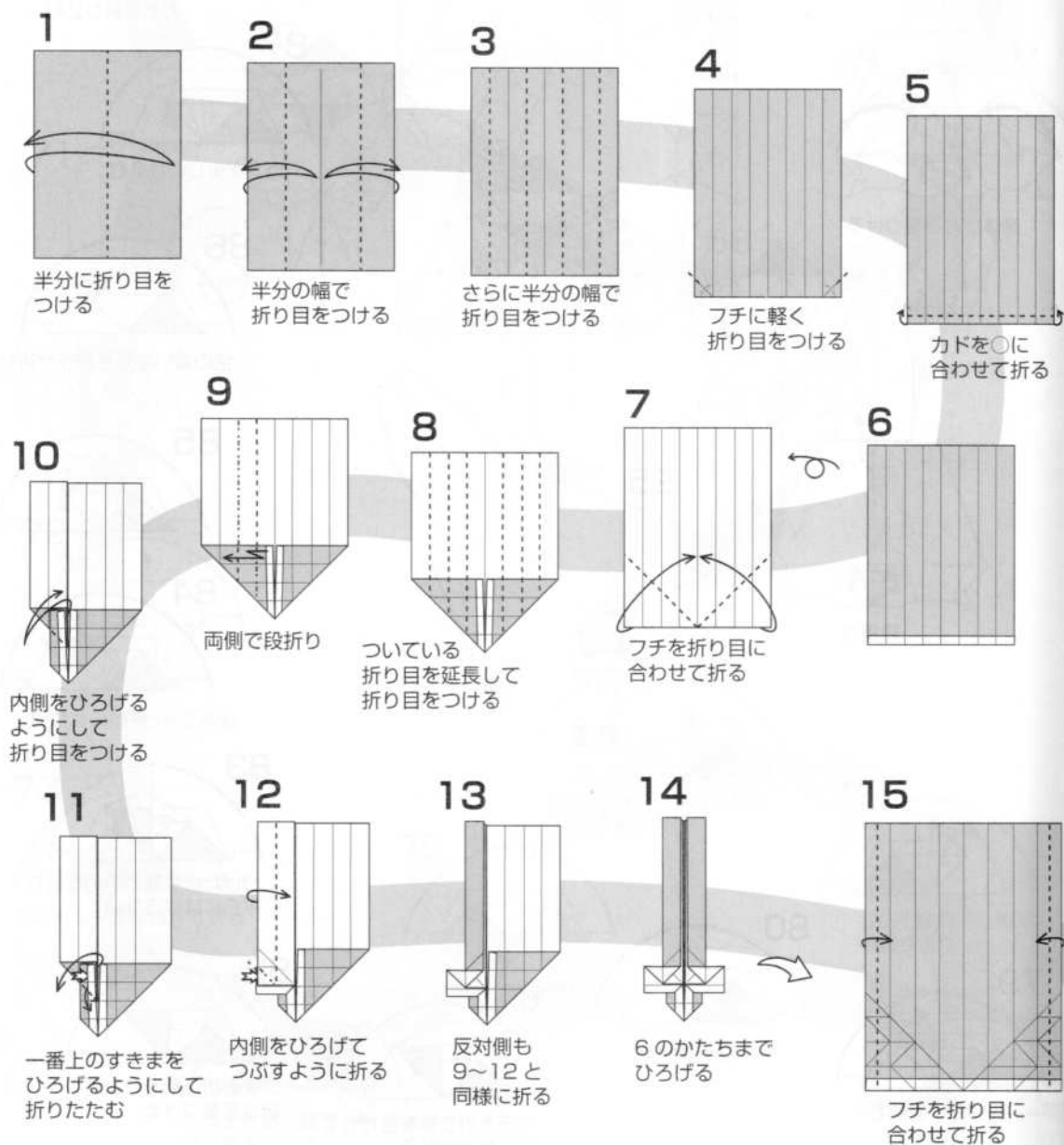
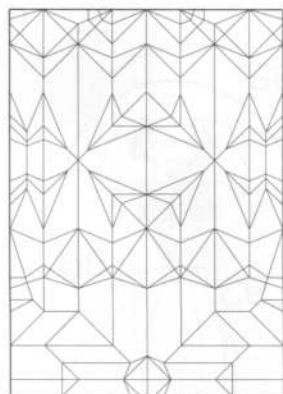
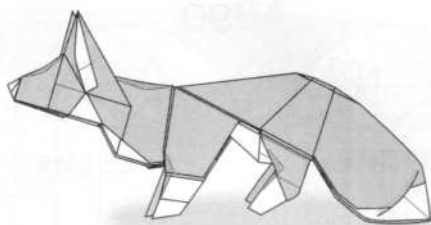

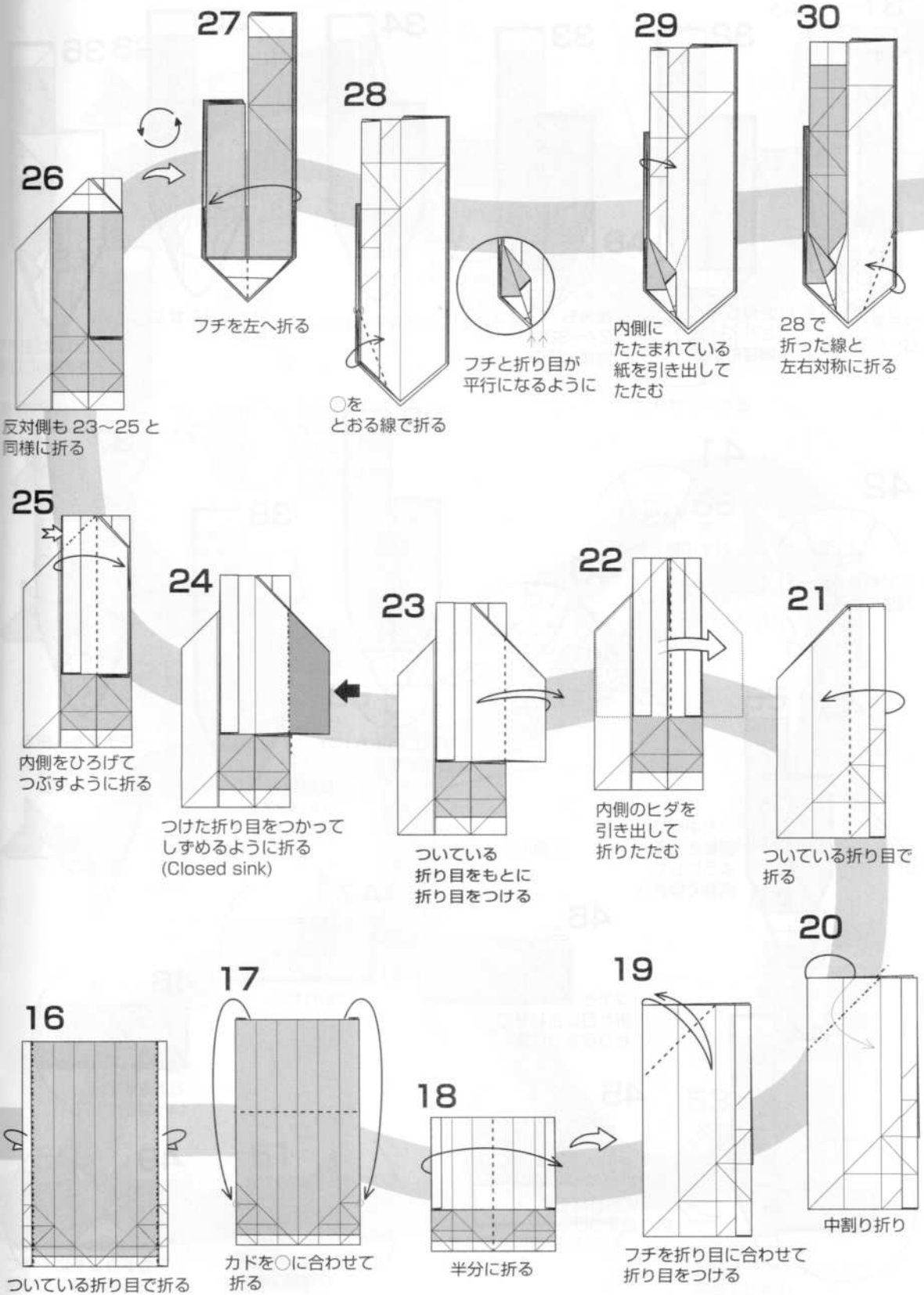

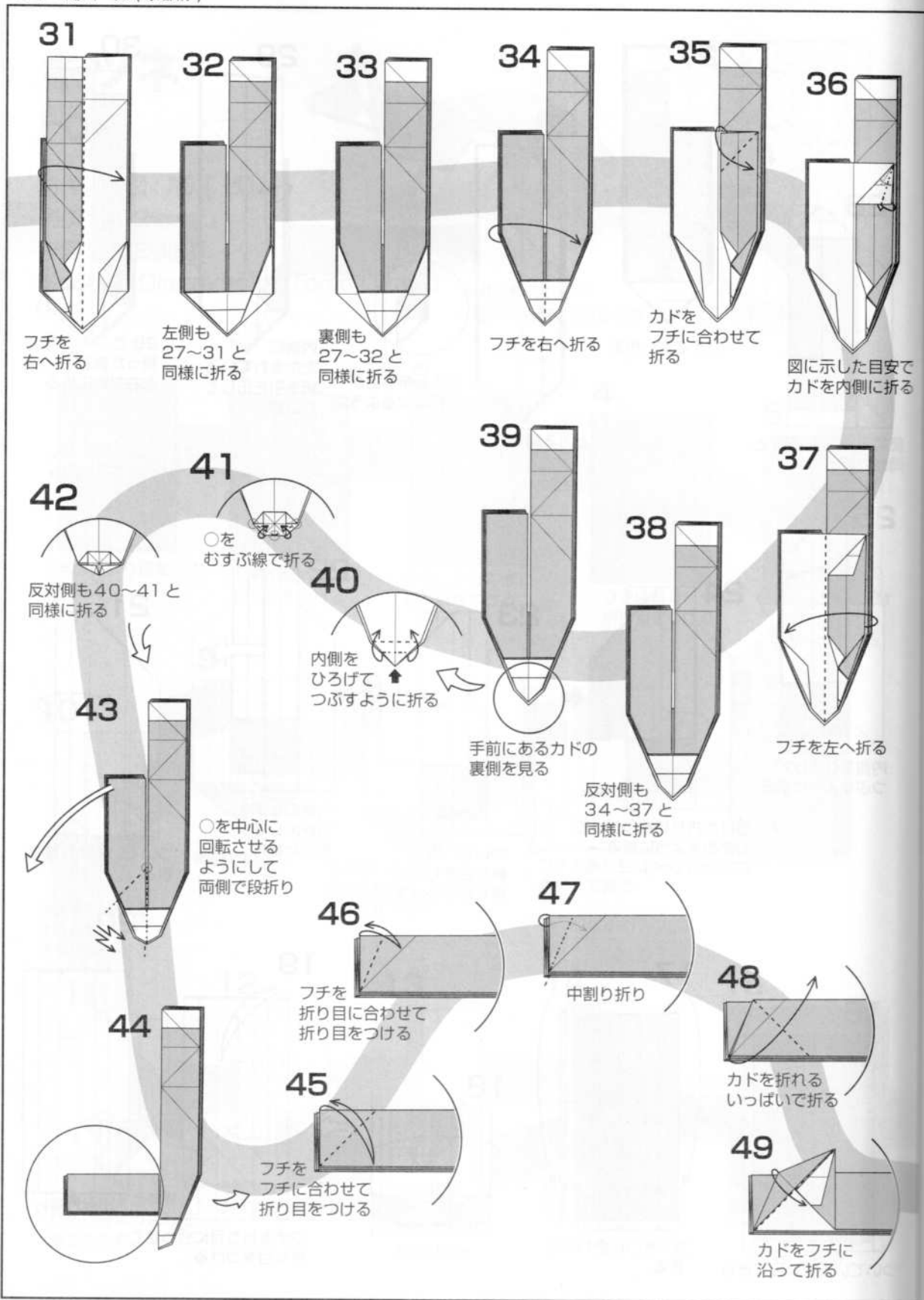

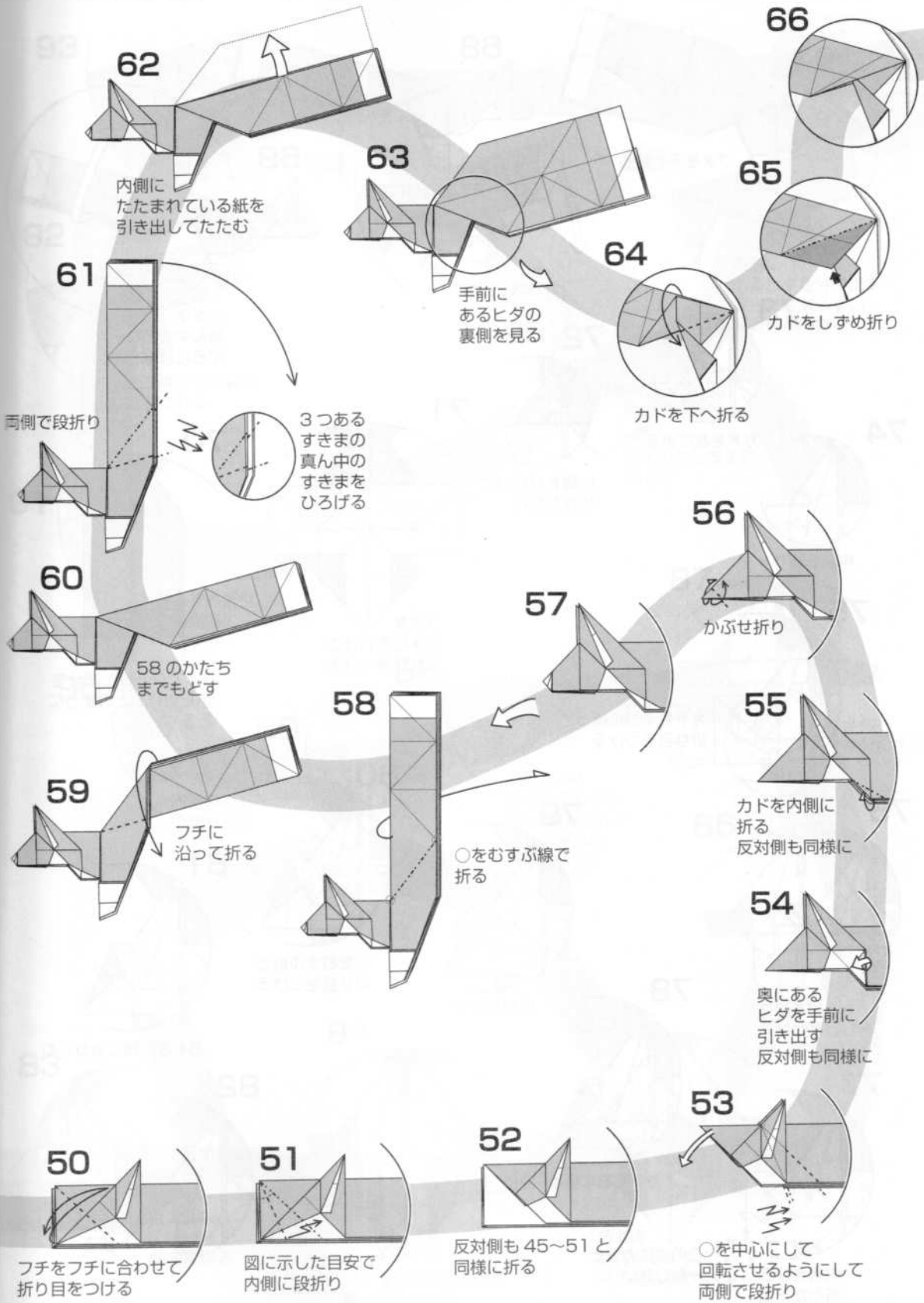

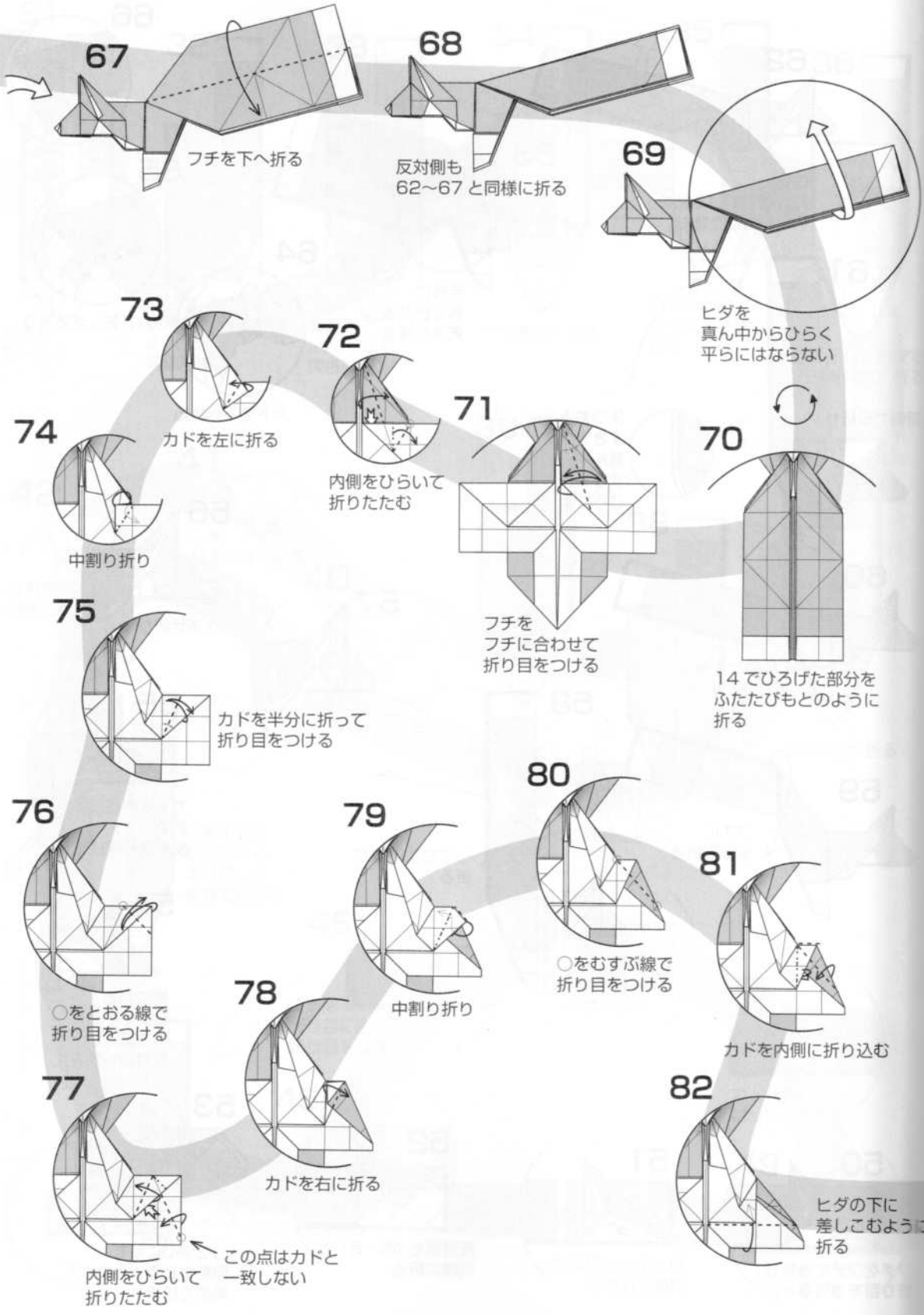

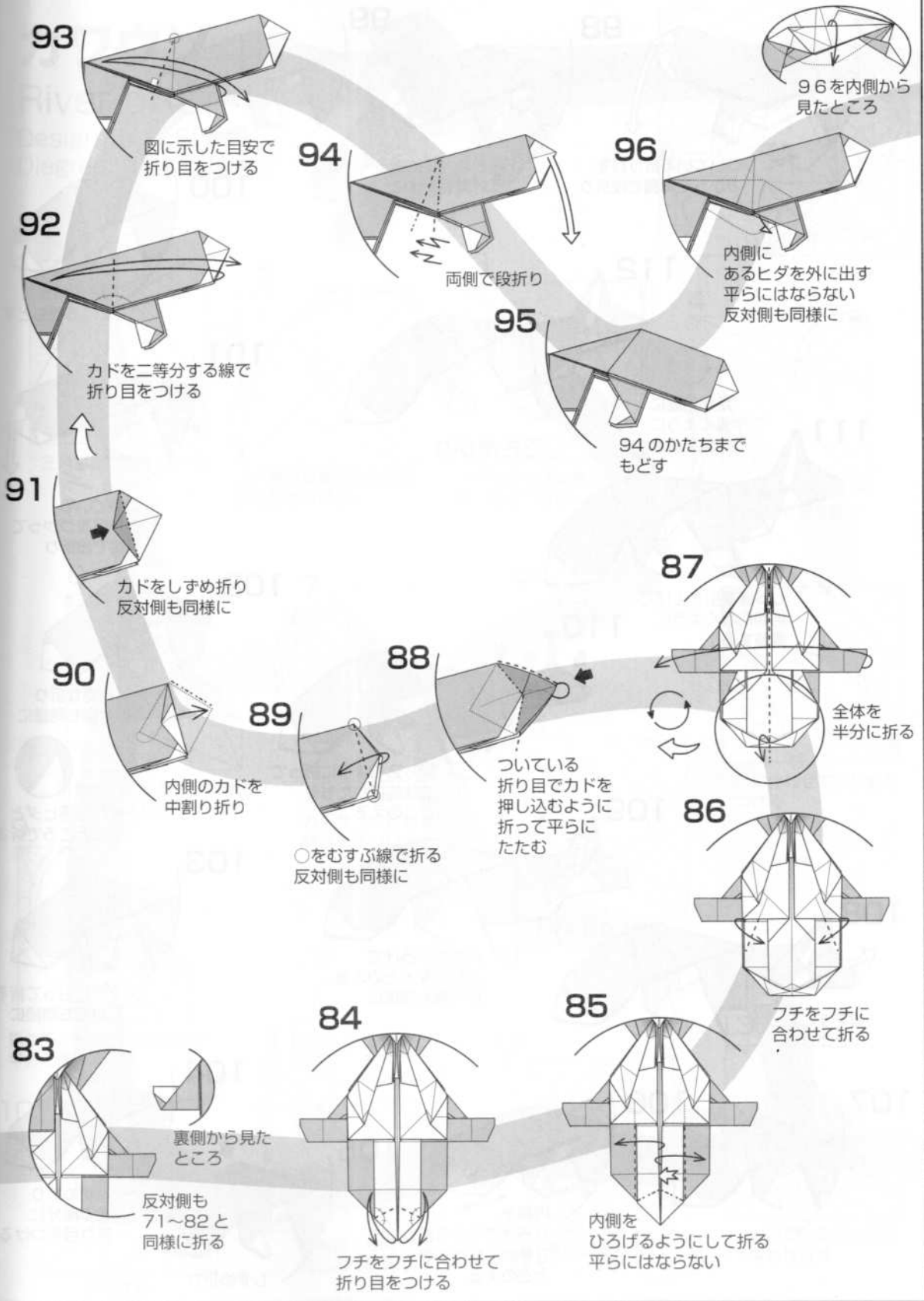

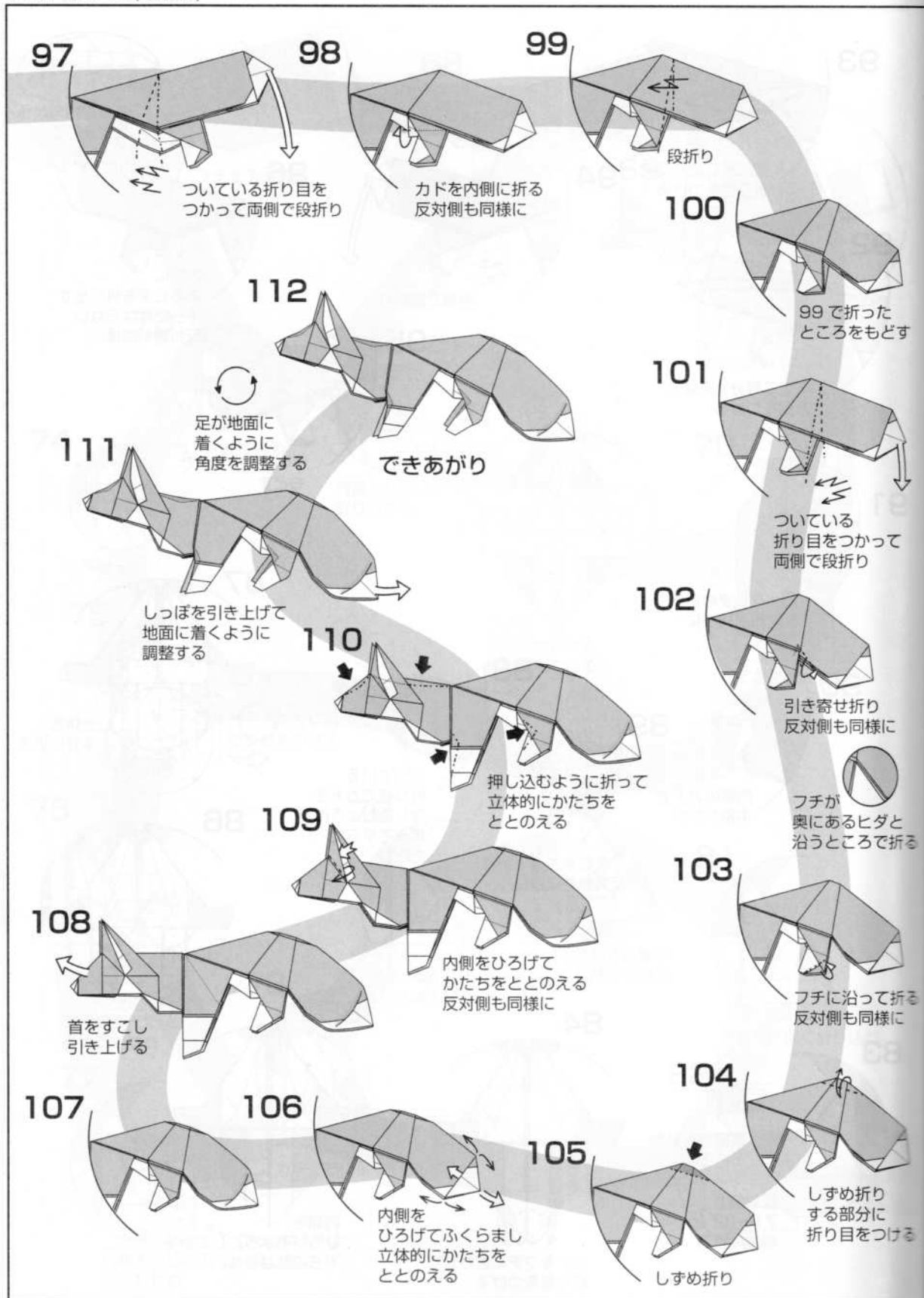

カワウソ

River otter

Design: Taiga Shinto

Diagram: Taiga Shinto

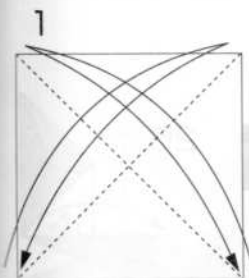
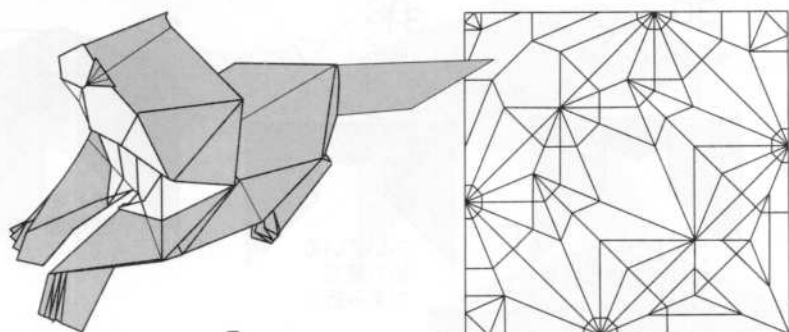

1 三角に折り筋をつける

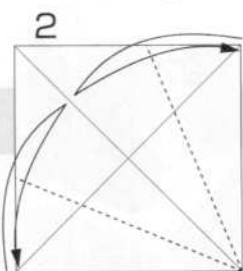

2 フチを折り筋に合わせて折り筋をつける

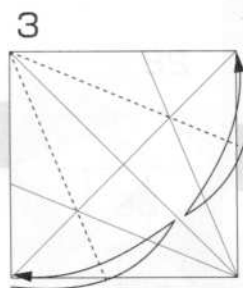

3 フチを折り筋に合わせて折り筋をつける

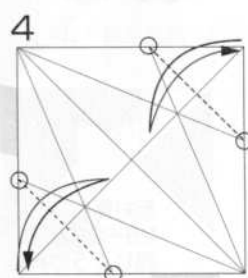

4 ○に合わせて折り筋をつける

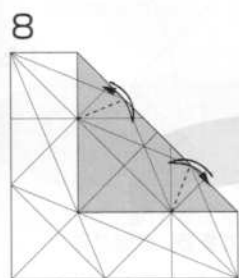

8 折り筋と折り筋を合わせて半分の角度で折る

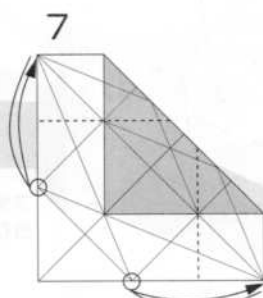

7 カドを○に合わせて折り筋をつける

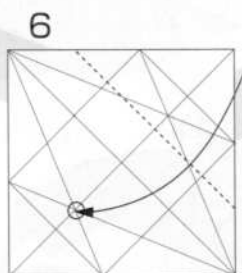

6 カドを○に合わせて折る

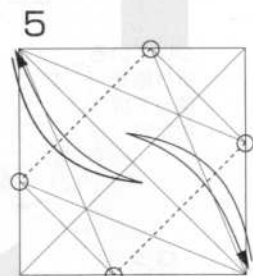

5 ○に合わせて折り筋をつける

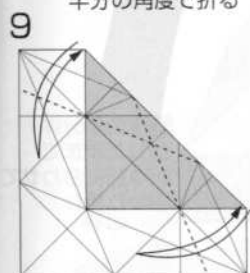

9 折り筋と折り筋を合わせて半分の角度で折る

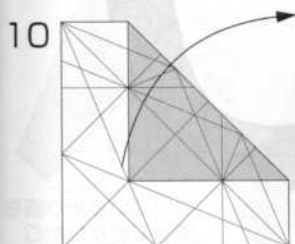

10 ひろげる

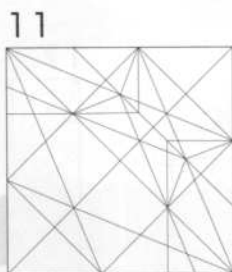

11 反対側も6-10と同じように折る

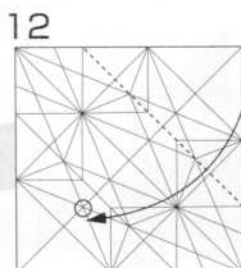

12 カドを○に合わせて折る

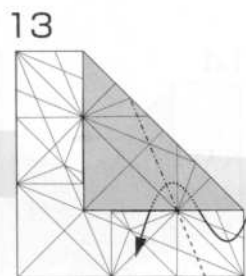

13 ついている折り筋で中わり折り

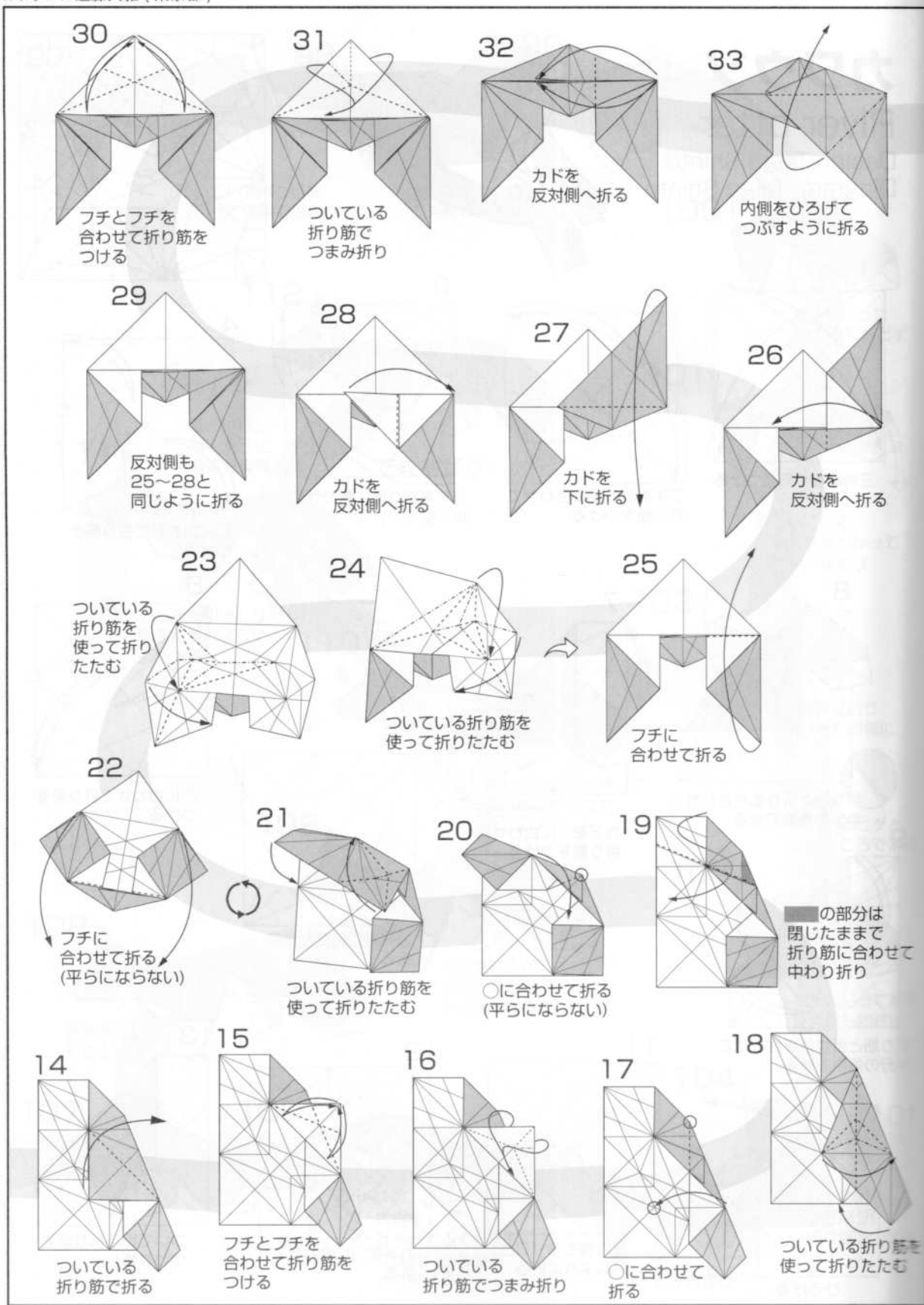

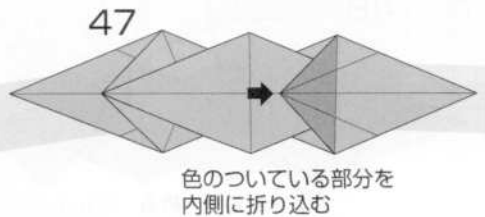
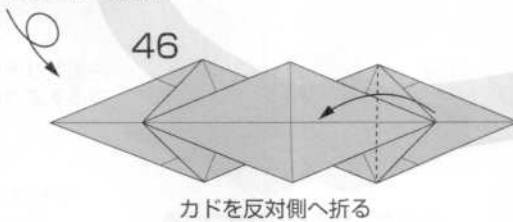
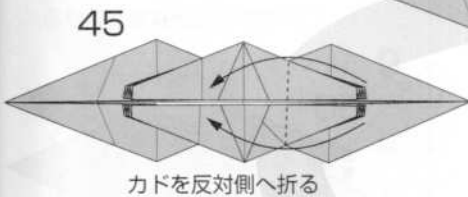
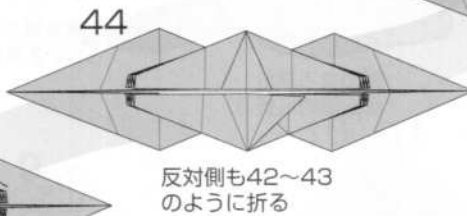
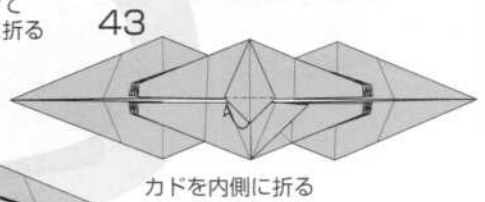
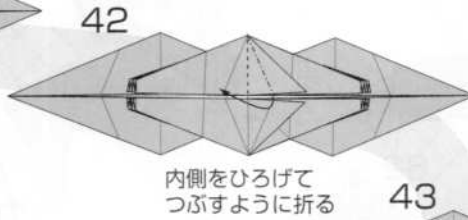
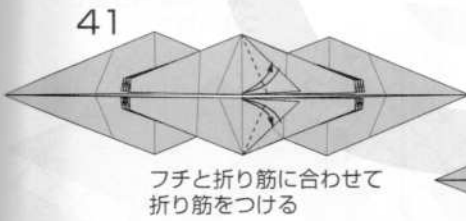
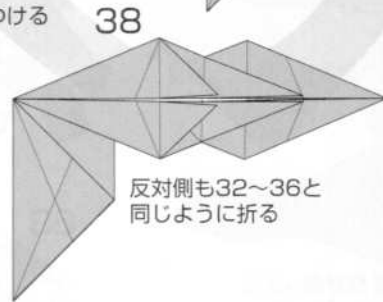
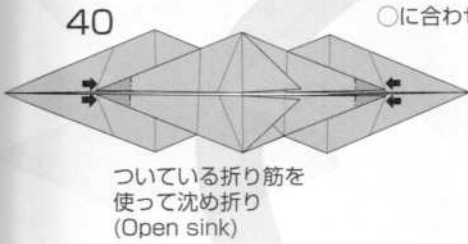
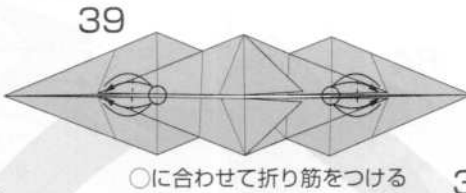
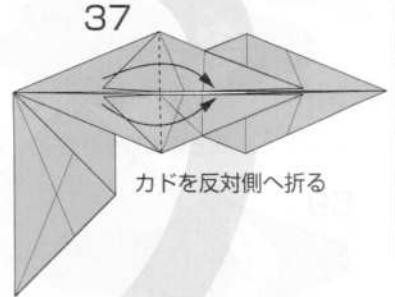
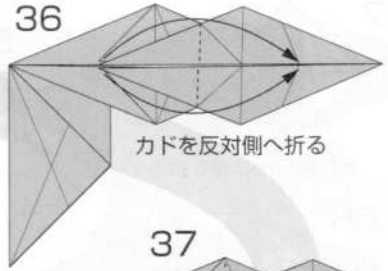
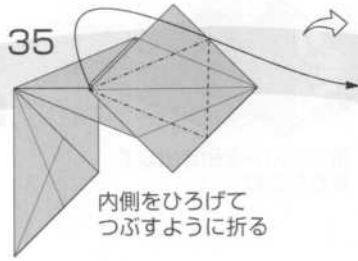

57

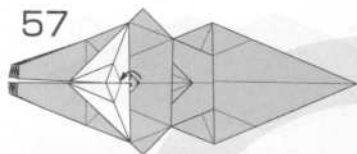

折り筋に合わせて折る

56

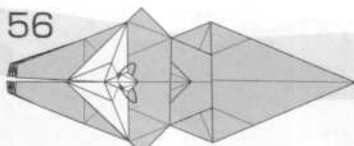

後ろのカドを引き出して
折りたたむ

55

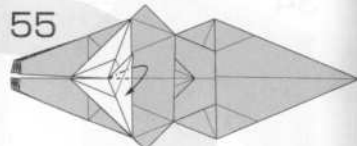

内側をひろげて
つぶすように折る

58

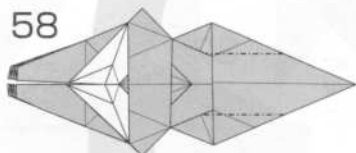

後ろ側に折り込む

54

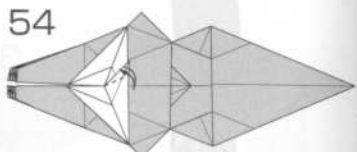

フチと折り筋を合わせて
折り筋をつける

59

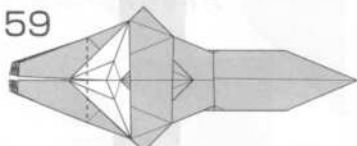

カドを反対側へ折る

64



できあがり

53

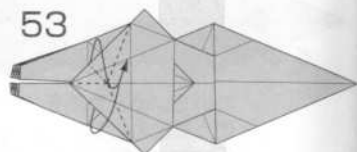

ついている折り筋で
つまみ折り

60

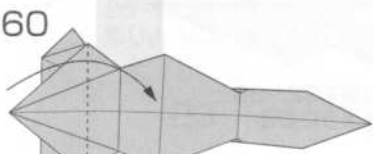

カドを反対側へ折る

63

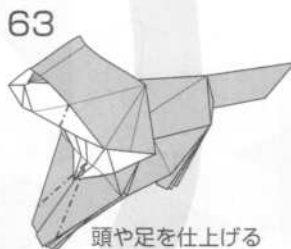

頭や足を仕上げる

52

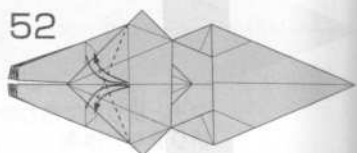

フチと折り筋を合わせて
折り筋をつける

61

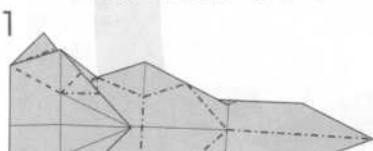

全体を立体的にする

62

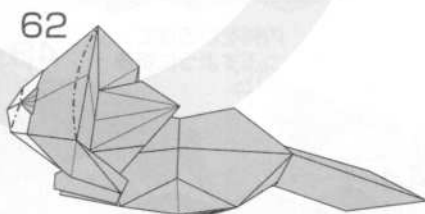

頭の後ろ部分
を曲線的に折る

51

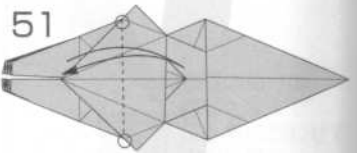

○に合わせて折り筋をつける

48

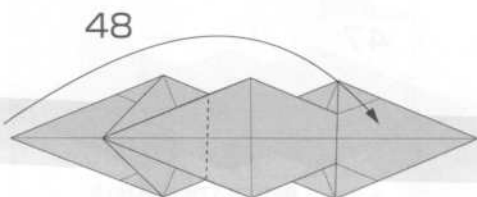

カドを反対側へ折る

49

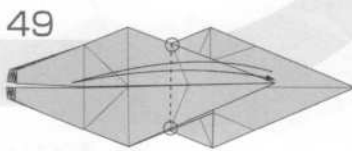

○に合わせて折り筋をつける

50

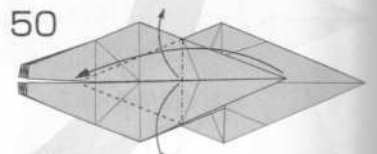

内側をひろげて
つぶすように折る

カワウソ Otter

神谷 哲史
Model & Diagrams
by Satoshi Kamiya
作 2023/10/17

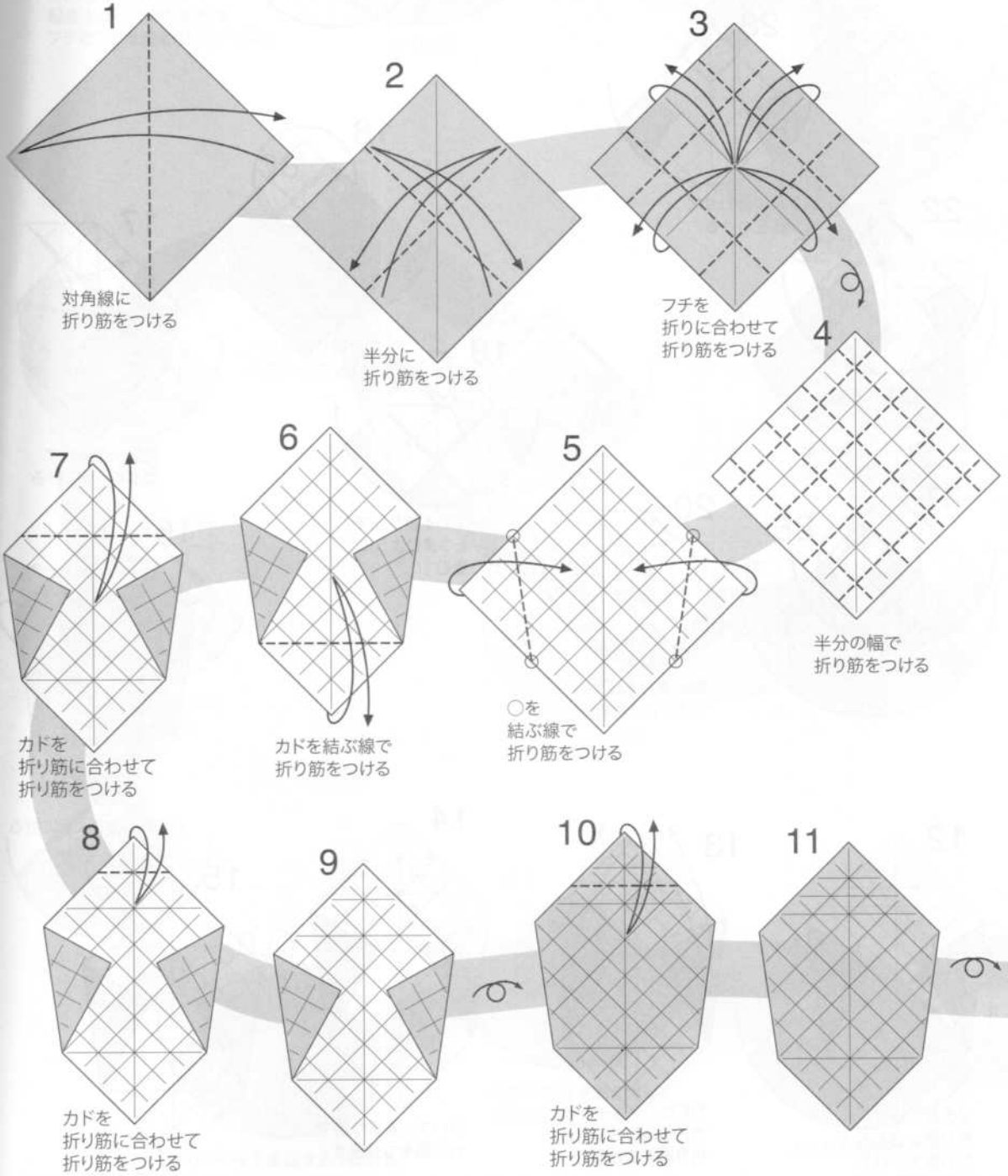
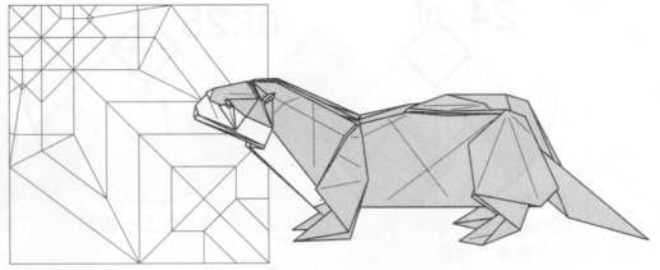

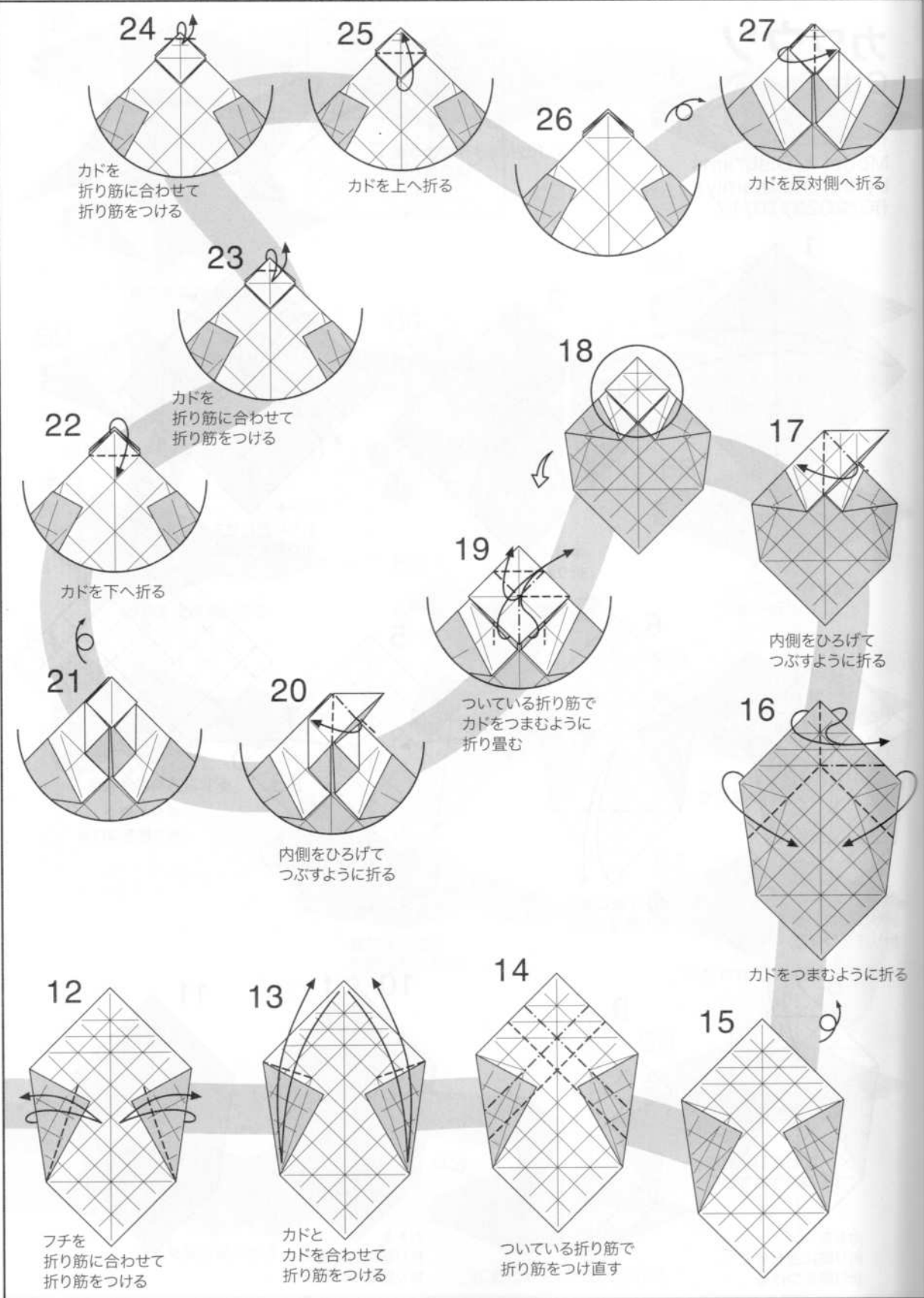

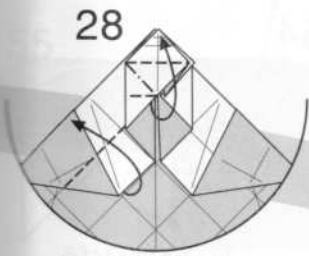

28
カドとカドを合わせて
起き上がった部分を
フチとフチを合わせて折り畳む

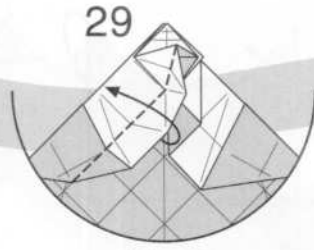

29
途中の図

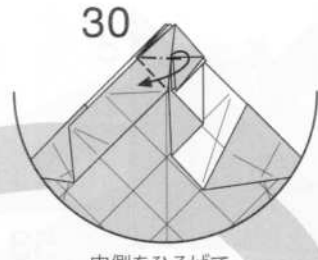

30
内側をひろげて
つぶすように折る

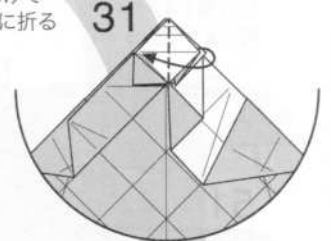

31
カドを反対側へ折る

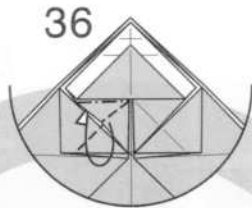

36
つけた折り筋を使って
内側へ折り込む

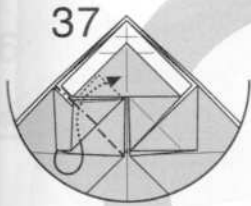

37
中割り折り



35
カドとカドを合わせて
折り筋をつける

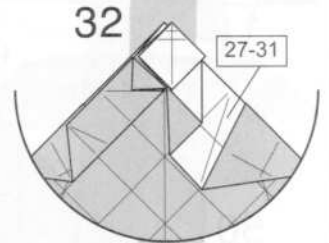

32
反対側も27-31と
同じように折る

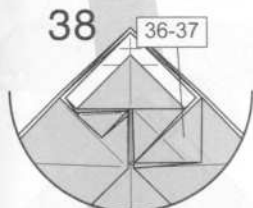

38
反対側も36-37と
同じように折る

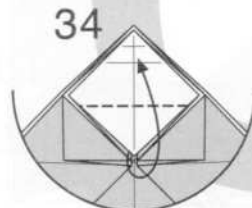

34
カドを上へ折る

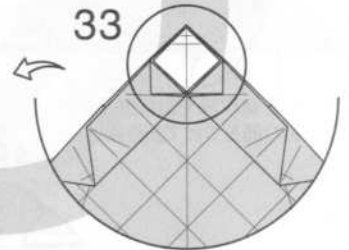

39
カドの先を裏返すように折る

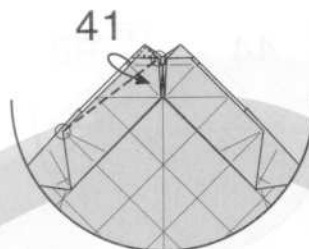

41
内側の部分を引き出して
○を結ぶ線で折る

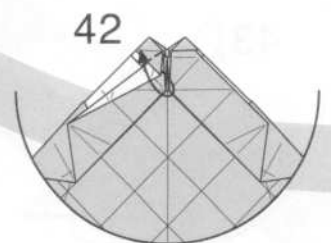

42
カドを反対側へ折る

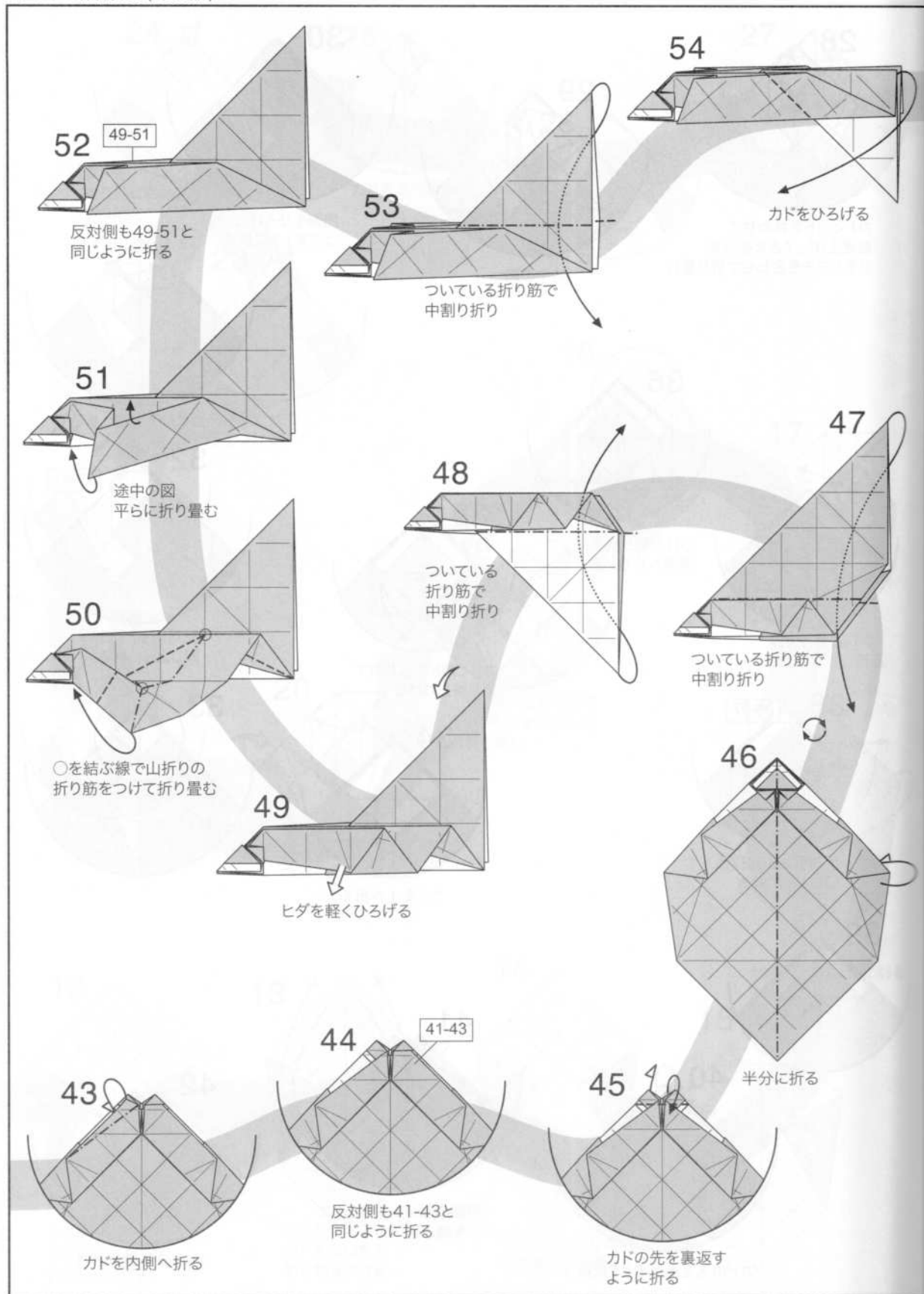

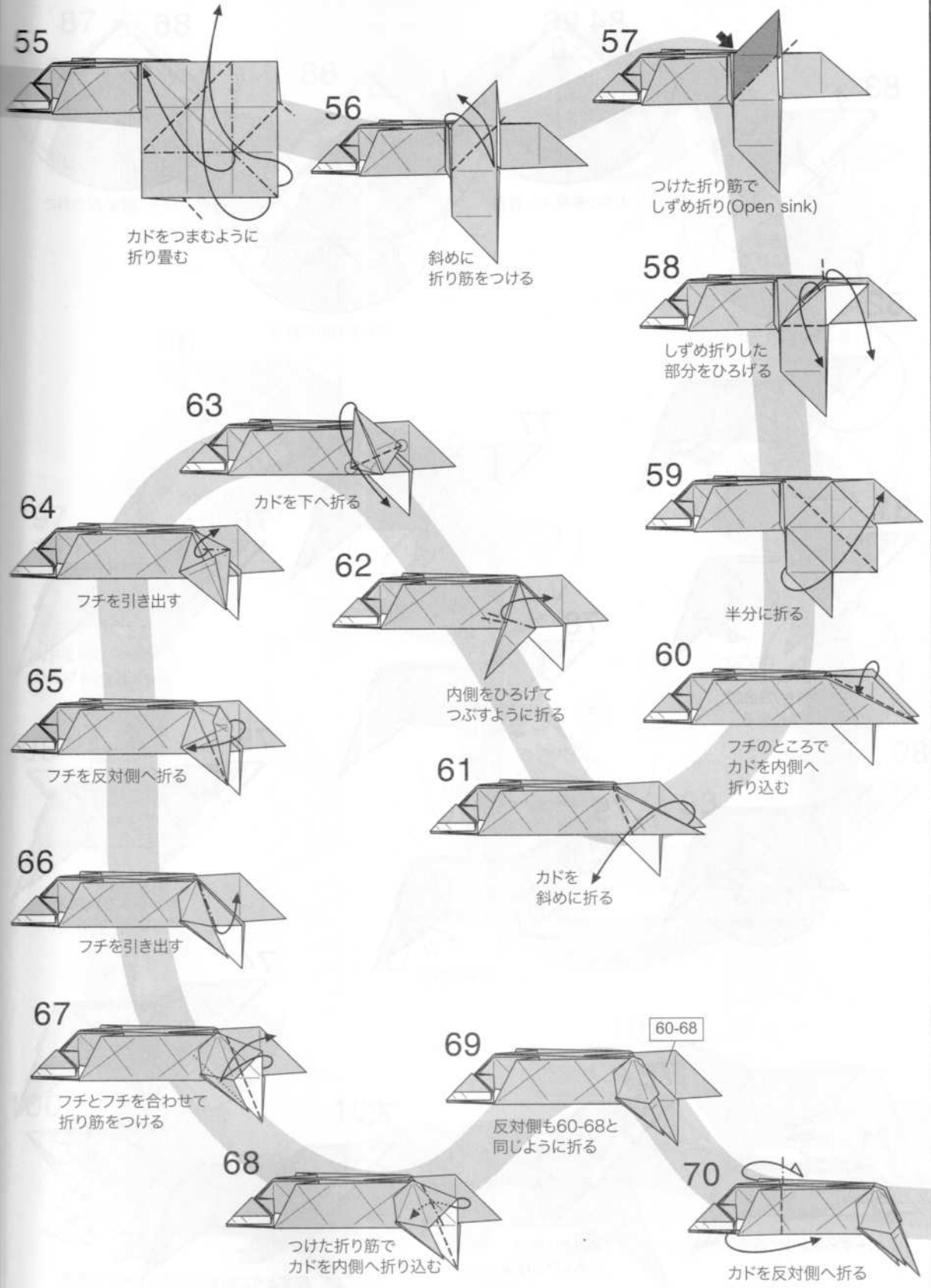

55
カドをつまむように
折り畳む

56
斜めに
折り筋をつける

57
つけた折り筋で
しずめ折り(Open sink)

58
しずめ折りした
部分をひろげる

63
カドを下へ折る

59
半分に折る

64
フチを引き出す

62
内側をひろげて
つぶすように折る

60
フチのところ
カドを内側へ
折り込む

65
フチを反対側へ折る

61
カドを
斜めに折る

66
フチを引き出す

67
フチとフチを合わせて
折り筋をつける

69
反対側も60-68と
同じように折る

68
つけた折り筋で
カドを内側へ折り込む

70
カドを反対側へ折る

60-68

