

67



아래로 접어  
내려주세요.

68



뒤집어 주세요.

71

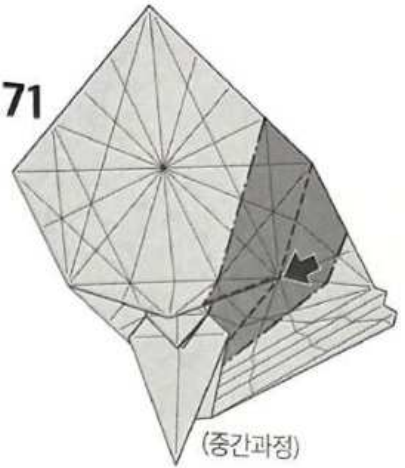

(중간과정)

66



아래로 접어  
내려주세요.

69

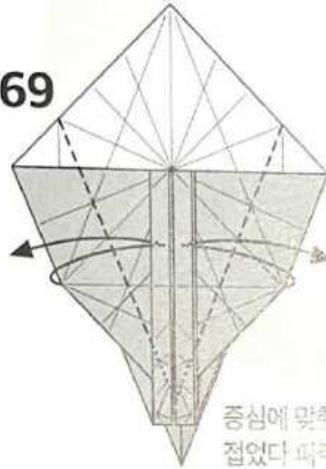

중심에 맞춰  
접었다 펴주세요.

70



함몰접기  
(Open sink)

65

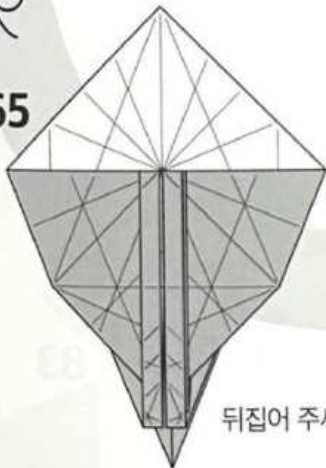

뒤집어 주세요.

64

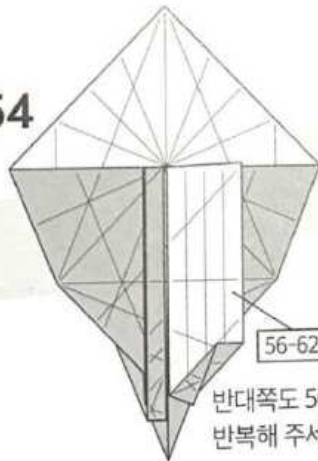

반대쪽도 56-62를  
반복해 주세요.

63

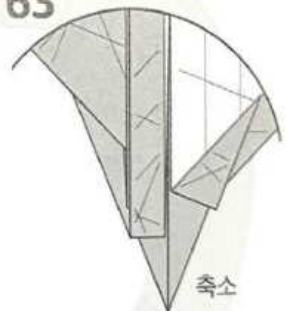

축소

60



표시된 선을 따라  
펼쳐 눌러 접으면서  
한 겹을 옆으로 넘기세요.

61

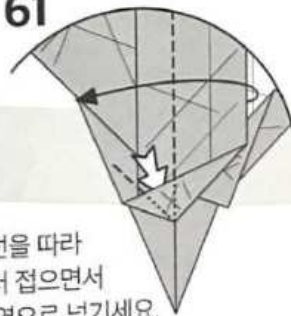

표시된 선을 따라  
펼쳐 눌러 접으면서  
한 겹을 옆으로 넘기세요.

62

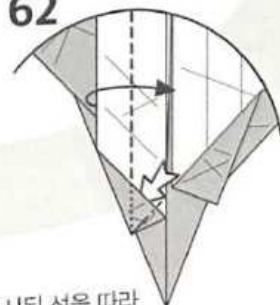

표시된 선을 따라  
반으로 펼쳐 눌러 접어주세요.

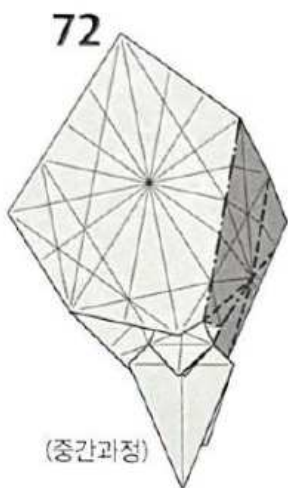

(중간과정)

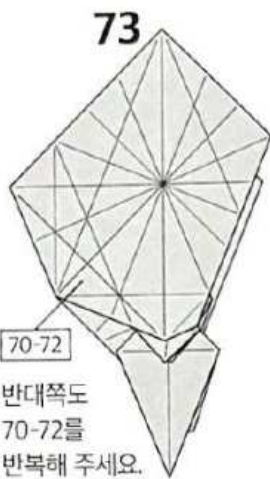

70-72  
반대쪽도  
70-72를  
반복해 주세요.



뒤집어 주세요.

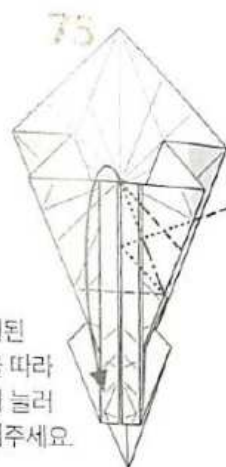

표시된  
선을 따라  
펼쳐 눌러  
접어주세요.

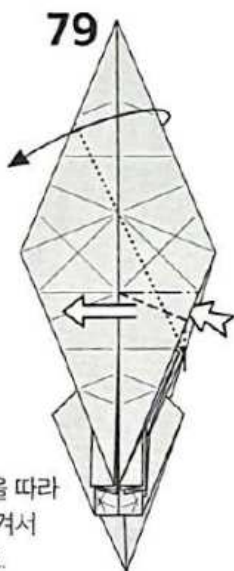

표시된 선을 따라  
한 겹을 당겨서  
펼쳐주세요.

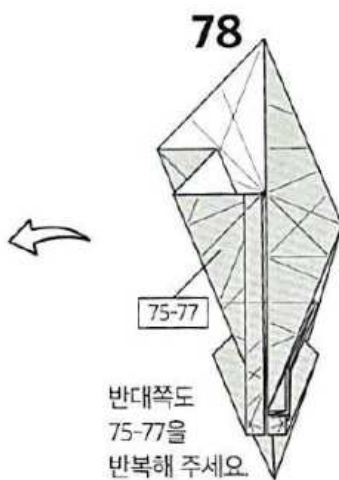

75-77  
반대쪽도  
75-77을  
반복해 주세요.

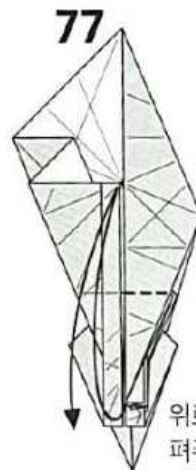

위로 접었다  
펴주세요.

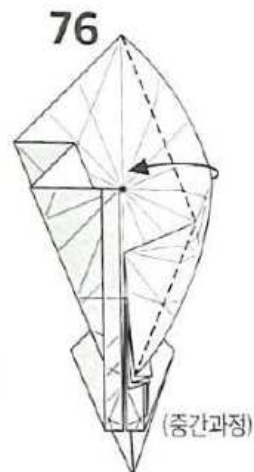

(중간과정)

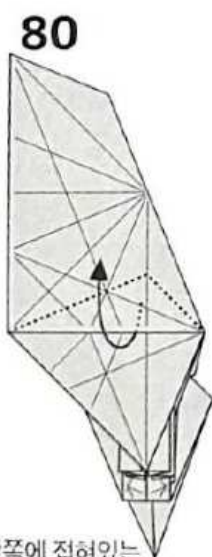

안쪽에 접혀있는  
각을 밖으로 빼주세요.

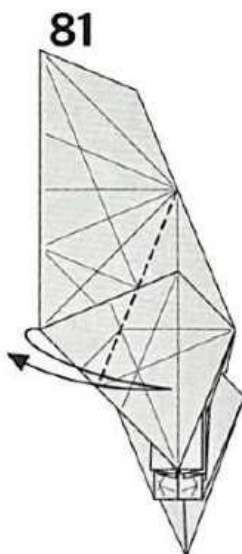

표시된 선을 따라  
접었다 펴주세요.

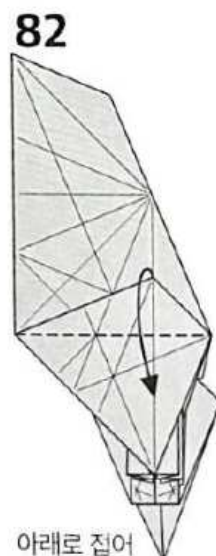

아래로 접어  
내려주세요.



표시된  
선을 따라  
함몰접기  
(Open sink)



92

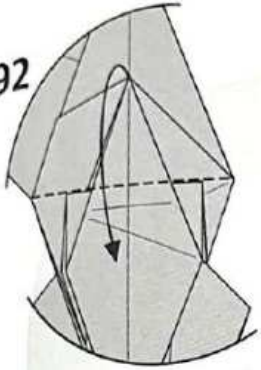

아래로 접어 내려주세요.

93

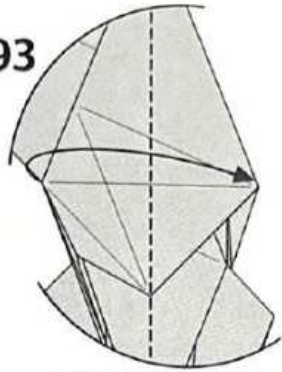

전체를 옆으로 넘기세요.

96

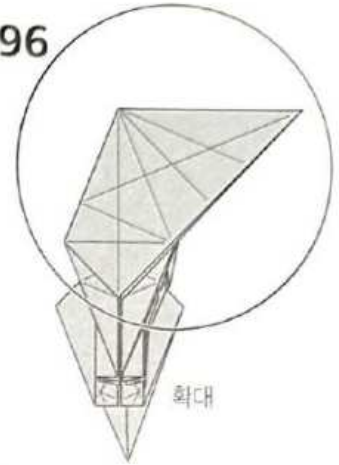

확대

91

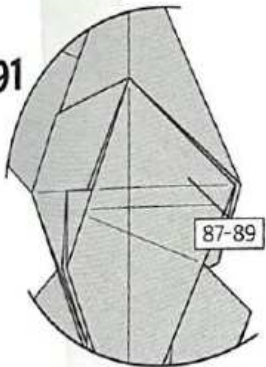

반대쪽도 87-89를 반복해 주세요.

94

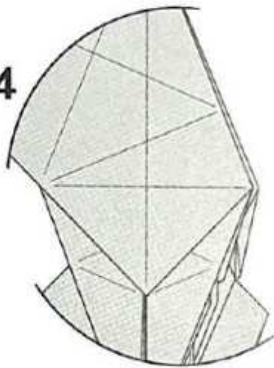

축소

95

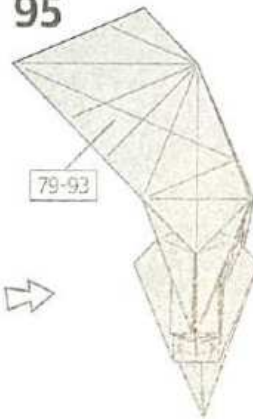

반대쪽도 79-93을 반복해 주세요.

90

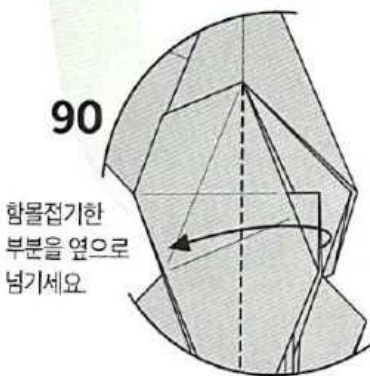

함몰접기한 부분을 옆으로 넘기세요.

89

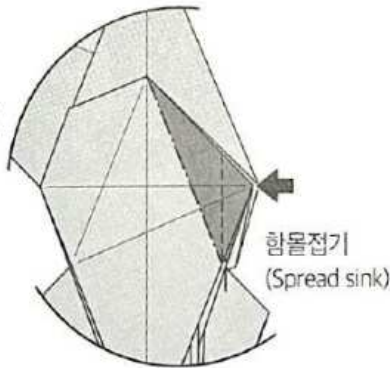

함몰접기 (Spread sink)

88

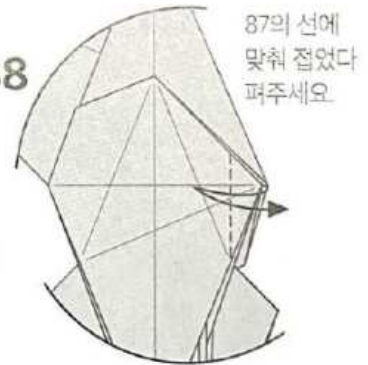

87의 선에 맞춰 접었다 퍼주세요.

84

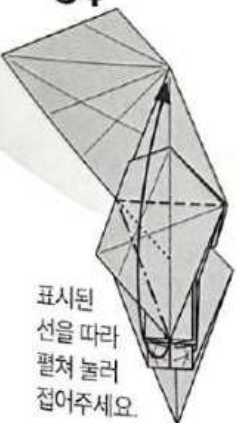

표시된 선을 따라 펼쳐 눌러 접어주세요.

85

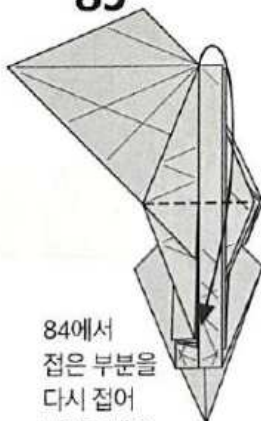

84에서 접은 부분을 다시 접어 내려주세요.

86

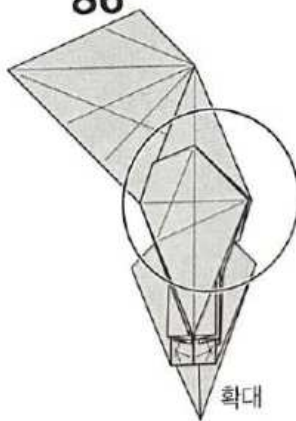

확대

87

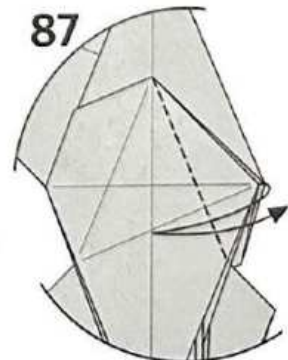

기운데 선에 맞춰 접었다 퍼주세요.

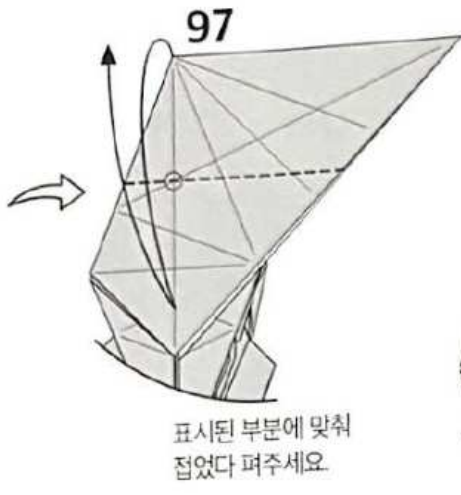

표시된 부분에 맞춰 접었다 펴주세요.

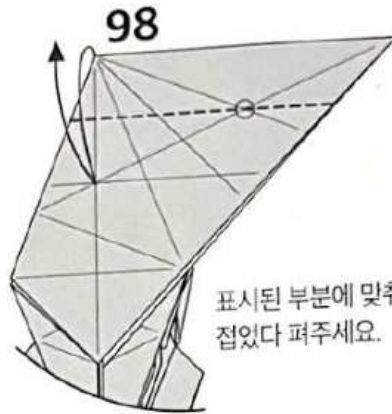

표시된 부분에 맞춰 접었다 펴주세요.



표시된 부분에 맞춰 한 겹을 접었다 펴주세요.

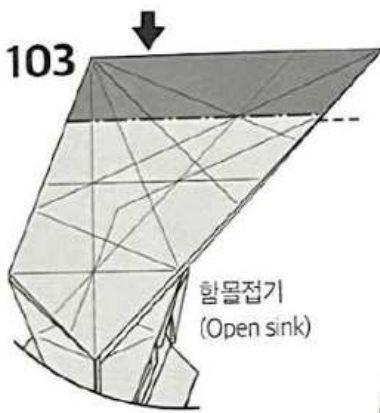

함몰접기 (Open sink)

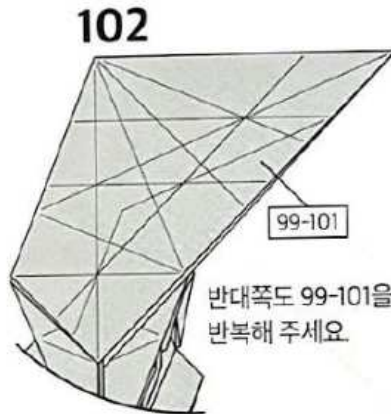

반대쪽도 99-101을 반복해 주세요.

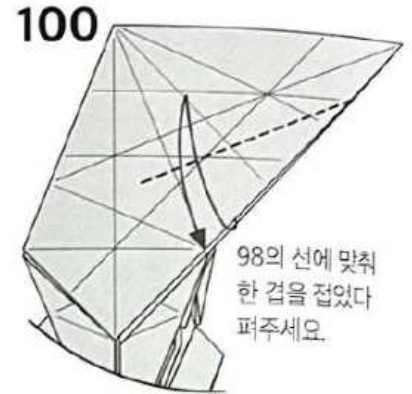

98의 선에 맞춰 한 겹을 접었다 펴주세요.

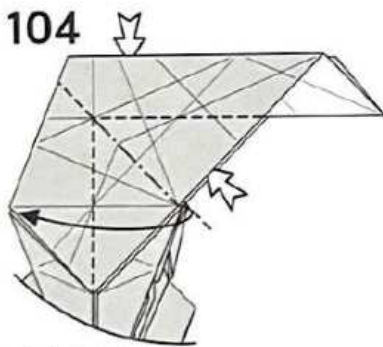

표시된 선을 따라 펼쳐 눌러 접어주세요.



표시된 선을 따라 한 겹을 접었다 펴주세요.

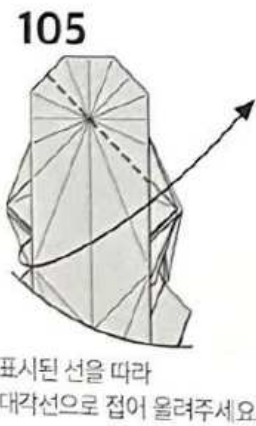

표시된 선을 따라 대각선으로 접어 올려주세요.



산골 표시에 유의하며 선을 따라 접어주세요.

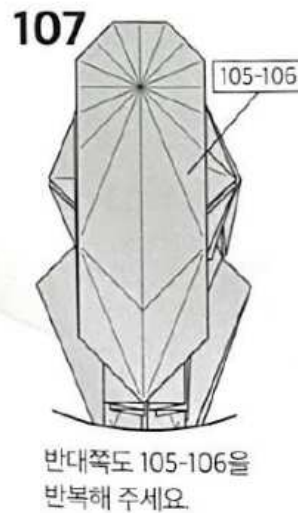

반대쪽도 105-106을 반복해 주세요.

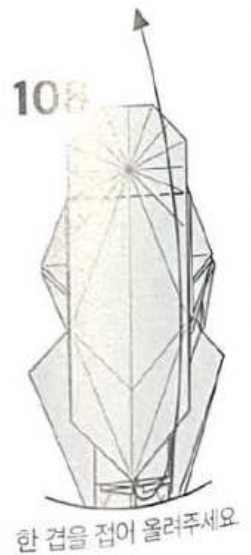

한 겹을 접어 올려주세요.





표시된 선을 따라  
접어 내려주세요.

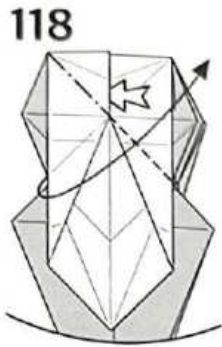

표시된 선을 따라  
펼쳐 눌러 접어주세요.

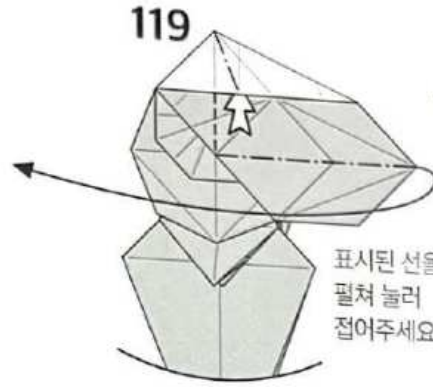

표시된 선을 따라  
펼쳐 눌러  
접어주세요.



안쪽에 접혀있는  
종이층을 빼주세요.

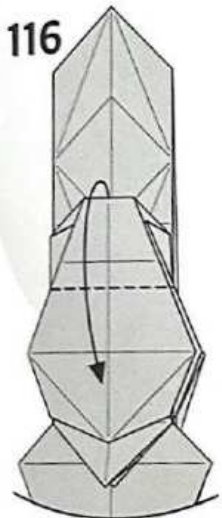

아래로 접어 내려주세요.

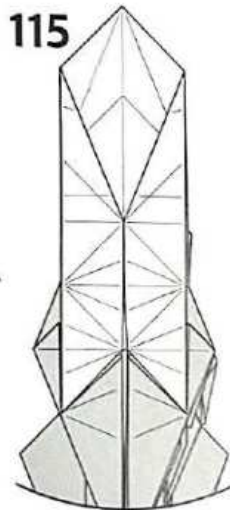

뒤집어 주세요.

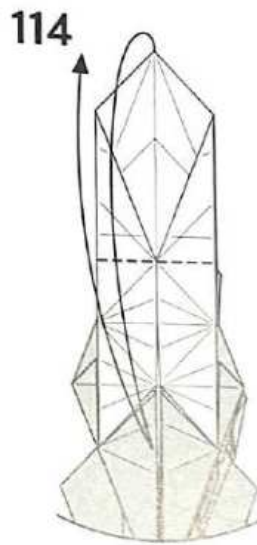

표시된 선을 따라  
접었다 펴주세요.

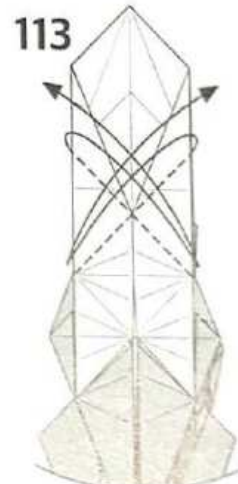

표시된 선을 따라  
접었다 펴주세요.

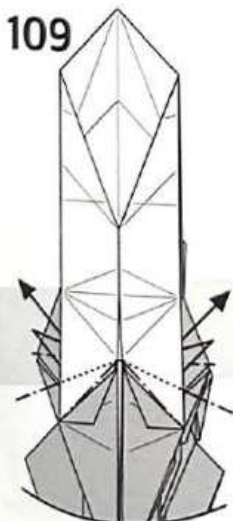

표시된 선을 따라 뒷쪽의  
종이층을 계단접기 해주세요.

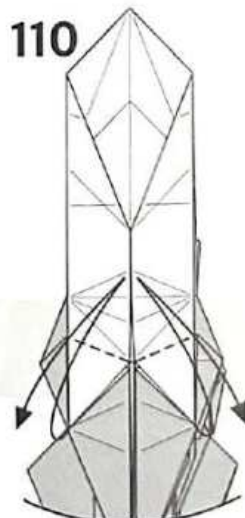

표시된 선을 따라  
접었다 펴주세요.

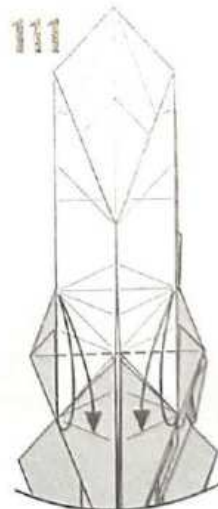

표시된 선을 따라  
접었다 펴주세요.



표시된 선을 따라  
접었다 펴주세요.

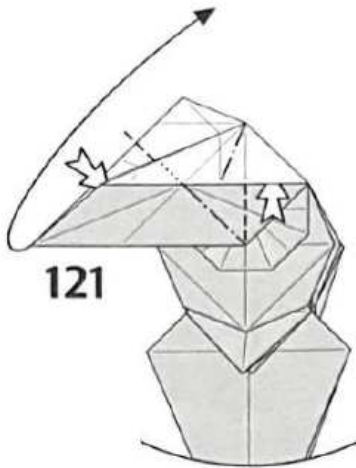

121

표시된 선을 따라 펼쳐 눌러 접어주세요.

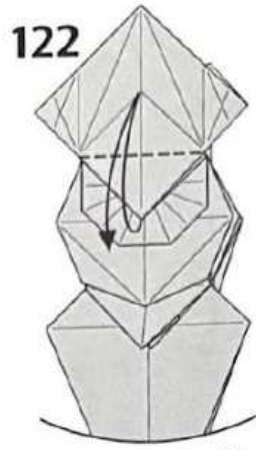

122

위로 접었다 펴주세요.

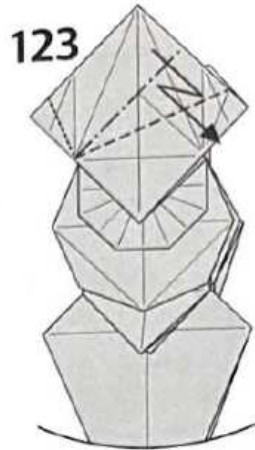

123

표시된 선을 따라 계단접기 해주세요.

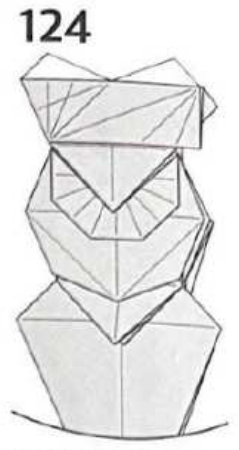

124

123에서 접은 부분을 다시 펼쳐 주세요.



128

표시된 선을 따라 펼쳐 눌러 접어주세요.

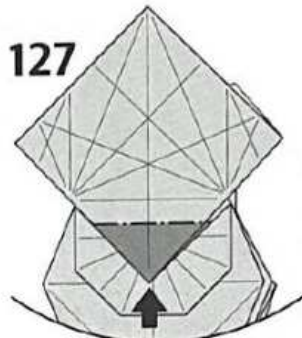

127

함몰접기 (Open sink)

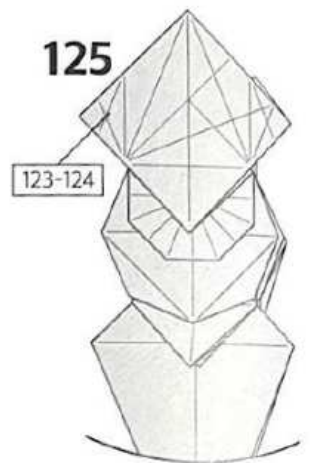

125

123-124

반대쪽도 123-124를 반복해 주세요.

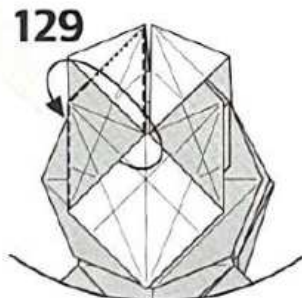

129

한 겹을 뒤집어 주세요.

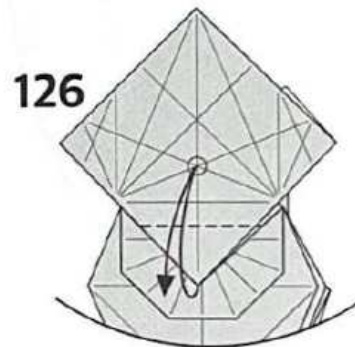

126

표시된 부분에 맞춰 접었다 펴주세요.



130

반대쪽도 129를 반복해 주세요.

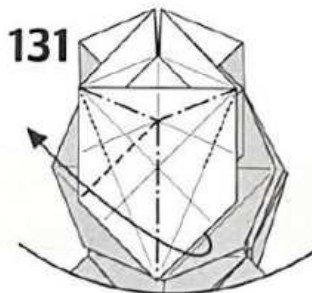

131

표시된 선을 따라 각을 모아 접어 주세요.

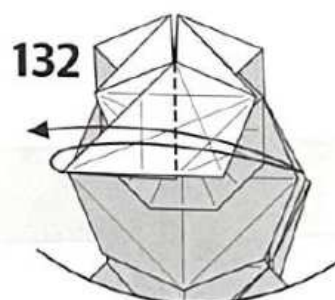

132

옆으로 접었다 펴주세요.

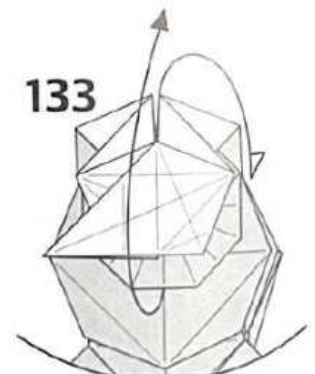

133

화살표를 따라 뒤집어 올려주세요.



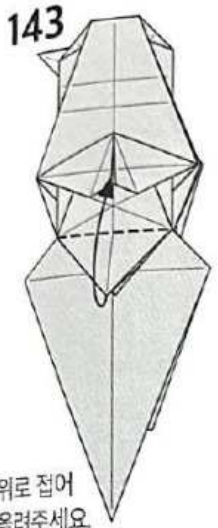

위로 접어 올려주세요

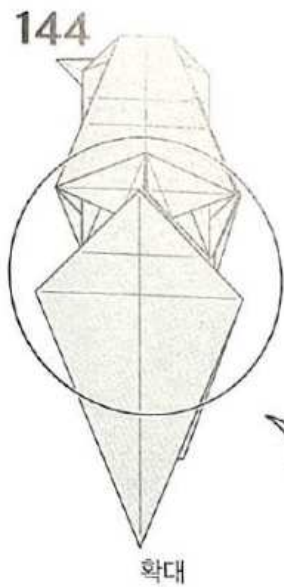

확대



함몰접기 (Open sink)

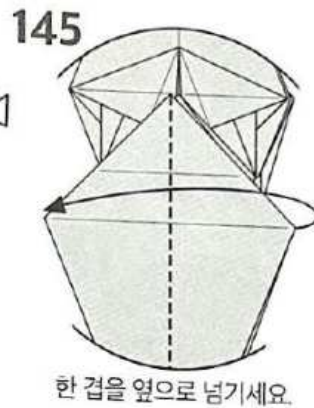

한 겹을 옆으로 넘기세요



표시된 선을 따라 접었다 펴주세요

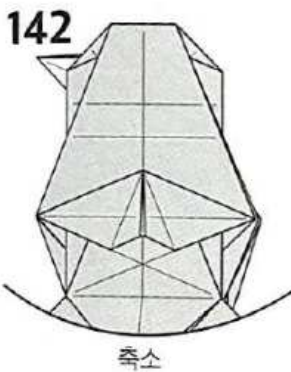

축소

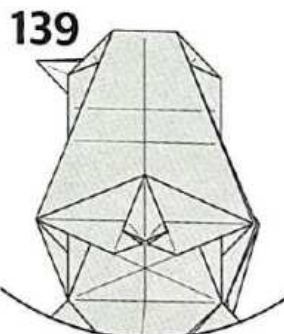

138에서 접은 부분을 다시 펼쳐 주세요

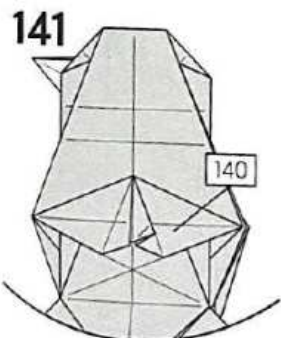

반대쪽도 140을 반복해 주세요

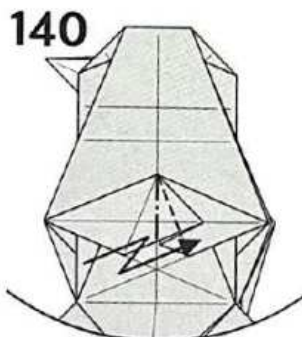

표시된 선을 따라 안쪽으로 계단접기 해주세요

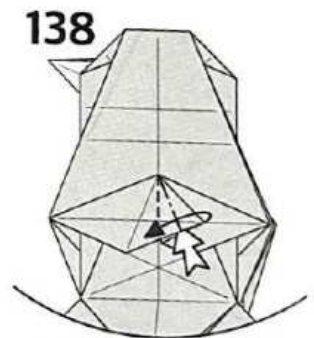

가운데 부분을 펼쳐 눌러 접어주세요

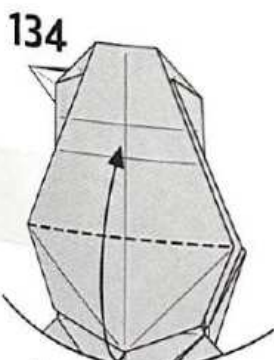

위로 접어 올려주세요

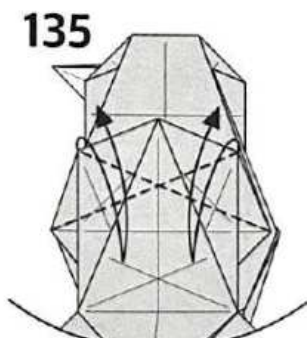

표시된 선을 따라 접었다 펴주세요

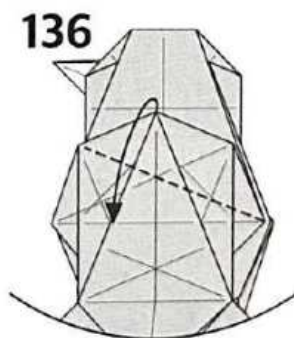

표시된 선을 따라 접어 주세요

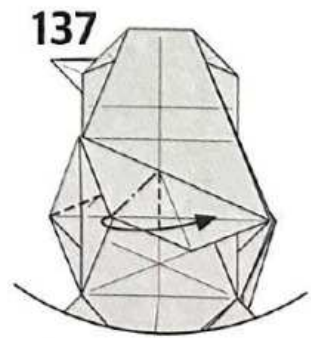

표시된 선을 따라 각을 모아 접어주세요

148

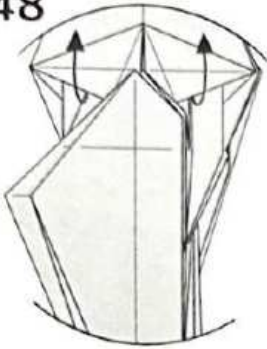

136-141에서 접은 부분을 잠시 펼쳐 주세요.

149

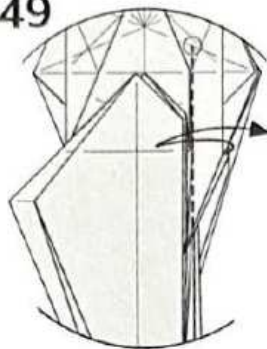

표시된 부분까지 접었다 퍼주세요.

150

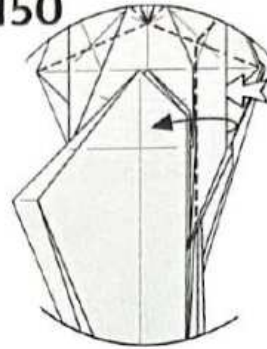

표시된 선을 따라 접으면서 148에서 펼친 부분도 다시 원상복귀 해주세요.

151



안쪽의 종이층을 앞으로 빼주세요.

155

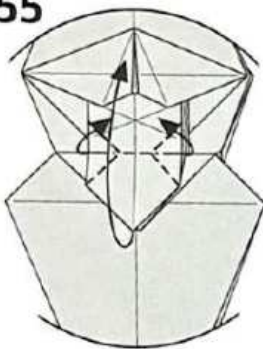

표시된 선을 따라 접어 주세요.

154

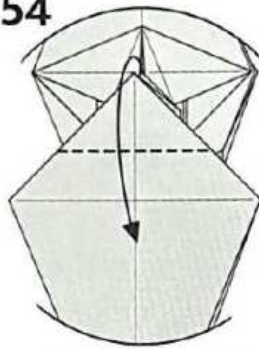

아래로 접어 내려주세요.

153

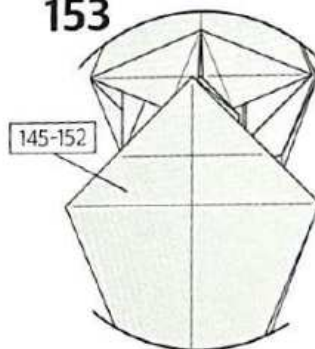

반대쪽도 145-152를 반복해 주세요.

152

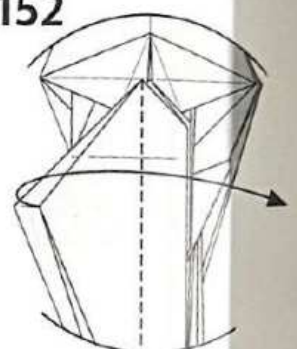

한 겹을 다시 옆으로 넘기세요.

156

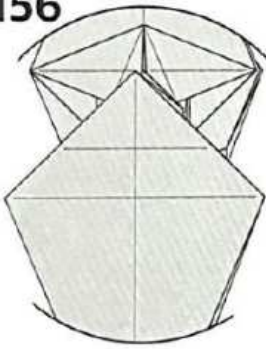

155에서 접은 부분을 다시 펼쳐 주세요.

158

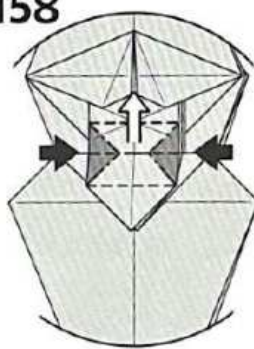

표시된 부분을 힘물접기 하면서 한 겹을 당겨 올려주세요.

160

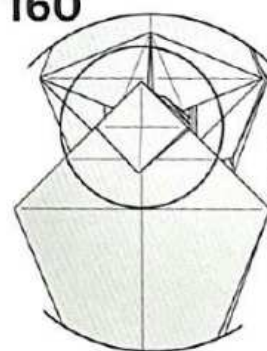

159에서 접은 부분을 봐주세요.

157

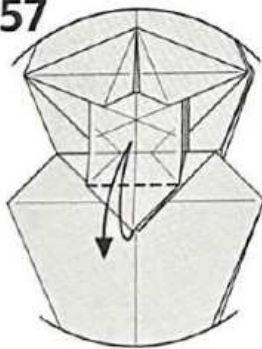

한 겹을 접었다 퍼주세요.

159

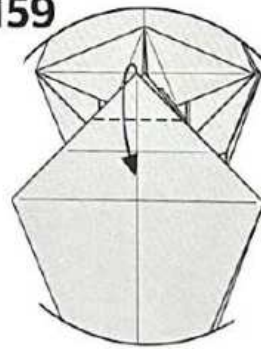

한 겹을 접어 내려주세요.

161

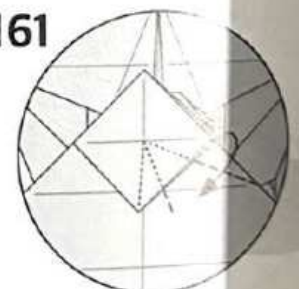

표시된 선을 따라 한 겹을 접어 주세요.



173

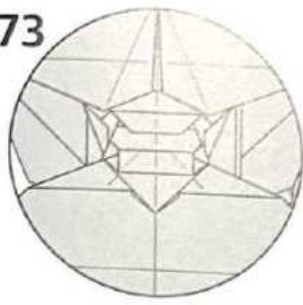

축소



174

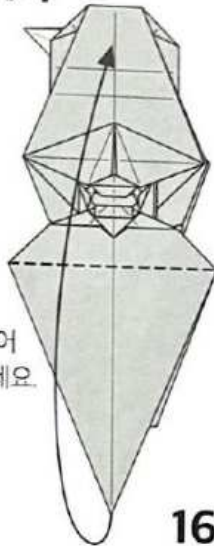

위로 접어 올려주세요.

175

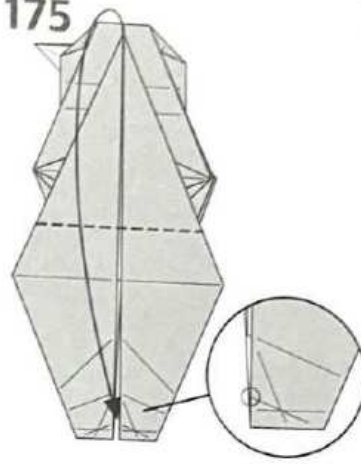

표시된 부분에 맞춰 접어 내려주세요.

176



표시된 부분에 맞춰 접었다 펴주세요.

172

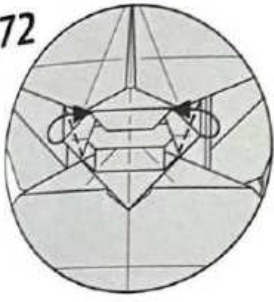

표시된 선을 따라 한 겹을 접어 주세요.

171

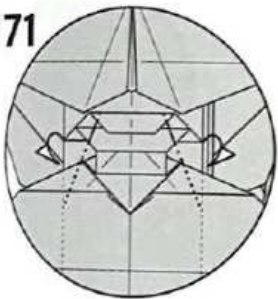

표시된 선을 따라 뒷쪽으로 접어 주세요.

170

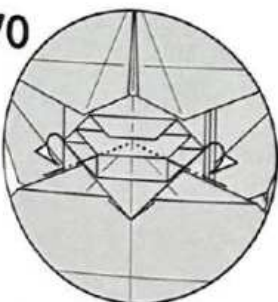

표시된 선을 따라 한 겹을 뒷쪽으로 접어 주세요.

169

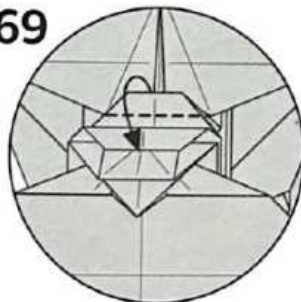

표시된 선을 따라 한 겹을 접어 내려주세요.

168

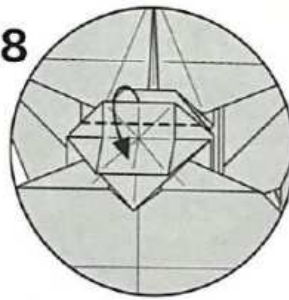

표시된 선을 따라 한 겹을 접어 내려주세요.

167

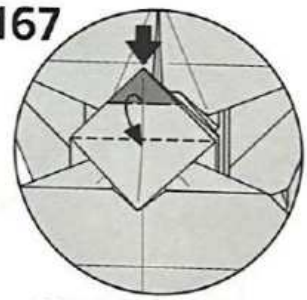

함몰접기 (Spread sink)

166

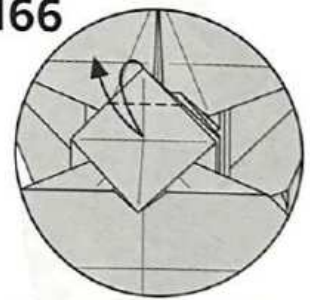

각을 반으로 접었다 펴주세요.

162

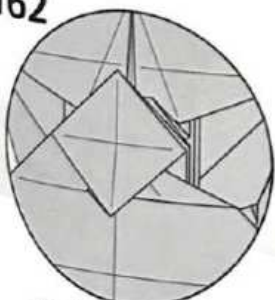

161에서 접은 부분을 다시 펼쳐 주세요.

163

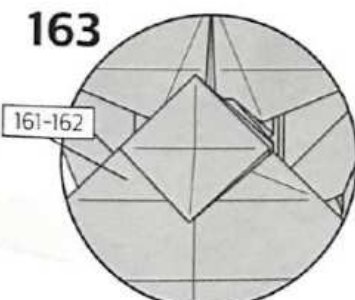

161-162

반대쪽도 161-162를 반복해 주세요.

164

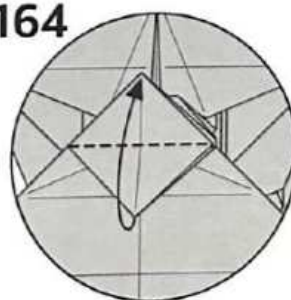

위로 접어 올려주세요.

165

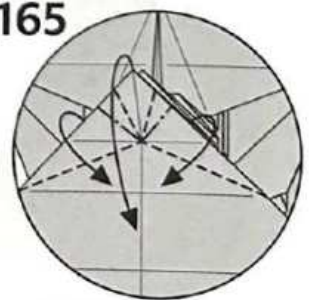

산골 표시에 유의하며 선을 따라 접어주세요.

177



표시된 부분에 맞춰  
접었다 펴주세요

178



175에서 접은 부분을  
다시 펼쳐 주세요

179

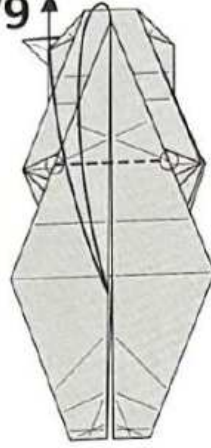

표시된 부분에 맞춰  
접었다 펴주세요

180

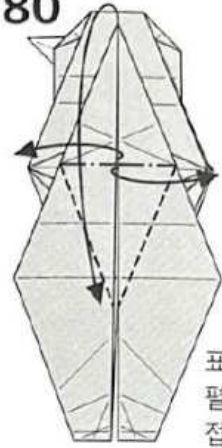

표시된 선을 따라  
펼쳐 눌러  
접어주세요

184

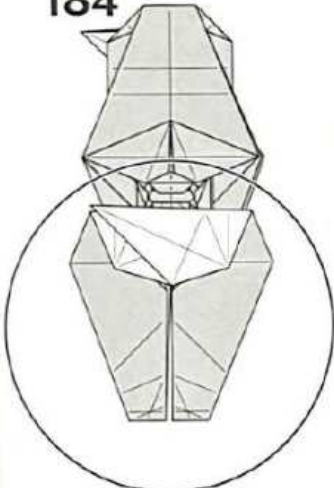

확대

183

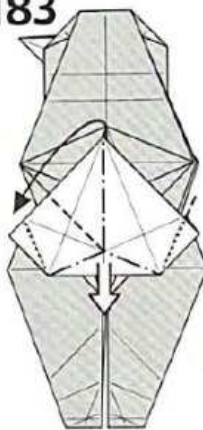

표시된 선을 따라  
각을 모아 접어 주세요

182

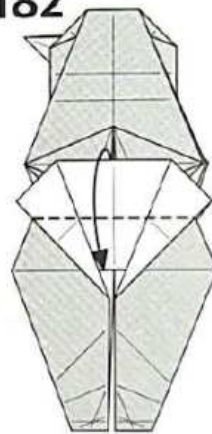

175의 선을 따라  
접어 내려주세요

181

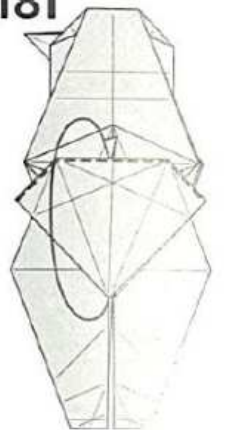

한 겹을 뒤집어 주세요

185

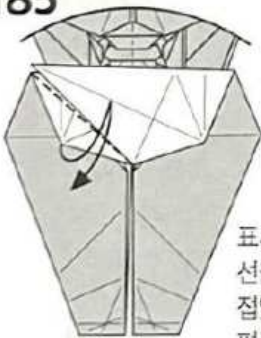

표시된  
선을 따라  
접었다  
펴주세요

187

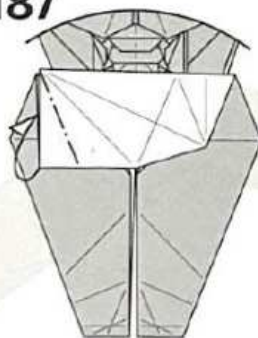

표시된 선을 따라  
뒷쪽으로 접어 주세요

188

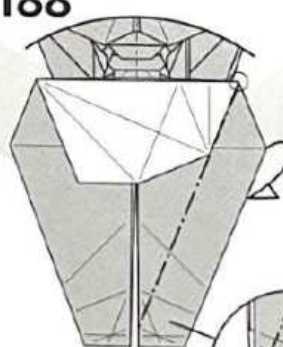

표시된 부분에 맞춰  
뒷쪽으로 접어 주세요

189

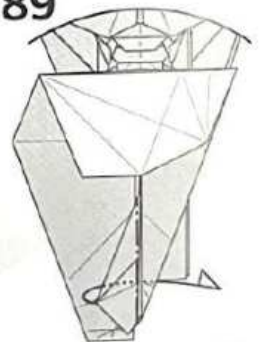

표시된 선을 따라  
뒷쪽으로 접어 주세요

186

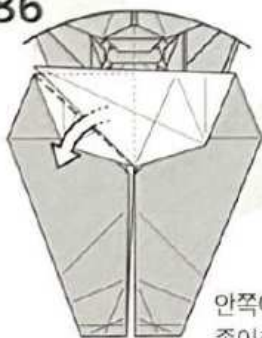

안쪽에 접혀있는  
종이층을 빼주세요

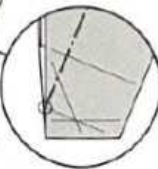



199

표시된 선을 따라 접어 주세요.

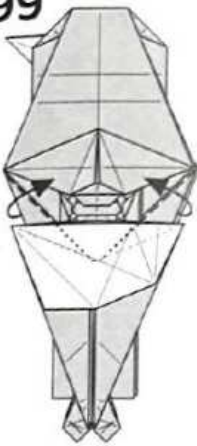

201

표시된 선을 따라 계단접기 해주세요

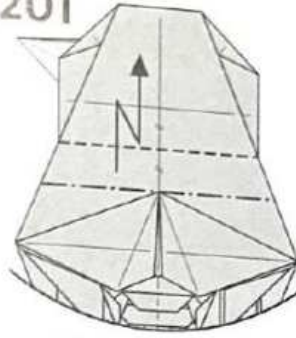

203

산골 표시에 유의하면서 검은 부분이 튀어나올 수 있도록 계단접기 해주세요.

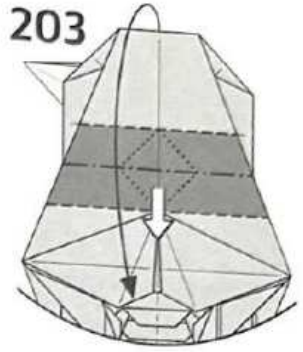

198

축소

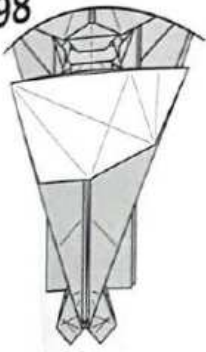

200

확대

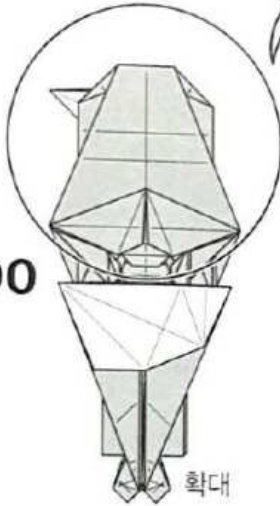

202

201에서 접은 부분을 다시 펼쳐 주세요.

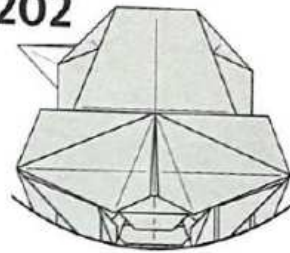

197

188-196

반대쪽도 188-196을 반복해 주세요.

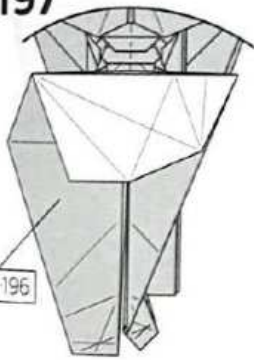

196

188-189의 선을 따라 다시 접어 주세요.

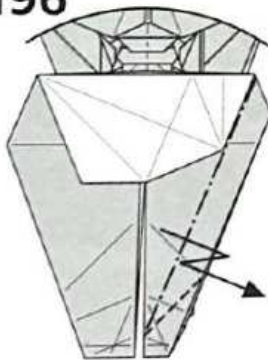

195

표시된 선을 따라 뒷쪽으로 접어 주세요.

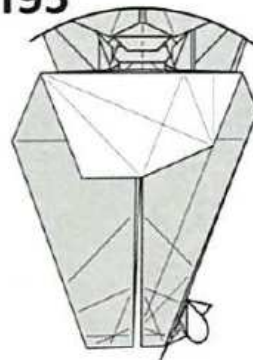

194

함몰접기 (Closed sink)

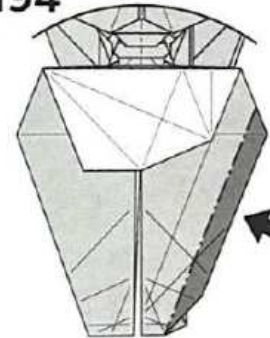

190

188-189에서 접은 부분을 다시 펼쳐 주세요.

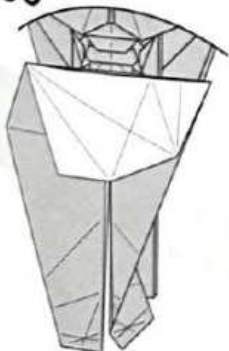

191

표시된 부분에 맞춰 접었다 퍼주세요.

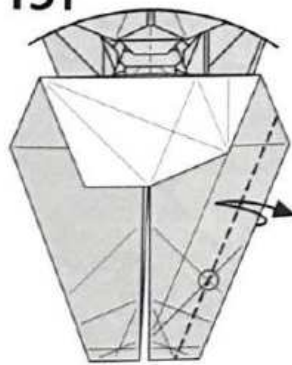

192

함몰접기 (Spread sink)

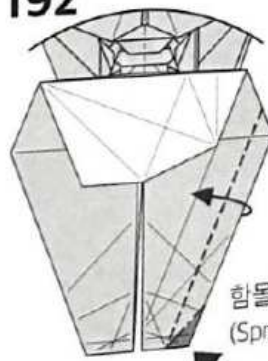

193

표시된 선을 따라 접어 주세요.

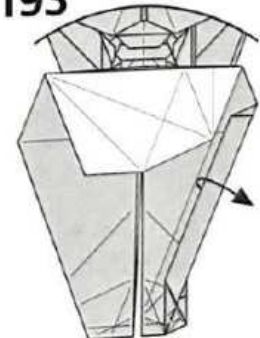

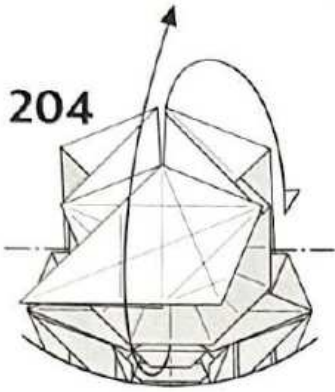

204 화살표를 따라 뒤집어 올려주세요.



205 안쪽의 종이층을 앞으로 빼주세요.

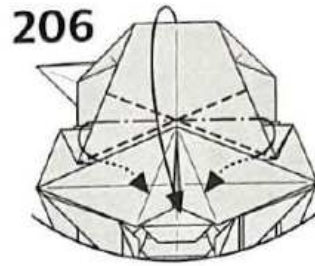

206 화살표에 유의하며 표시된 선을 따라 고정될 수 있도록 접어 주세요.

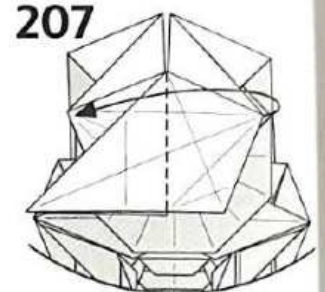

207 한 겹을 옆으로 넘기세요.

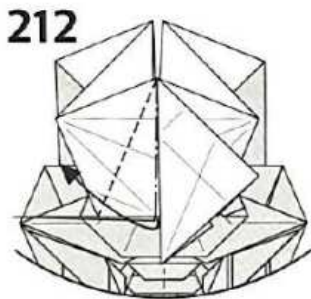

212 표시된 선을 따라 펼쳐 눌러 접어주세요.

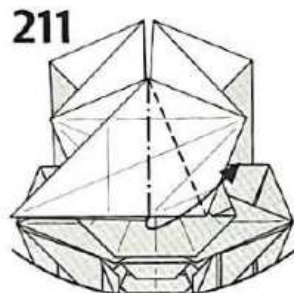

211 표시된 선을 따라 펼쳐 눌러 접어주세요.

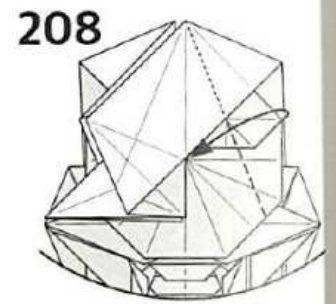

208 가운데 선에 맞춰 반으로 접어 주세요.

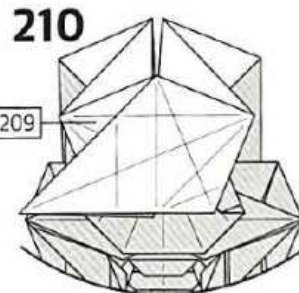

210 반대쪽도 207-209를 반복해 주세요.

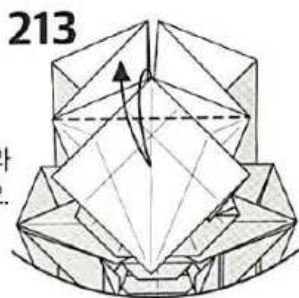

213 표시된 선을 따라 접었다 펴주세요.

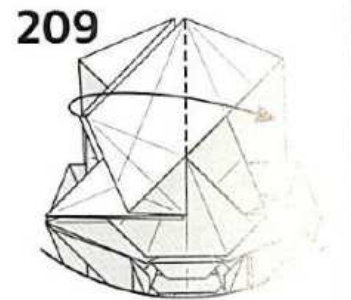

209 한 겹을 다시 옆으로 넘기세요.

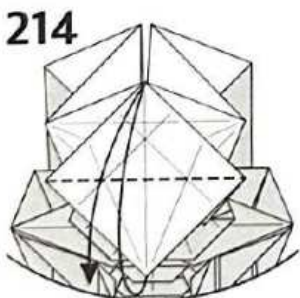

214 한 겹을 반으로 접었다 펴주세요.

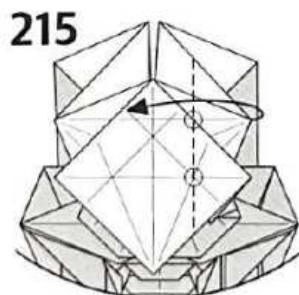

215 표시된 부분에 맞춰 접어주세요.

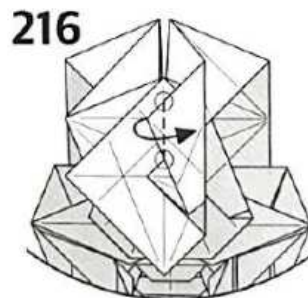

216 표시된 부분에 맞춰 접어주세요.



217 215에서 접은 부분만 펼쳐주세요.



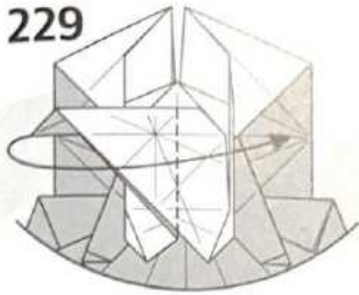

229 옆으로 넘기세요.

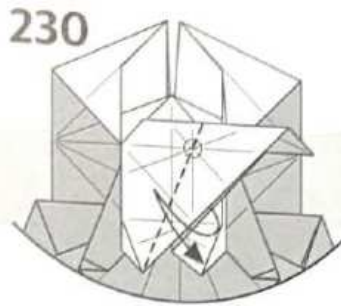

230 표시된 부분에 맞춰 한 겹을 접었다 펴주세요.

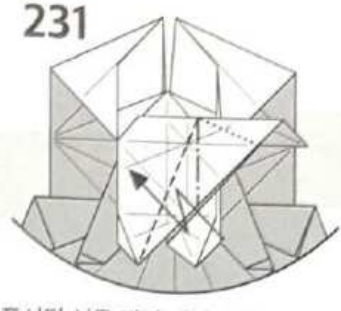

231 표시된 선을 따라 계단접기 해주세요.



228 표시된 부분에 맞춰 한 겹을 접었다 펴주세요.



223 표시된 선을 따라 접었다 펴주세요.

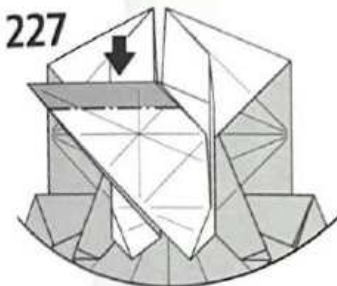

227 함몰접기 (Open sink)

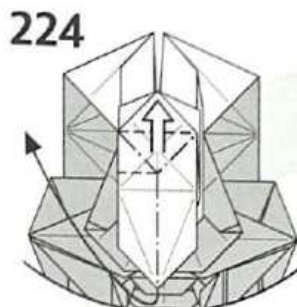

224 흰색 화살표 부분이 튀어나올 수 있도록 각을 모아 접어 주세요.

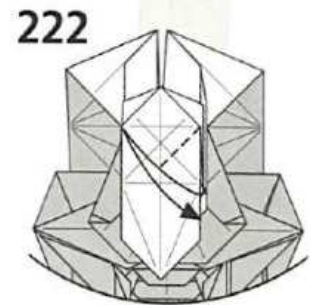

222 표시된 선을 따라 접었다 펴주세요.

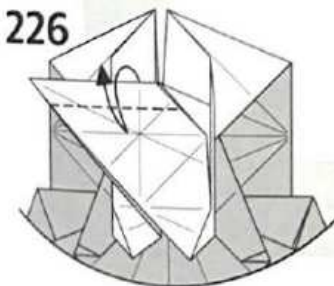

226 반으로 접었다 펴주세요.



225 224에서 접은 부분을 봐주세요.

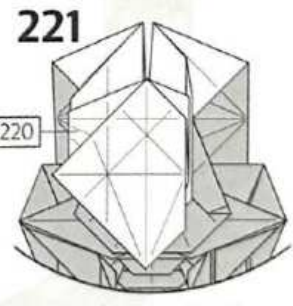

221 반대쪽도 219-220을 반복해 주세요.



218 반대쪽도 215-217을 반복해 주세요.

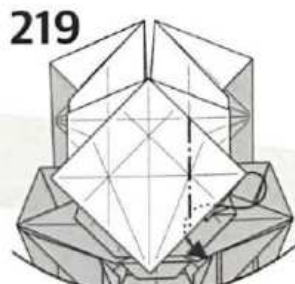

219 안쪽으로 펼쳐 눌러 접어주세요. (Inside reverse fold)

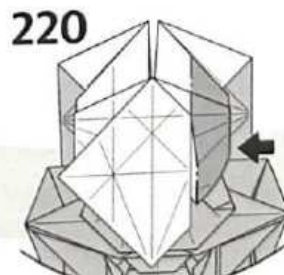

220 함몰접기 (Closed sink)

232

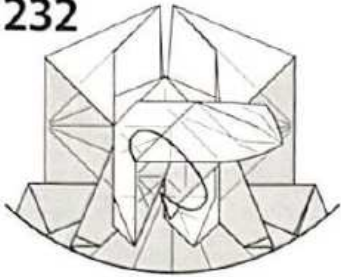

231에서 접은 부분을 안쪽으로 접어 주세요.

233

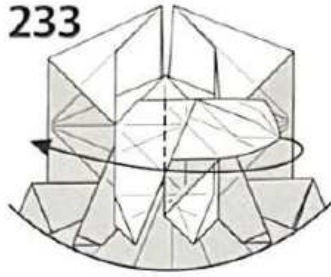

표시된 선을 따라 옆으로 넘기세요.

234

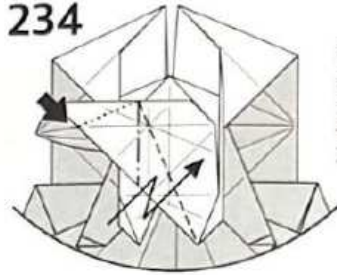

검은 화살표 부분을 함몰시키면서 표시된 선을 따라 계단접기 해주세요.

240



안쪽의 종이층을 봐주세요.

239



표시된 선을 따라 펼쳐 눌러 접어주세요.

235

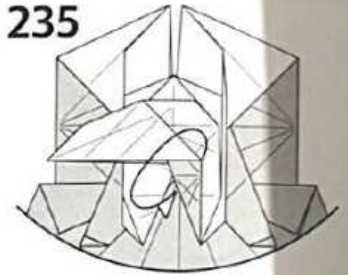

234에서 접은 부분을 안쪽으로 접어 주세요.

236

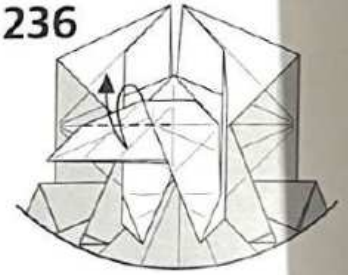

한 겹을 접었다 펴주세요.

241

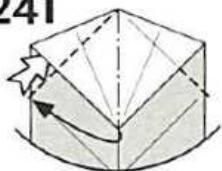

표시된 선을 따라 각을 모아 접어 주세요.

238

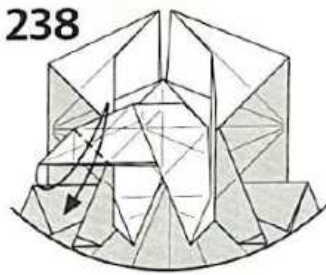

45도로 접었다 펴주세요.

237

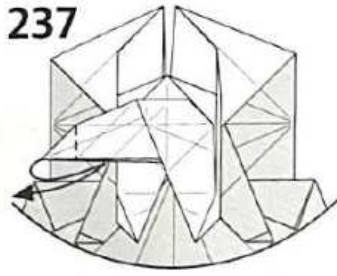

수직으로 접었다 펴주세요.

242

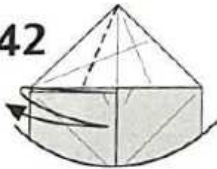

가운데 선에 맞춰 한 겹을 반으로 접었다 펴주세요.

243

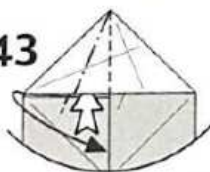

펼쳐 눌러 접어주세요.

244



안쪽에 접혀있는 종이층을 앞으로 빼주세요.

245



표시된 부분에 맞춰 접었다 펴주세요.

246



안쪽으로 펼쳐 눌러 접어주세요. (Inside reverse fold)





표시된 선을 따라 계단접기 해주세요.



표시된 선을 따라 펼쳐 눌러 접어주세요.

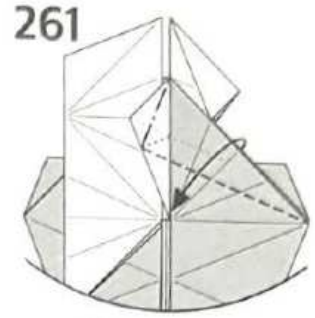

표시된 선을 따라 펼쳐 눌러 접어주세요.

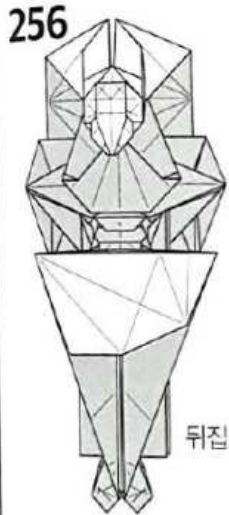
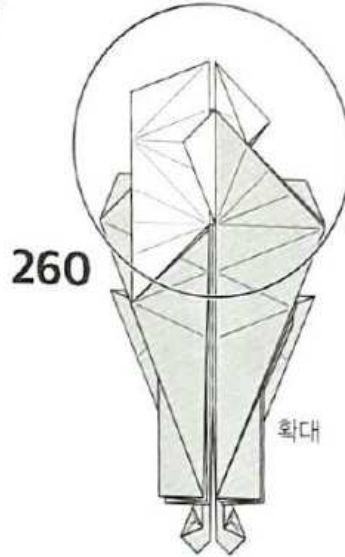
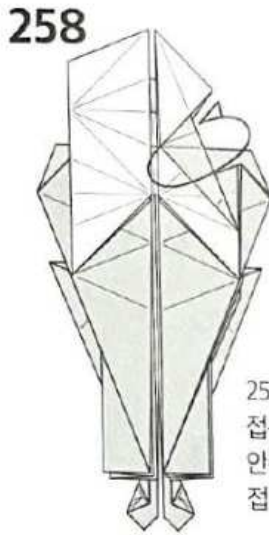

뒤집어 주세요.

257에서 접은 부분을 안쪽으로 접어 주세요

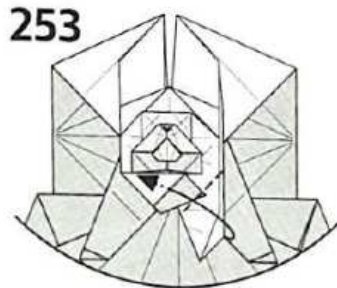

반대쪽도 대각선으로 접어 올리면서 252에서 접은 곳으로 끼워 넣으세요.

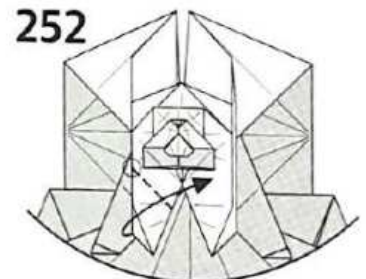

표시된 부분에 맞춰 대각선으로 접어 올려주세요.

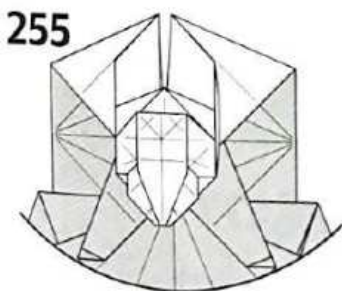

축소

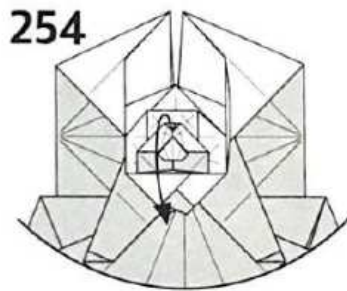

251에서 올린 부분을 다시 내려 주세요.

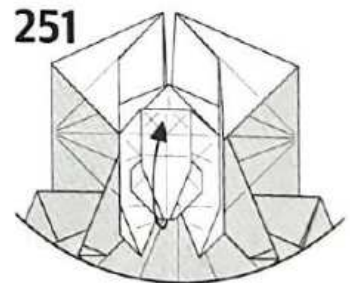

한 겹을 들어올려 안쪽을 봐주세요.

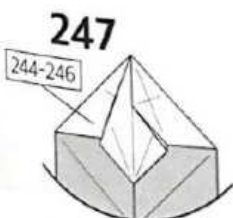

반대쪽도 244-246을 반복해 주세요.

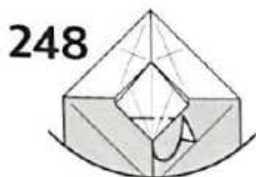

표시된 선을 따라 뒷쪽으로 접어 주세요.



표시된 선을 따라 끝부분을 접어 내려주세요.



축소

262

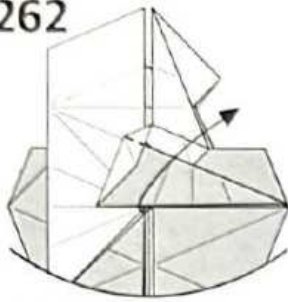

대각선으로 접어 올려주세요.

263

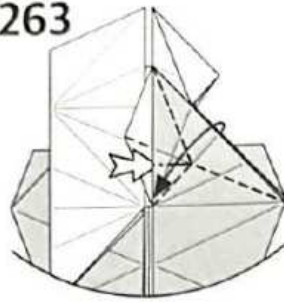

표시된 선을 따라 한 겹을 펼쳐 눌러 접어주세요.

264

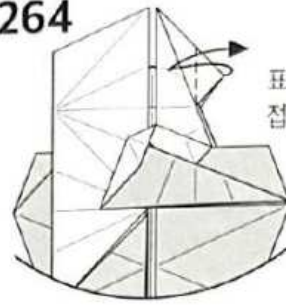

표시된 선을 따라 접었다 펴주세요.

265

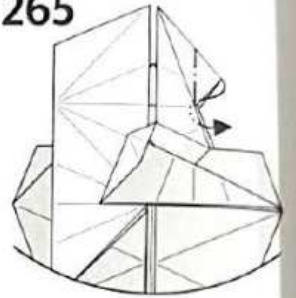

안쪽으로 펼쳐 눌러 접어주세요.  
(Inside reverse fold)

268

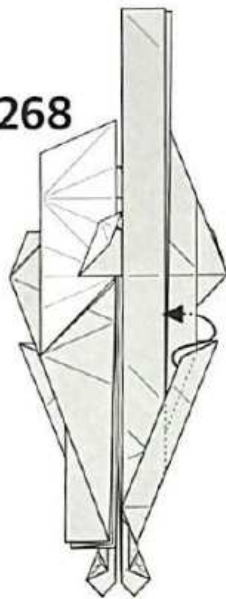

앞쪽의 종이층 두 겹을 뒤로 보내 주세요.

267

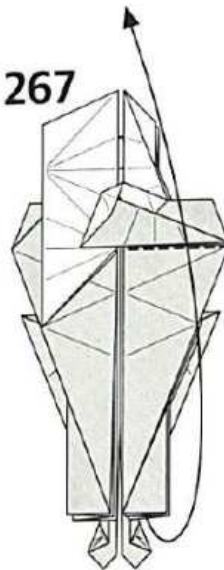

위로 접어 올려주세요.

266

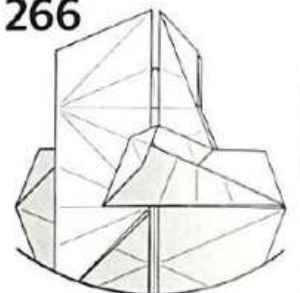

축소

269

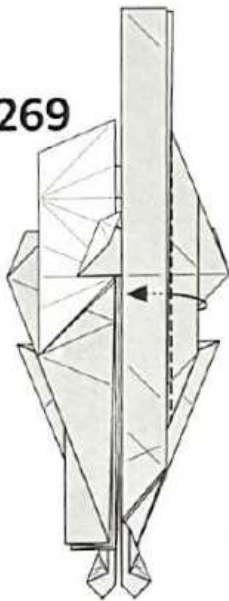

안쪽으로 접어 넣으세요.

270

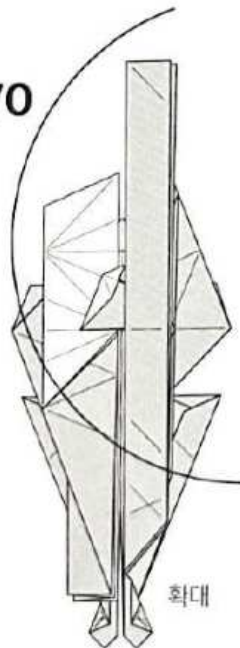

확대

271

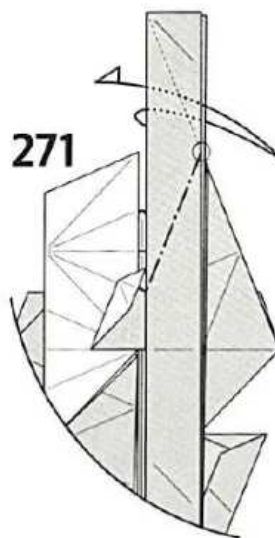

표시된 부분에 맞춰 접었다 펴주세요.

272

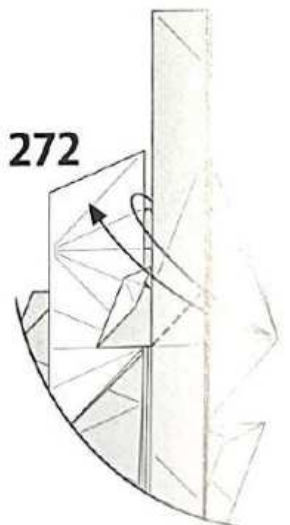

표시된 선을 따라 45도로 접었다 펴주세요.



280

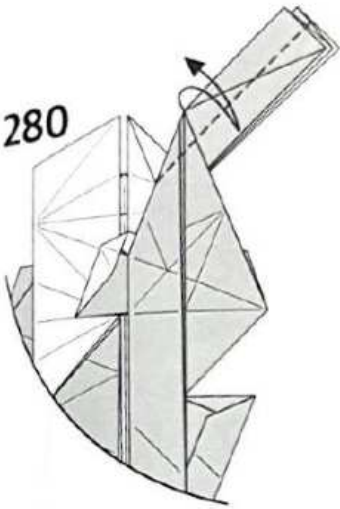

279에서 접은 부분 전체를 반으로 접었다 펴주세요.

281

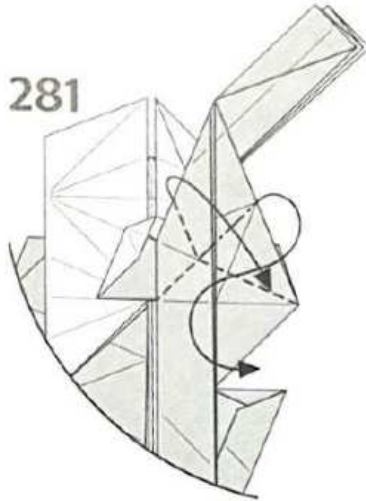

274의 선을 이용해서 다시 접어 주세요.

282



어깨 부분의 안쪽을 펴주세요.

279

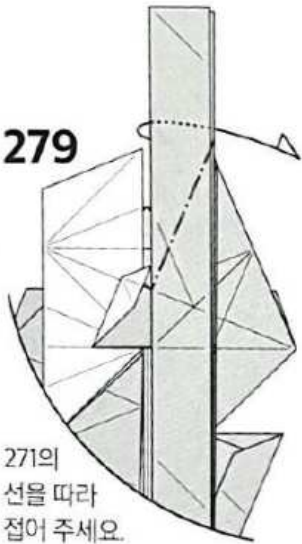

271의 선을 따라 접어 주세요.

278

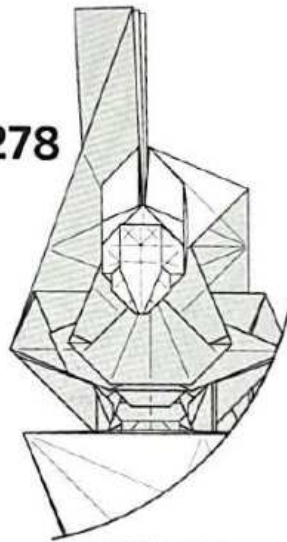

뒤집어 주세요.

277

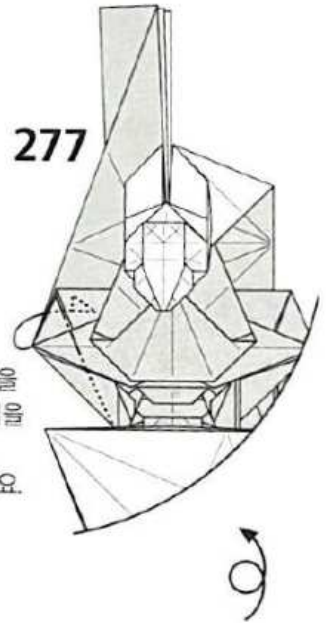

표시된 선을 따라 한 겹을 뒷쪽으로 접어 주세요.

273

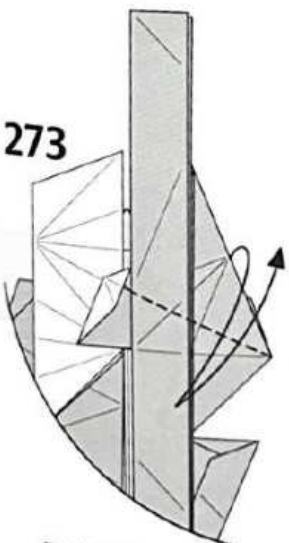

표시된 선을 따라 22.5도로 접었다 펴주세요.

274

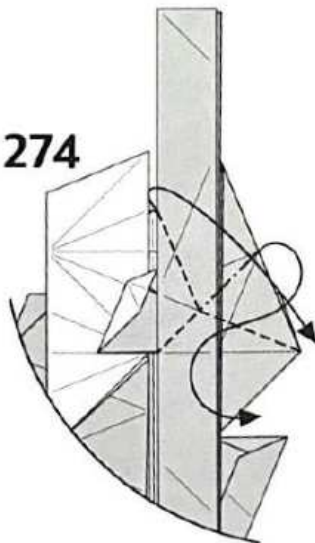

산골 표시에 유의하며 선을 따라 접어주세요.

275

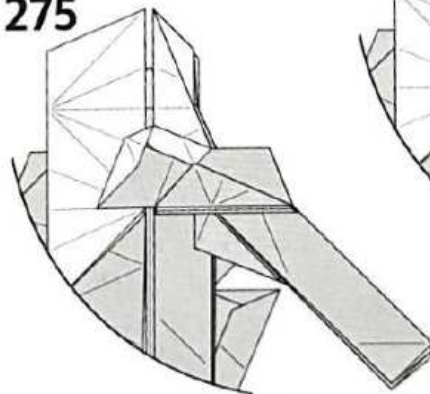

274에서 접은 부분을 다시 펼쳐 주세요.

276

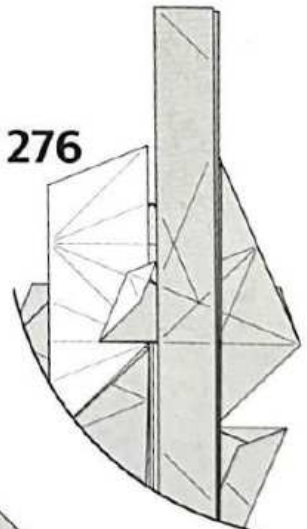

뒤집어 주세요.

283



표시된 선을 따라  
접어 주세요.

284

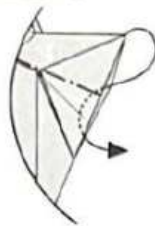

안쪽으로 펼쳐 눌러  
접어주세요.  
(Inside reverse fold)

285



축소

286



표시된 선을 따라  
대각선으로 접어  
내려주세요.

290

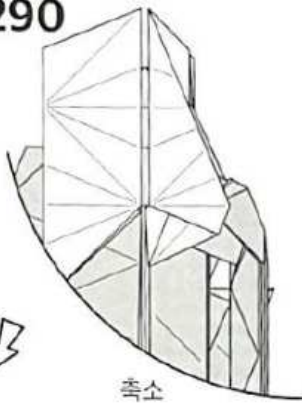

축소

289

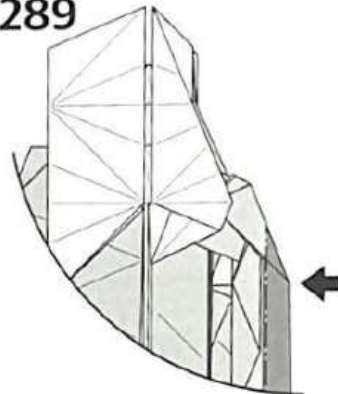

바깥쪽의 종이층을 반으로  
함몰접기 해주세요. (Closed sink)

287

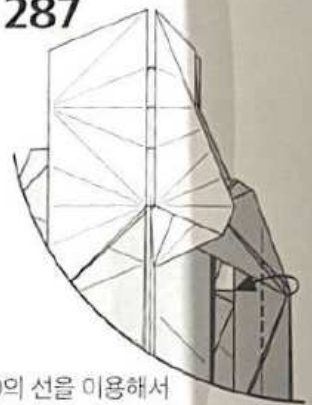

280의 선을 이용해서  
안쪽의 각을 반으로 접어주세요.

291



반대쪽도  
257-289를  
반복해 주세요.

288

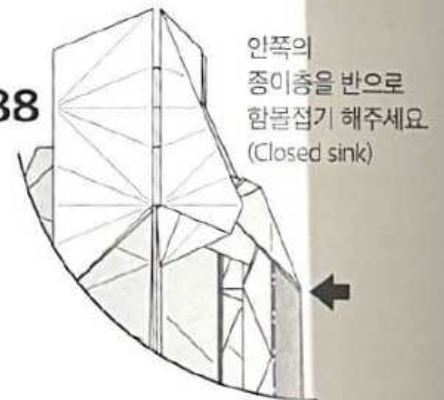

안쪽의  
종이층을 반으로  
함몰접기 해주세요.  
(Closed sink)

293



표시된 선을 따라  
안쪽으로 접어  
올려주세요.

294

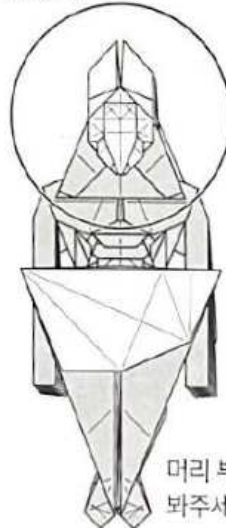

머리 부분을  
봐주세요

292



뒤집어 주세요.

295

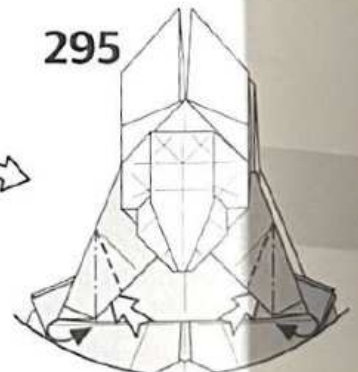

표시된 선을 따라  
펼쳐 눌러 접어주세요.



303

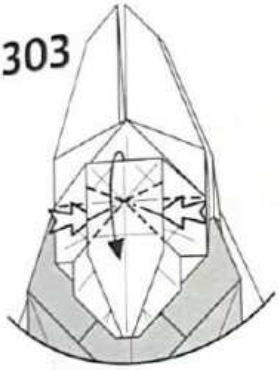

301의 선을 기준으로 하여 표시된 선을 따라 접어 주세요.

304



가운데 선에 맞춰 뒷쪽으로 접어 주세요.

307

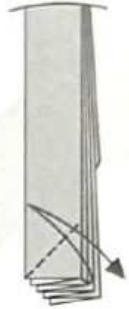

맨앞의 종이층을 45도로 접었다 펴주세요.

302

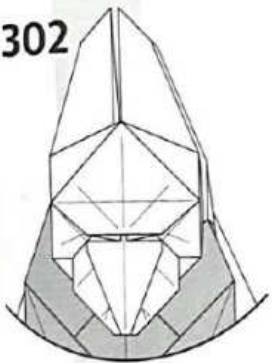

301에서 접은 부분을 다시 펼쳐 주세요.

305

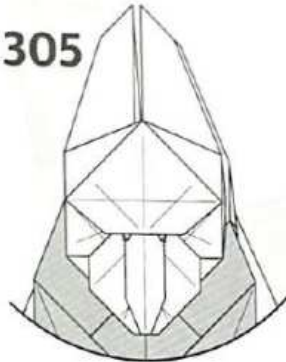

축소

306

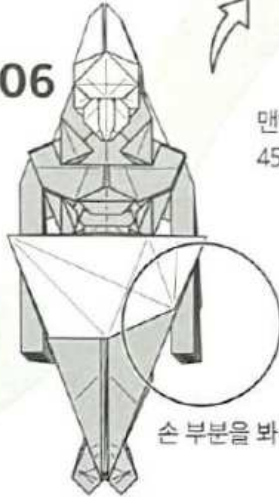

손 부분을 봐주세요.

301

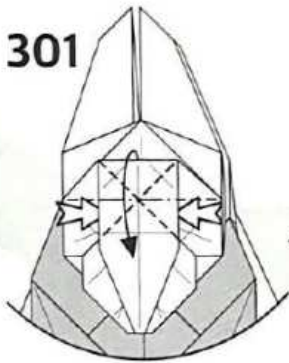

표시된 선을 따라 펼쳐 눌러 접어주세요.

300

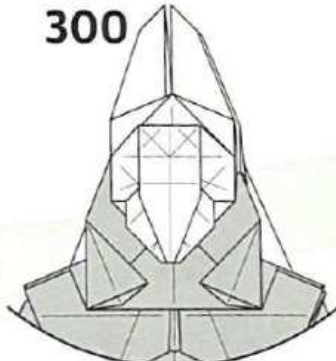

얼굴 부분을 봐주세요.

299

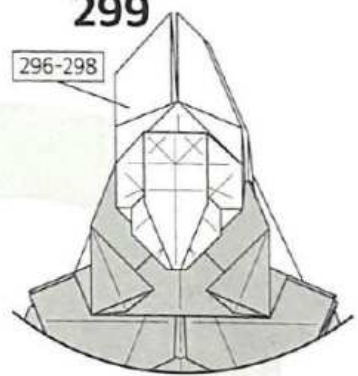

반대쪽도 296-298을 반복해 주세요.

296

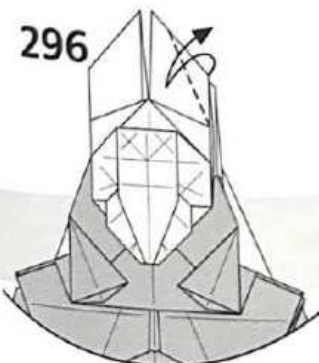

표시된 선을 따라 접었다 펴주세요.

297

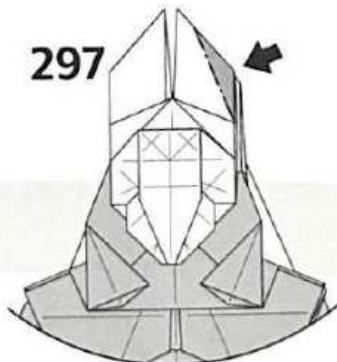

함몰접기 (Closed sink)

298

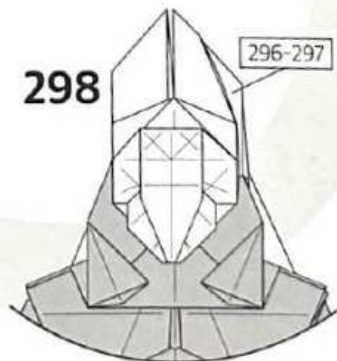

뒷쪽도 296-297을 반복해 주세요.

308

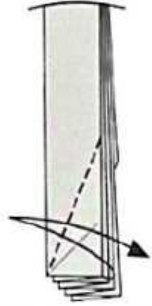

307의 선을 이용하여  
22.5도로 접었다 펴주세요.

309

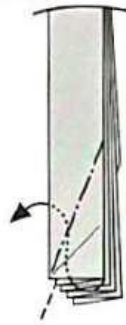

안쪽으로 펼쳐  
눌러 접어주세요.  
(Inside reverse fold)

310



안쪽으로 펼쳐  
눌러 접어주세요.  
(Inside reverse fold)

311

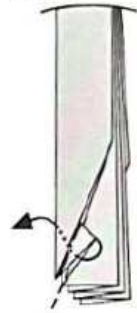

안쪽으로 펼쳐  
눌러 접어주세요.  
(Inside reverse fold)

317

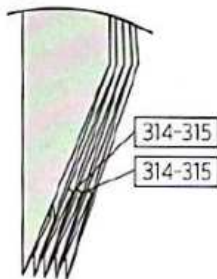

뒷쪽도 314-315를  
두 번 반복해 주세요.

316

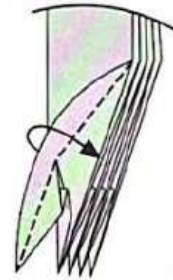

들어올린 부분을  
다시 덮으세요.

315

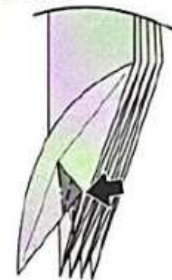

함몰접기  
(Spread sink)

314

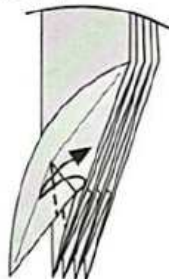

안쪽의 각을 반으로  
접었다 펴주세요.

312

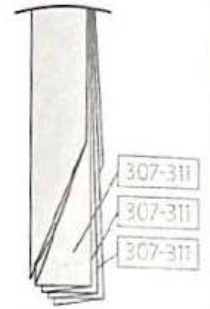

뒷쪽도 307-311을  
반복해 주세요.

313



한 칸  
들어올린  
안쪽을  
펼쳐주세요.

318

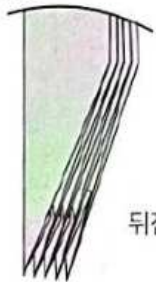

뒤집어 주세요.

321

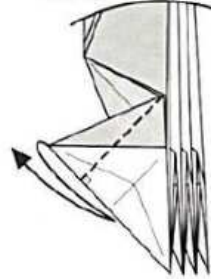

표시된 선을 따라  
접었다 펴주세요.

322

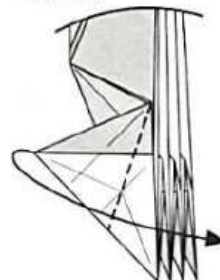

321의 선을 이용하여  
22.5도로 접어 주세요.

319

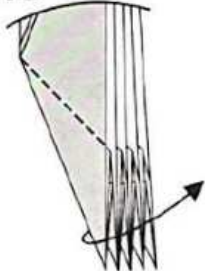

맨앞의 종이층을  
펼쳐주세요.

320

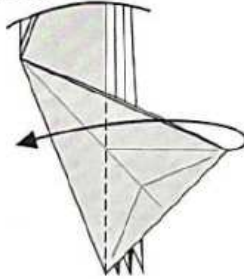

표시된 선을 따라  
접어 주세요.

323

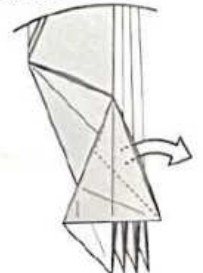

안쪽에 접혀있는  
종이층을 빼주세요.



334



축소

333



뒤집어 주세요.

332

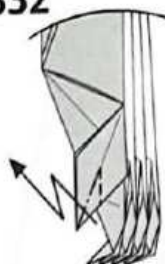

엄지손가락을 뽀족하게  
다듬어주세요.

335

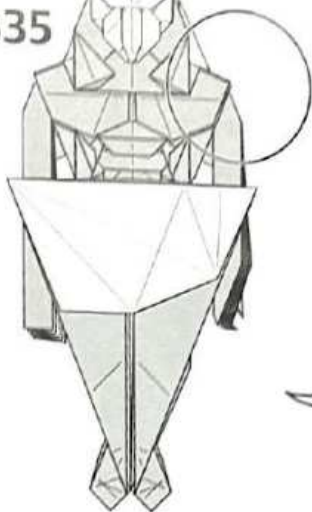

어깨 부분을 봐주세요.

337



축소

336

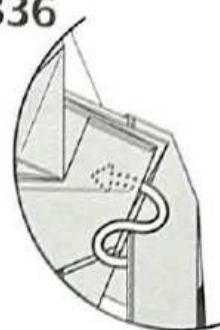

가운데 종이층을 팔 부분의  
안쪽으로 끼워 넣으세요.

331

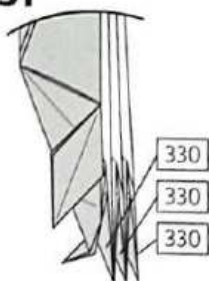

뒷쪽도 330을  
반복해 주세요.

330



안쪽으로 펼쳐  
눌러 접어주세요.  
(Inside reverse fold)

329

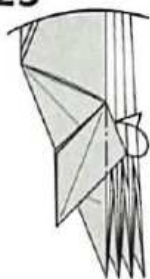

표시된 선을 따라  
뒷쪽으로  
접어 주세요.

328



안쪽으로 펼쳐  
눌러 접어주세요.  
(Inside reverse fold)

324



안쪽으로 펼쳐  
눌러 접어주세요.  
(Inside reverse fold)

325

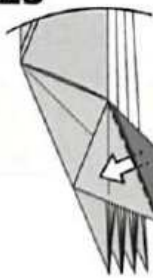

안쪽에 접혀있는  
종이층 한 겹을  
빼주세요.

326

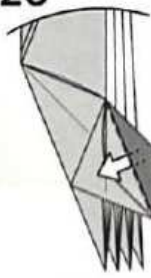

안쪽에 접혀있는  
종이층을 빼주세요.

327



표시된 선을 따라  
접어 주세요.

338

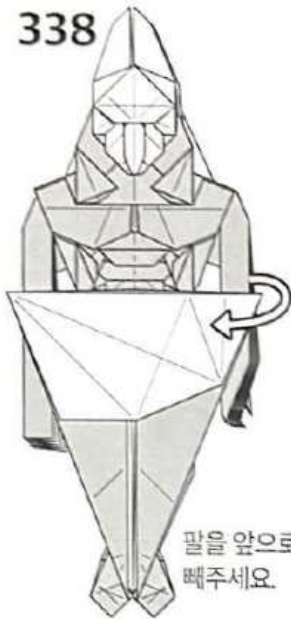

팔을 앞으로  
펼치세요.

339



307-338

반대쪽도  
307-338을  
반복해 주세요.

340



뒤집어 주세요.

341

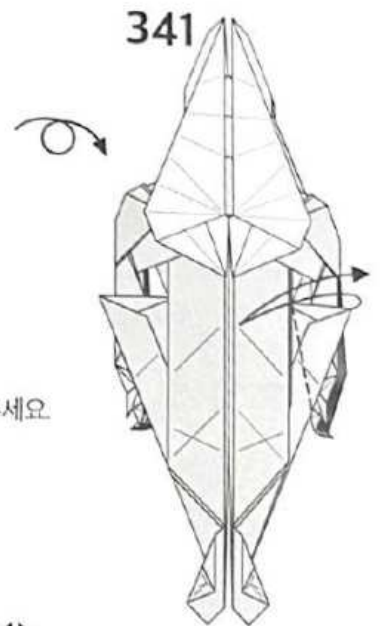

가운데 선에 맞춰  
접었다 펴주세요.

344



뒤집어 주세요.

343



341-342

반대쪽도  
341-342를  
반복해 주세요.

342



종이층을 펼치면서  
엉덩이 부분을  
덮어주세요.

345

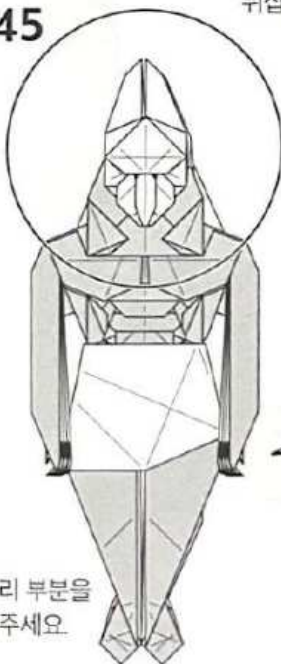

머리 부분을  
뺐주세요.

346

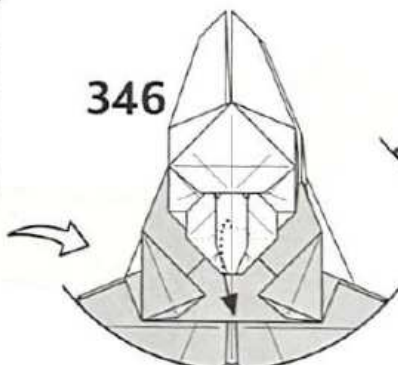

안쪽에 접혀있는  
코와 입을 꺼내세요.

347

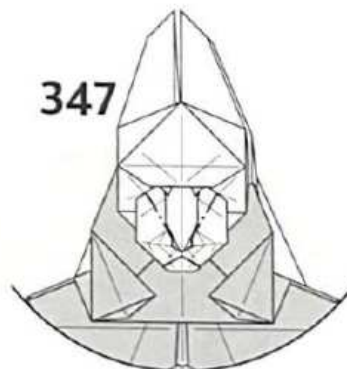

코잔등을 다듬어주세요.

348

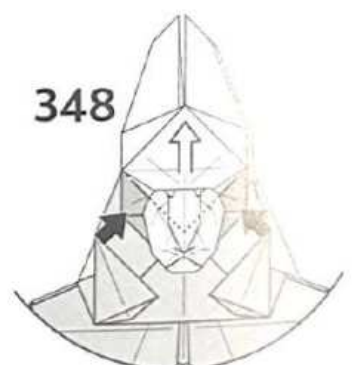

얼굴과 이마를 부풀리면서  
다듬어주세요.



356

복근 모양을  
다듬어주세요.

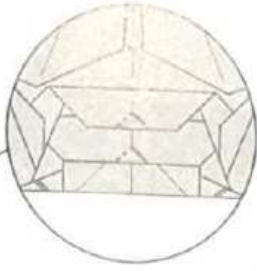
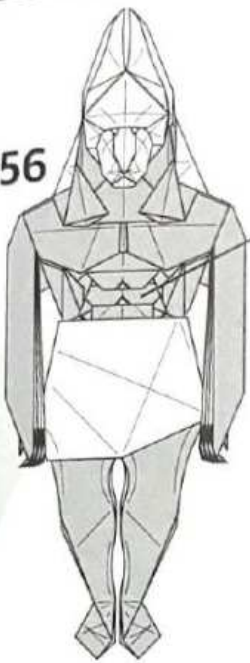

358

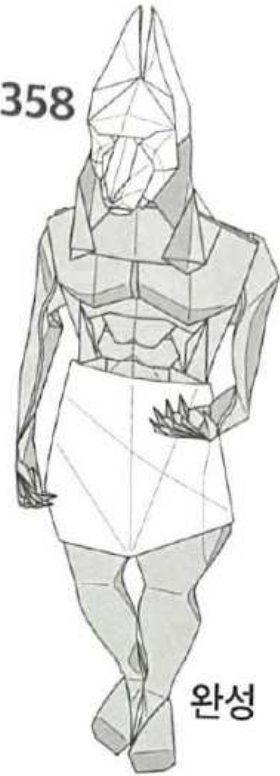

완성

357

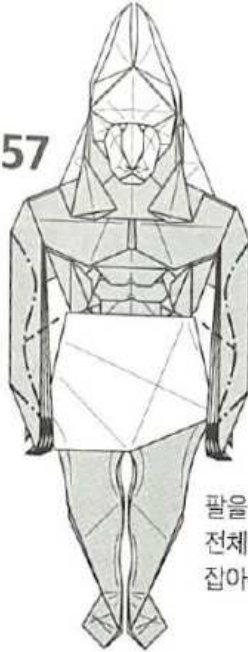

팔을 다듬으면서  
전체적인 동세를  
잡아주세요.

355



축소

352

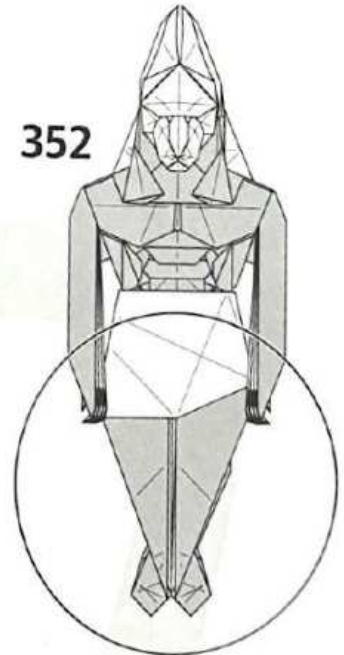

다리 부분을 봐주세요.

354



종아리와 발목을  
다듬어주세요.

353



허벅지 모양을  
다듬어주세요.

349

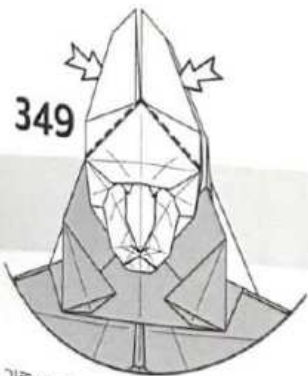

귀를 약간 펼치면서 다듬어주세요.

350

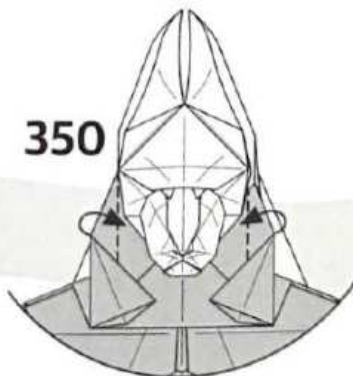

장신구를 세우면서 다듬어주세요.

351

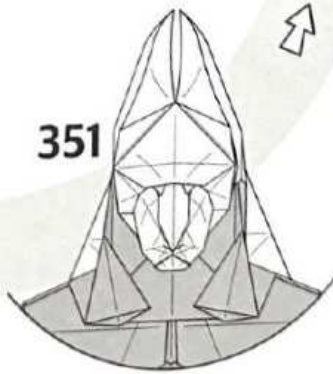

축소

# 포세이돈 ◆ 423 step

## Poseidon

Creator : 이인섭 (Lee In Seop)

Diagram : 이인섭 (Lee In Seop)

Size : 90cm x 90cm

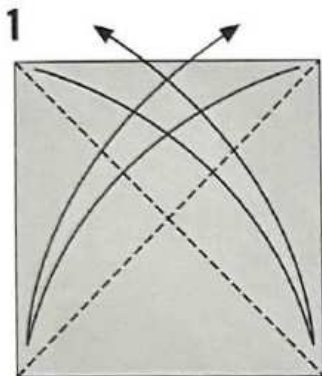
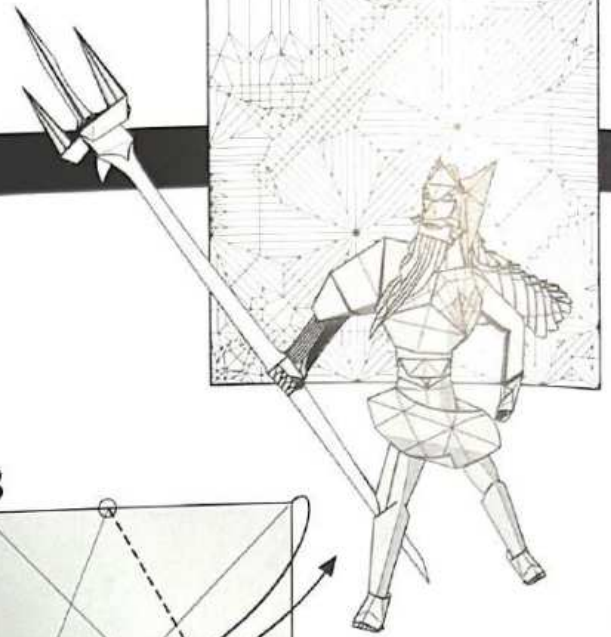

1 접었다 편 선을 내주세요.

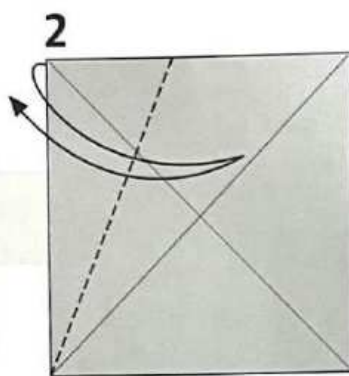

2 접었다 편 선을 내주세요.

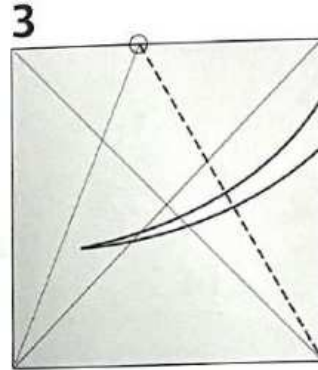

○와 모서리  
잇는 선으로 접었다  
편 선을 내주세요.

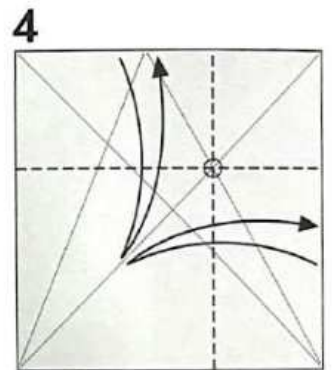

4 ○부분에서 접었다 편  
선을 내주세요.

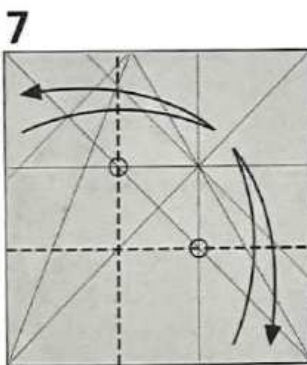

7 ○부분에서 접었다 편  
선을 내주세요.

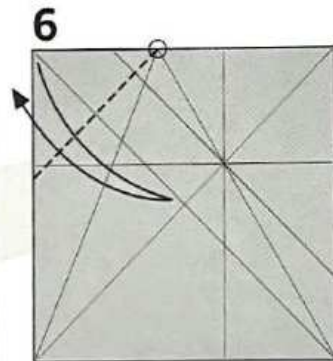

6 ○부분에서 접었다 편  
선을 내주세요.

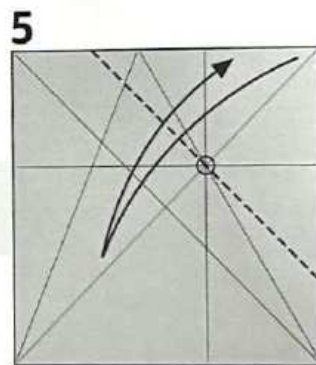

5 ○부분에서 접었다 편  
선을 내주세요.

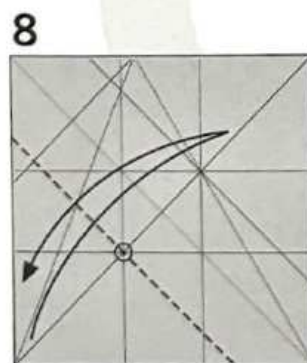

8 ○부분에서 접었다 편  
선을 내주세요.

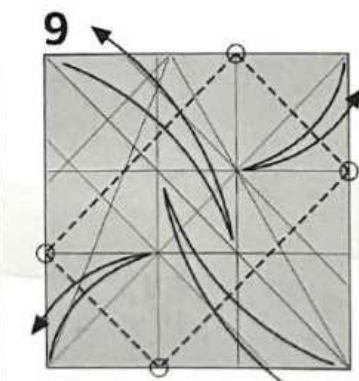

9 ○를 잇는 선으로  
접었다 편 선을 내주세요.

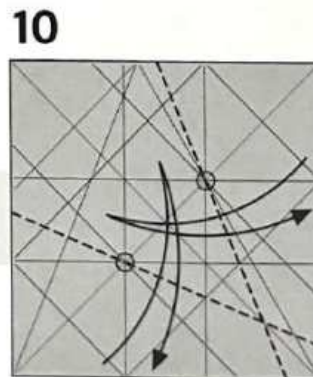

10 ○부분에서 접었다 편  
선을 내주세요.



11 ○부분에서 접었다 편  
선을 내주세요.



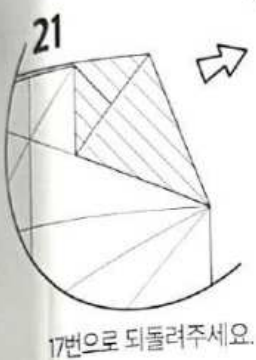

17번으로 되돌려주세요.

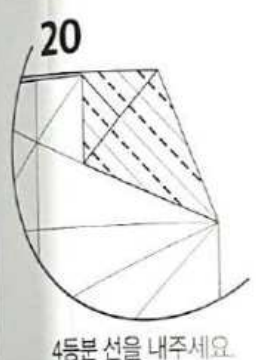

4등분 선을 내주세요.



2등분 선을 내주세요.

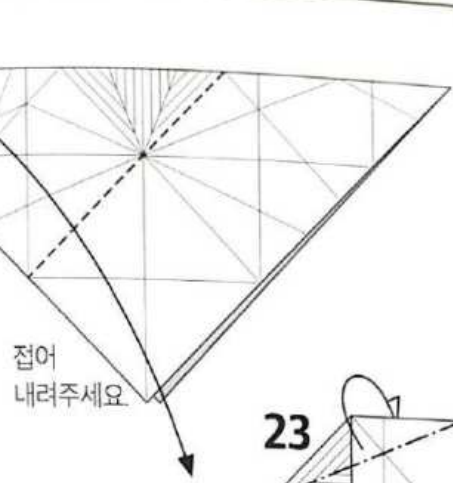

접어 내려주세요.

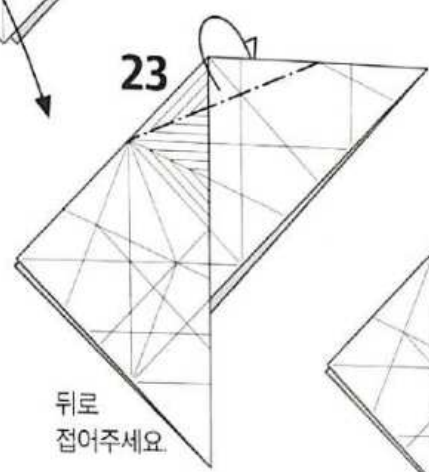

뒤로 접어주세요.



4등분 선을 내주세요.

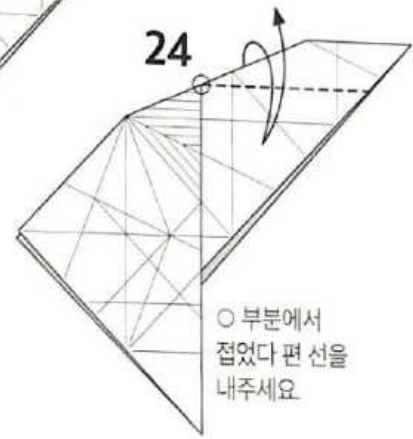

○ 부분에서 접었다 편 선을 내주세요.

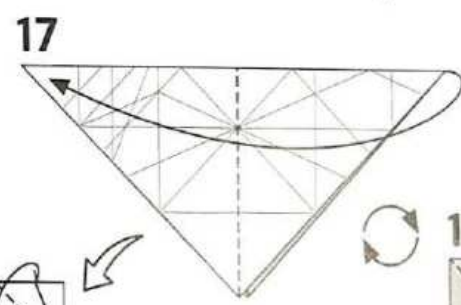

반으로 접어주세요.



펼쳐 눌러 접어주세요.

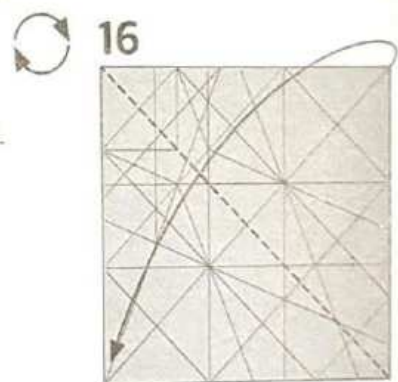

반으로 접어주세요.

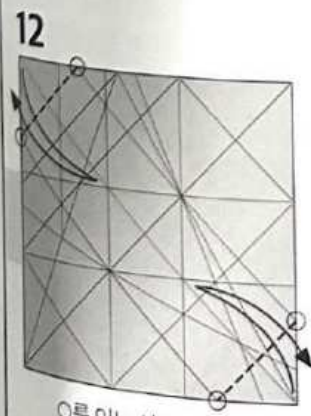

○를 잇는 선으로 접었다 편 선을 내주세요.

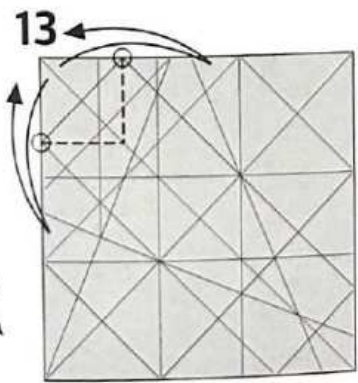

○ 부분에서 접었다 편 선을 내주세요.

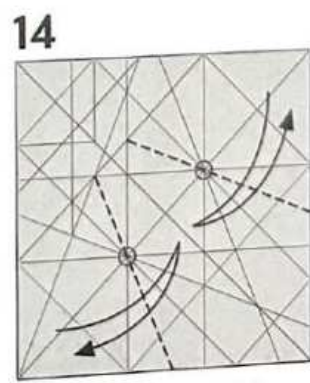

○ 부분에서 접었다 편 선을 내주세요.

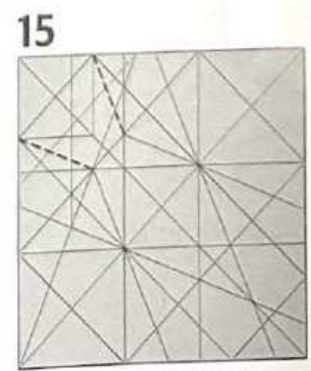

22.5도 선을 내주세요.

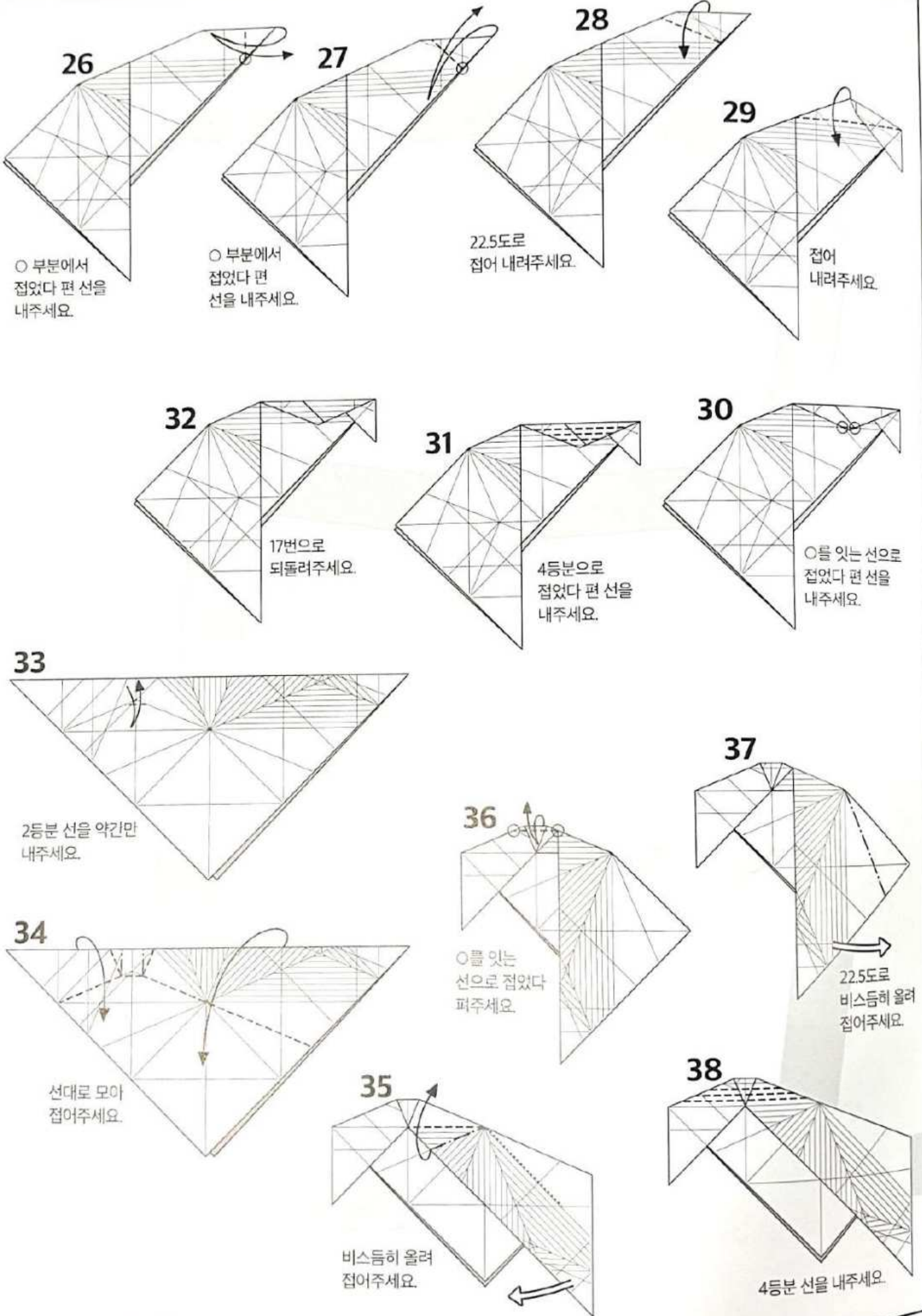



46

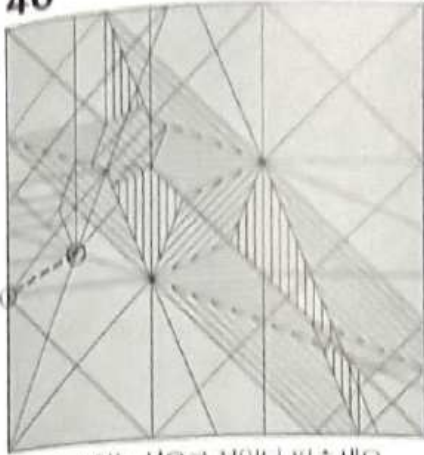

○를 잇는 선으로 접었다 펴주세요.

48

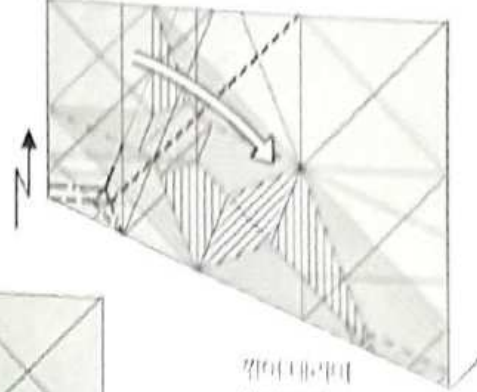

꺾어 대각선에  
접어주세요

47



뒤로 접어주세요.

45



○를 잇는 선으로 접었다 펴주세요.

43

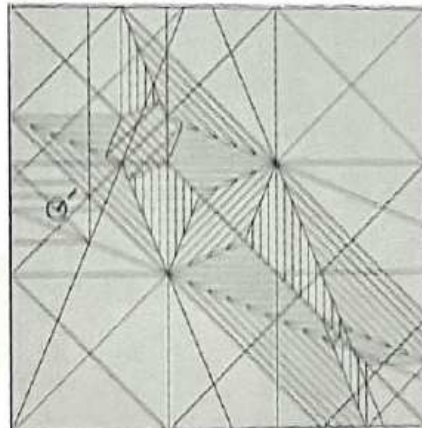

○ 부분에서 45도 선을 내주세요.

42

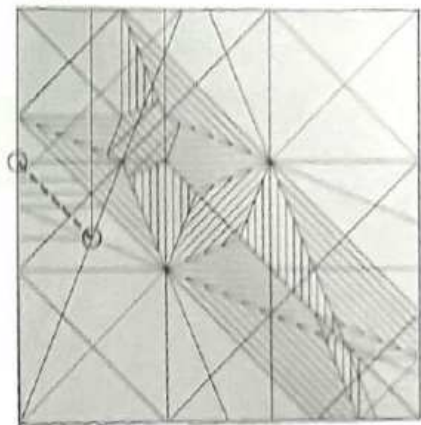

○를 잇는 선으로 접었다 펴주세요.

44



○를 잇는 선으로 접었다 펴주세요.

41



2등분 선을 내주세요.

39

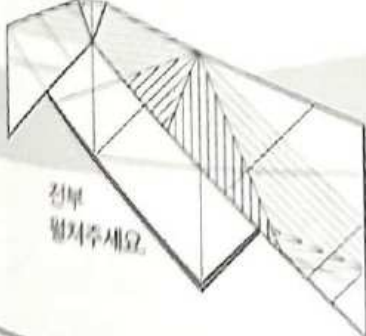

전부  
펼쳐주세요.

40

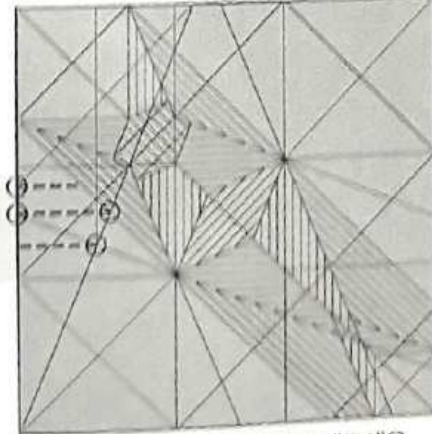

○ 부분에서 접었다 펴 선을 내주세요.

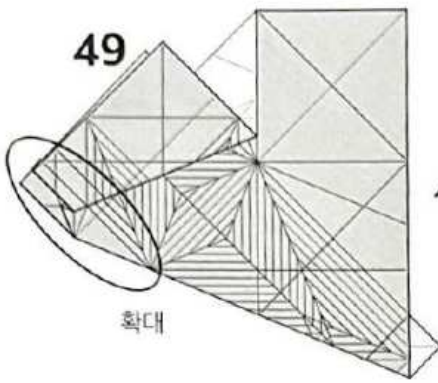

49

확대

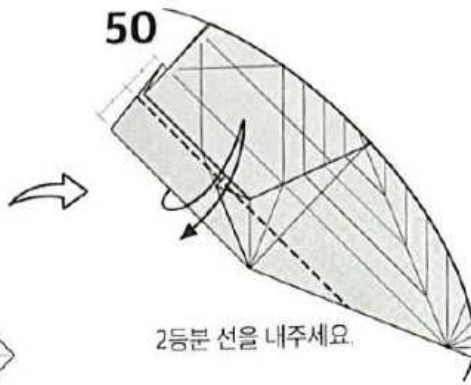

50

2등분 선을 내주세요.



51

4등분 선을 내주세요.

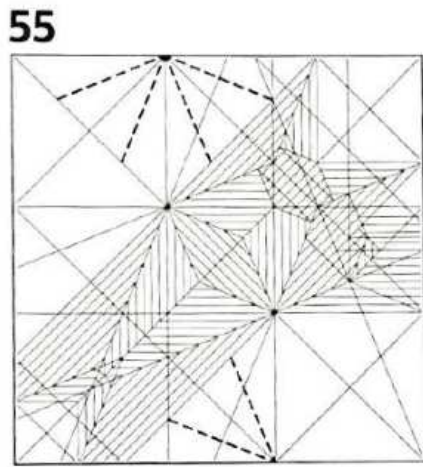

55

선에 맞춰 22.5도 선을 내주세요.

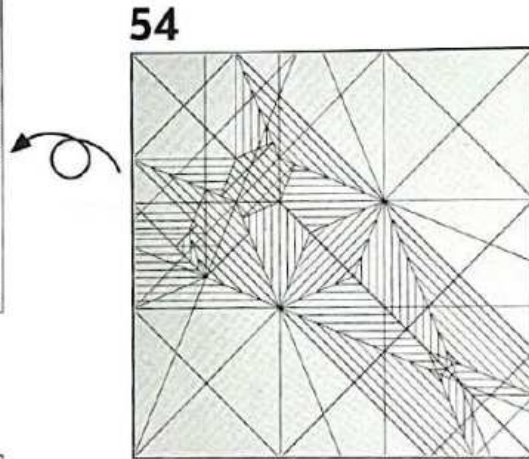

54

뒤집어주세요.

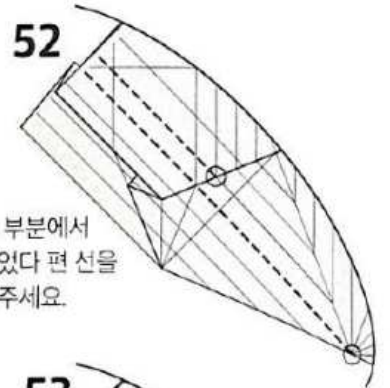

52

○ 부분에서  
접었다 편 선을  
내주세요.

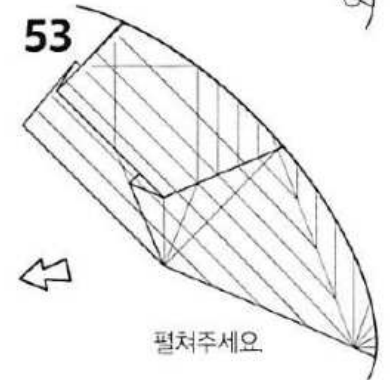

53

펼쳐주세요

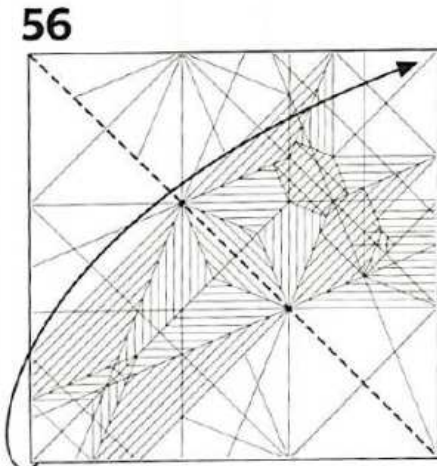

56

반으로 접어주세요.

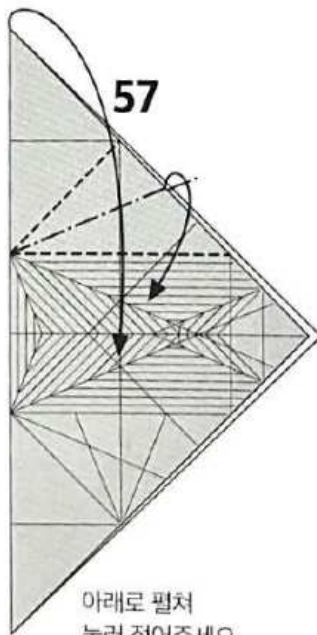

57

아래로 펼쳐  
눌러 접어주세요.

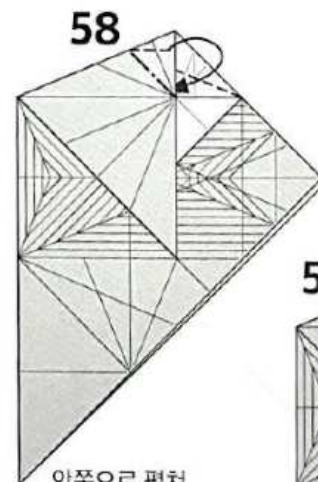

58

안쪽으로 펼쳐  
눌러 접어주세요.

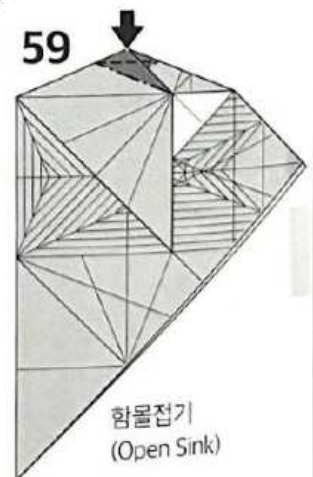

59

함몰접기  
(Open Sink)



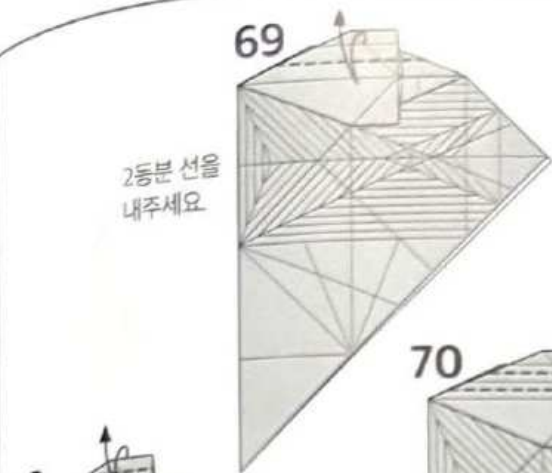

2등분 선을  
내주세요



69



70

4등분 선을  
내주세요.

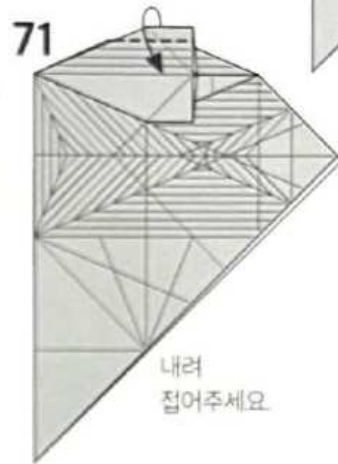

71

내려  
접어주세요.



72

○부분에서 접었다  
편 선을 내주세요.



67

밖으로 펼쳐  
눌러 접어주세요.

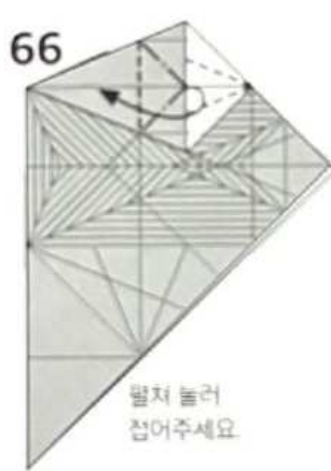

66

펼쳐 눌러  
접어주세요.

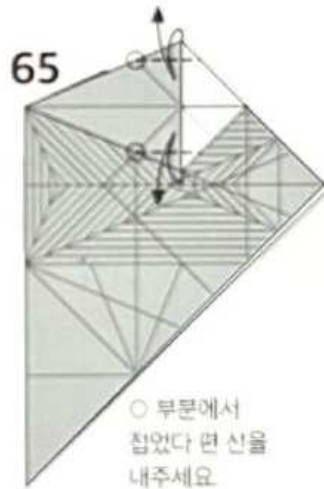

65

○부분에서  
접었다 편 선을  
내주세요.



64

2장 위로  
올립니다.



60

2등분 선을  
내주세요.



61

4등분 선을  
내주세요.



62

안쪽으로 펼쳐  
눌러 접어주세요.

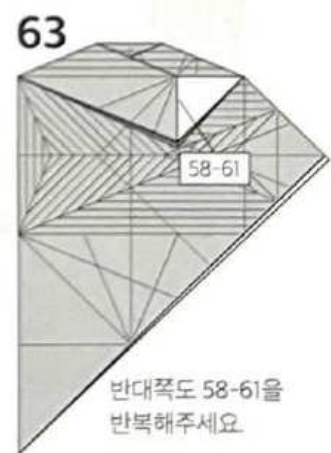

63

반대쪽도 58-61을  
반복해주세요.

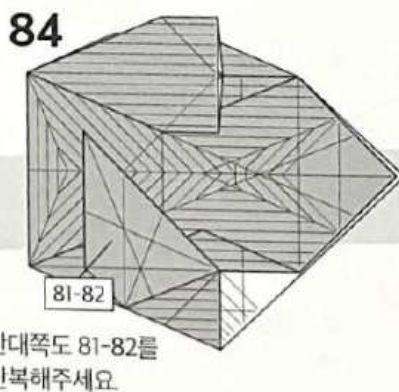
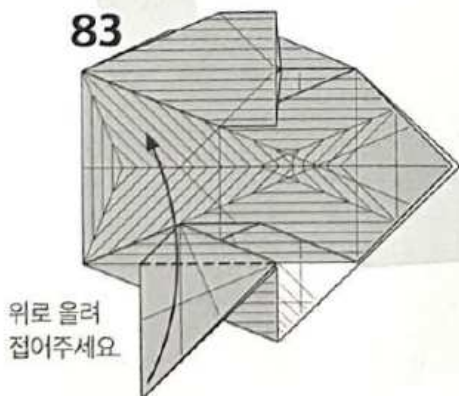
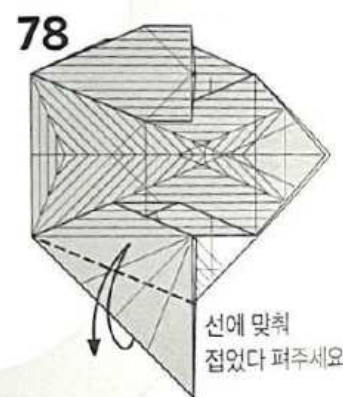
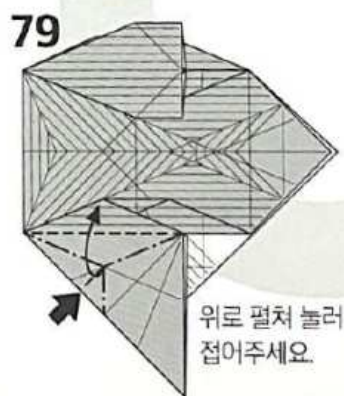
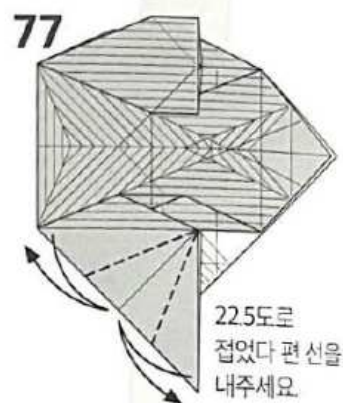
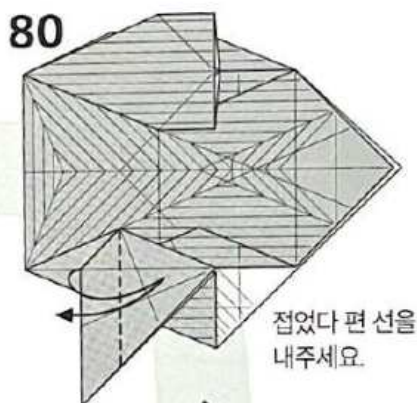
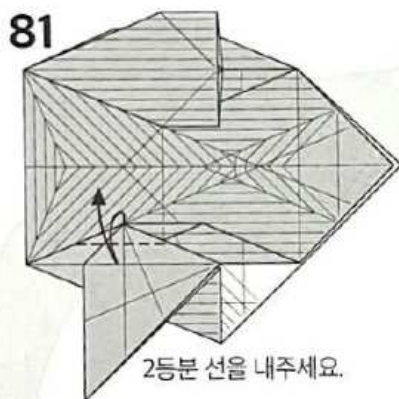
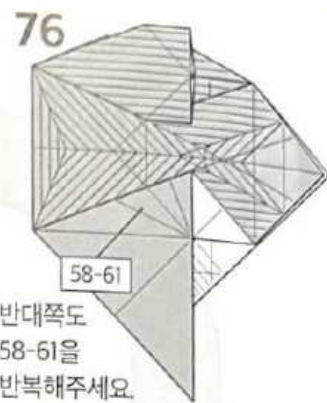
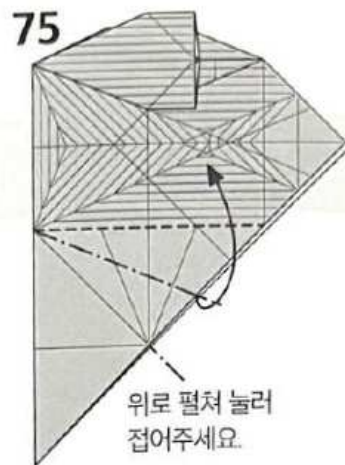
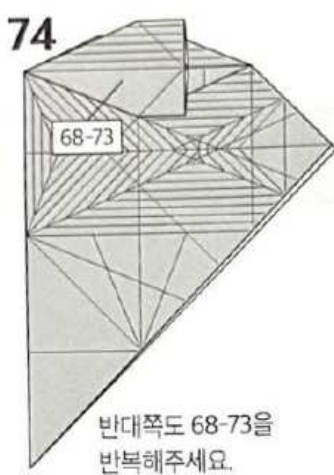



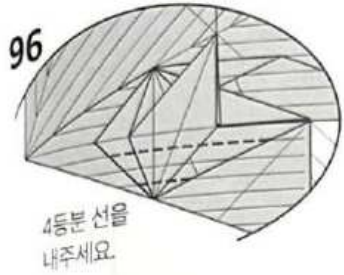

96

4등분 선을  
내주세요.

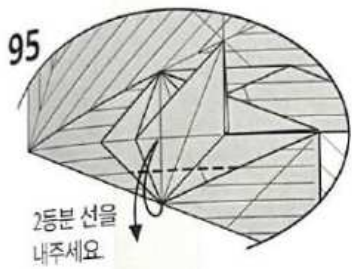

95

2등분 선을  
내주세요.

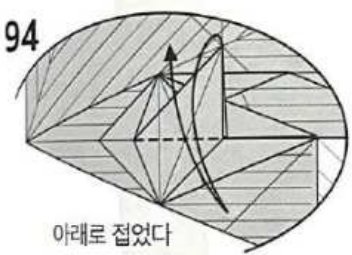

94

아래로 접었다  
펴주세요.

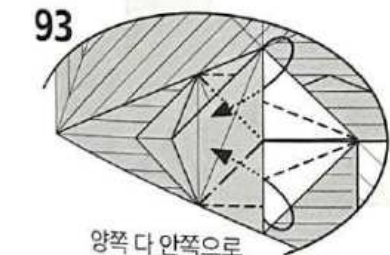

93

양쪽 다 안쪽으로  
접어 넣주세요.

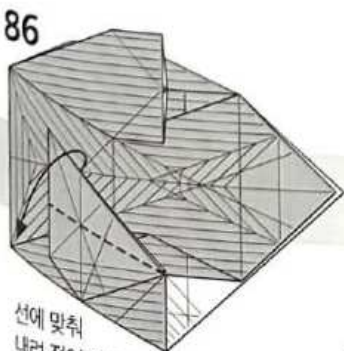

86

선에 맞춰  
내려 접어주세요.

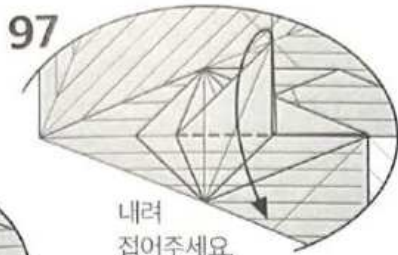

97

내려  
접어주세요.

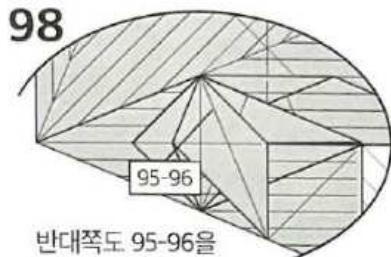

98

반대쪽도 95-96을  
반복해주세요.

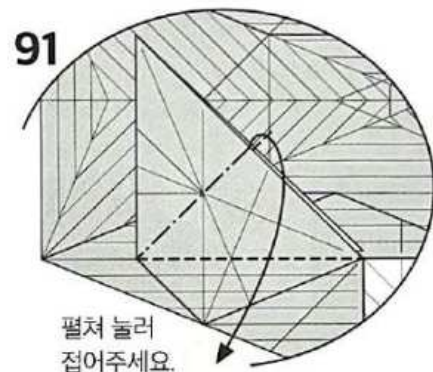

91

펼쳐 눌러  
접어주세요.

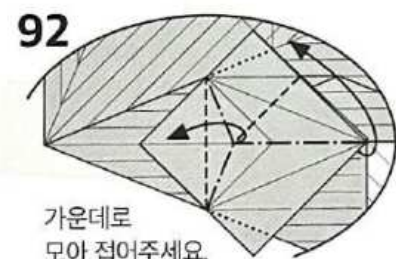

92

가운데로  
모아 접어주세요.

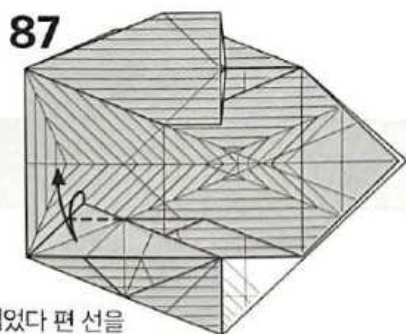

87

접었다 편 선을  
내주세요.

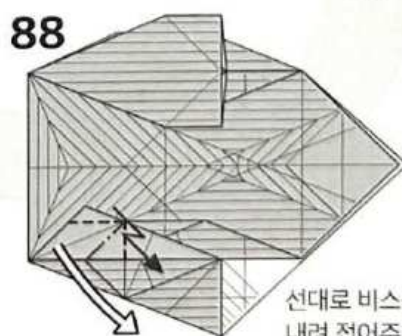

88

선대로 비스듬히  
내려 접어주세요.

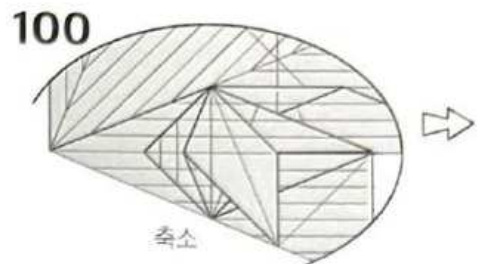

100

축소

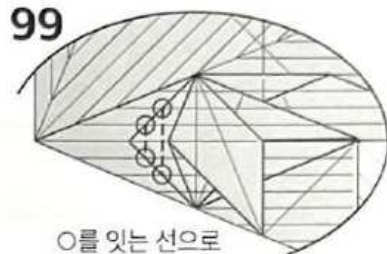

99

○를 잇는 선으로  
접었다 펴주세요.

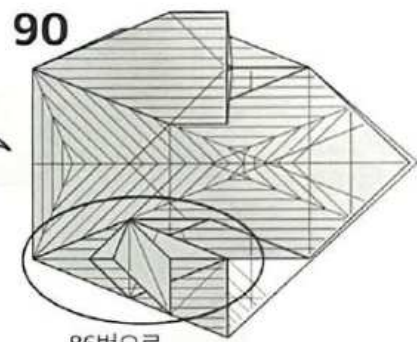

90

86번으로  
돌아가주세요.

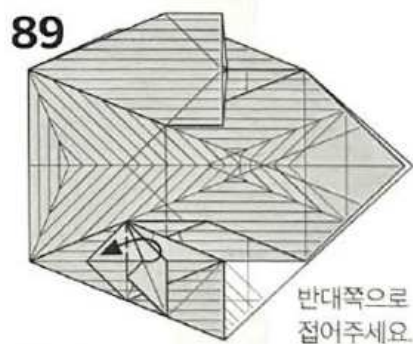

89

반대쪽으로  
접어주세요.



101

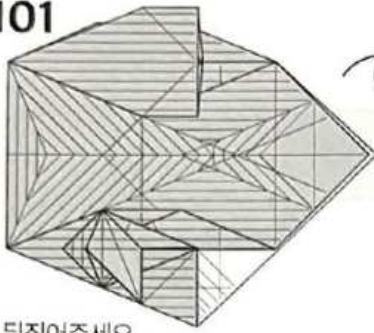

뒤집어주세요.

102

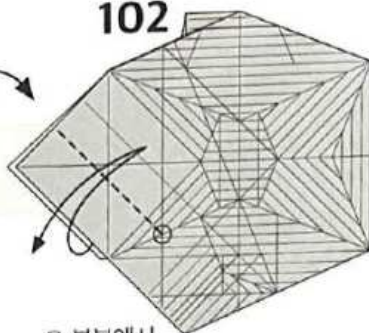

○ 부분에서  
접었다 편 선을 내주세요.

103

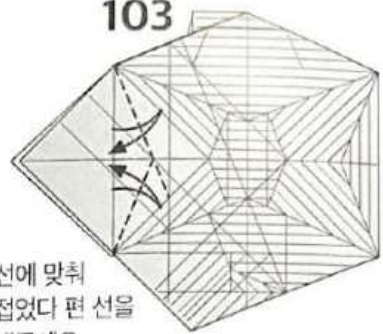

선에 맞춰  
접었다 편 선을  
내주세요.

104

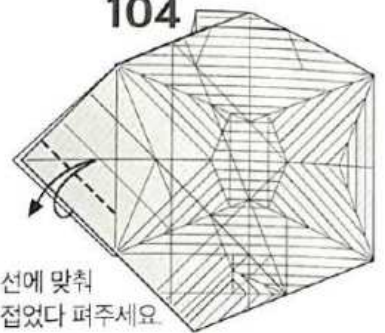

선에 맞춰  
접었다 퍼주세요.

108

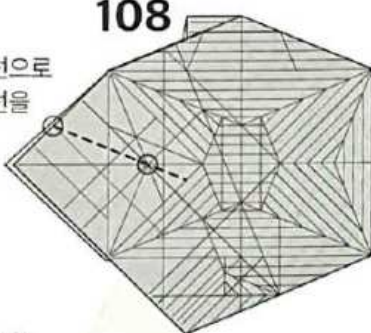

○를 잇는 선으로  
접었다 편 선을  
내주세요.

107

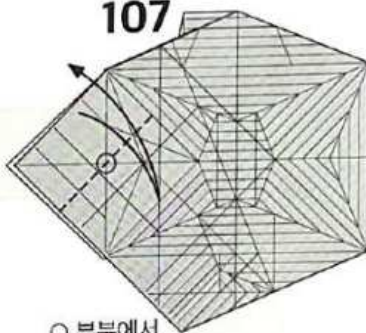

○ 부분에서  
접었다 편 선을 내주세요.

105

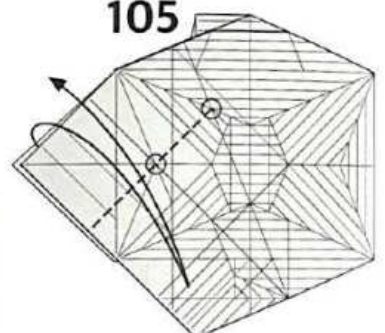

○를 잇는 선으로  
접었다 편 선을 내주세요.

109

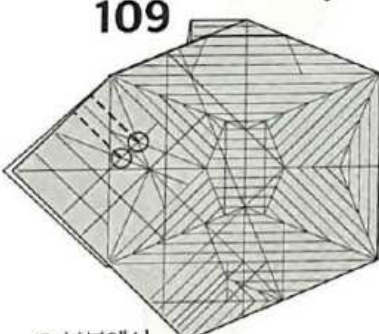

○ 부분에서  
접었다 편 선을 내주세요.

106

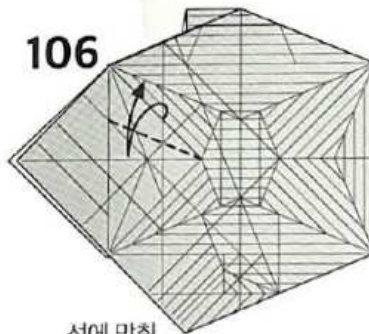

선에 맞춰  
22.5도 선을 내주세요.

110

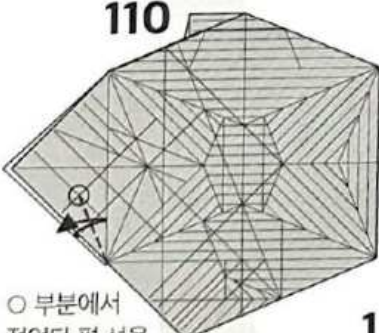

○ 부분에서  
접었다 편 선을  
내주세요.

112

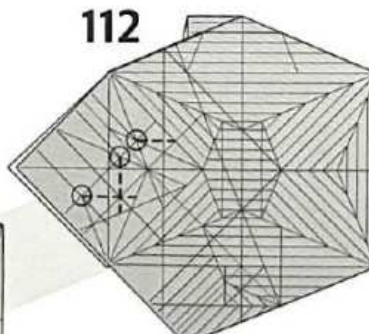

○ 부분에서 접었다 편  
선을 내주세요.

113

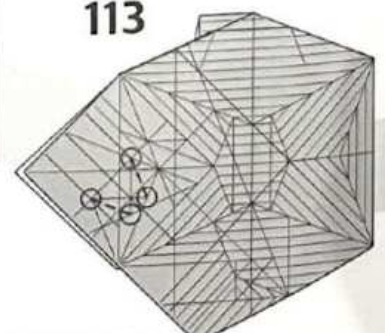

○를 잇는 선으로  
접었다 편 선을 내주세요.

111



○를 잇는 선으로  
접었다 편 선을 내주세요.



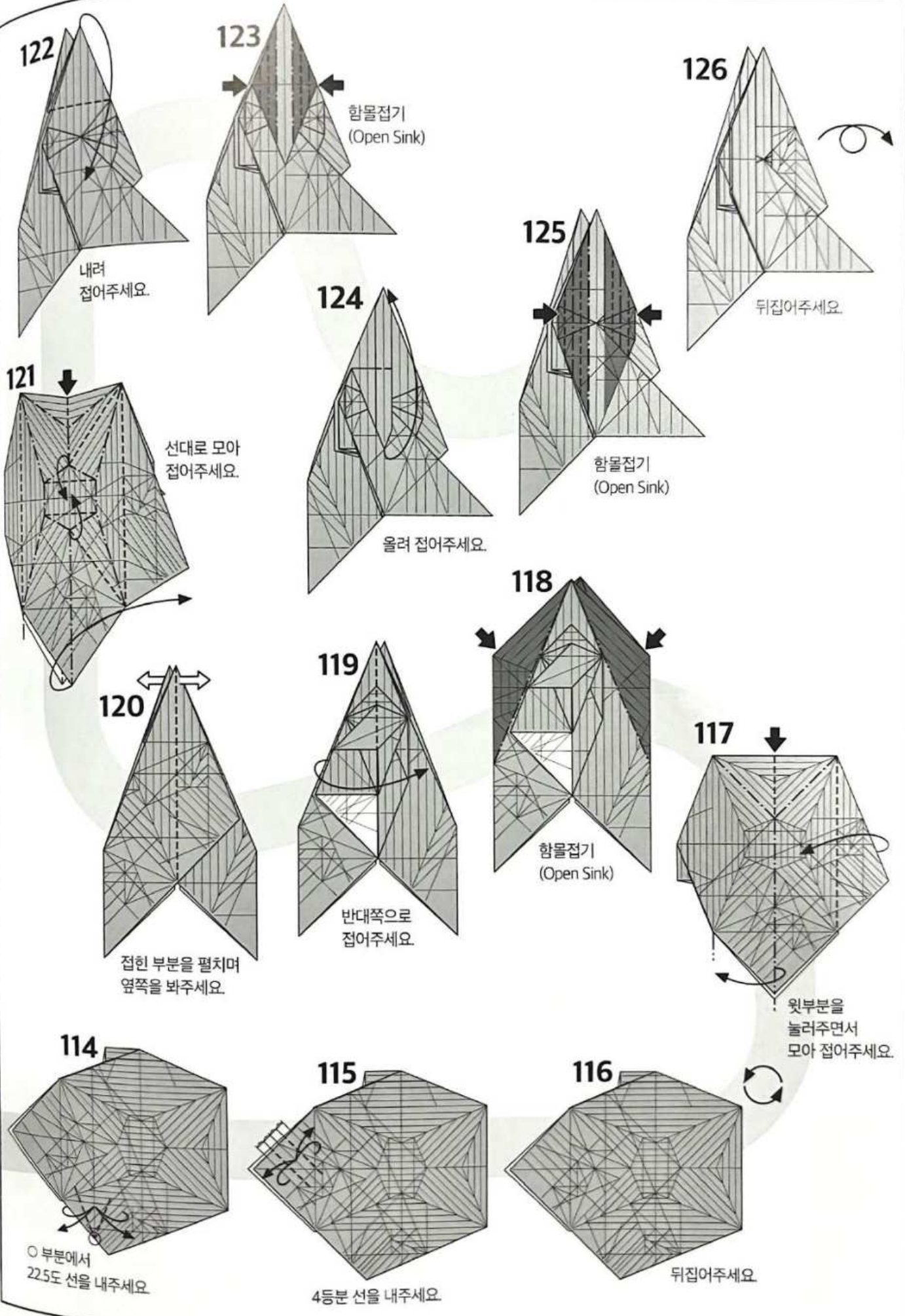

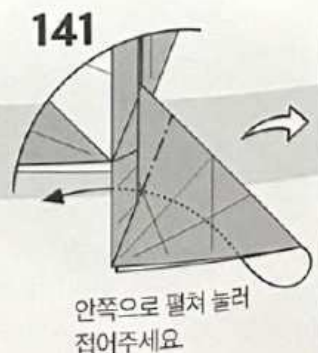
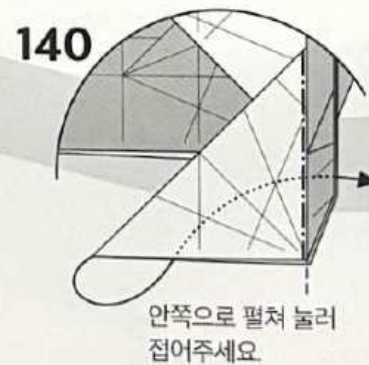
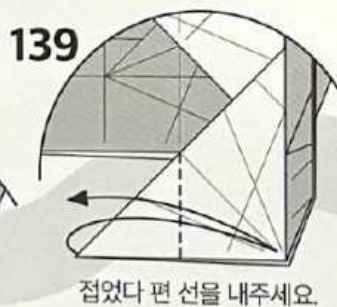
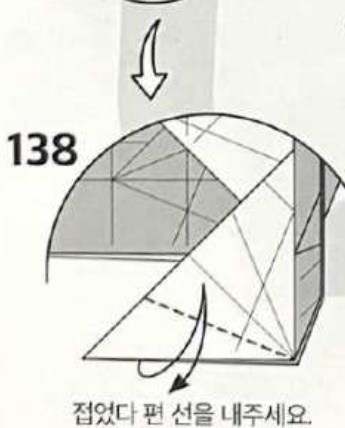
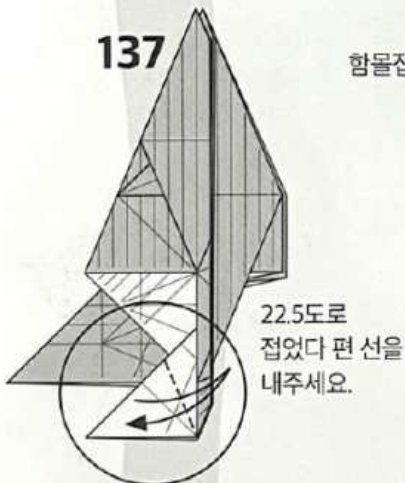
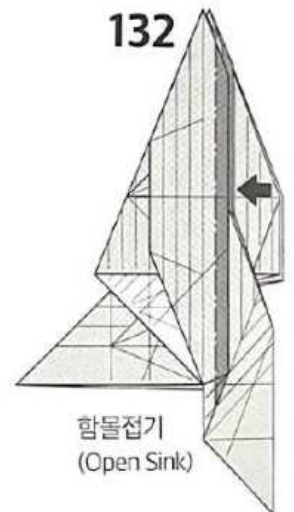
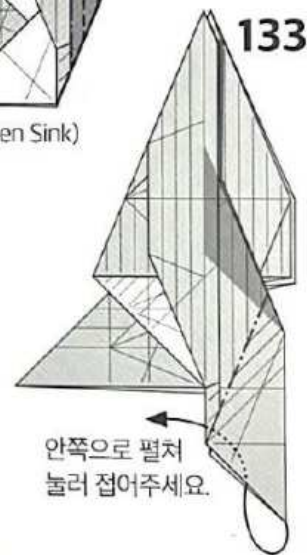
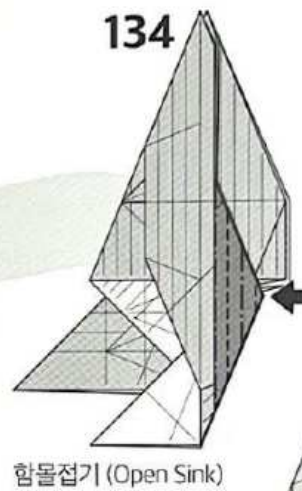
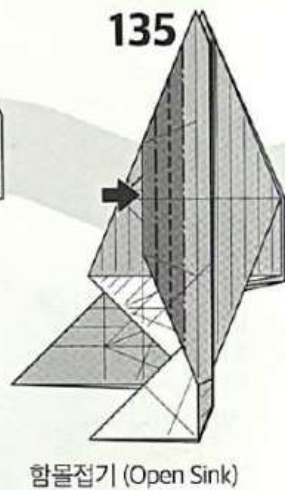
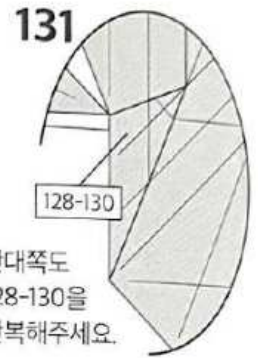
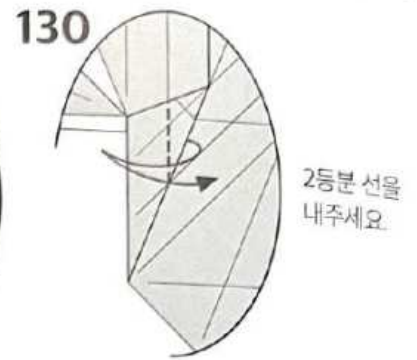
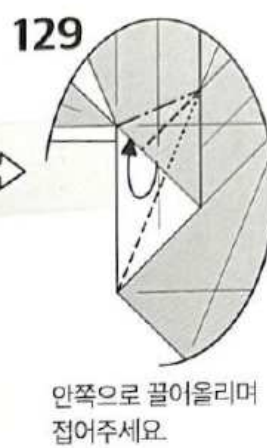
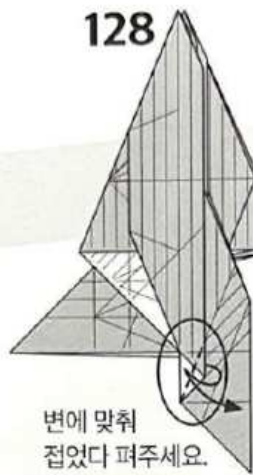
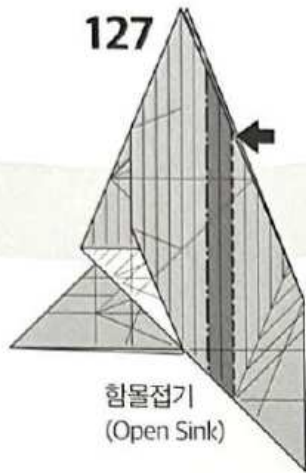



154

함몰접기 (Open Sink)

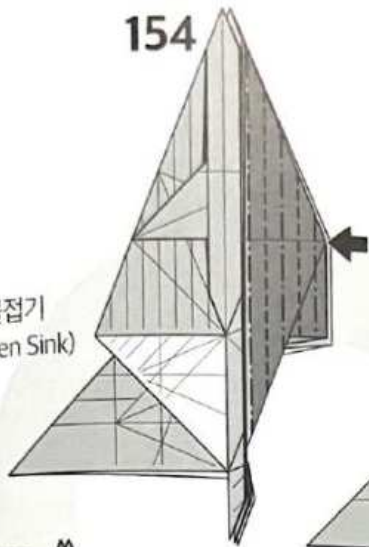

155

함몰접기 (Open Sink)

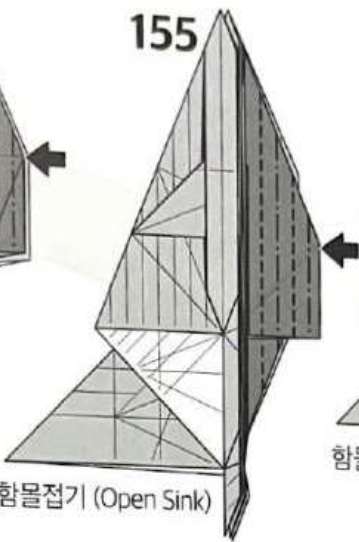

156

함몰접기 (Open Sink)

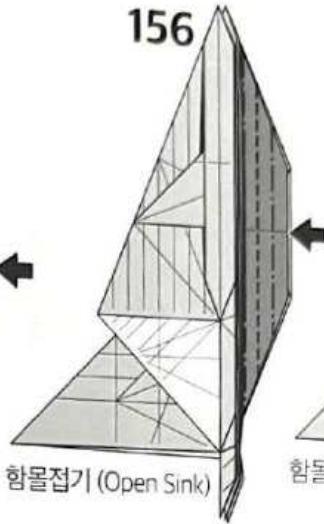

157

함몰접기 (Open Sink)

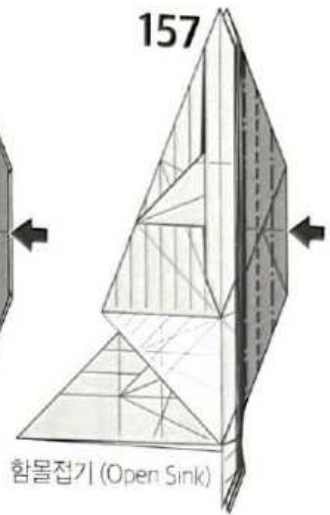

153

151-152

반대쪽도  
151-152를  
반복해주세요.

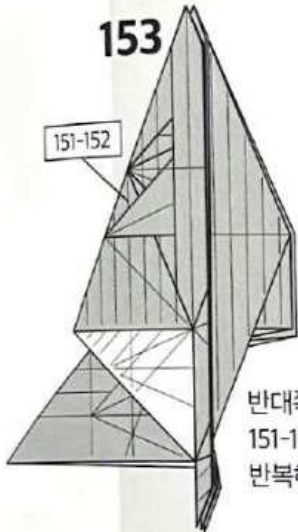

148

함몰접기 (Open Sink)

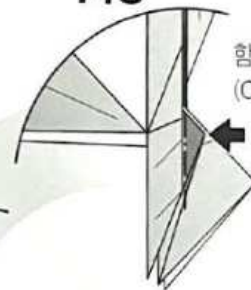

149

반대쪽도  
147-148을  
반복해주세요.

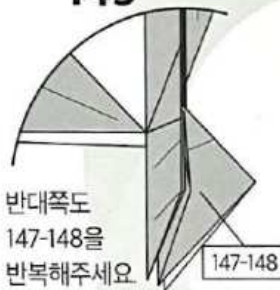

147

안쪽으로  
접어  
넣어주세요.



152

함몰접기 (Open Sink)

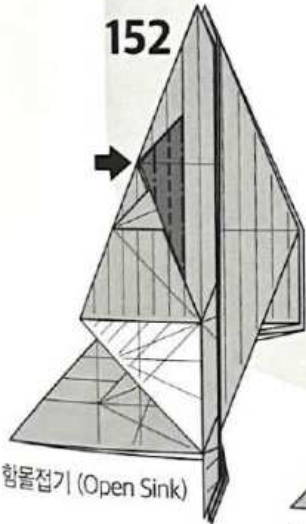

151

함몰접기 (Open Sink)

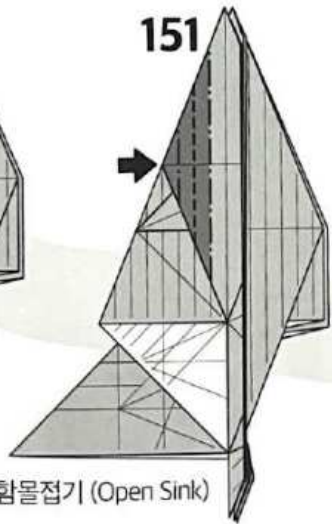

150

축소



146

안쪽으로  
계단접기  
해주세요.

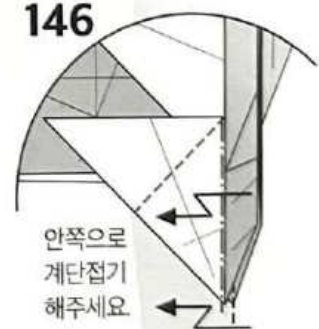

142

반대쪽으로  
접어주세요.



143

접었다 편 선을  
내주세요.

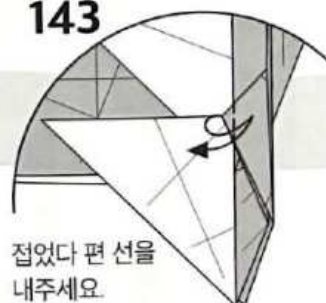

144

다시  
펼쳐주세요.



145

함몰접기 (Open Sink)



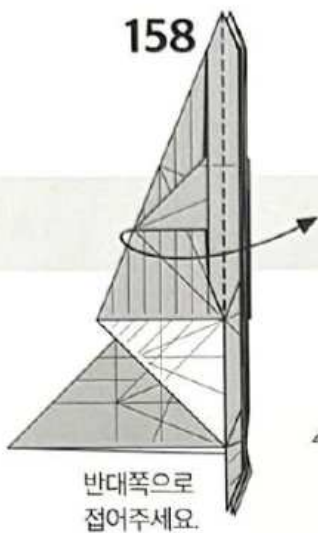

158  
반대쪽으로  
접어주세요.

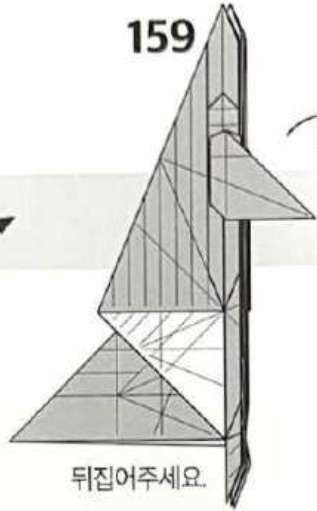

159  
뒤집어주세요.

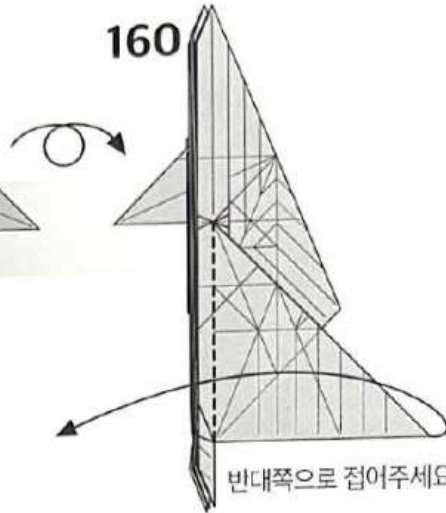

160  
반대쪽으로  
접어주세요.

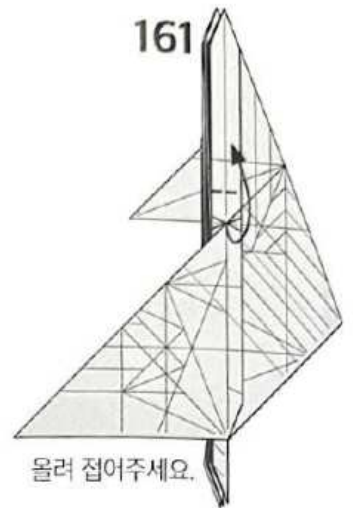

161  
올려  
접어주세요.

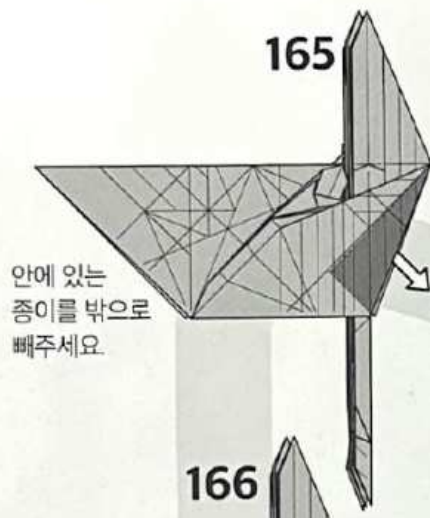

162  
안에 있는  
종이를 밖으로  
빼주세요.

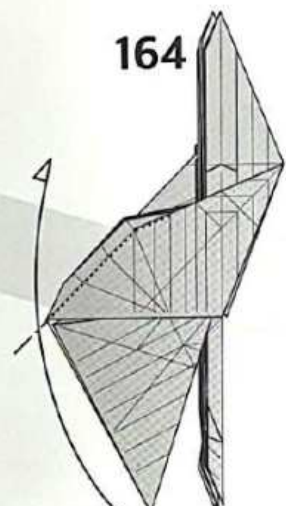

163  
올려  
접어주세요.

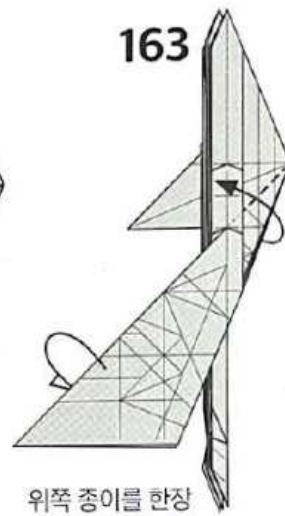

164  
위쪽 종이를 한장  
잡고 아래 종이를  
뒤집어주세요.

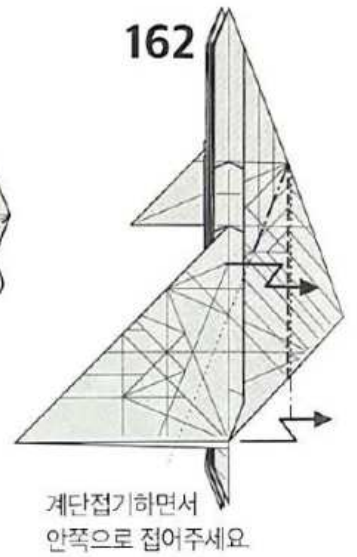

165  
계단접기하면서  
안쪽으로  
접어주세요.



166  
계단접기하면서  
반대쪽으로  
접어주세요.

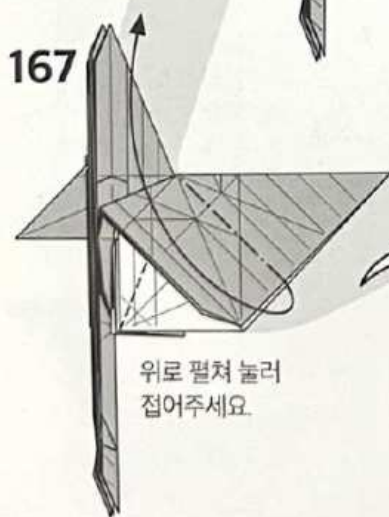

167  
위로 펼쳐 눌러  
접어주세요.

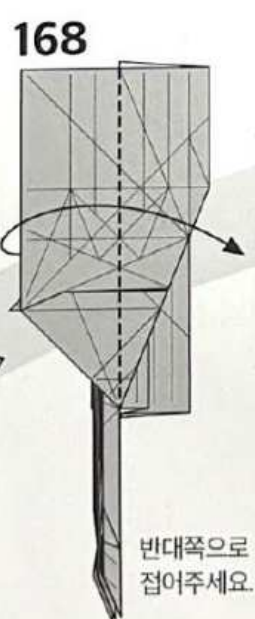

168  
반대쪽으로  
접어주세요.

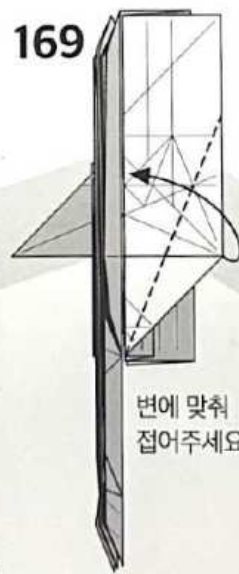

169  
변에 맞춰  
접어주세요.

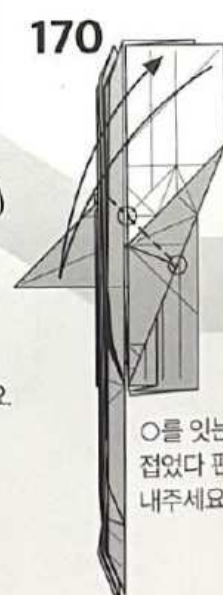

170  
O를 잇는 선으로  
접었다 편 선을  
내주세요.

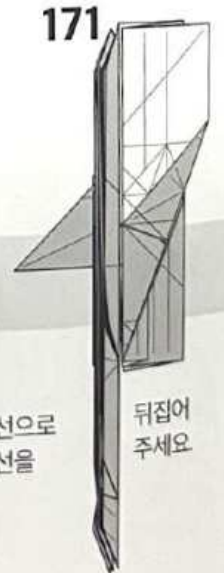

171  
뒤집어  
주세요.



182

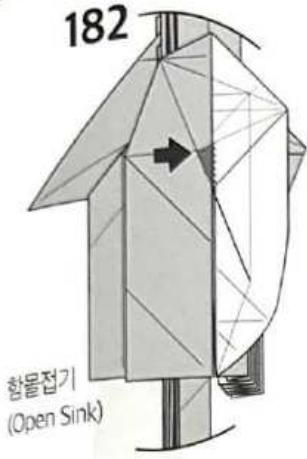

함몰접기  
(Open Sink)

183

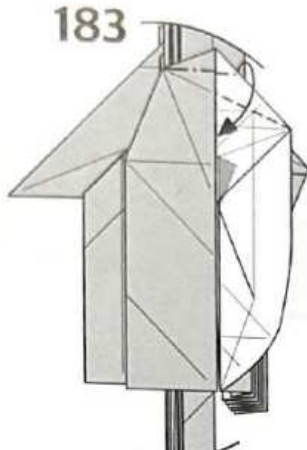

안쪽으로 접어주세요

184

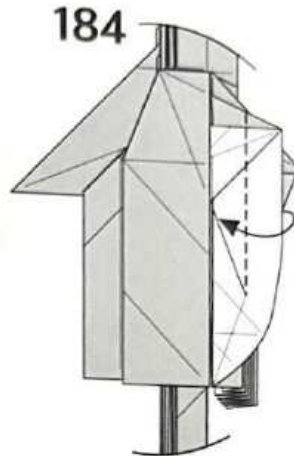

펼친 부분을 다시 접어주세요

185

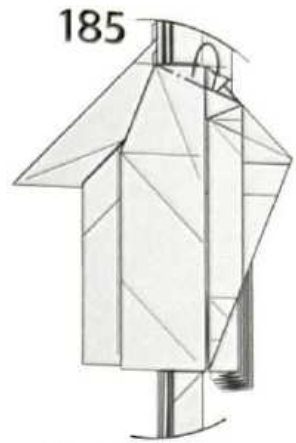

뒤로 접어서 벌어지지 않게  
잠궜주세요

181

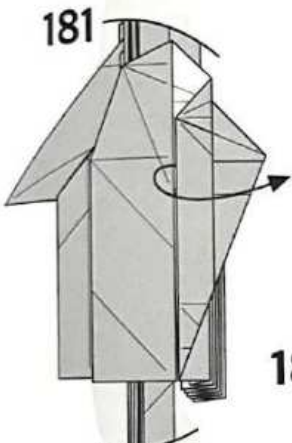

한장 펼쳐주세요

180

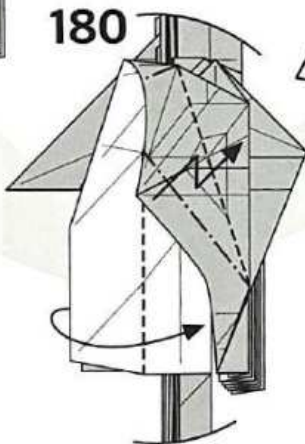

계단접기 해주세요

179

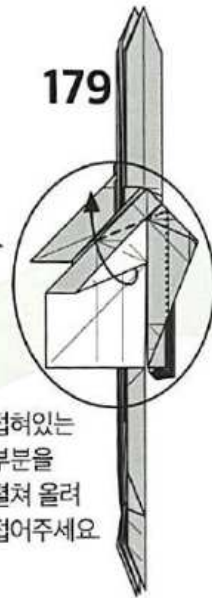

접혀있는  
부분을  
펼쳐 올려  
접어주세요

178

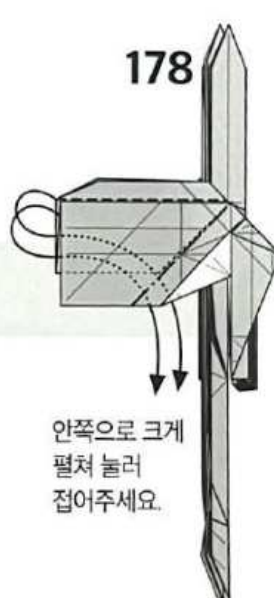

안쪽으로 크게  
펼쳐 눌러  
접어주세요

177



다시  
펼쳐주세요

172

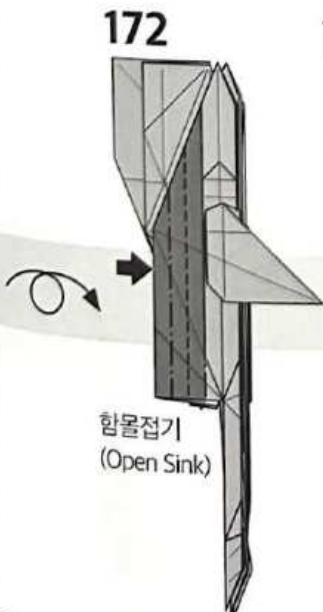

함몰접기  
(Open Sink)

173

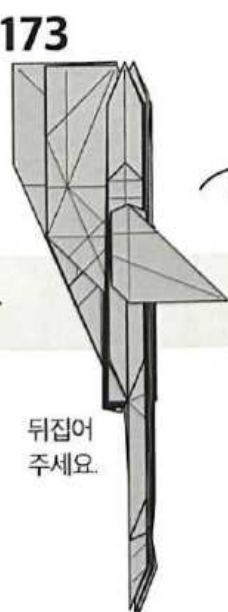

뒤집어  
주세요

174

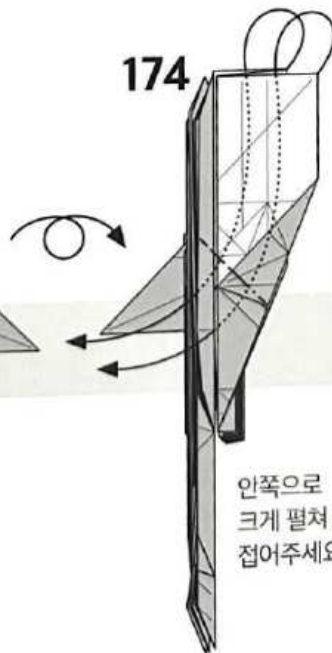

안쪽으로  
크게 펼쳐 눌러  
접어주세요

175



반대쪽으로  
접어주세요

176



접었다면  
선을 내주세요



186 반대쪽도 175-177을 반복해주세요.

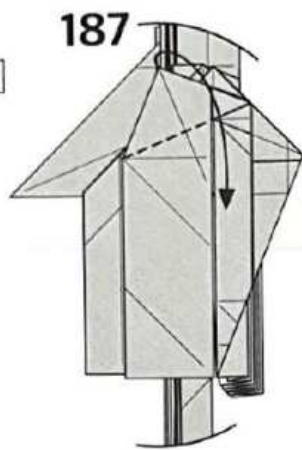

187 내려 접어주세요.

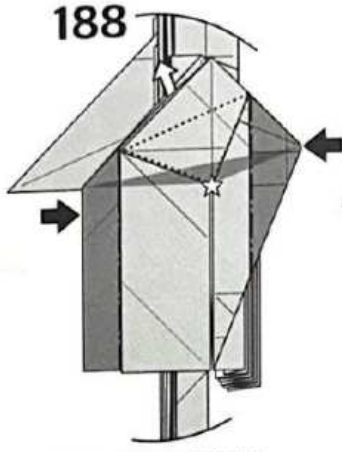

188 양쪽을 함몰접기하면서 내부의 ☆부분을 밖으로 빼주세요.

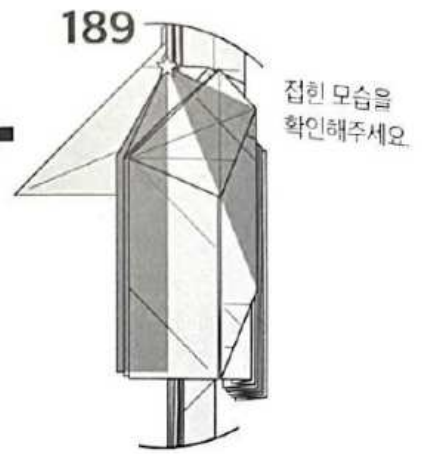

189 접힌 모습을 확인해주세요.



194 가장 바깥쪽의 한장을 펼쳐주세요.

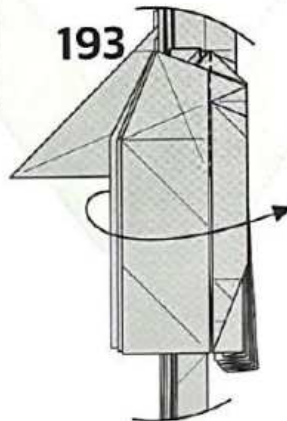

193 반대쪽으로 접어주세요.

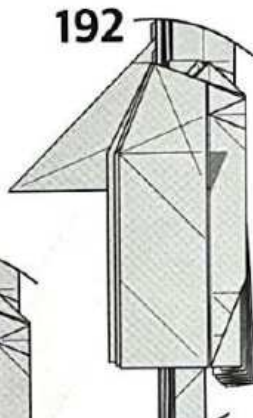

192 접힌 모습을 확인해주세요.

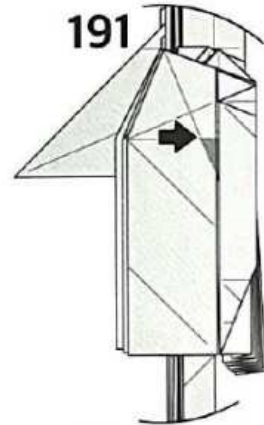

191 함몰접기 (Open Sink)

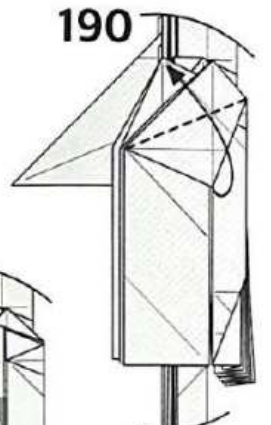

190 올려 접어주세요.

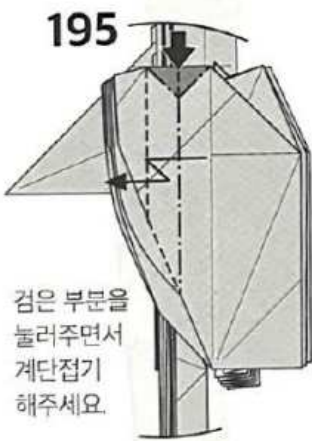

195 검은 부분을 눌러주면서 계단접기 해주세요.

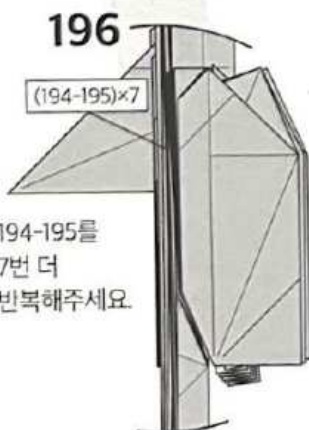

196 (194-195)×7  
194-195를 7번 더 반복해주세요.



197 반대쪽으로 접어주세요.

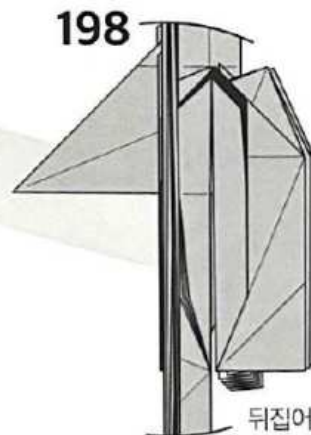

198 뒤집어주세요.

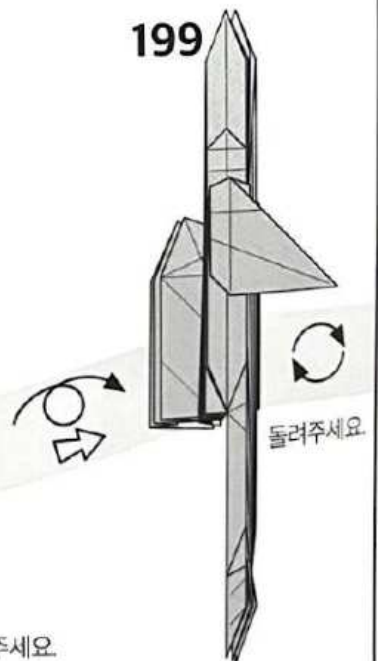

199 돌려주세요.



209

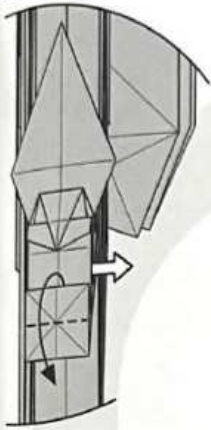

접혀있는 부분을  
펼쳐주세요.

210

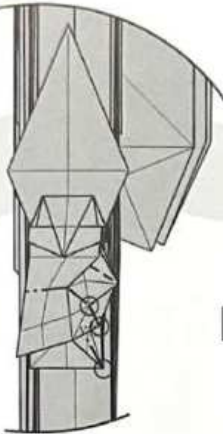

○를 잇는 선으로  
이어 접어주세요.

211

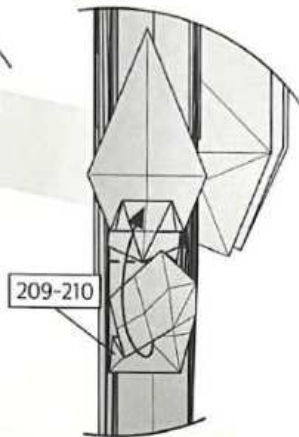

접어 올리면서 반대쪽도  
209-210을 반복해주세요.

212

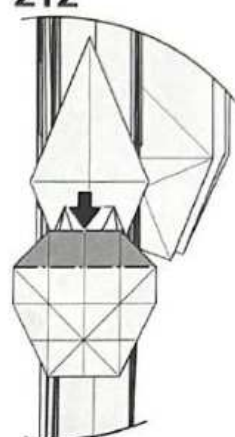

함몰접기 (Closed Sink)

213

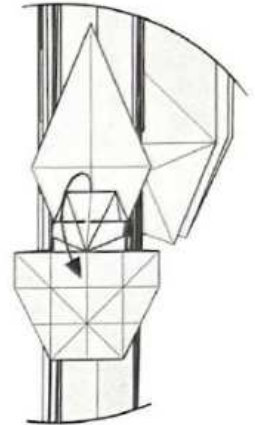

내려 접어주세요.

208

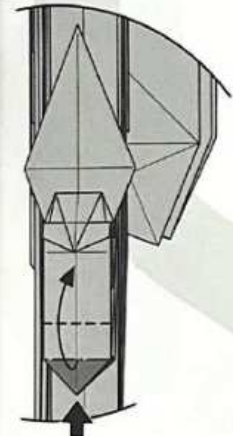

함몰접기하면서  
1칸 올려주세요.

207

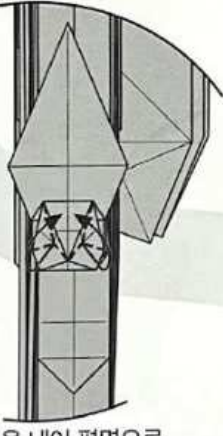

선을 내어 평면으로  
접어주세요.

206

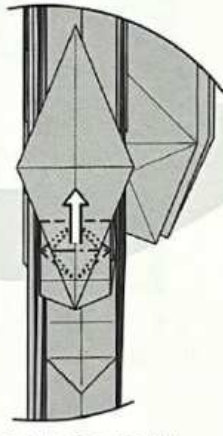

접힌 부분을 펼치면서  
끌어 올려주세요.

205

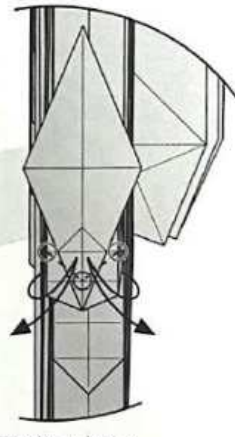

○를 잇는 선으로  
접었다 편 선을 내주세요.

204

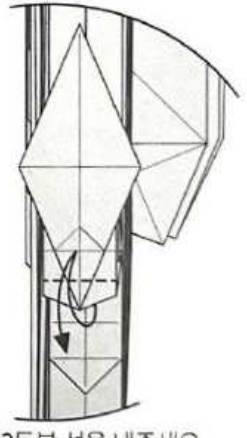

2등분 선을 내주세요.

200

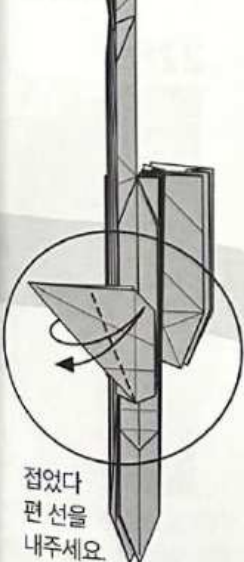

접었다  
편 선을  
내주세요.

201

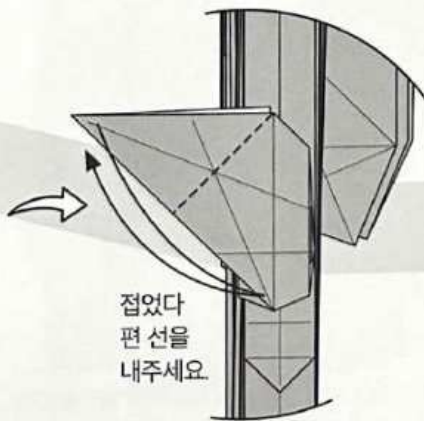

접었다  
편 선을  
내주세요.

202

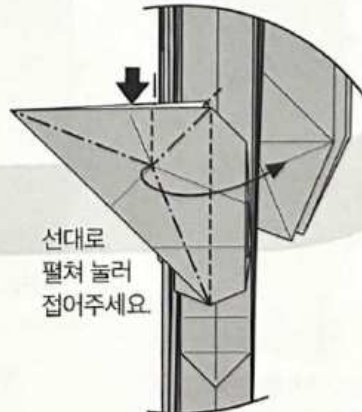

선대로  
펼쳐 눌러  
접어주세요.

203

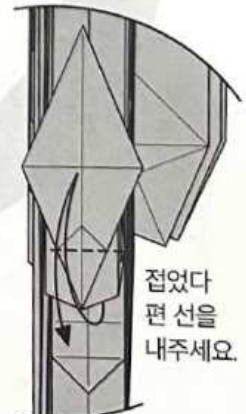

접었다  
편 선을  
내주세요.

214

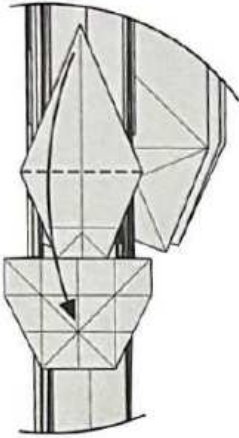

내려 접어주세요.

215

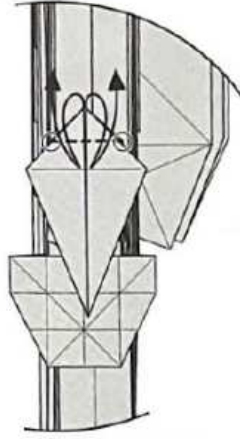

○ 부분에서 접었다 편 선을 내주세요.

216

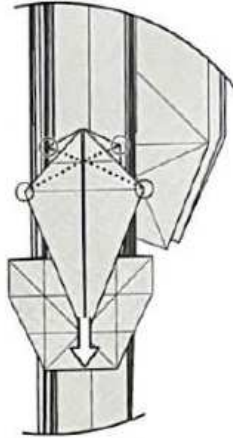

○를 잇는 선으로 펼쳐 눌러 접어주세요.

217

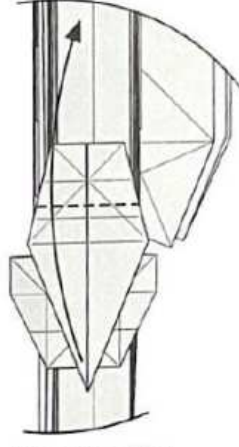

올려 접어주세요.

218

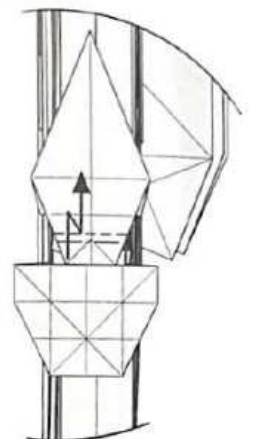

적당히 계단접기 해주세요.

223

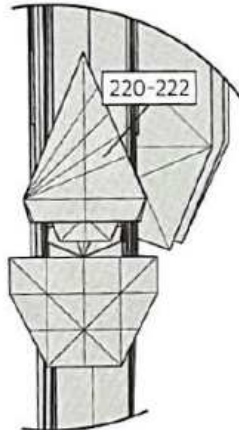

반대쪽도 220-222를 반복해주세요.

222

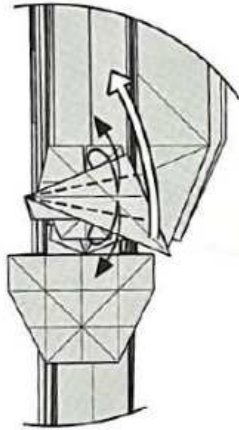

반의 각도로 접었다 펴주고 220번으로 돌아가주세요.

221

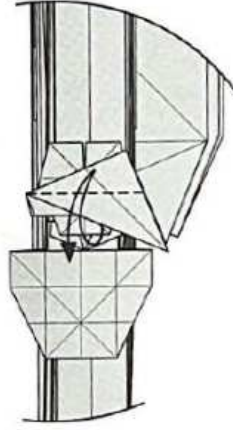

변에 맞춰 접었다 펴주세요.

220

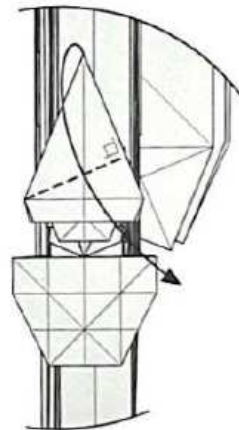

변과 90도가 되도록 접어주세요.

219

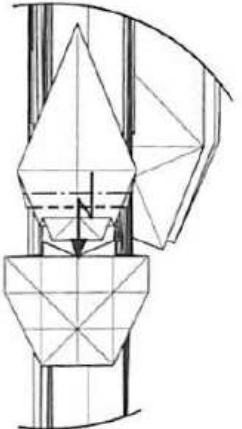

적당히 계단접기 해주세요.

224

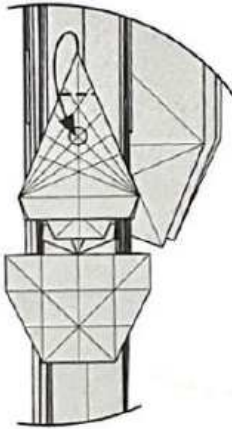

○에 맞추어 접어주세요.

225

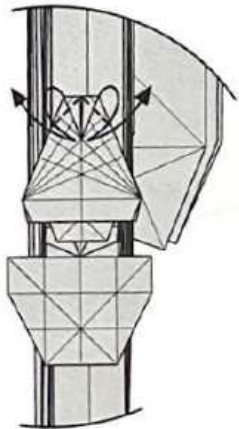

중심선에 맞추어 선을 내주세요.

226

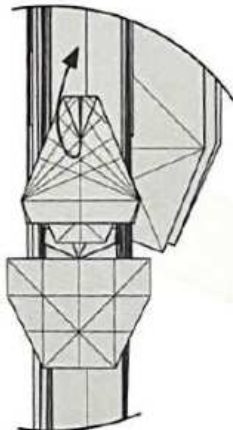

다시 펴주세요.

227

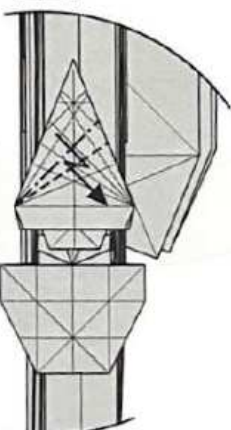

계단접기 해주세요.

228

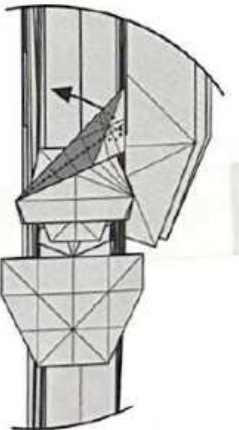

뒤에 종이를 앞으로 빼주세요.



239

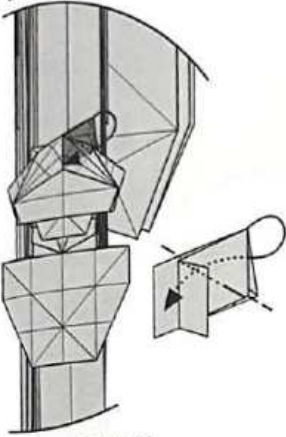

안쪽으로 펼쳐 눌러  
접어주세요.

240

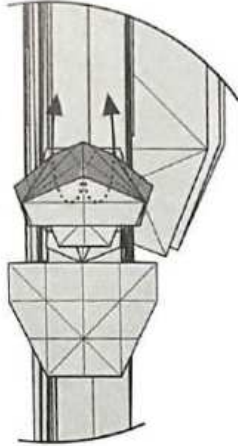

뒤에 있는 검은 부분을  
입체적으로 펼쳐주세요.

241

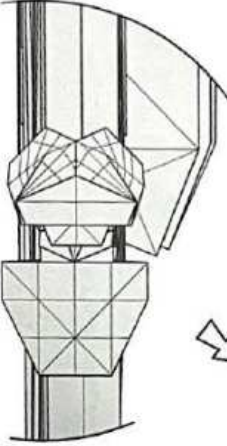

축소

242

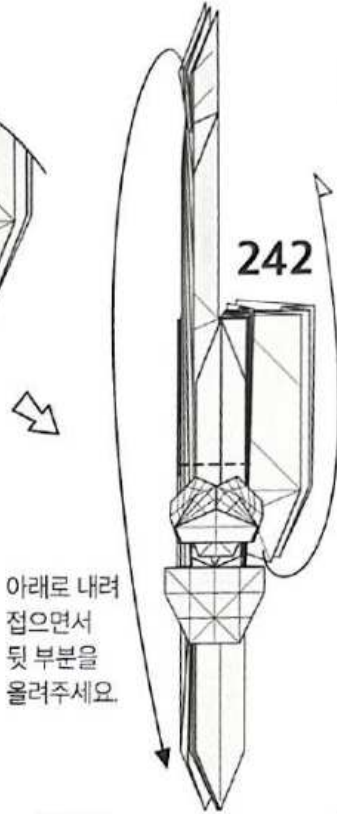

아래로 내려  
접으면서  
뒷 부분을  
올려주세요.

243

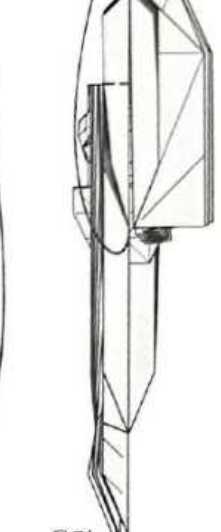

올려  
접어주세요.

238

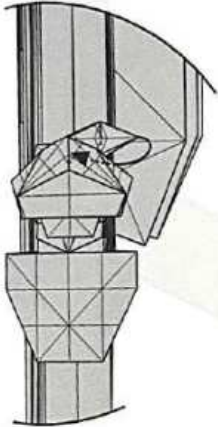

안쪽으로 접어  
넣어주세요.

237

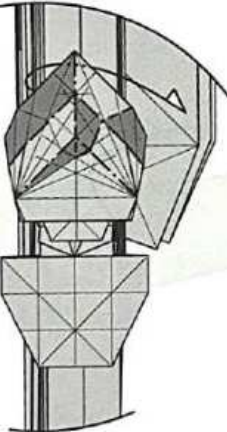

위의 각을 뒤로 넘기며  
선대로 접어주세요.

236

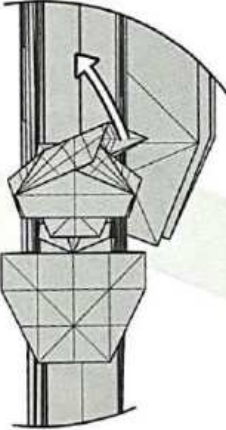

위로 잡아당기며  
펼쳐주세요.

235

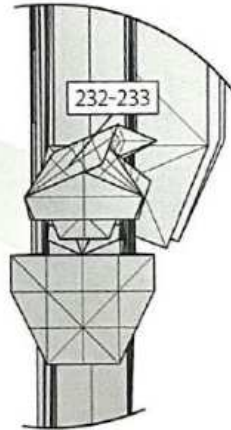

반대쪽도 232-233을  
반복해주세요.

234

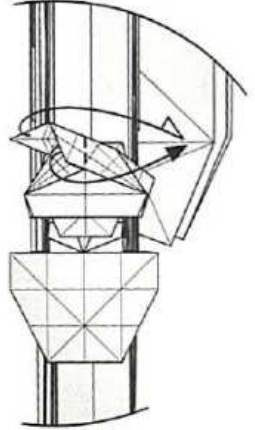

뒤집으면서 반대쪽으로  
접어주세요.

229

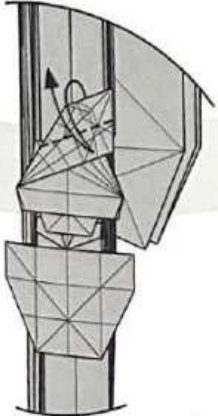

2등분 선을 내주세요.

230

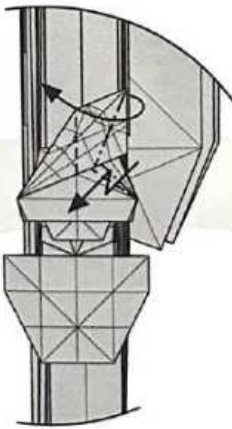

반대쪽으로 넘기며  
계단접기 해주세요.

231

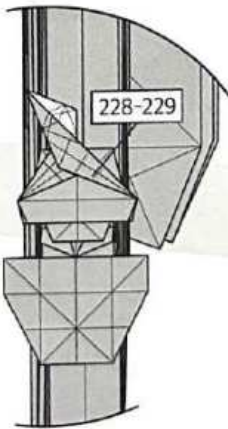

반대쪽도 228-229를  
반복해주세요.

232

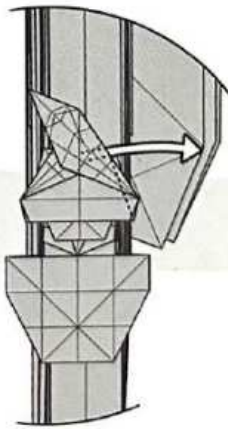

뒤에 있는 종이를  
펼쳐주세요.

233

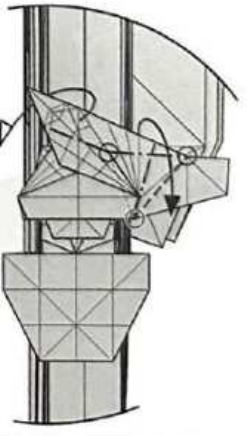

○를 잇는 선으로 모아  
접어주세요.

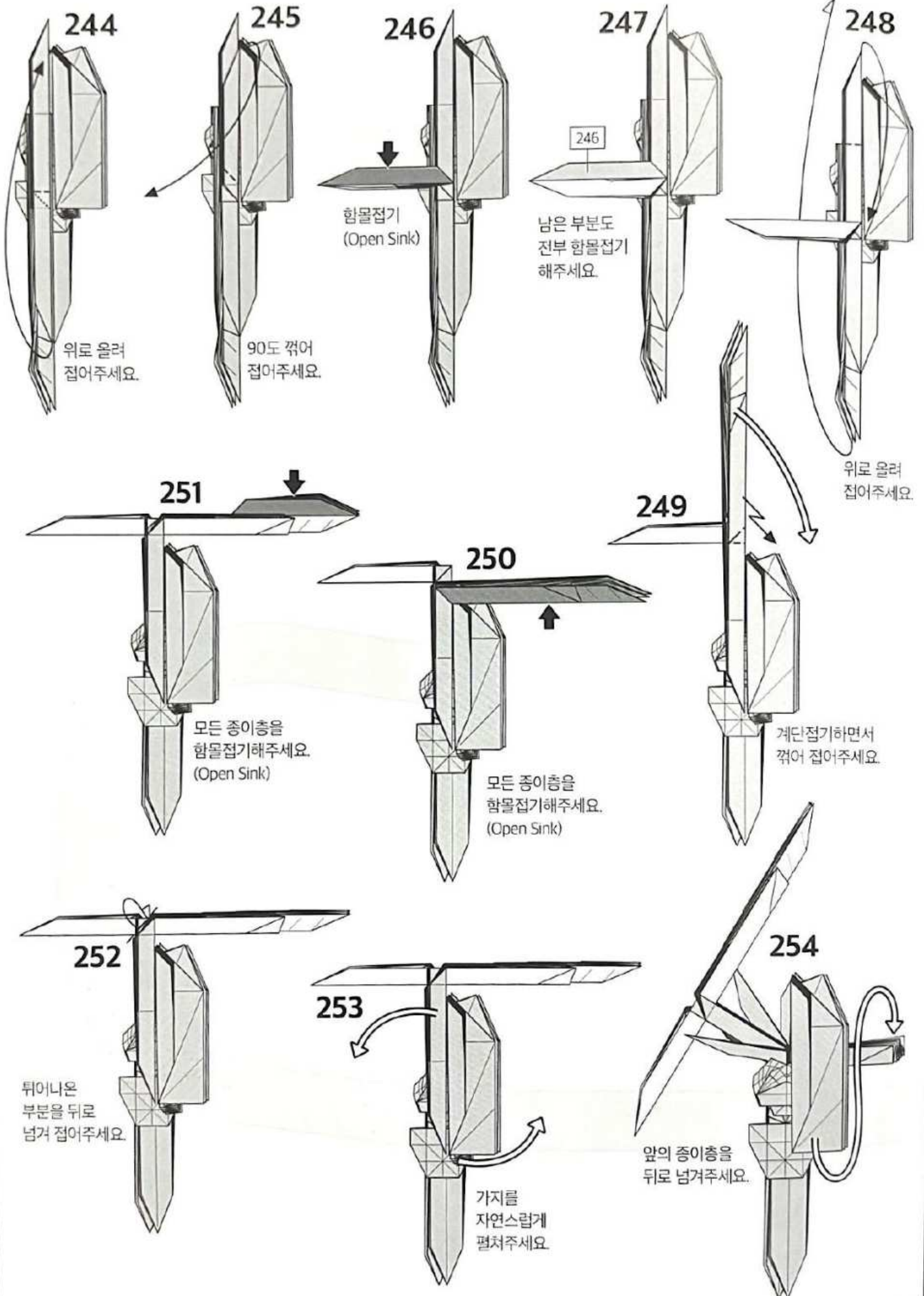



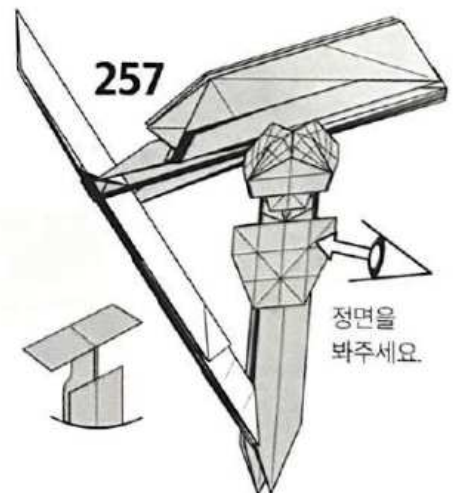
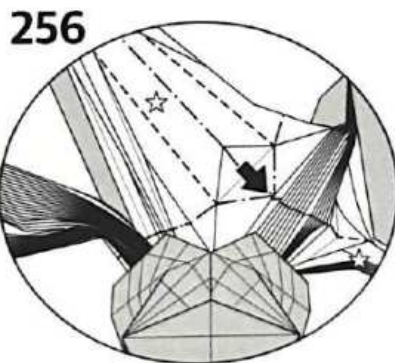
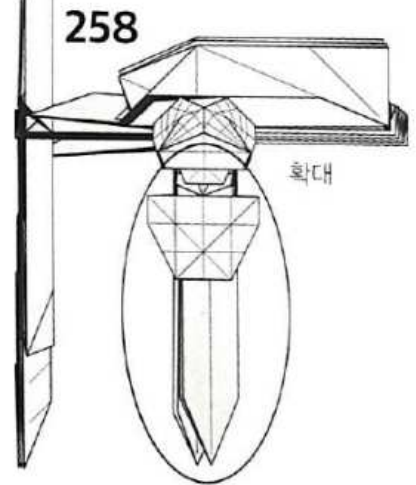
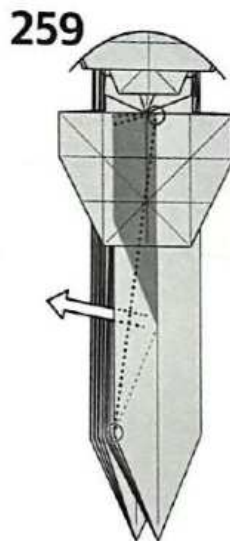
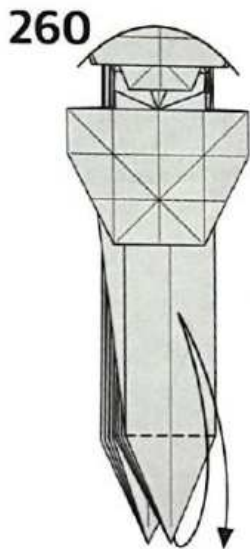
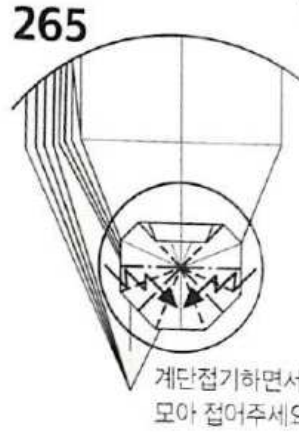
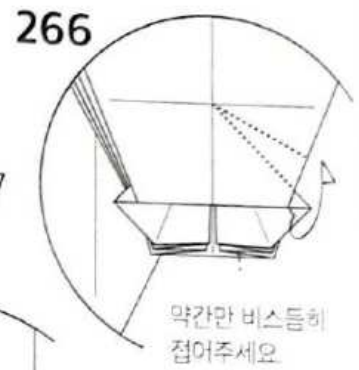
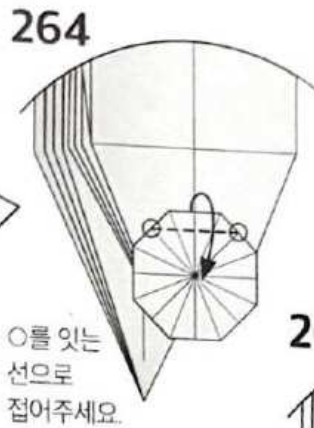
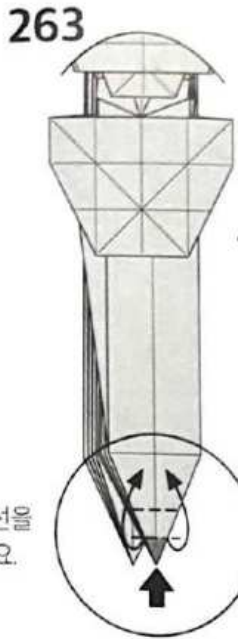
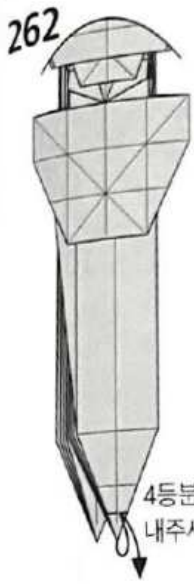

4등분 선을  
내주세요.

○를 잇는  
선으로  
접어주세요.

함몰접기  
(Spread Sink)

계단접기하면서  
모아 접어주세요.

약간만 비스듬히  
접어주세요.

2등분 선을  
내주세요.

접었다 편  
선을 내주세요.

○를 잇는 선으로  
안쪽 종이를 밖으로  
빼주세요.

확대

☆ 부분을  
양쪽으로 잡아  
당기면서  
펼쳐주세요.

선대로 눌러주면서 모아 접어주세요.

정면을  
봐주세요.

267



뒤에 있는 부분을  
뒤로 접어주세요.

268



266-267  
반대쪽도 266-267을  
반복해주세요.

269



뒤로 접어주세요.

270



뒤로 접어주세요.

275

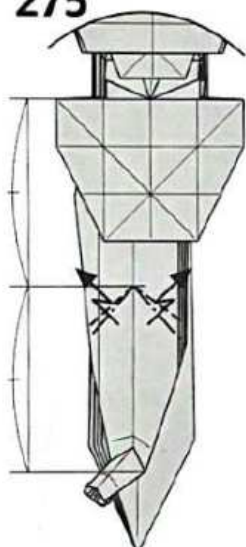

2등분 지점에서 무릎을  
만들어주세요.

274

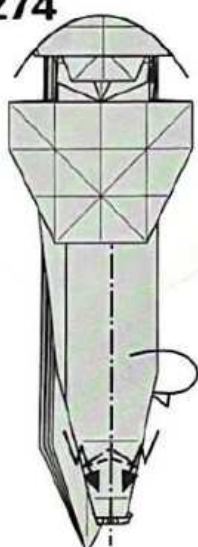

계단접기하면서  
발을 만들어주세요.

273

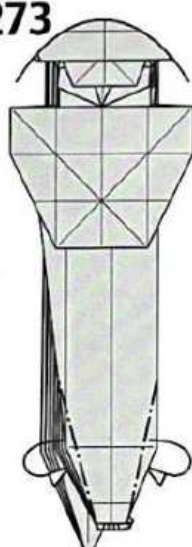

뒤로 접어주세요.

271



뒤로 접어주세요.

272

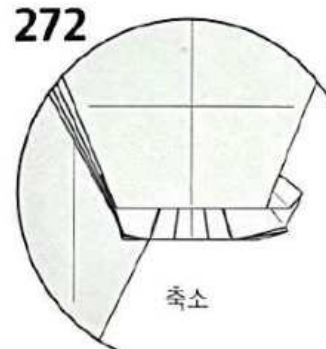

축소

276

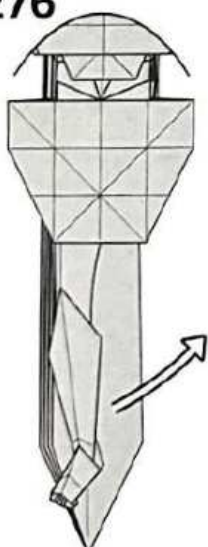

뒤에 있는 부분을  
앞으로 당겨주세요.

277

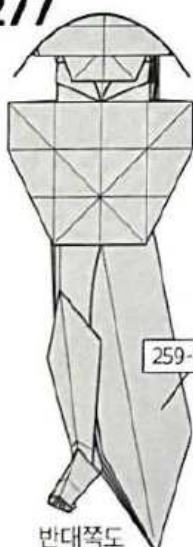

반대쪽도  
259-275를  
반복해주세요.

278

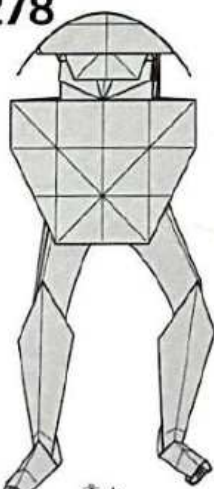

축소

279

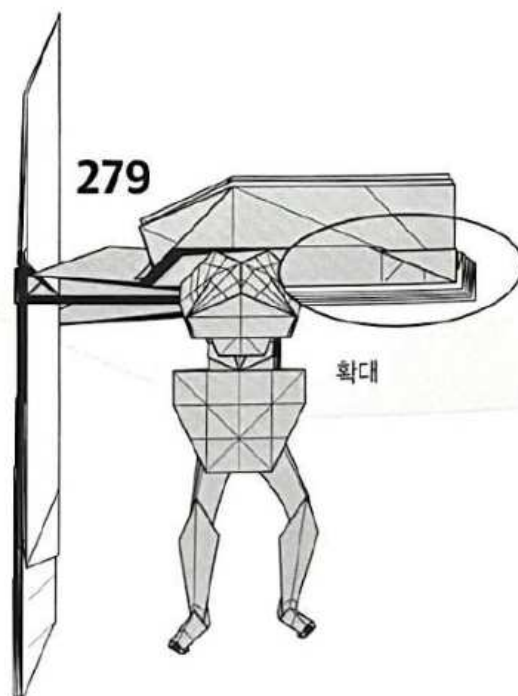

확대



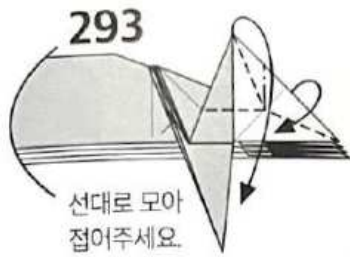

293 선대로 모아 접어주세요.

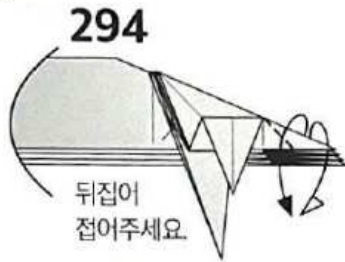

294 뒤집어 접어주세요.



297 남은 부분을 안쪽으로 접어 넣어주세요.

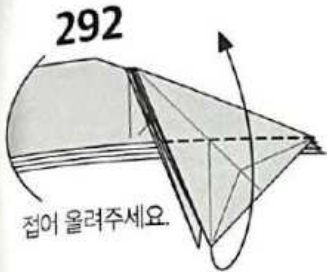

292 접어 올려주세요.

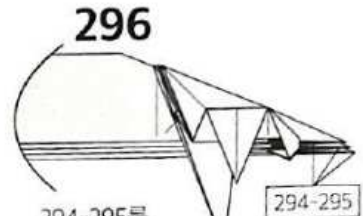

296 294-295를 3회 반복해주세요.

294-295

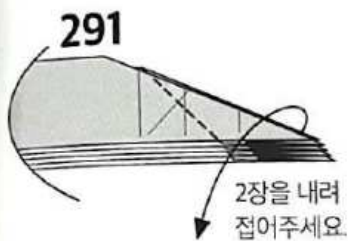

291 2장을 내려 접어주세요.



295 안쪽으로 접어주세요.

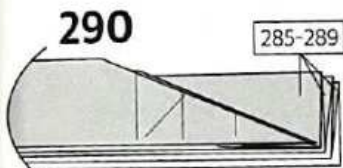

290 285-289를 3회 반복해주세요.

285-289

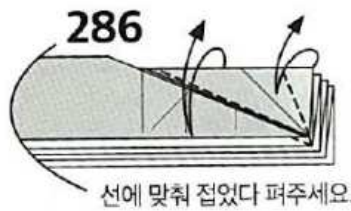

286 선에 맞춰 접었다 퍼주세요.

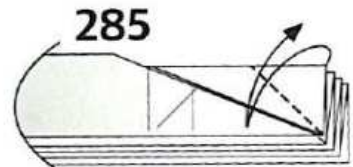

285 접었다 편 선을 내주세요.



289 안쪽으로 접어 넣어주세요.

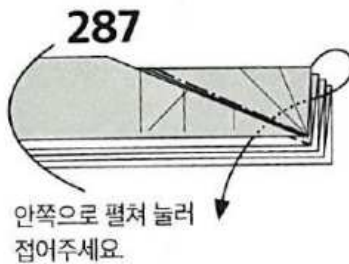

287 안쪽으로 펼쳐 눌러 접어주세요.

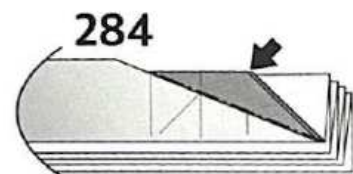

284 함몰접기 (Open Sink)



288 안쪽으로 펼쳐 눌러 접어주세요.



283 접었다 편 선을 내주세요.

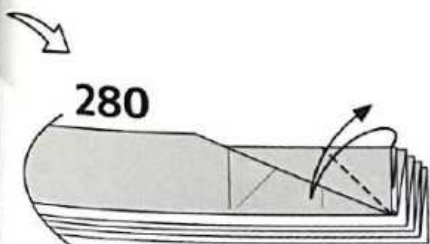

280 접었다 편 선을 내주세요.

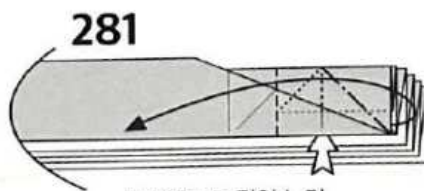

281 반대쪽으로 펼쳐 눌러 접어주세요.

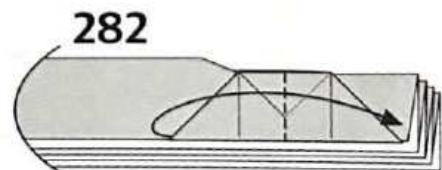

282 반대쪽으로 접어주세요.



298

축소

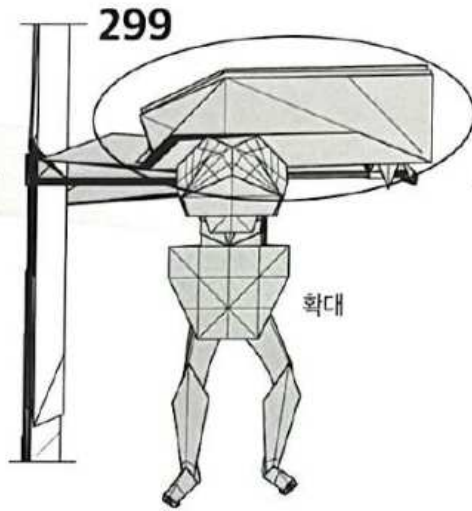

299

확대

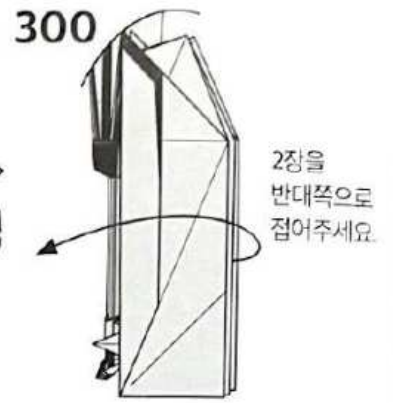

300

2장을  
반대쪽으로  
접어주세요.

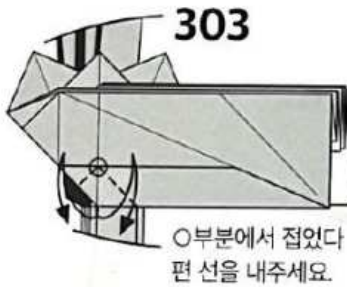

303

O부분에서 접었다  
편 선을 내주세요.

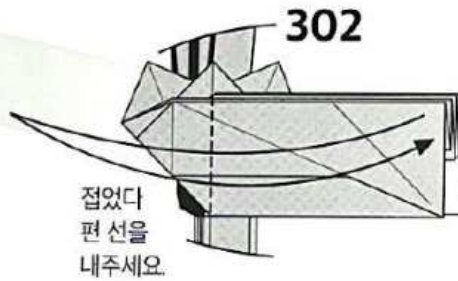

302

접었다  
편 선을  
내주세요.

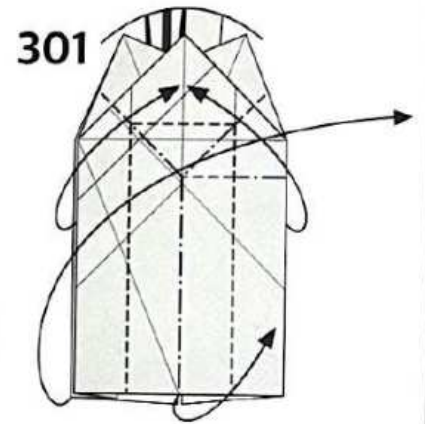

301

선대로 계단접기하면서  
모아 접어주세요.

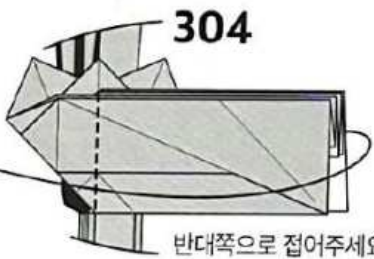

304

반대쪽으로 접어주세요.

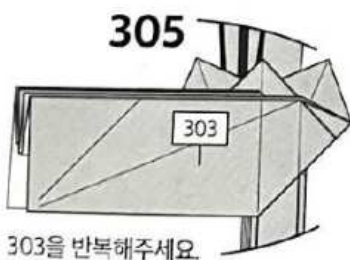

305

303을 반복해주세요.

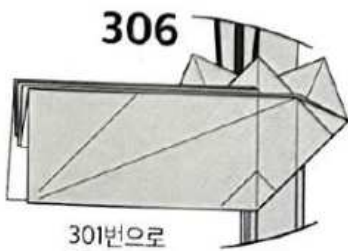

306

301번으로  
돌아가주세요.

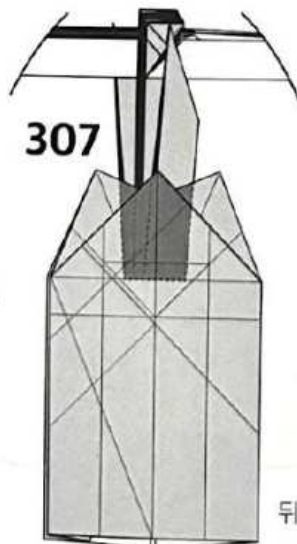

307

뒤집어주세요.

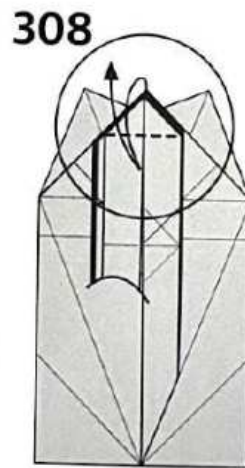

308

접었다 편 선을 내주세요.

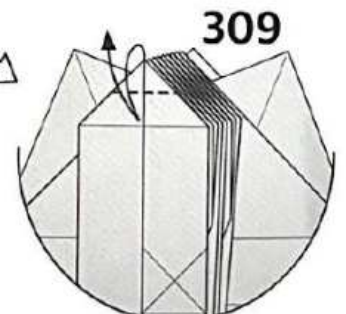

309

접었다 편 선을 내주세요.

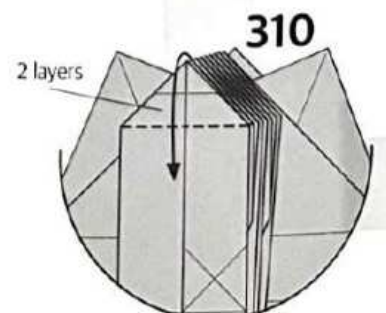

310

2장 내려 접어주세요.



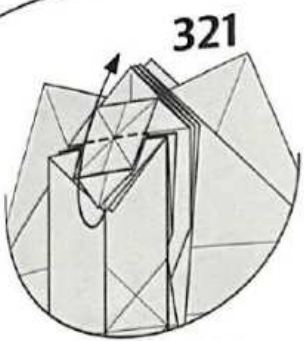

전부 올려 접어주세요.

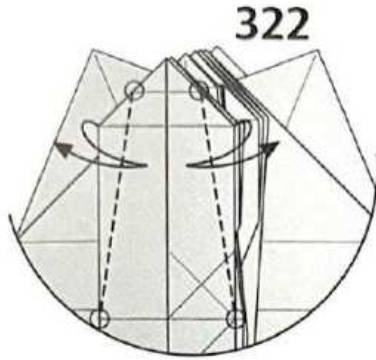

○를 잇는 선으로 접었다  
편 선을 내주세요.

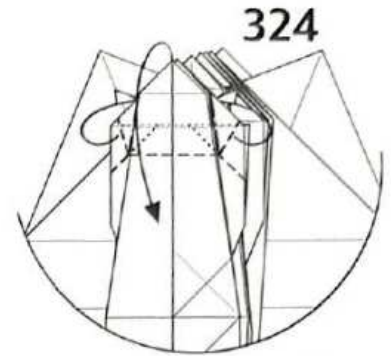

양쪽 끝을 뒤로 접으면서  
내려 접어주세요.

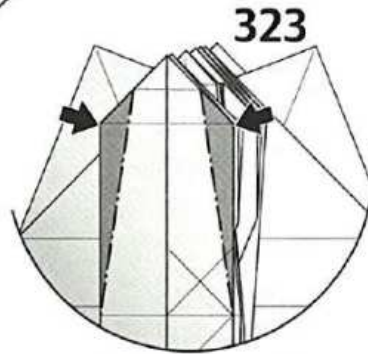

함몰접기 (Open Sink)

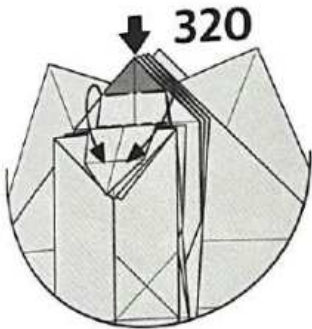

함몰접기하면서  
접어 내려주세요.

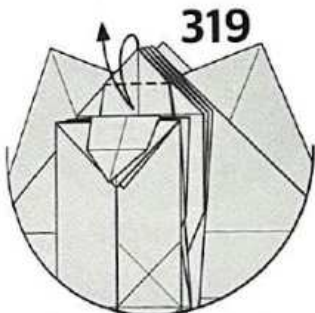

접었다 편 선을 내주세요.

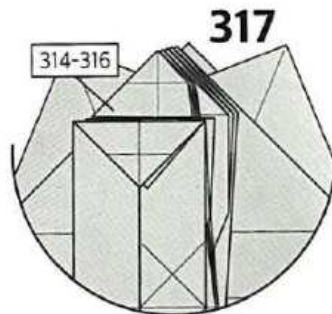

반대쪽도 314-316을  
반복해주세요.

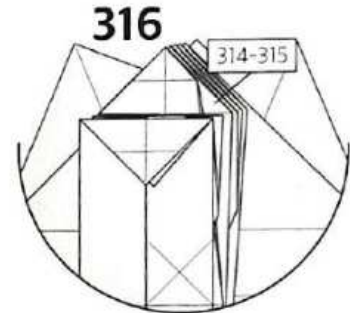

314-315를 반복해주세요.

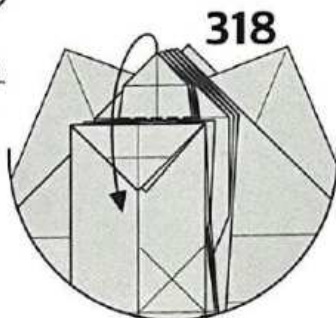

한장만 내려 접어주세요.

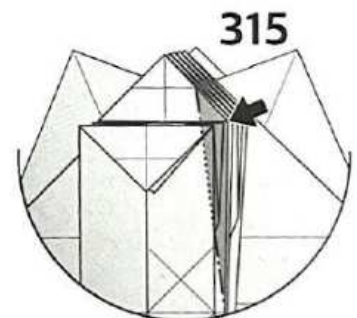

함몰접기 (Open Sink)

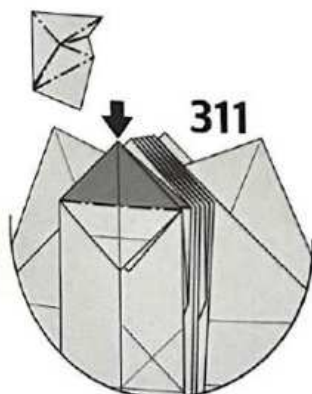

함몰접기 (Open Sink)

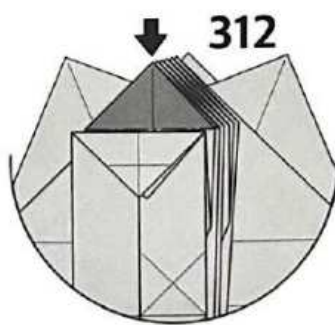

함몰접기 (Open Sink)

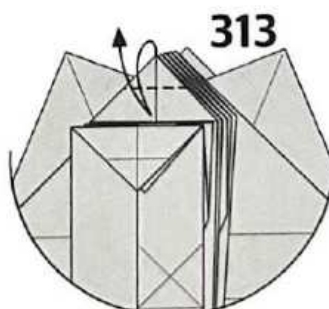

접었다 편 선을 내주세요.

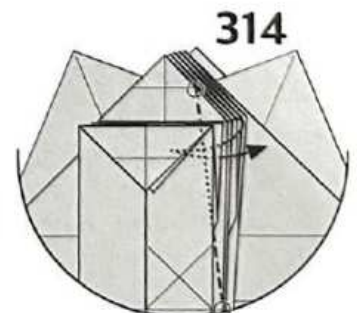

○를 잇는 선으로 접었다 퍼주세요.



325 평면이 되도록 접어주세요.

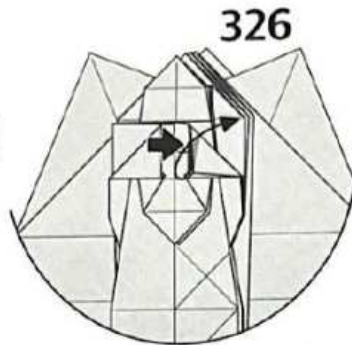

326 검은 부분을 눌러주면서 올려 접어주세요.

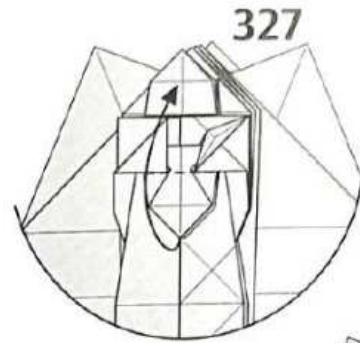

327 한장만 올려 접어주세요.

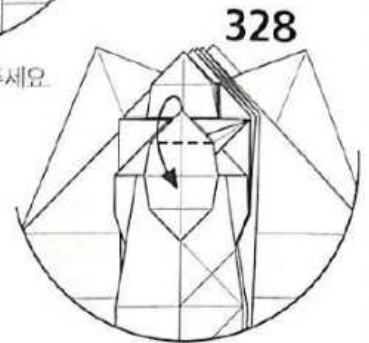

328 내려 접어주세요.

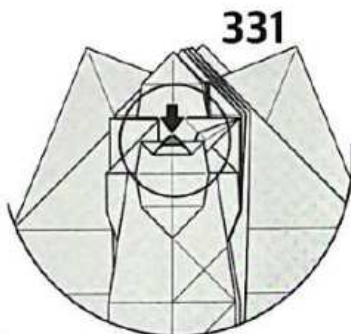

331 함몰접기하면서 아래로 펼쳐주세요. (Spread Sink)

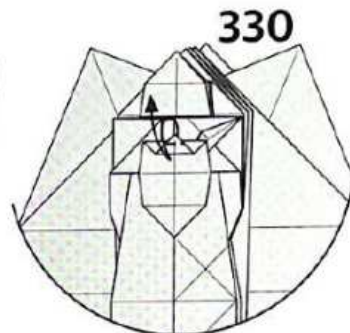

330 접었다 편 선을 내주세요.

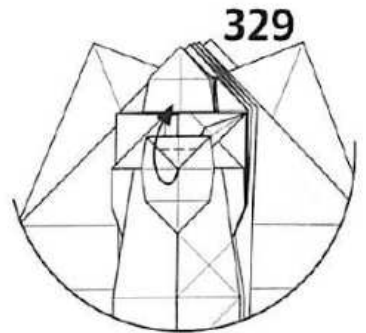

329 접어 올려주세요.

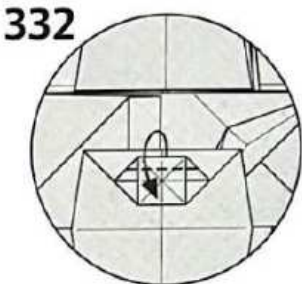

332 접어 내려주세요.

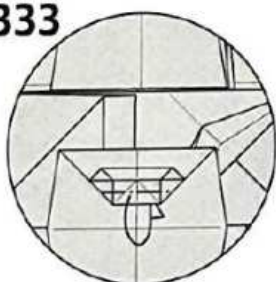

333 뒤로 접어주세요.

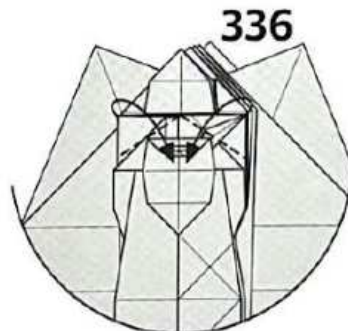

336 양쪽 다 내려 접어주세요.

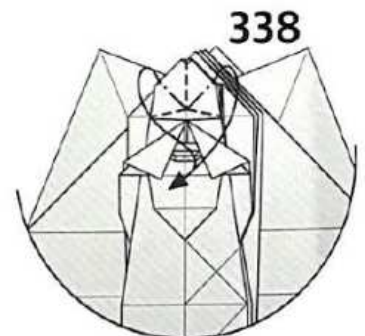

338 가운데로 모아 접어주세요.

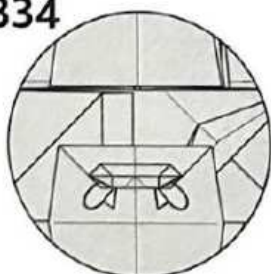

334 뒤로 접어주세요.

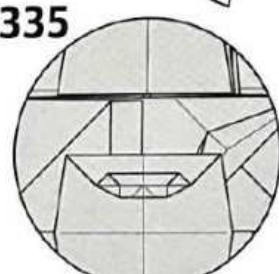

335 축소

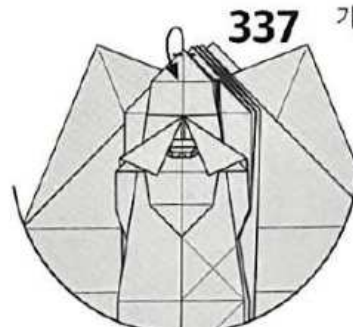

337 약간만 접어주세요.



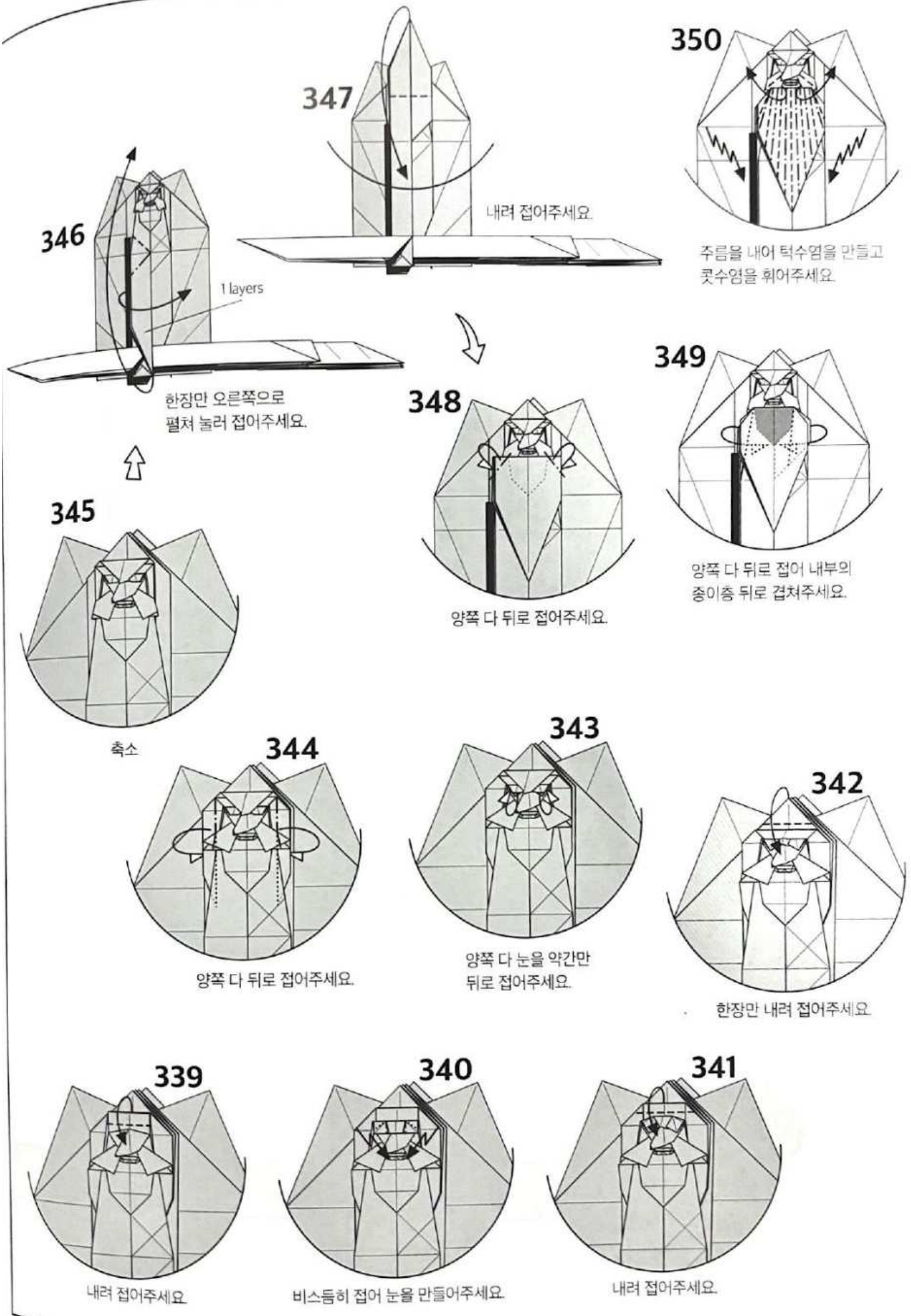

346

1 layers

한장만 오른쪽으로  
펼쳐 눌러 접어주세요.

347

내려 접어주세요.

350

주름을 내어 턱수염을 만들고  
콧수염을 휘어주세요.

349

양쪽 다 뒤로 접어 내부의  
종이층 뒤로 겹쳐주세요.

348

양쪽 다 뒤로 접어주세요.

345

축소

344

양쪽 다 뒤로 접어주세요.

343

양쪽 다 눈을 약간만  
뒤로 접어주세요.

342

한장만 내려 접어주세요.

339

내려 접어주세요.

340

비스듬히 접어 눈을 만들어주세요.

341

내려 접어주세요.

351



축소



352

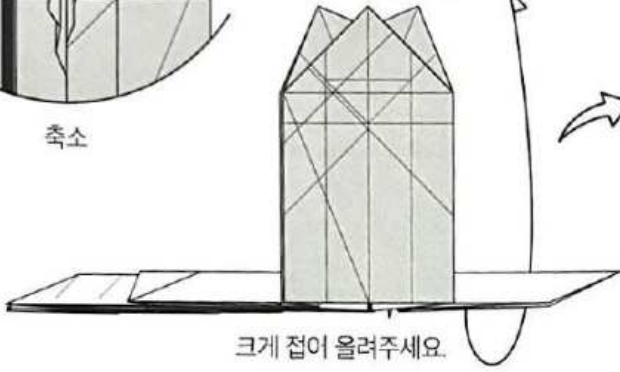

크게 접어 올려주세요.

353

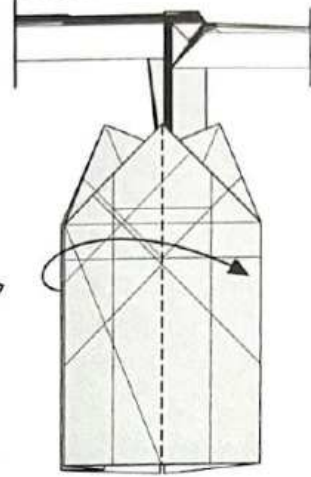

반대쪽으로 접어주세요.

354

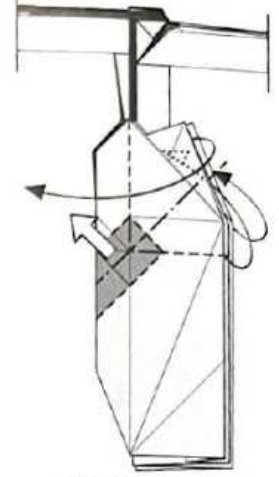

검은 부분을 밖으로  
접어주면서 반대쪽으로  
모아 접어주세요.

358

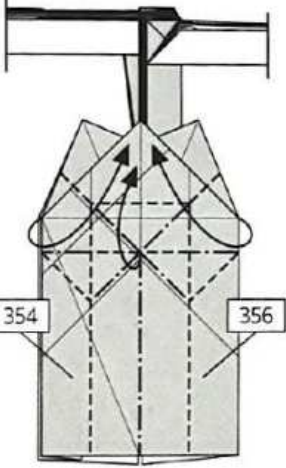

동시에 354, 356을 진행하면서  
모아 접어주세요.

357

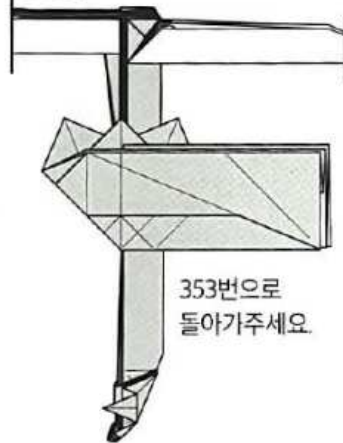

353번으로  
돌아가주세요.

356

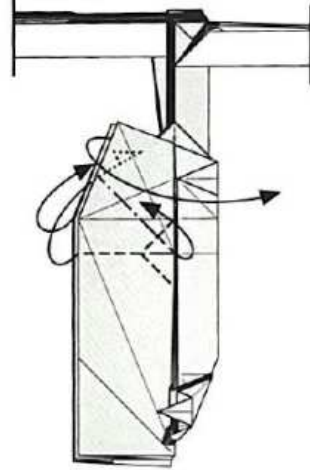

선대로 접어주면서  
반대쪽으로 모아 접어주세요.

355

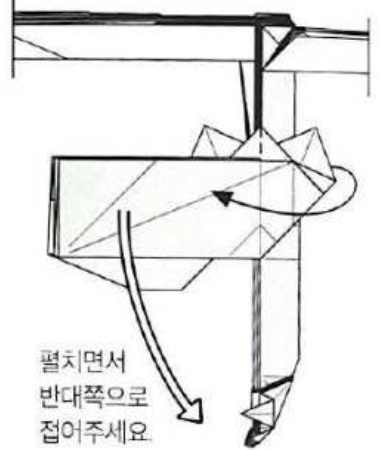

펼치면서  
반대쪽으로  
접어주세요.

359

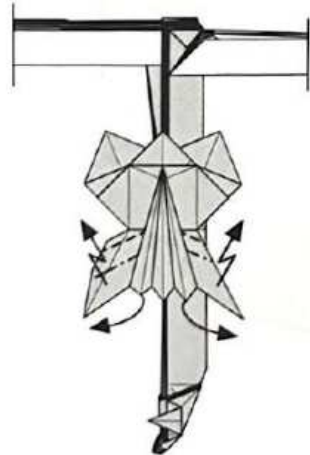

계단접기하면서  
평면으로 접어주세요.

360

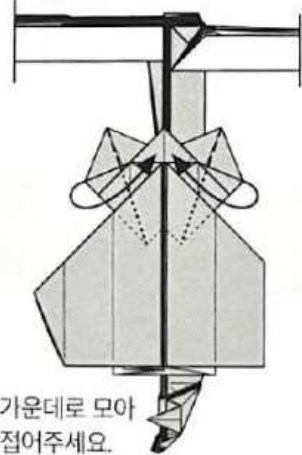

가운데로 모아  
접어주세요.

361

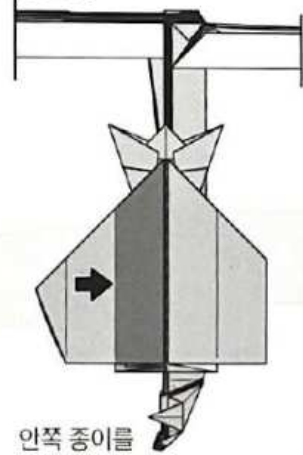

안쪽 종이를  
밖으로 빼주세요  
(unsink)

362

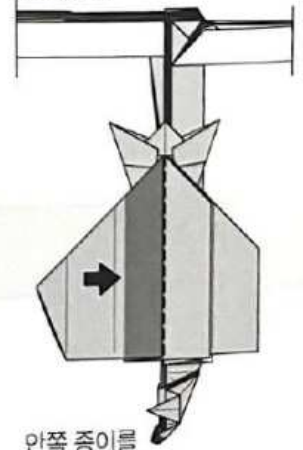

안쪽 종이를  
밖으로 빼주세요  
(unsink)



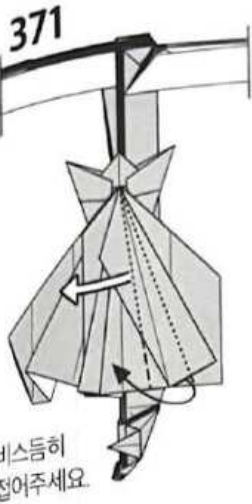

371  
비스듬히  
접어주세요.

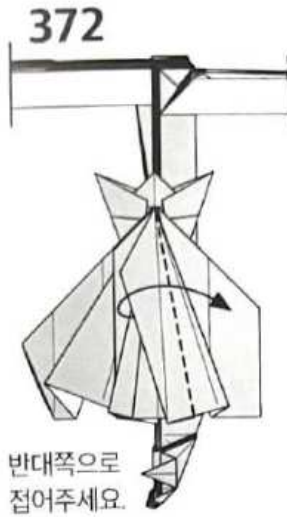

372  
반대쪽으로  
접어주세요.

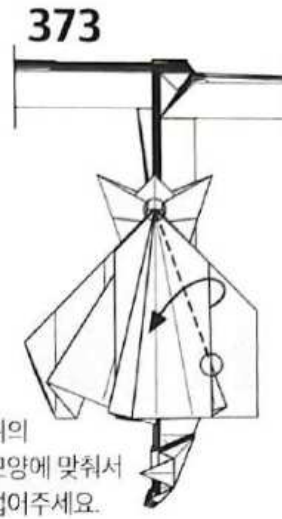

373  
뒤의  
모양에 맞춰서  
접어주세요.



374  
함몰접기하면서  
넘겨 접어주세요.  
(Open Sink)

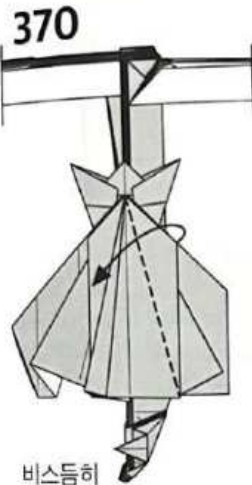

370  
비스듬히  
한장을 반대쪽으로  
접어주세요.

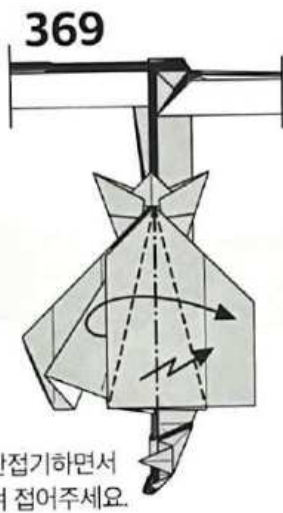

369  
계단접기하면서  
넘겨 접어주세요.



368  
○를 잇는 선으로  
접었다 편 선을 내주세요.

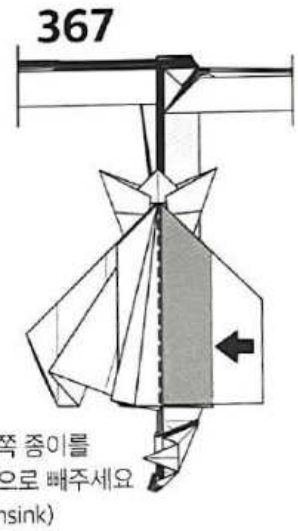

367  
안쪽 종이를  
밖으로 빼주세요.  
(unsink)

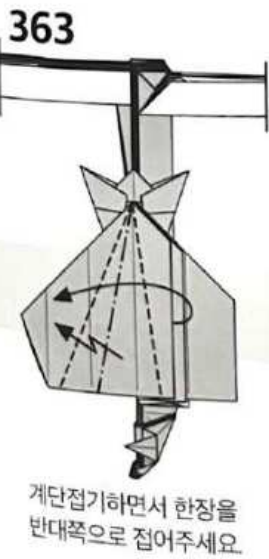

363  
계단접기하면서 한장을  
반대쪽으로 접어주세요.

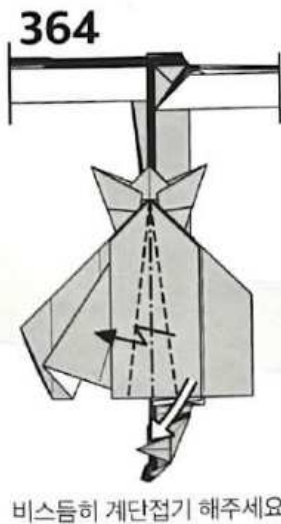

364  
비스듬히 계단접기 해주세요.

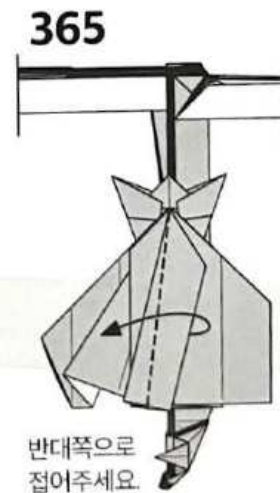

365  
반대쪽으로  
접어주세요.

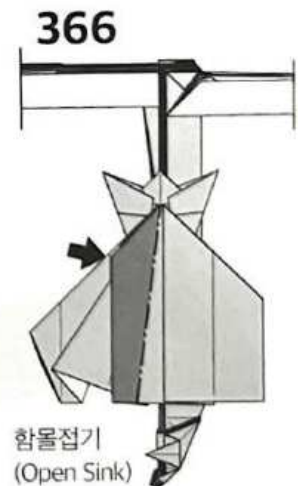

366  
함몰접기  
(Open Sink)

375



함몰접기  
(Open Sink)

376

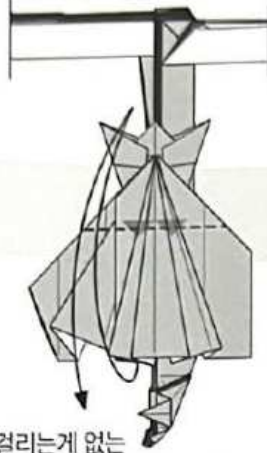

걸리는게 없는  
가장 위쪽에 선을 내주세요.

377

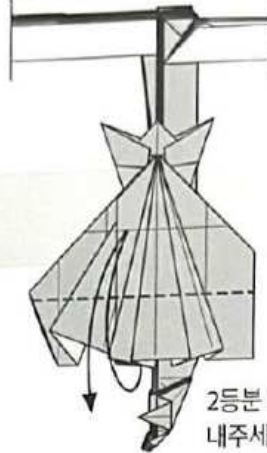

2등분 선을  
내주세요.

378

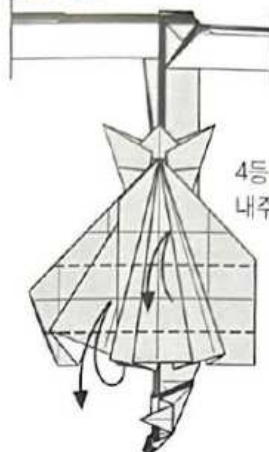

4등분 선을  
내주세요.

379

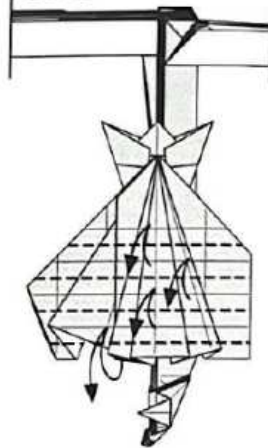

8등분 선을 내주세요.

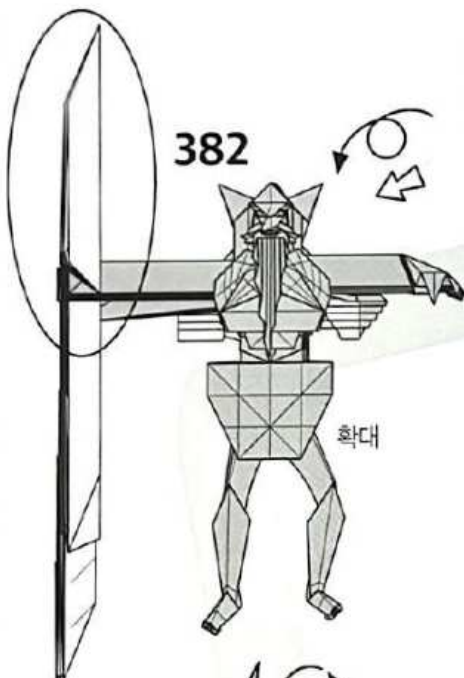

382

확대

축소

381

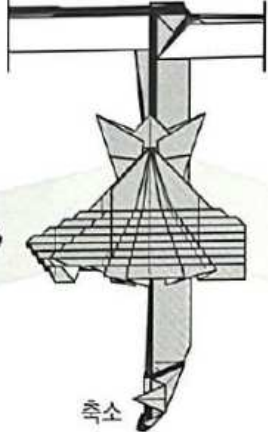

380

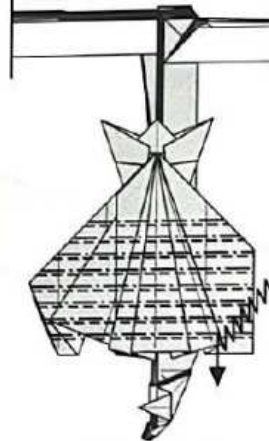

계단접기 해주세요.



383

올려 접어주세요.

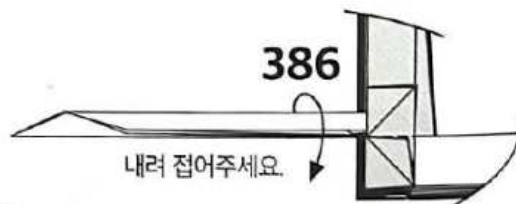

386

내려 접어주세요.



385

펼쳐 눌러 접어주세요.



384

반으로 접어주세요.



387

접어 올려서 긴 가지를  
감싸주세요.





397  
반의 간격으로 안쪽으로  
펼쳐 눌러 접어주세요.



396  
반대쪽도 388-395를 반복해주세요. 388-395



395  
가지를 90도로  
세워주세요.

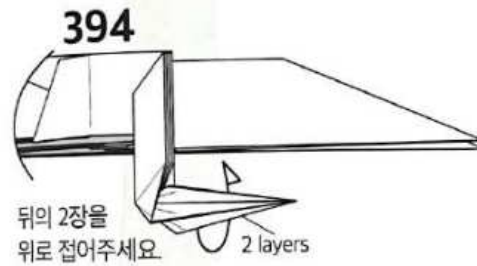

394  
뒤의 2장을  
위로 접어주세요. 2 layers

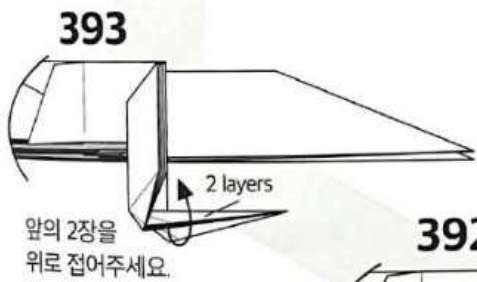

393  
앞의 2장을  
위로 접어주세요. 2 layers

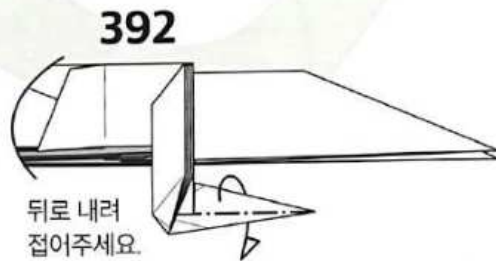

392  
뒤로 내려  
접어주세요.

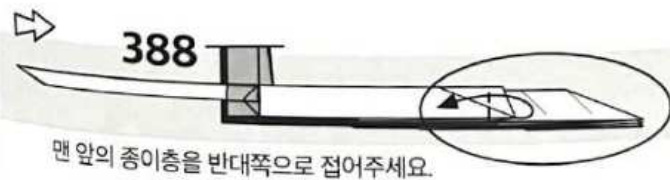

388  
맨 앞의 종이층을 반대쪽으로 접어주세요.

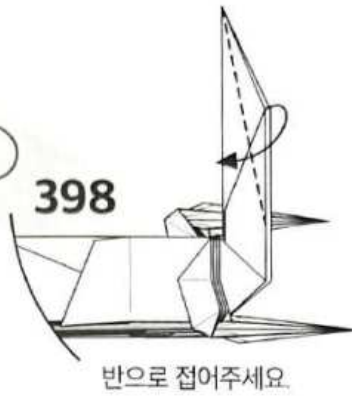

398  
반으로 접어주세요.



399  
곡선으로 다듬어주세요.

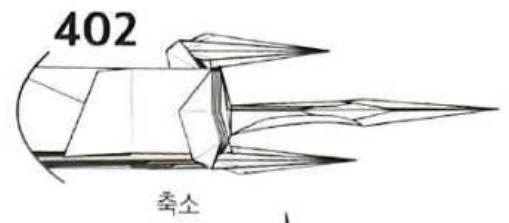

402  
축소

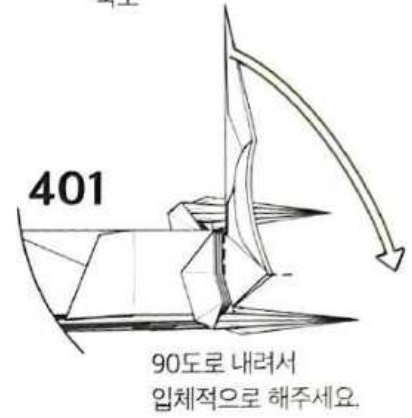

401  
90도로 내려서  
입체적으로 해주세요.

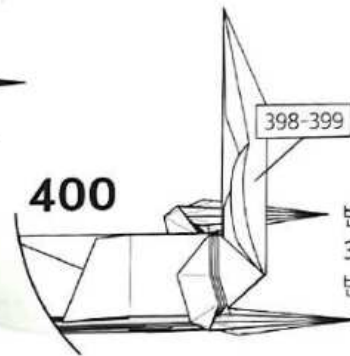

400  
반대쪽도  
398-399를  
반복해주세요.

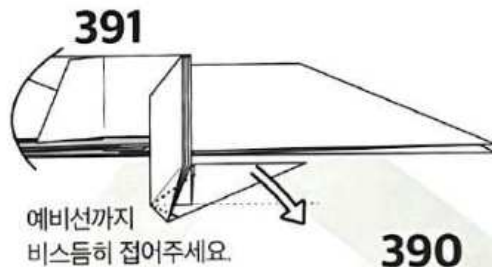

391  
예비선까지  
비스듬히 접어주세요.

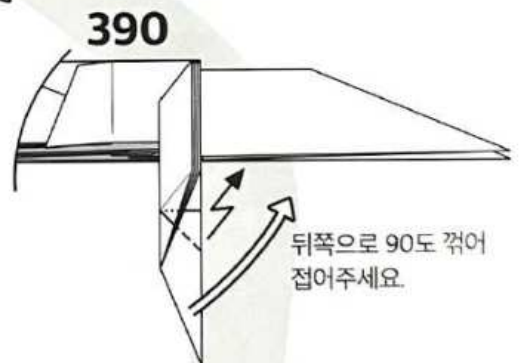

390  
뒤쪽으로 90도 꺾어  
접어주세요.

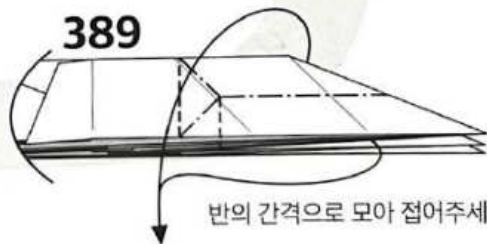

389  
반의 간격으로 모아 접어주세요.

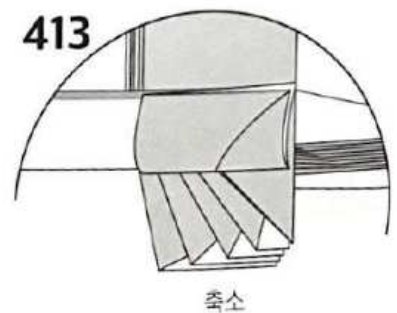
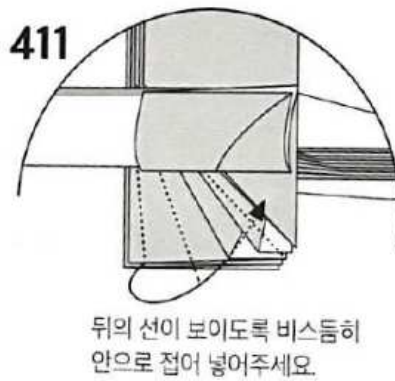
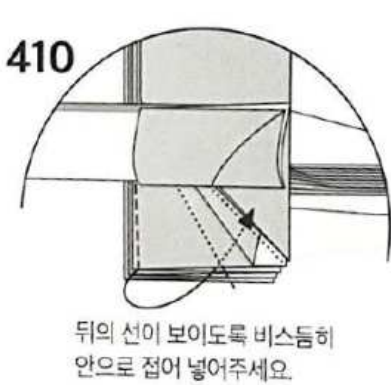
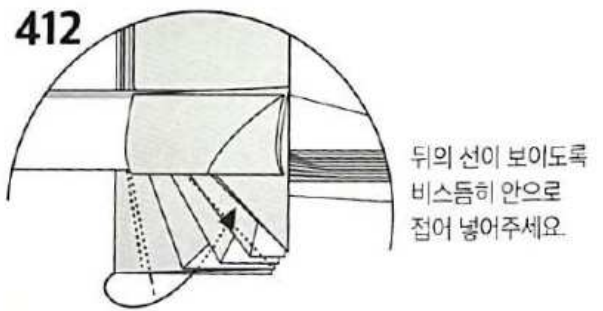
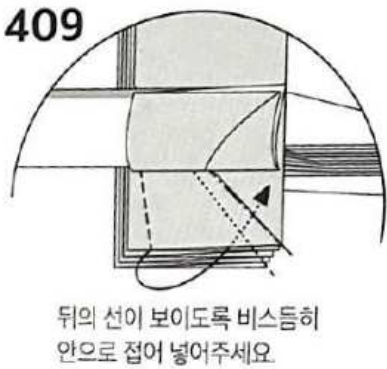
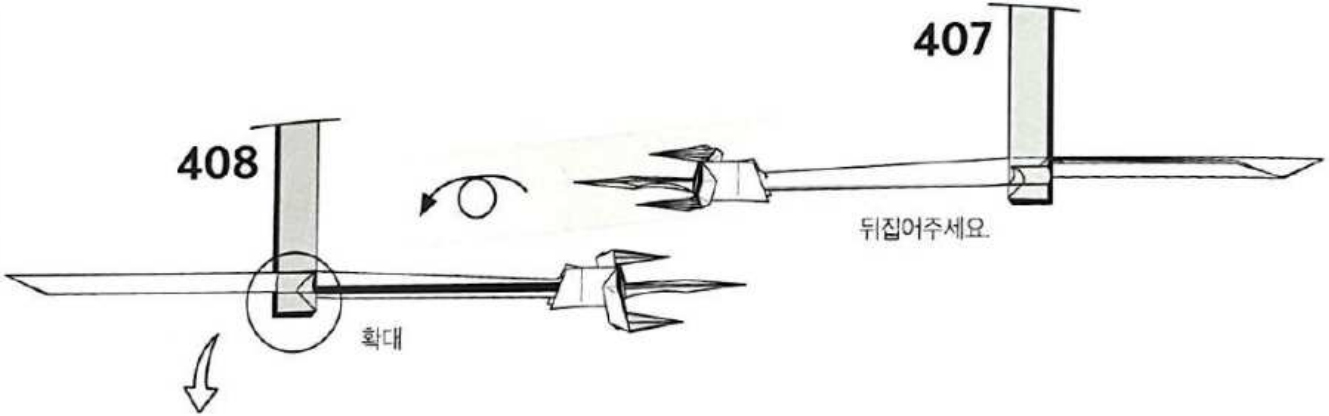
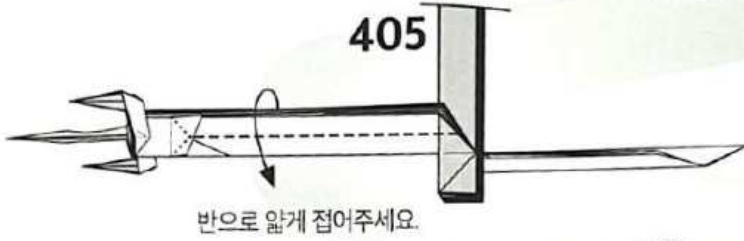
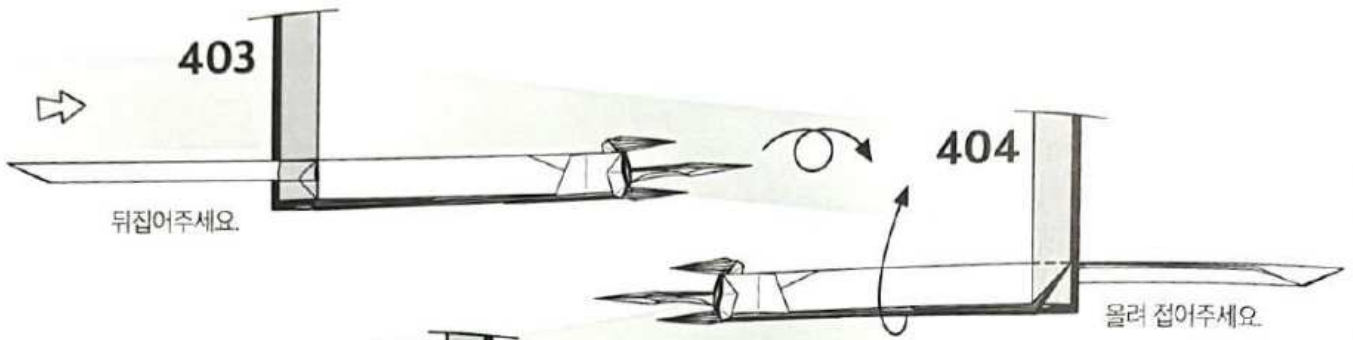





선을 내지 않고  
아래로 내려주세요.



선을 내지 않고  
위로 올려주세요.

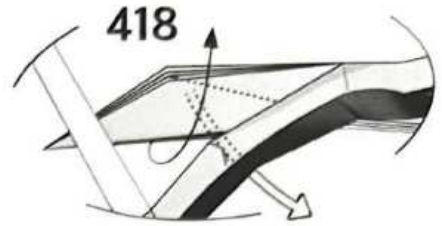

맨 앞의 한장을 펼치며  
두번째 장에 골짜기접기를 해주세요.

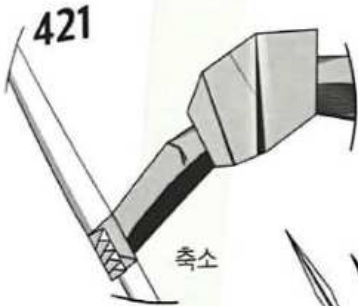

축소

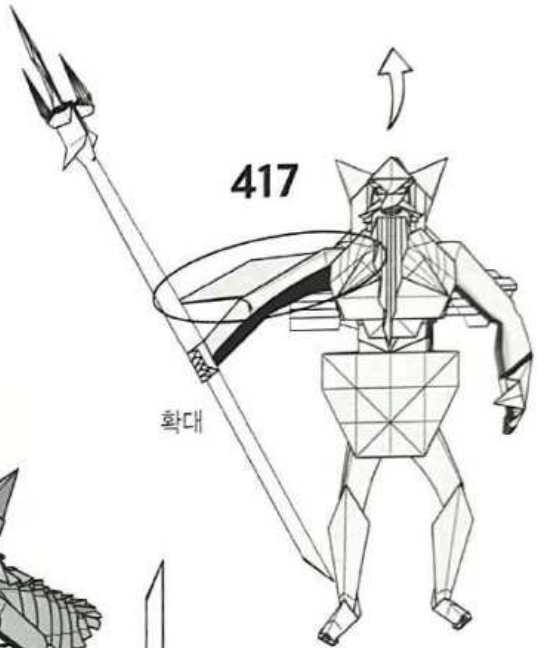

확대

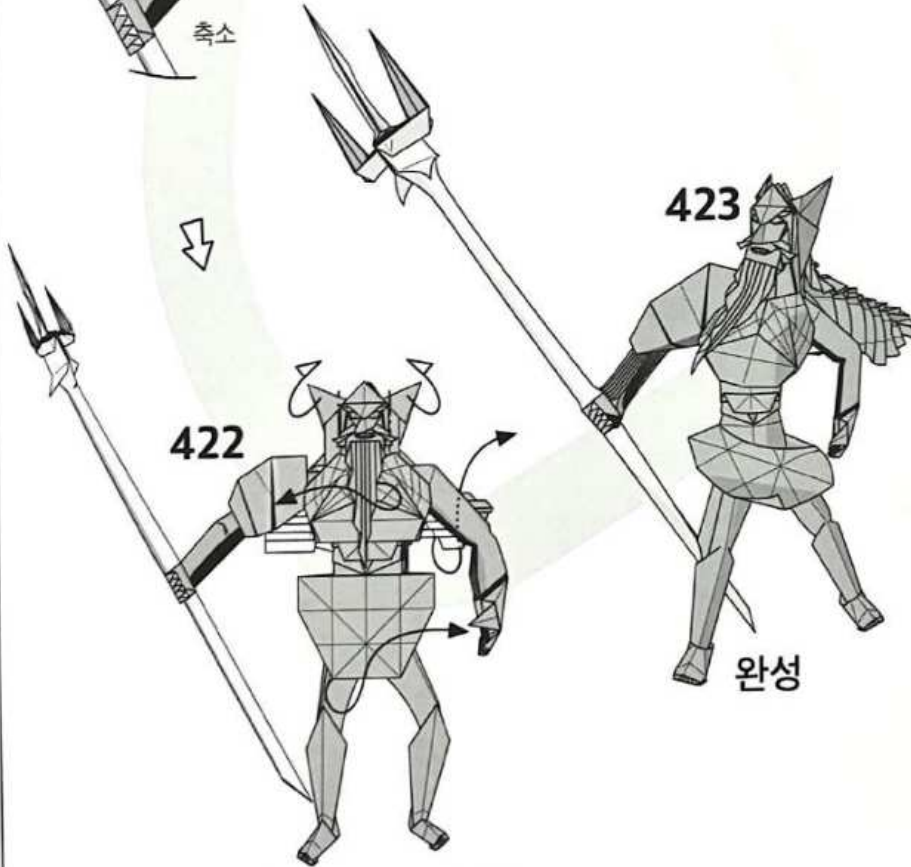

422

머리카락, 옷을 휘어주고 양관을  
뒤로 접어 입체적으로 해주세요.

423

완성

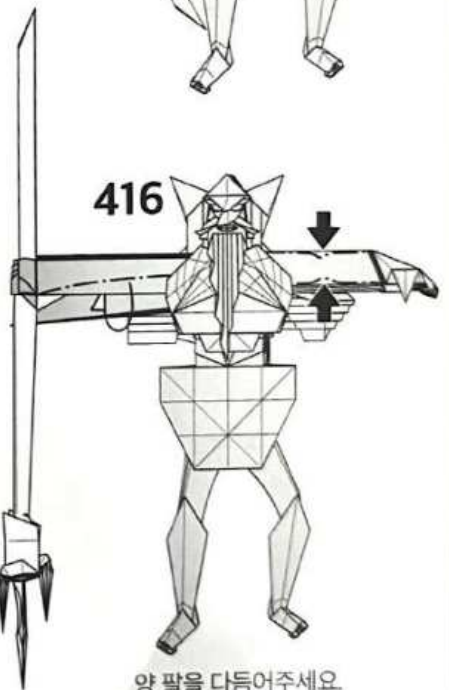

416

양 팔을 다듬어주세요.

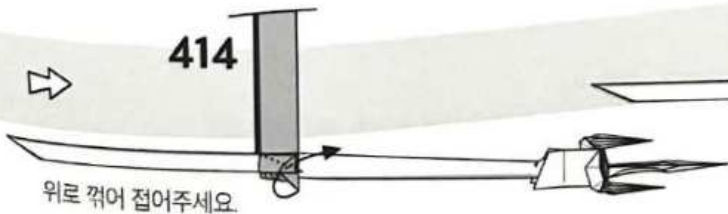

414

위로 꺾어 접어주세요.

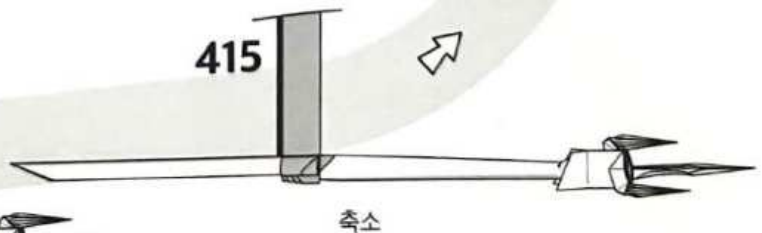

415

축소

종이접기 매니아를 위한

# ORIGAMI PRO

신화 종이접기편

초판1쇄 인쇄 ◆ 2024년 07월 31일

초판1쇄 발행 ◆ 2024년 08월 09일

참 여 작 가 ◆ 김진우, 장용익, 이인섭, 유태용, 맹형규, 정재일, 한지우, 박종우

기획 / 편집 ◆ 김진우, 장용익, 유태용

감 수 ◆ 김진우, 한지우

진 행 ◆ 이송윤, 이경구

도면 디자인 ◆ 장용익, 이인섭, 유태용, 맹형규, 정재일, 박종우

표지 디자인 ◆ 장용익

발 행 인 ◆ 주안나

펴 낸 곳 ◆ (사)한국종이접기협회

주 소 ◆ 서울시 중구 다산로64 (신당동 366-104)

전 화 ◆ 02-2264-4561

팩 스 ◆ 02-2264-4565

홈 페이지 ◆ [www.origami.or.kr](http://www.origami.or.kr)

등록 번호 ◆ 제6-0112호

- 이 책은 저작권법에 따라 보호받는 저작물이므로 무단전재와 복제를 금합니다.

- 이 책 내용의 전부 또는 일부를 이용하려면 반드시 저작권자와 (사)한국종이접기협회의 서면 동의를 받아야합니다.

- (사)한국종이접기협회에서 출간되는 [ORIGAMI PRO\_신화 종이접기편]의 판매 수익금은 창작 종이접기 작가 육성을 위해 사용됩니다.



값 28,000원

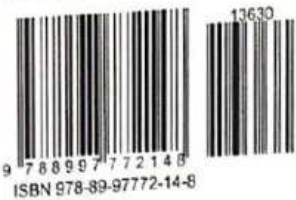

## 한국 종이접기 창작가의 신화 종이접기

신화 종이접기편에서는 전설과 신화 속 주인공들을 종이접기로 만나보실 수 있습니다.



사단법인 한국종이접기협회  
KOREA ORIGAMI ASSOCIATION