

EASY ORIGAMI

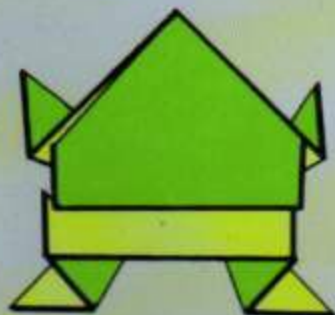

John
Montroll

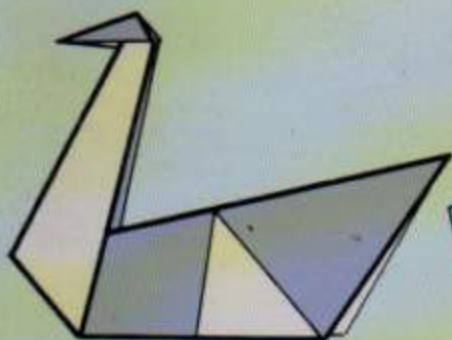
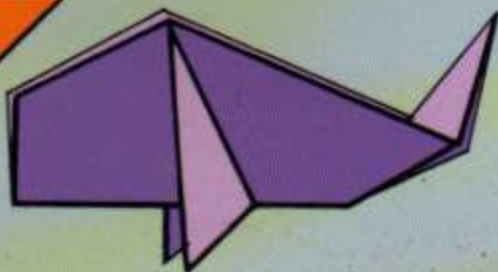
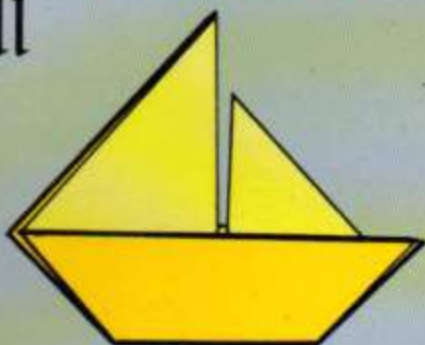
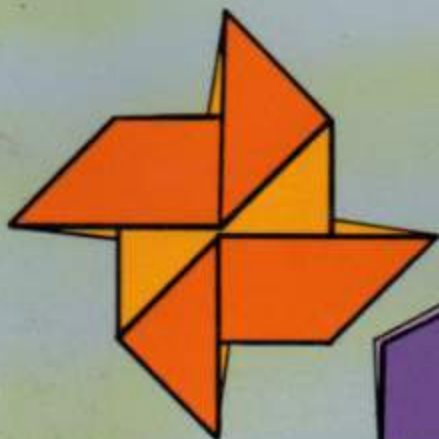
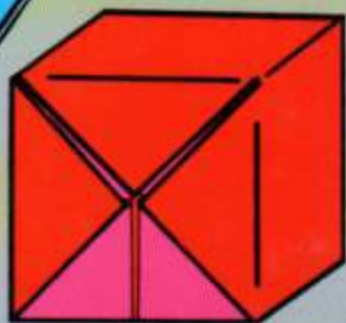

Easy Origami

John Montroll

Dover Publications, Inc., New York

Copyright © 1992 by John Montroll.
All rights reserved under Pan American and International Copyright
Conventions.

Published in Canada by General Publishing Company, Ltd., 30
Lesmill Road, Don Mills, Toronto, Ontario.

Published in the United Kingdom by Constable and Company, Ltd., 3
The Lanchesters, 162-164 Fulham Palace Road, London W8 9ER.

Easy Origami is a new work, first published by Dover Publications,
Inc., in 1992.

Manufactured in the United States of America
Dover Publications, Inc., 31 East 2nd Street, Mineola, N.Y. 11501

Library of Congress Cataloging-in-Publication Data

Montroll, John.
Easy origami / John Montroll.
p. cm.
ISBN 0-486-27298-2 (pbk.)
I. Origami. I. Title.
TT870.M554 1992
738'.982—dc20

92-10933
CIP

Introduction

I have compiled this collection of traditional Japanese projects for beginners in the hope of sparking a life-long interest in this ancient, elegant art. The models you will fold out of this book, such as a house that turns into a piano, a sailboat, assorted boxes, and other old favorites should provide a good foundation as you move on to more advanced paper folding.

The diagrams are drawn in the internationally approved Randlett-Yoshizawa style, which, you will find, is easy to follow once you have learned the basic folds. You can use any kind of square paper for these models, but the best results and most precise folding can be achieved using standard origami paper, which is colored on one side and white on the other. In these diagrams, the shading represents the colored side. Origami paper can be found in many hobby shops or purchased by mail from The Friends of The Origami Center of America, a non-profit organization of dedicated paperfolders. For more information about the Friends, send a self-addressed, business-size envelope with two first-class stamps to:

The Friends of The Origami Center of America
15 West 77th St.
New York, NY 10024-5192

Origami paper, and a catalog of other available craft books, can also be ordered from Dover Publications, Inc., at:

Dover Publications, Inc.
31 East 2nd St.
Mineola, NY 11501

Good Luck and Happy Folding!

John Montroll

Contents

Symbols 6



Dog
Page 8



Cat
Page 9

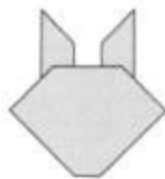

Rabbit
Page 10



Horse
Page 11



Fish
Page 12



Penguin
Page 13

Tulip
Page 14



Stem
Page 15



Cup
Page 16



Hat
Page 17



Tall Cap
Page 18



Boat
Page 19



House
Page 20

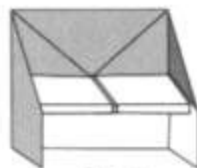

Piano
Page 21



Oblong Box
Page 22



Fox
Page 23

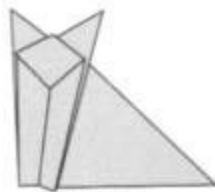

Sitting Fox
Page 24



Cicada
Page 25

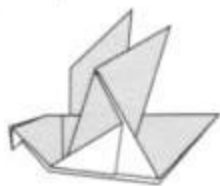

Pigeon
Page 26



Pelican
Page 27



Pin Wheel
Page 28

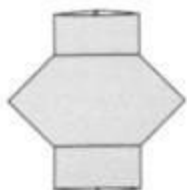

Lantern
Page 29



Swan
Page 30



Star
Page 31

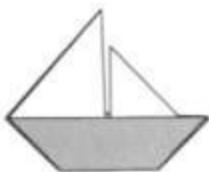

Sailboat
Page 32

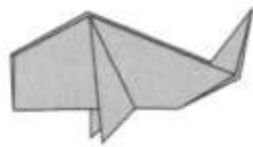

Carp
Page 34



Butterfly
Page 36



Frog
Page 38

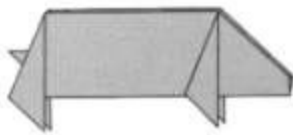

Pig
Page 40



Waterbomb
Page 42



Candy Box
Page 44



Fancy Box
Page 46

Symbols

Lines



Valley fold, fold in front.



Mountain fold, fold behind.



Crease line.



X-ray or guide line.

Arrows



Fold in this direction.



Fold behind.



Unfold.



Fold and unfold.



Turn over.



Push.



Place your finger between these layers.

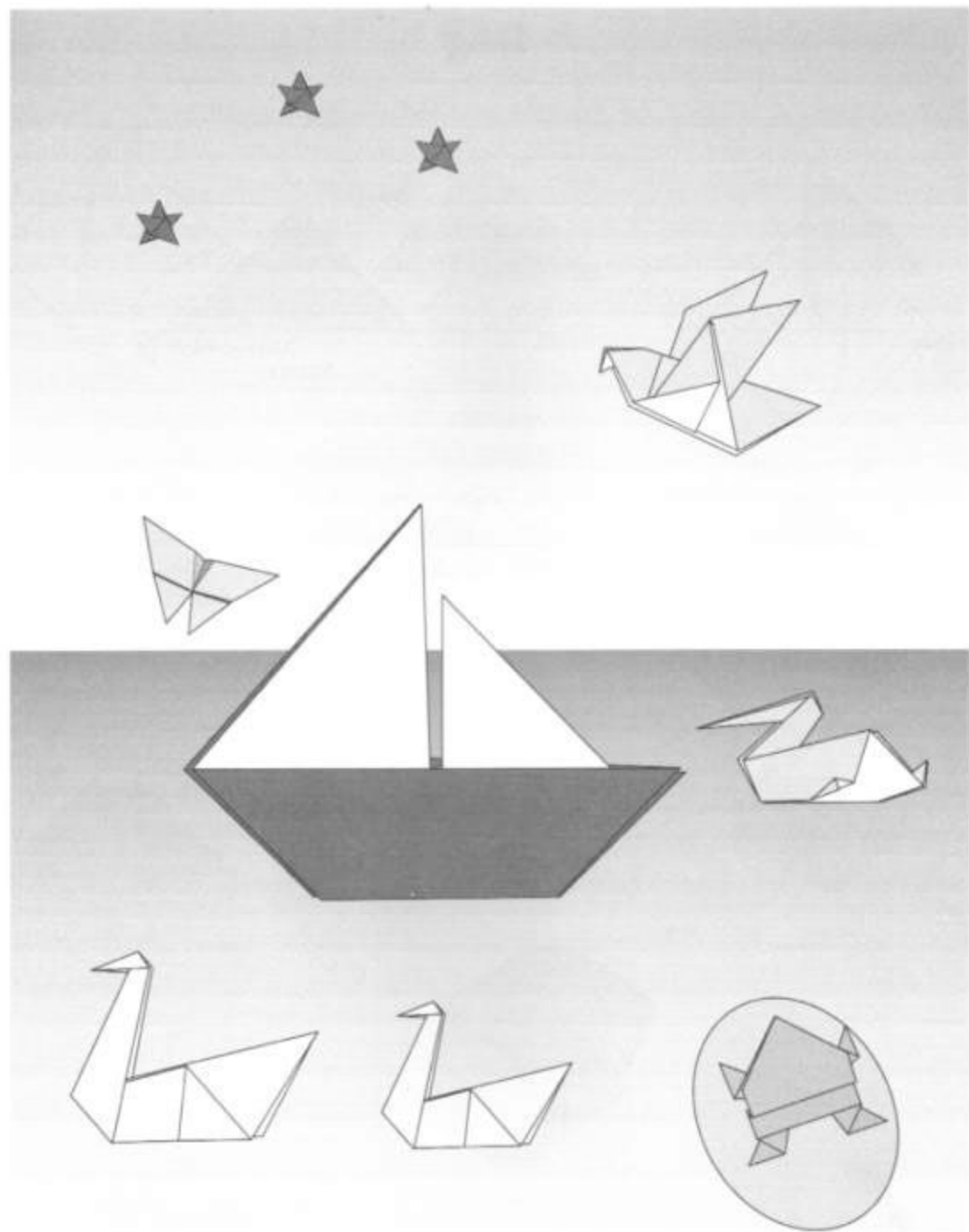

Dog

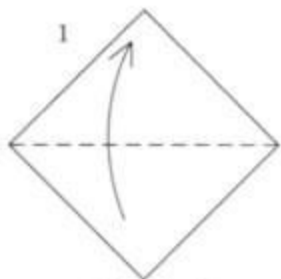

Fold in half.

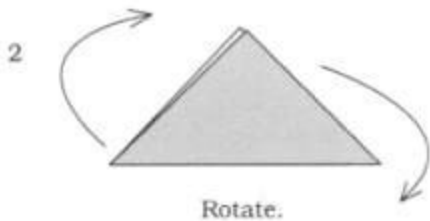

Rotate.

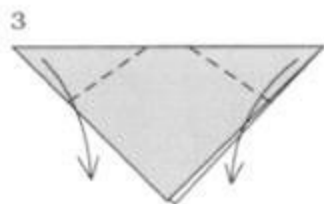

Fold the ears down.

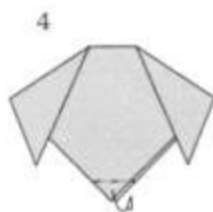

Fold behind.

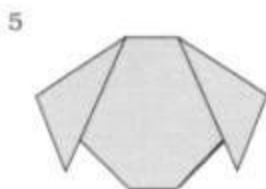

Dog

Cat

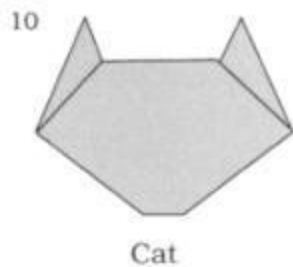
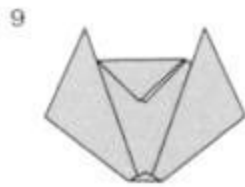
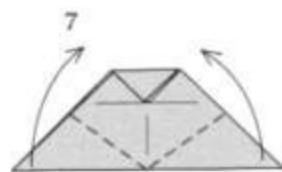
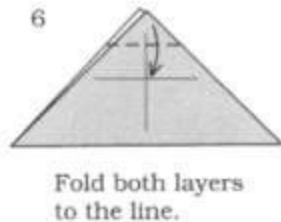
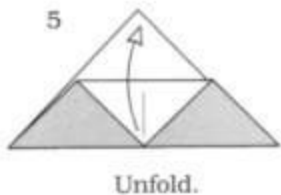
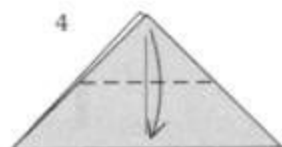
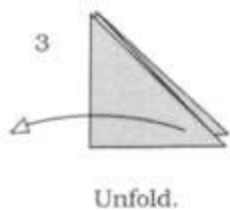
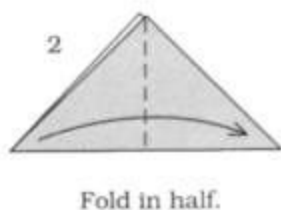
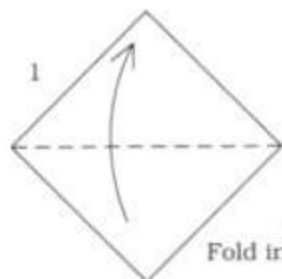

Rabbit

1

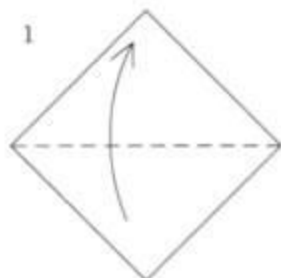

Fold in half.

2

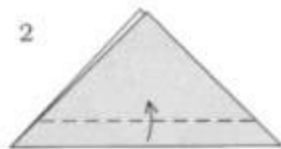

3



4

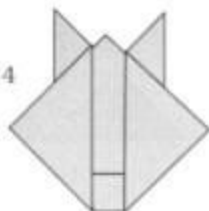

Turn over.

5



Fold behind.

6

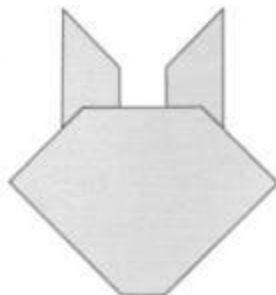

Rabbit

Horse

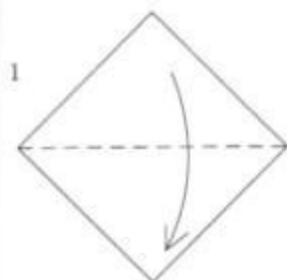

Fold in half.



Fold in half.

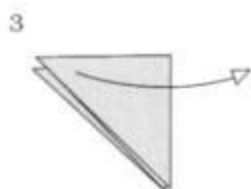

Unfold.

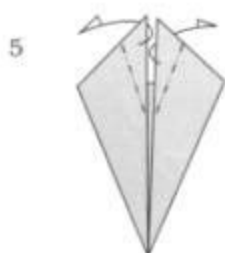
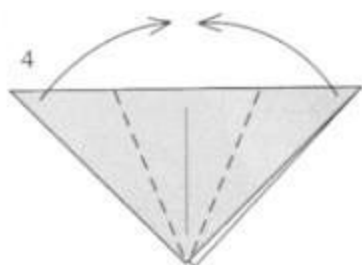

Fold the ears behind.

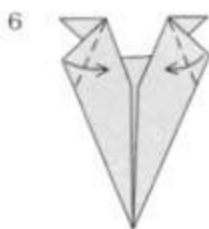

Turn over.

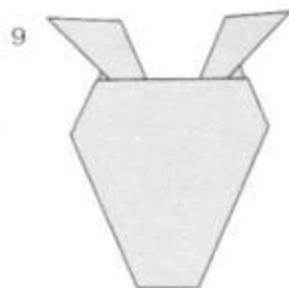

Horse

Fish

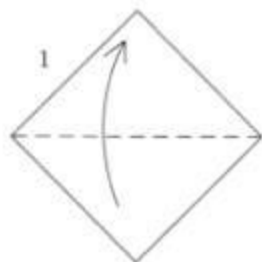

Fold in half.

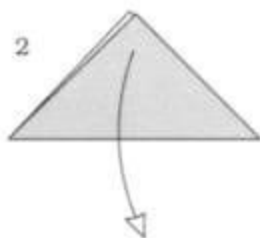

Unfold.

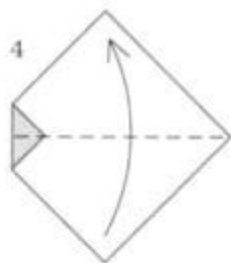
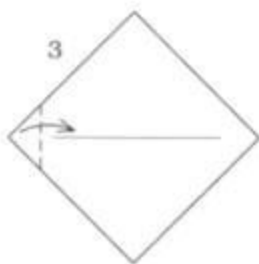

Fish

Penguin

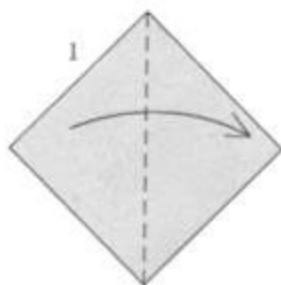

Fold in half.

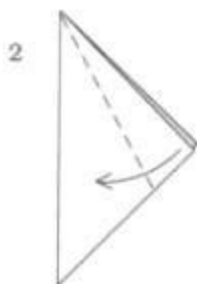

Repeat behind.

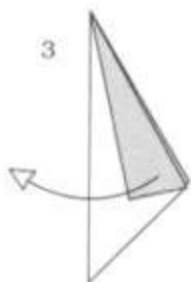

Unfold.

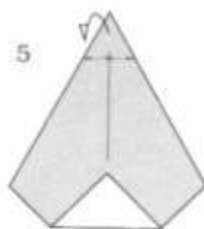
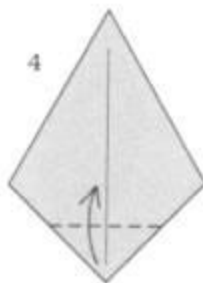

Fold behind.

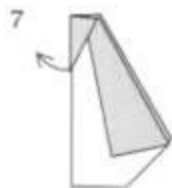
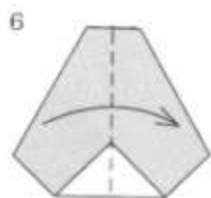

Slide up the head.

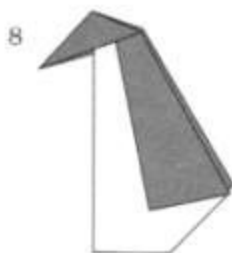

Penguin

Tulip

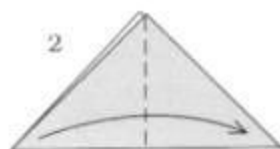
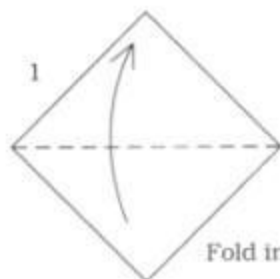

Fold in half.



Unfold.



Fold behind.

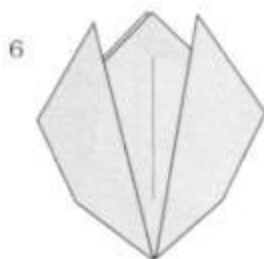

Tulip

Stem

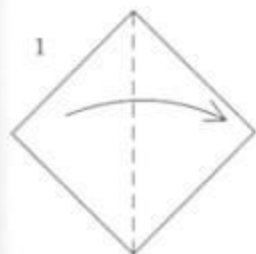

Fold in half.

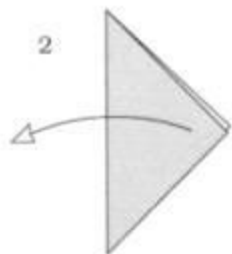

Unfold.

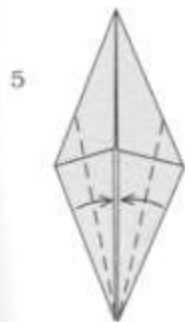
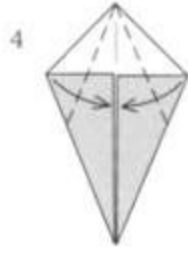
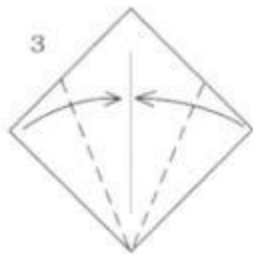

Slide out.

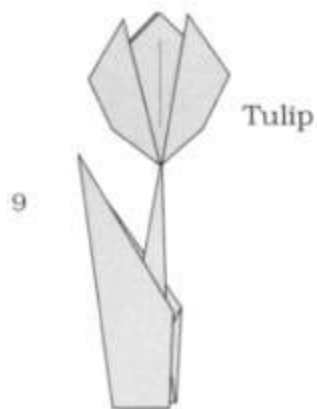

Tulip

Stem

Cup

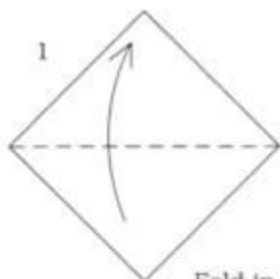

Fold in half.



Fold one side down.

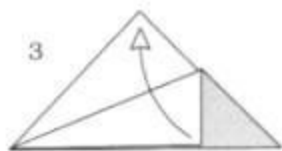

Unfold.

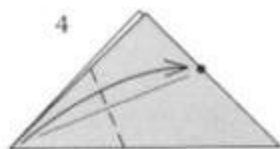

Fold the corner to the dot.

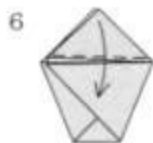

Fold one layer down.

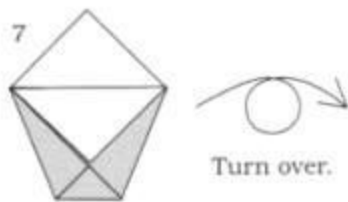

Turn over.

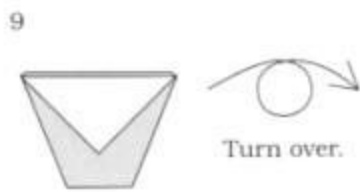
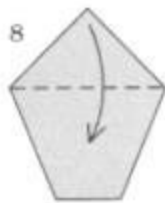

Turn over.



Place your finger inside to open the cup.



Cup

Hat

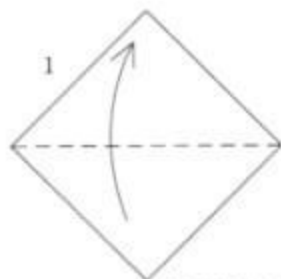

Fold in half.



Fold the corners up.

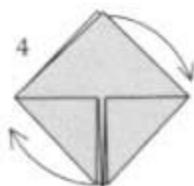
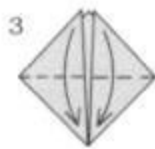

Rotate.

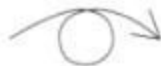
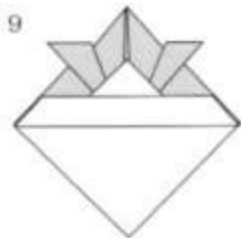
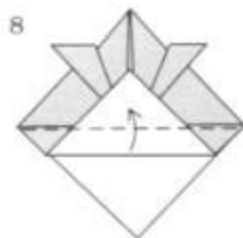
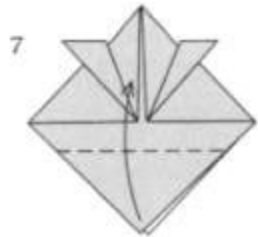
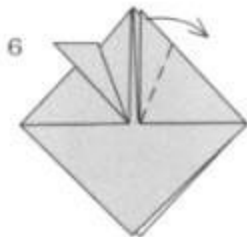
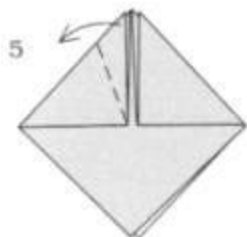

Turn over.

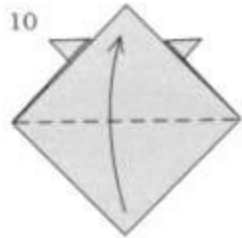

Turn over.

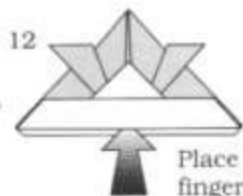

Place your
finger inside to
open the hat.

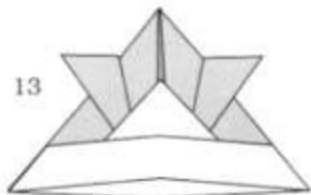

Hat

Tall Cap

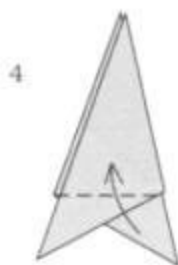
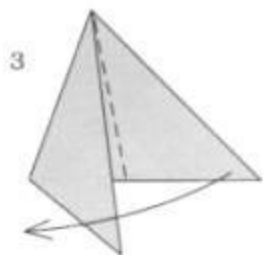
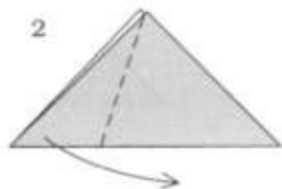
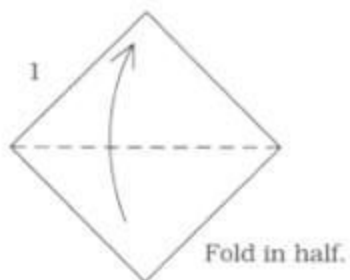

Place your finger inside.

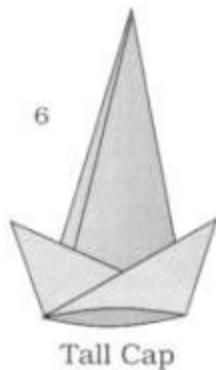

Boat

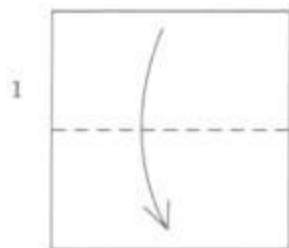

Fold in half.

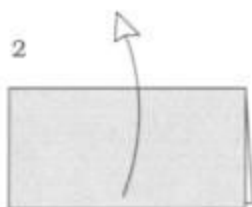

Unfold.

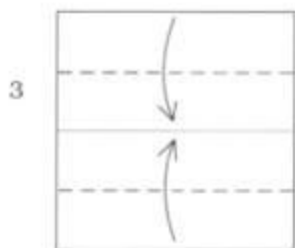

Fold to the center.

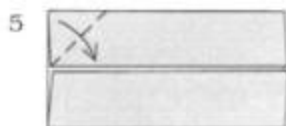

Fold a corner towards the center.



Fold the other corners towards the center.



Fold to the center.



Open up to see the white paper.



Fold inside-out and turn over.

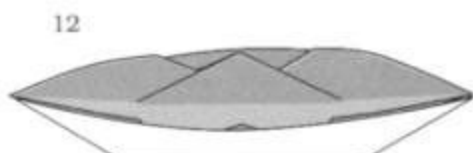

Boat

House

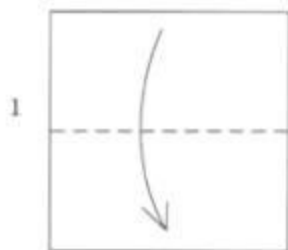

Fold in half.



Fold in half.

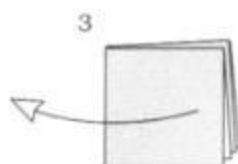

Unfold.

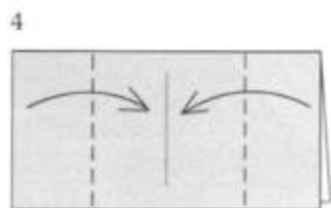

Fold to the center.

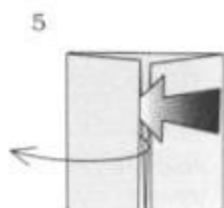

Place your finger inside to open.

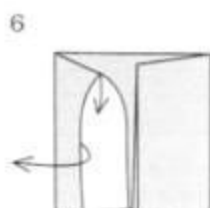

Continue opening the model.

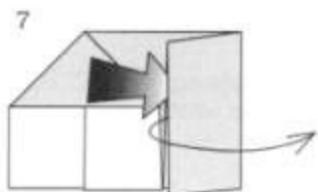

Open the right side.

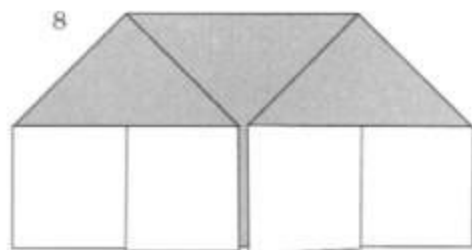

House

Piano

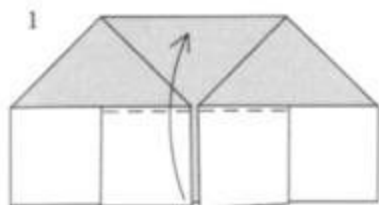

Begin with the house.

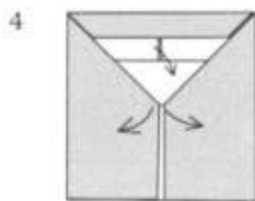
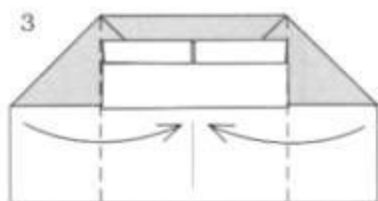
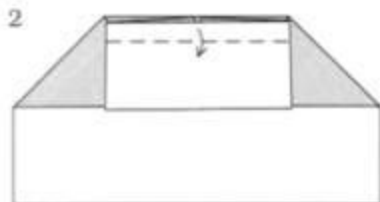

Open.

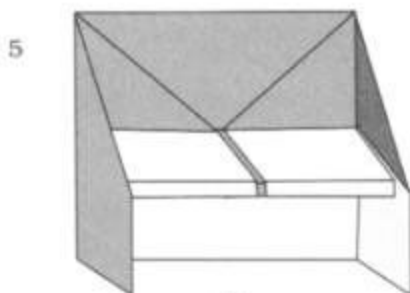

Piano

Oblong Box

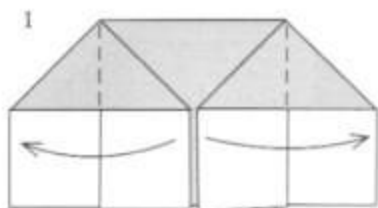

Begin with the house.

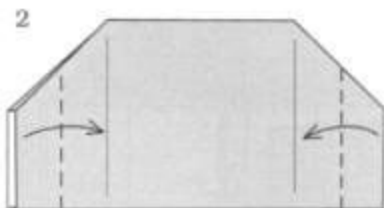

Fold behind.

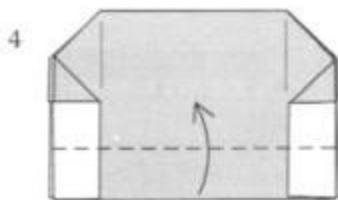

Repeat behind.

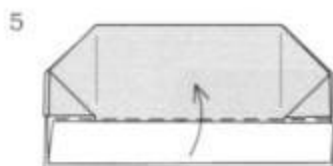

Repeat behind.

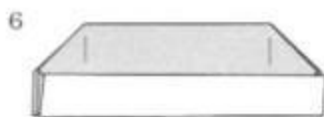

Rotate.

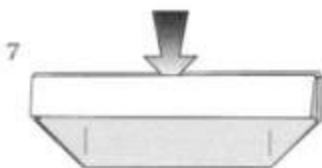

Open the box.



Oblong Box

Fox



Begin with the house.



Turn over.

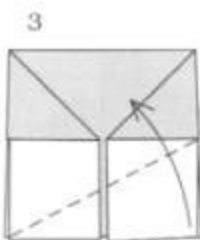
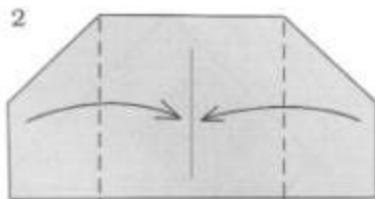

Fold up, repeat behind.

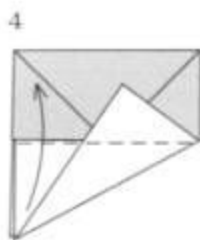

Fold up, repeat behind.

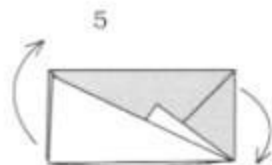

Rotate.

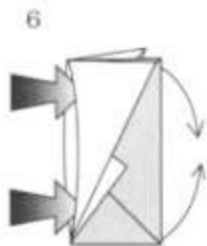

Place your finger and thumb inside to shape the mouth.



Fox

Sitting Fox

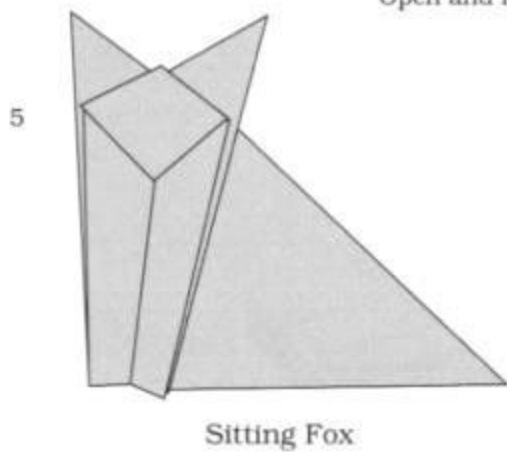
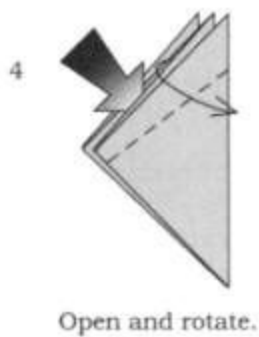
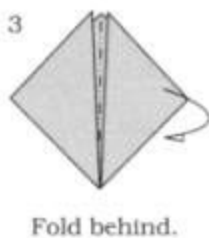
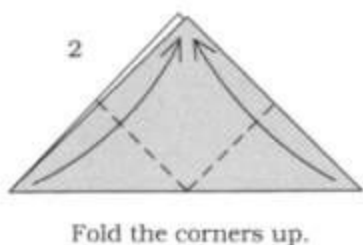
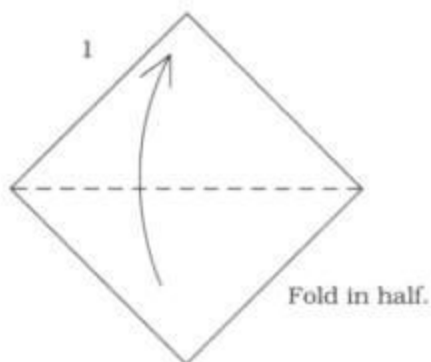

Cicada

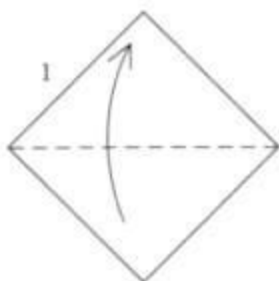

Fold in half.



Fold the corners up.

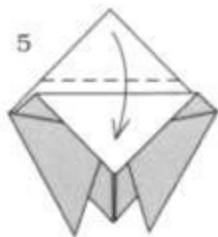
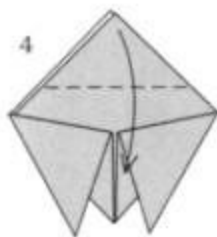
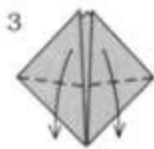

Fold behind.

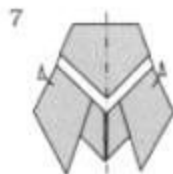

Bend in half.



Cicada

Pigeon

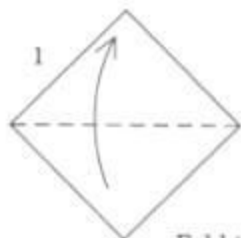

Fold in half.



Fold in half.



Unfold.



Turn over.

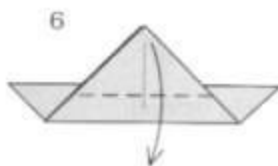

Fold one layer down.

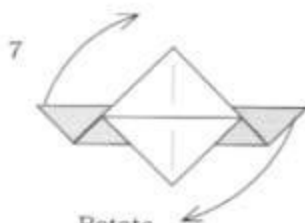

Rotate.

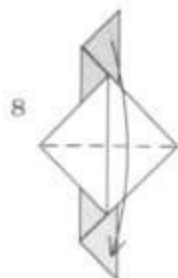

Fold in half.

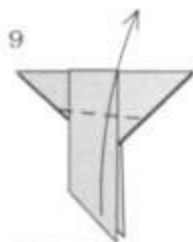

Fold the wing up,
repeat behind.

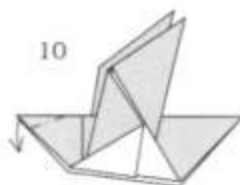

Fold the beak.

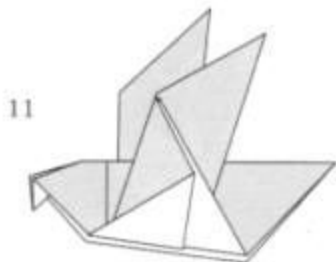

Pigeon

Pelican

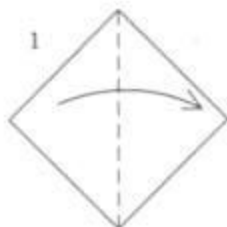

Fold in half.

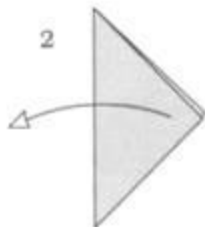

Unfold.

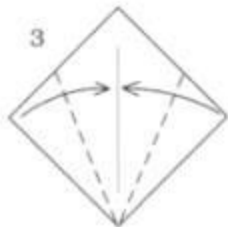

Fold to the center.

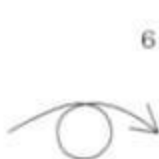

Turn over.



Fold the bottom tip above the top.

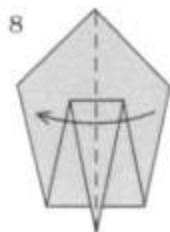

Fold in half and rotate.



Slide out the neck and head.



Fold the tail up.



Repeat behind.

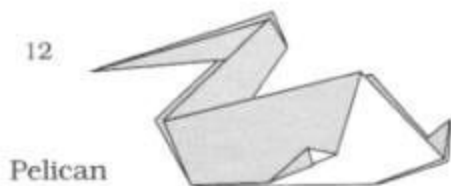

Pelican

Pin Wheel

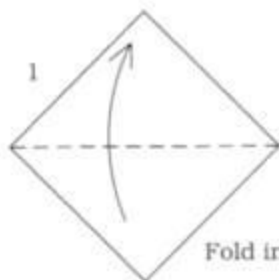

Fold in half.

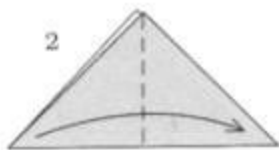

Fold in half.

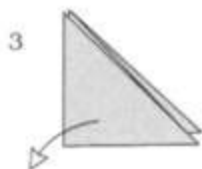

Unfold everything.

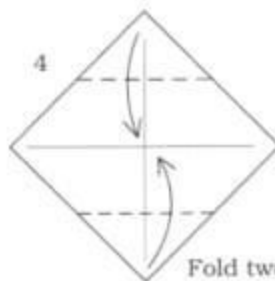

Fold two corners to the center.



Turn over.

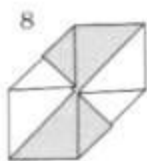

Turn over.

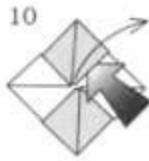

Place your finger inside to pop out the corner.



Pop out the lower corner.

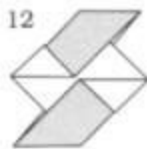

Turn over.

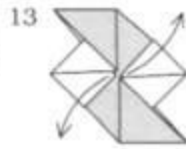

Pull out the white corners.

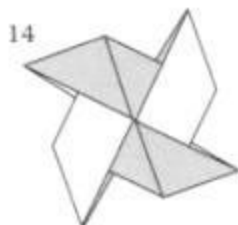

Pin Wheel

Lantern

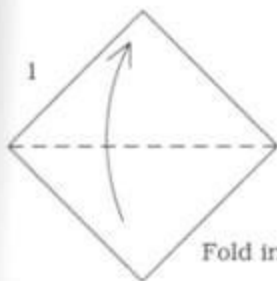

Fold in half.

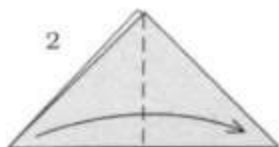

Fold in half.

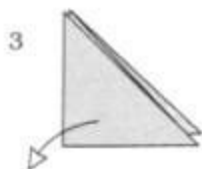

Unfold everything.

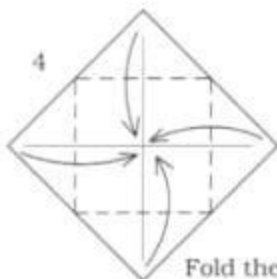

Fold the corners to the center.



Turn over and rotate.

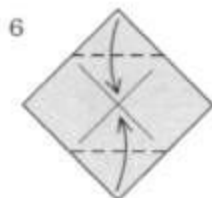

Fold the top and bottom to the center.



Turn over.

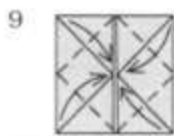

Fold the corners to the center.

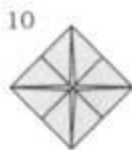

Turn over.

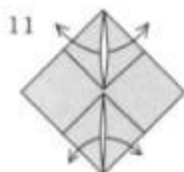

Open the top and bottom.

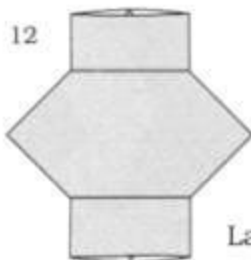

Lantern

Swan

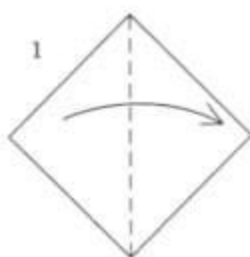

Fold in half.

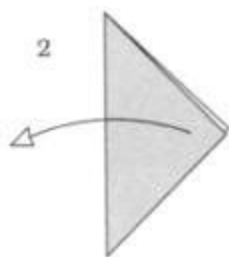

Unfold.

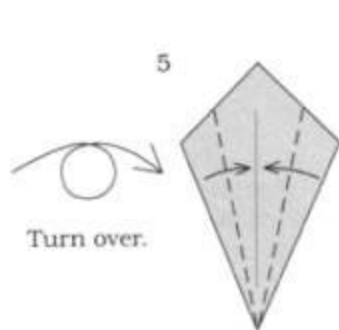
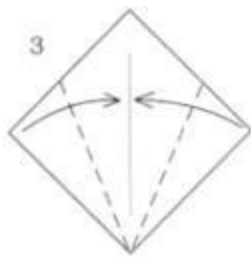

Turn over.

Fold to the center.

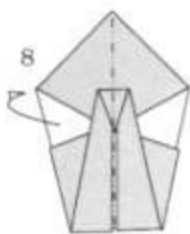
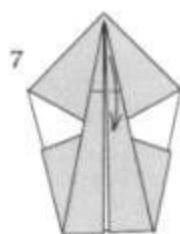

Fold behind.

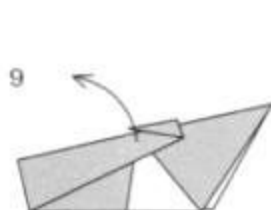

Slide the neck up.

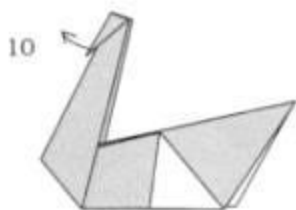

Slide the head up.

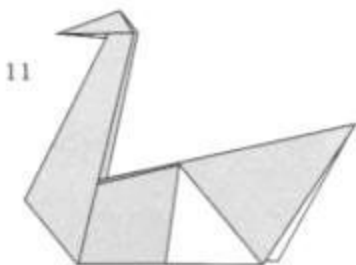

Swan

1

Star

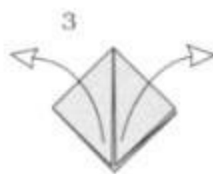
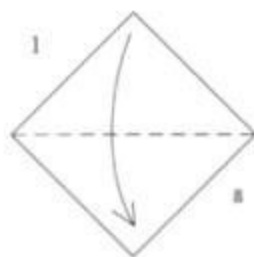

Unfold.



Fold in half.

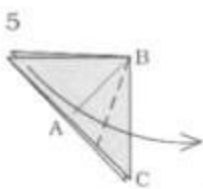

Fold A to the line B-C.

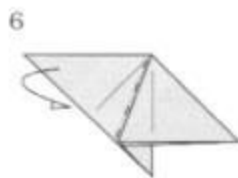

Fold behind.

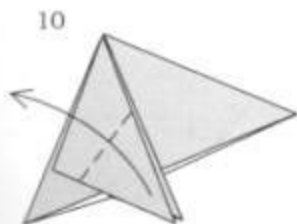
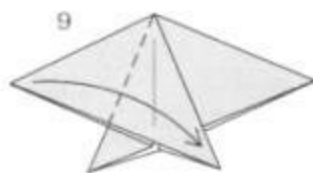
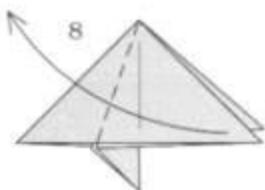
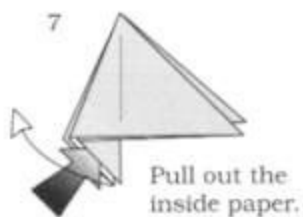

There are no guide lines for this fold.

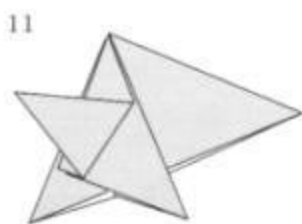

Repeat steps 9 and 10 behind.



Star

Sailboat

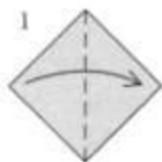

1 Fold in half.

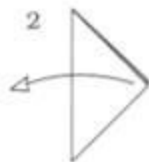

2 Unfold.

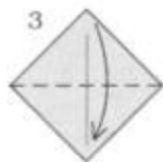

3 Fold in half.

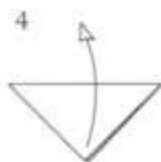

4 Unfold.



Turn over.

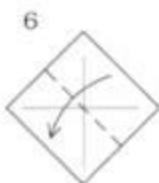

6 Book-fold.



7 Unfold.

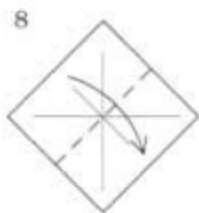

8 Book-fold.

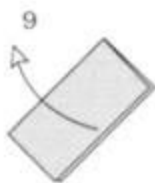

9 Unfold.

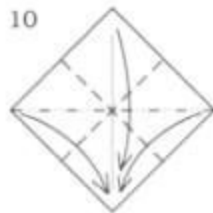

10 Collapse along the creases so that all the corners meet.

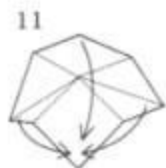

11 This is a three-dimensional intermediate step.



12 Fold inside.



13 Turn over.



Fold inside.



Rotate.

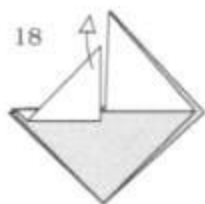
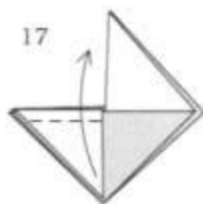
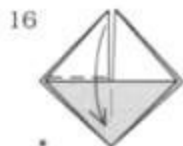

Unfold.



Refold while tucking inside.

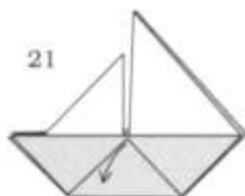
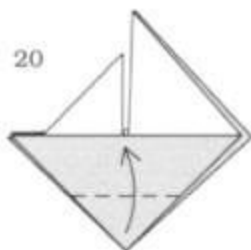

Fold the triangle
down a little so the
sailboat can stand.



Turn over.

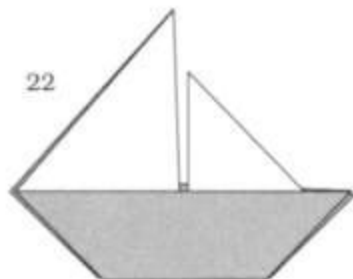

Sailboat

This sailboat is the logo for
*The Friends of The Origami
Center of America.*

Carp

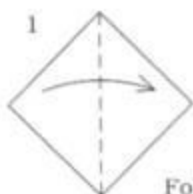

Fold in half.

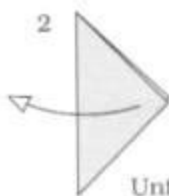

Unfold.

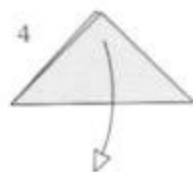
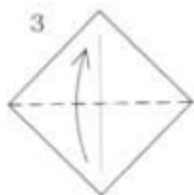

Unfold.

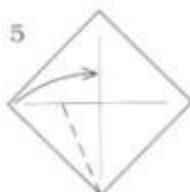

Kite-fold but only crease below the center line.

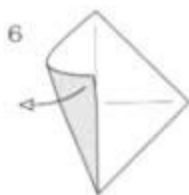

Unfold.

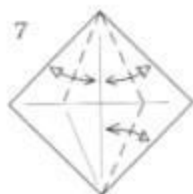

Fold and unfold three other sides.

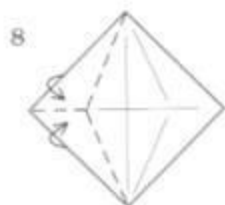

This is a three-dimensional drawing.

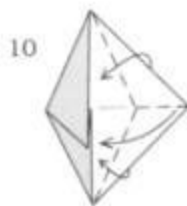

Repeat steps 8 and 9 on the right.



Turn over.



13



14



15



Slide out the point.

16

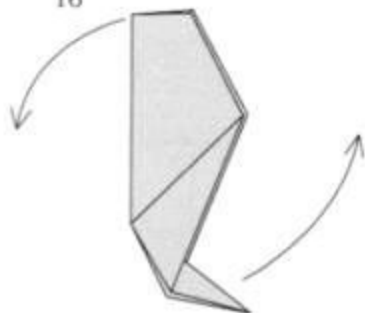

Rotate.

17

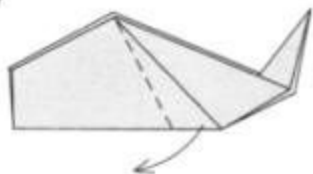

Fold the fin down, repeat behind.

18

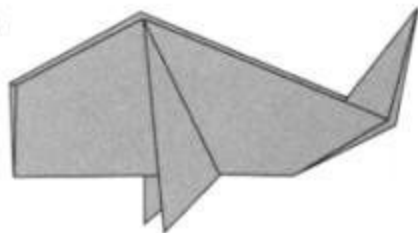

Carp

Butterfly



Fold in half.

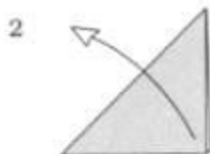

Unfold.

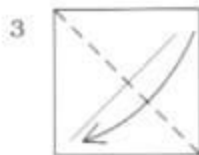

Fold in half.

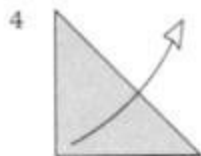

Unfold.



Turn over.



Fold the corners to the center.

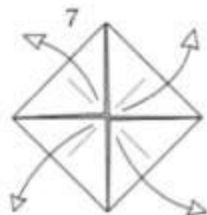

Unfold.



Turn over.

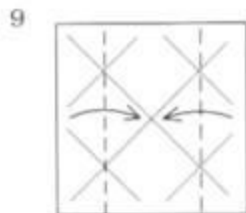

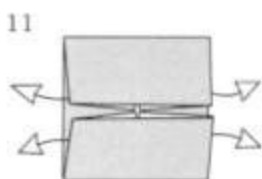
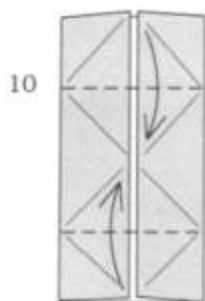

Pull out the corners.

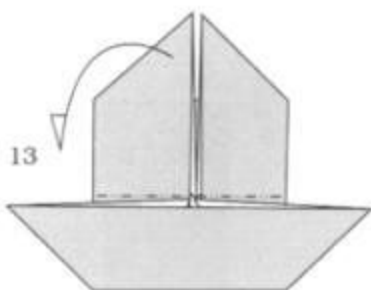
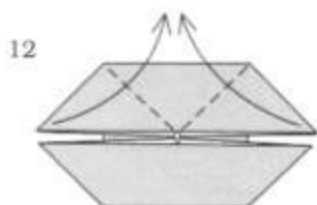

Fold behind.

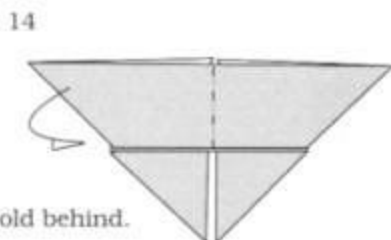

Fold behind.

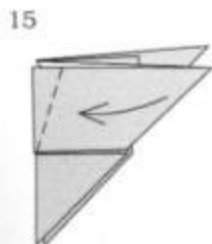

Repeat behind.

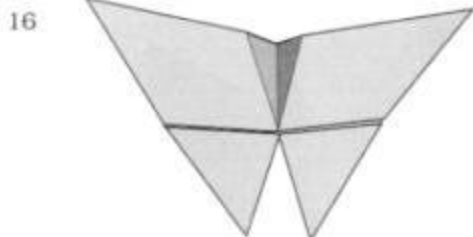

Butterfly

Frog

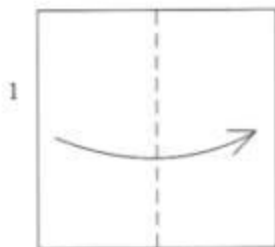

Fold in half.

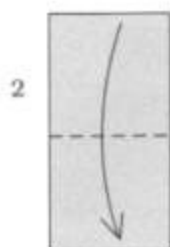

Fold in half.

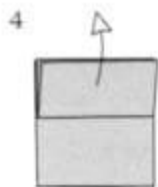
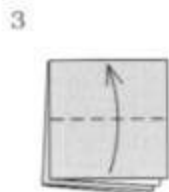

Unfold.

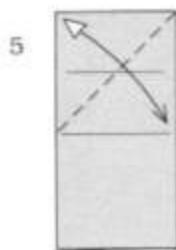

Fold and unfold.



Fold and unfold.

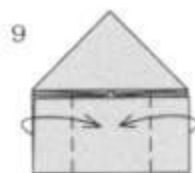
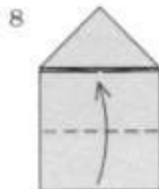
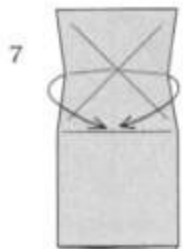

10



11



12

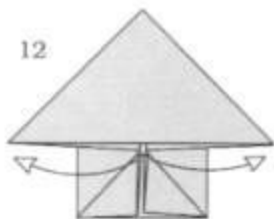

Pull out the corners.

13

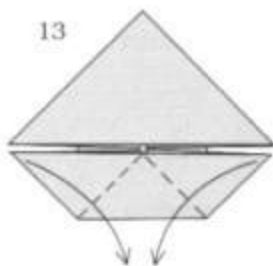

14

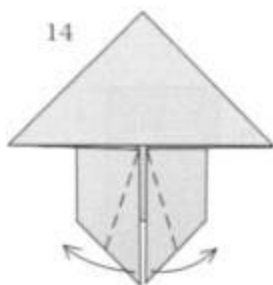

15

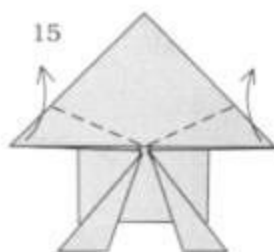

16

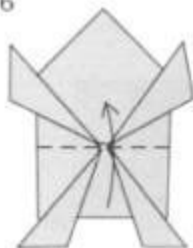

17

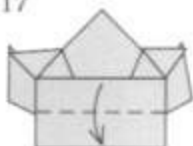

Turn over.

18

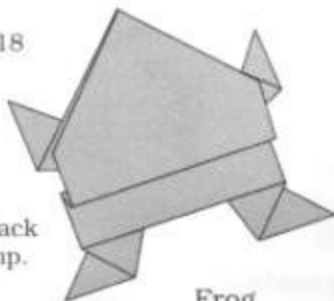

Push down on the back
and the frog will jump.

Frog

Pig

1

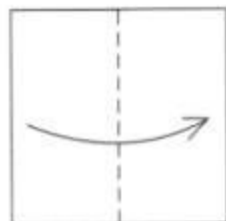

Fold in half.

2

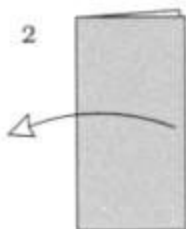

Unfold.

3

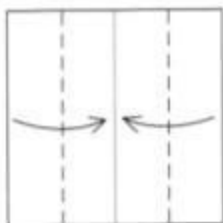

Fold to the center.

4



Turn over.

5



6



Unfold.

7



8



9



10



Unfold.

11



Place your finger inside to pull out the corner.

12



Pull out the three other corners.

13



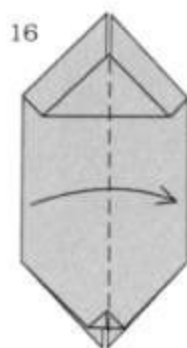
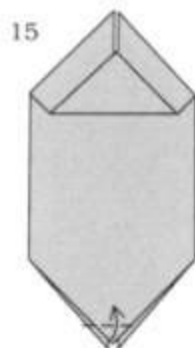
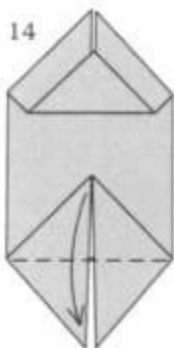

Fold in half.

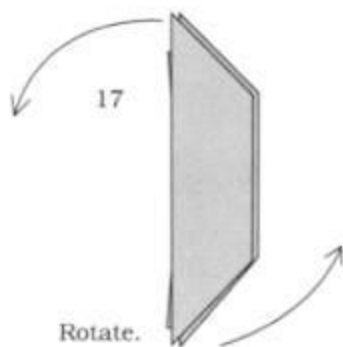

Repeat behind.



Fold the legs down,
repeat behind.

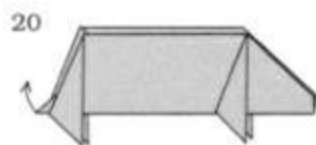

Slide the tail up.

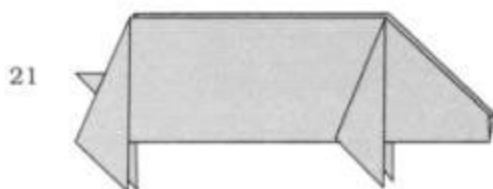

Pig

Waterbomb

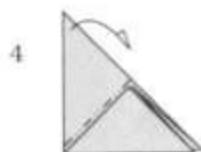
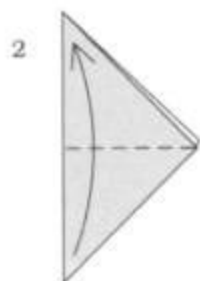
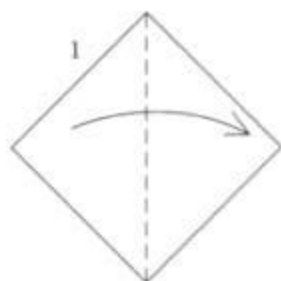

Fold behind.



Pull out the middle layer.



Rotate.



Fold the corners up,
repeat behind.

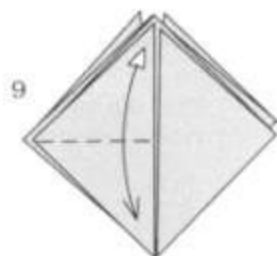

Fold one layer
down and unfold.

10

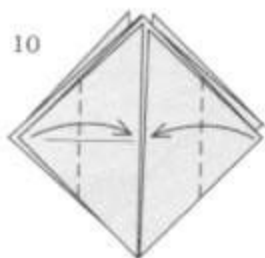

Fold to the center,
repeat behind.

11



Fold to the center,
repeat behind.

12



Repeat behind.

13



Unfold, repeat behind.

14



Tuck inside the pockets,
repeat behind.

15



Blow into the bottom.

16



Waterbomb

Candy Box

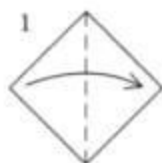

Fold in half.

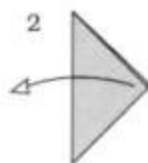

Unfold.

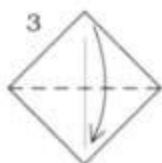

Fold in half.

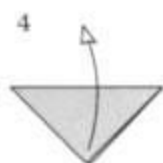

Unfold.

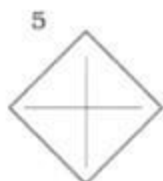

Turn over.

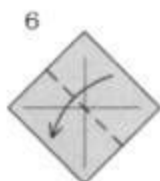

Book-fold.



Unfold.

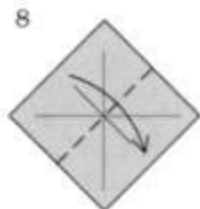

Book-fold.

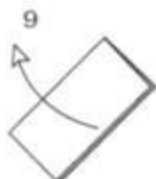

Unfold.

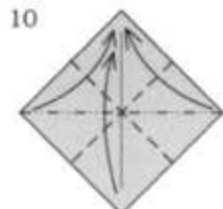

Collapse along the creases so that all the corners meet.



This is a three-dimensional intermediate step.



Repeat behind.



Unfold, repeat behind.

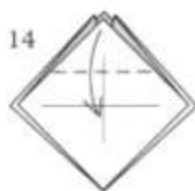

Repeat behind.

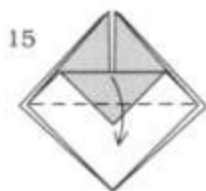

Repeat behind.

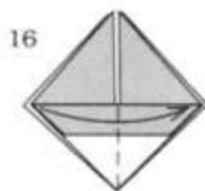

Repeat behind.

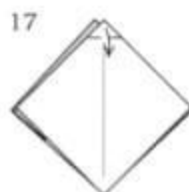

Fold the tip down,
repeat behind.

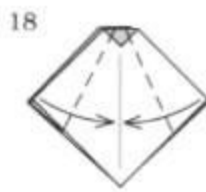

Kite-fold,
repeat behind.

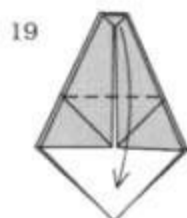

Repeat behind.



Tuck inside,
repeat behind.



Open the box.

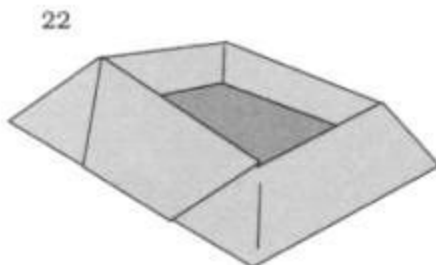

Candy Box

Fancy Box

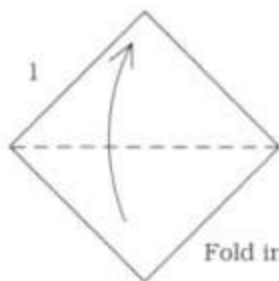

Fold in half.

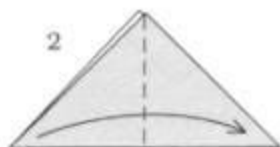

Fold in half.

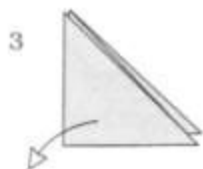

Unfold everything.

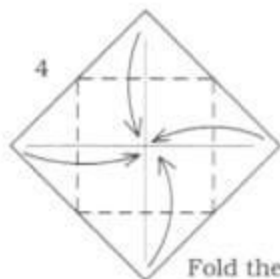

Fold the corners to the center.



Turn over.

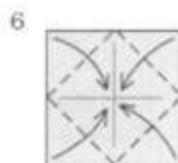

Fold the corners to the center.

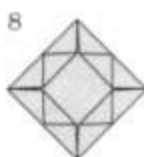

Turn over.

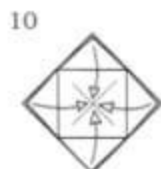
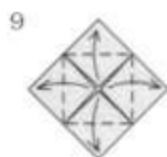

Unfold.

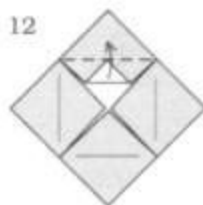
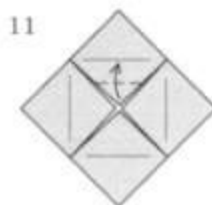

13

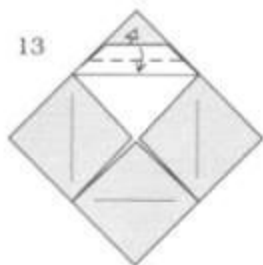

14

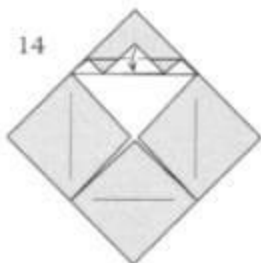

Let the corner slide out.

15

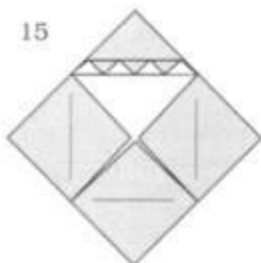

Repeat steps 11-14
on the three sides.

16

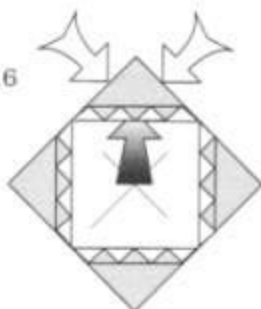

Place your finger inside and
push from the outside.
Repeat for each side.

17

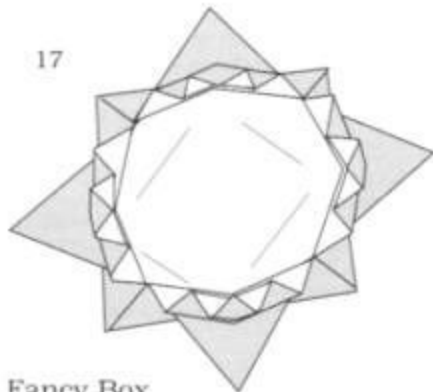

Fancy Box



DOVER BOOKS ON PAPER-CRAFT, ORIGAMI

- PAPER TOY MAKING, Margaret W. Campbell. (21662-4) \$3.95
EASY-TO-CUT HOLIDAY SILHOUETTES, Betty Christy. (26628-1) \$3.50
EASY-TO-CUT SILHOUETTE DESIGNS, Betty Christy. (25061-X) \$4.95
MARBLEIZED PAPER PATTERNS IN FULL COLOR, Lauren Clark. (27220-6) \$9.95
OLD-FASHIONED VIGNETTES IN FULL COLOR, Carol Belanger Grafton. (25625-1)
\$5.95
OLD-TIME VIGNETTES IN FULL COLOR, Carol Belanger Grafton. (27269-9)
\$5.95
CREATIVE PAPER TOYS AND CRAFTS, Michael Grater. (24184-X) \$6.95
MAKE IT IN PAPER, Michael Grater. (24468-7) \$4.95
TECHNIQUES FOR MARBLEIZING PAPER, Gabriele Grünebaum. (27156-0) \$2.95
ART NOUVEAU DECORATIVE PAPERS, Muncie Hendler. (24446-6) \$5.95
EARLY AMERICAN DECORATIVE PAPERS, Muncie Hendler. (23937-3) \$4.95
VICTORIAN DECORATIVE PAPERS, Muncie Hendler. (23885-7) \$5.95
EASY-TO-MAKE DECORATIVE BOXES AND DESK ACCESSORIES, Annette Hollander.
(25183-7) \$5.95
PAPERMAKING, Dard Hunter. (23619-6) \$13.95
EASY-TO-CUT MOTHER GOOSE SILHOUETTES, Florence Leniston. (26450-5)
\$2.95
THE CORNUCOPIA OF DESIGN AND ILLUSTRATIONS FOR DECOUPAGE AND OTHER ARTS
AND CRAFTS, Eleanor Hasbrouck Rawlings. (23795-8) \$8.95
GEOMETRIC EXERCISES IN PAPER FOLDING, T. Sundara Row. (21594-6) \$4.95
READY-TO-USE MARBLEIZED PAPERS, Judith B. Saurman & Judith A. Pierce.
(23901-2) \$5.95
FUN WITH EASY ORIGAMI, Dover. (27480-2) \$4.95
FUN WITH ORIGAMI, Dover. (26664-8) \$3.95
LARGE ORIGAMI PAPER, Dover. (27295-8) \$4.95
ORIGAMI PAPER, Dover. (26829-2) \$2.95
HOW TO MAKE ORIGAMI AIRPLANES THAT FLY, Geri Hsu. (27352-0) \$5.95
THE COMPLETE BOOK OF ORIGAMI, Robert J. Lang. (25837-8) \$8.95
AFRICAN ANIMALS IN ORIGAMI, John Montroll. (26977-9) \$9.95
ANIMAL ORIGAMI, John Montroll. (24792-9) \$8.95
EASY ORIGAMI, John Montroll. (27298-2)

Paperbound unless otherwise indicated. Prices subject to change without notice. Available at your book dealer or write for free catalogues to Dept. 23, Dover Publications, Inc., 31 East 2nd Street, Mineola, N.Y. 11501. Please indicate field of interest. Each year Dover publishes over 200 books on fine art, music, crafts and needlework, antiques, languages, literature, children's books, chess, cookery, nature, anthropology, science, mathematics, and other areas.

Manufactured in the U.S.A.

EASY ORIGAMI

John Montroll

Here is a collection of 32 simple projects for novice origami hobbyists—clearly illustrated and with easy-to-follow instructions that even beginning paper crafters can follow with success. Subjects range from an ultra-simple hat, cup and pinwheel to the more challenging (but still un-intimidating) penguin, pelican and piano.

Also included are the figures of a swan, lantern, cicada, pigeon, fox, rabbit and twenty other popular origami subjects. With the successful completion of these projects, origami hobbyists will be well on their way to mastering a fascinating art that's as old as the invention of paper itself.

Original Dover (1992) publication. Introduction. Contents. Symbols. Instructions. 365 illustrations. 48pp. 8 1/2" x 11". Paperbound.

ALSO AVAILABLE

FUN WITH ORIGAMI: 17 EASY-TO-DO PROJECTS AND 24 SHEETS OF ORIGAMI PAPER, Dover. 9 x 12. 26664-8 Pa. \$4.95

ORIGAMI PAPER: 24 7" x 7" SHEETS IN 12 COLORS, Dover. 9 1/2" x 12 1/2". 26829-2 Pa. \$3.95

AFRICAN ANIMALS IN ORIGAMI, John Montroll. 160pp. 7 x 10. 26977-9 Pa. \$9.95

ANIMAL ORIGAMI FOR THE ENTHUSIAST, John Montroll. 128pp. 9 x 12. 24792-9 Pa. \$8.95

ORIGAMI SEA LIFE, John Montroll and Robert J. Lang. 256pp. 7 x 10. 26765-2 Pa. \$10.95

PREHISTORIC ORIGAMI: DINOSAURS AND OTHER CREATURES, John Montroll. 143pp. 6 1/2" x 9 1/2". 26588-9 Pa. \$9.95

ORIGAMI FOR THE ENTHUSIAST, John Montroll. 128pp. 9 x 12. 23799-0 Pa. \$8.95

ORIGAMI SCULPTURES, John Montroll. 144pp. 6 1/2" x 9 1/2". 26587-0 Pa. \$9.95

THE COMPLETE BOOK OF ORIGAMI: STEP-BY-STEP INSTRUCTIONS IN OVER 1,000 DIAGRAMS/48 ORIGINAL MODELS, Robert J. Lang. 160pp. 9 x 12. 25837-8 Pa. \$8.95

SECRETS OF ORIGAMI: THE JAPANESE ART OF PAPER FOLDING, Robert Harbin. 272pp. 8 1/2" x 11". 29707-1 Pa. \$12.95

MODERN ORIGAMI, Dr. James Minoru Sakoda. 160pp. 8 1/2" x 10 1/2". 29843-4 Pa. \$9.95

ANIMAL PRINTS ORIGAMI PAPER, Dover. 9 1/2" x 12 1/2" shrink-wrapped folder. 40029-8 \$4.50

RAINBOW PATTERNED ORIGAMI PAPERS, Dover. 29864-7 \$4.50

Free Dover Crafts, Needlework & Cooking Catalog (59111-5) available upon request.

Cover design by Frank J. Moore

ISBN 0-486-27298-2



•3.50 IN USA

9 780486 272986

Montroll EASY ORIGAMI Dover 0-486-27298-2

Valentine

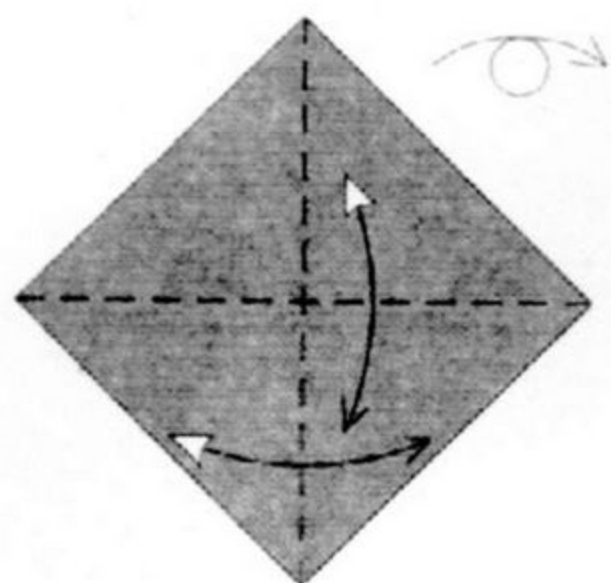

1. Begin with a square, colored side up. Fold and unfold along the diagonals. Then turn the paper over.

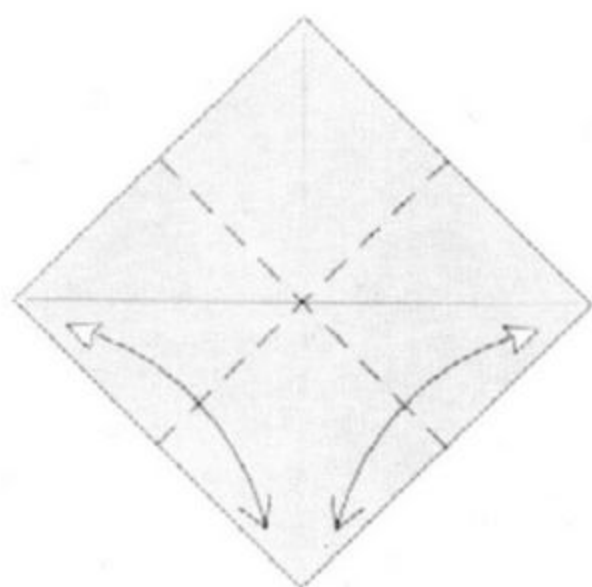
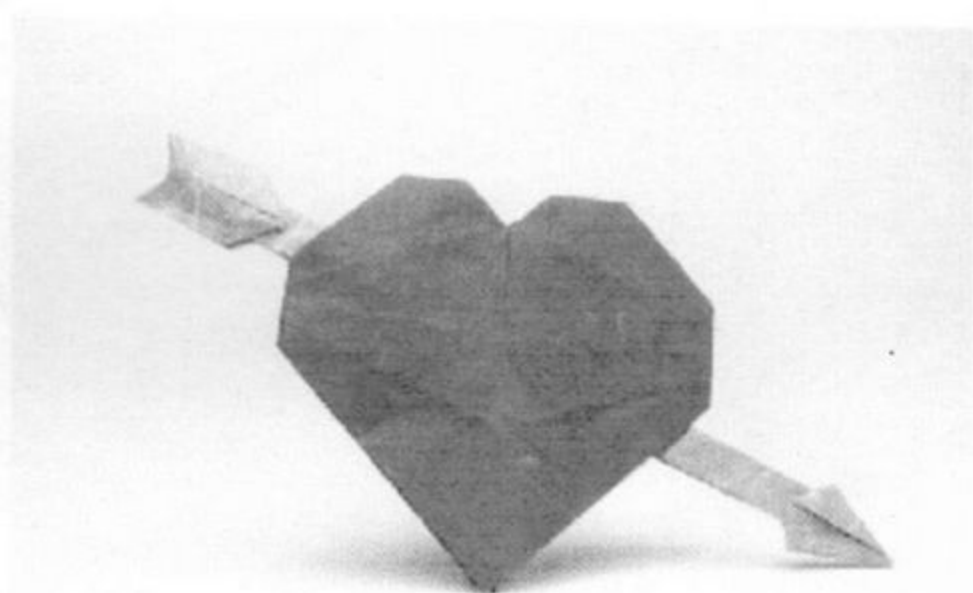

2. Fold the paper in half from edge to edge and unfold. Repeat the other direction.

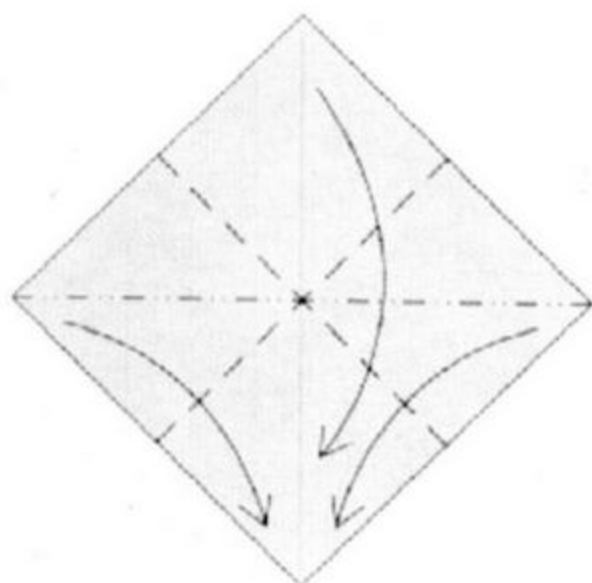

3. Bring all four corners together at the bottom, forming a Preliminary Fold.

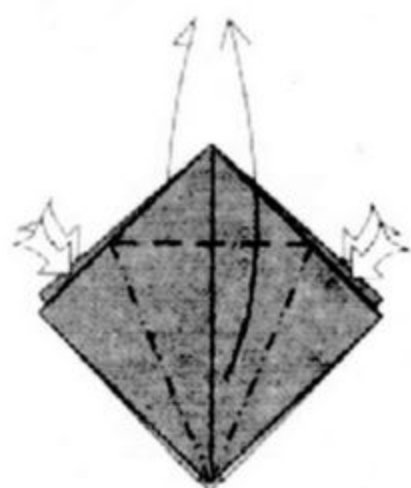

4. Petal-fold the front and back flaps to form a Bird Base.

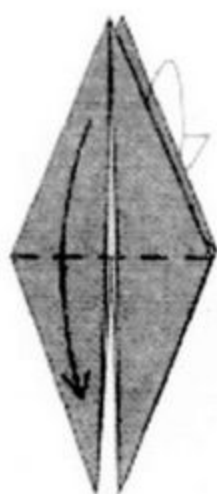

5. Fold one flap down in front and one behind.



6. Fold one flap to the right in front and one to the left behind.



7. Fold one flap up in front and back down. Repeat behind.

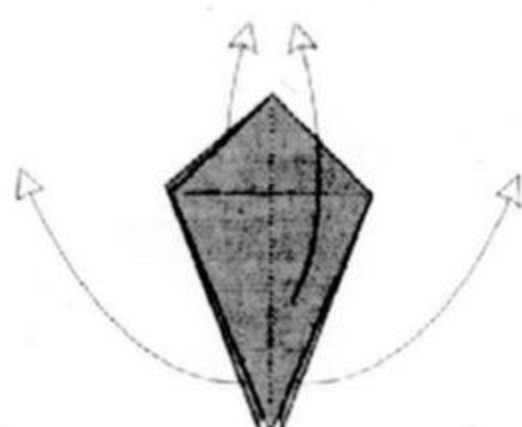

8. Unfold the model completely.

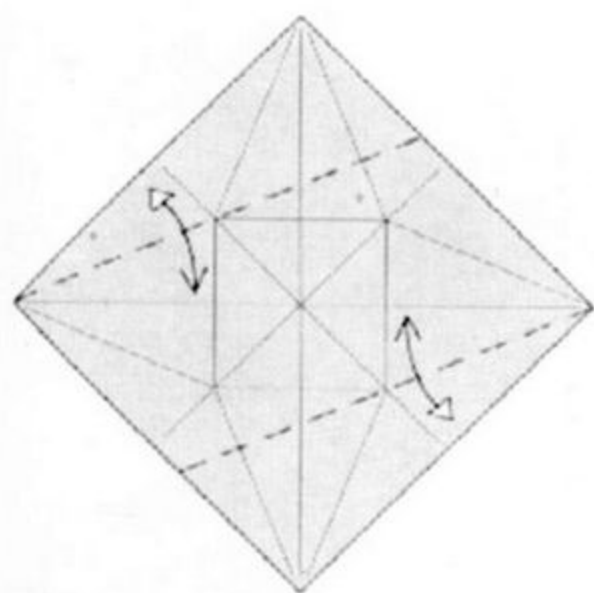

9. Extend an existing crease to the lower left edge. Repeat above.

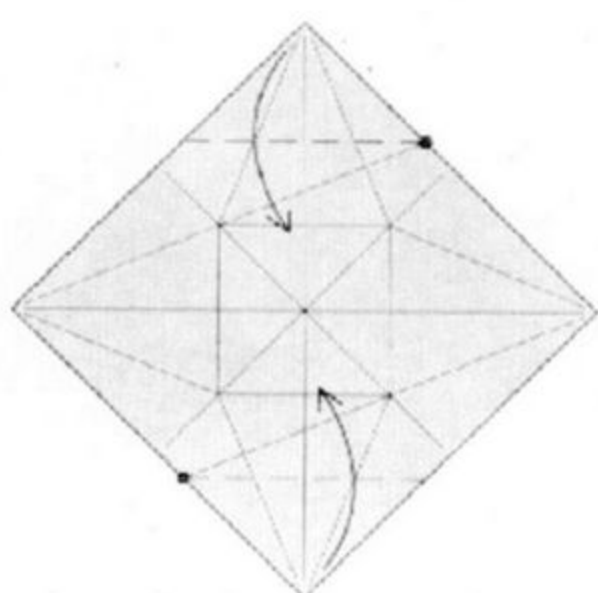

10. Fold the bottom corner up; the crease hits the edge at the same place as the last crease. Repeat with the top corner.

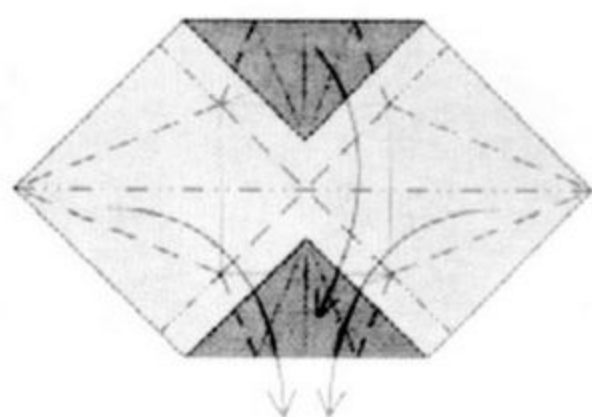

11. Refold the Bird Base, using the existing creases (although you will have to make new creases through the colored corners).

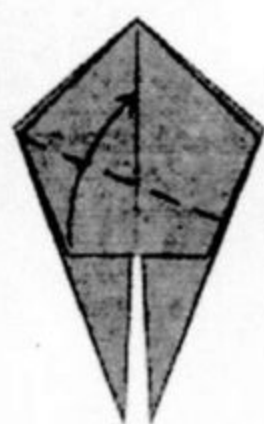

12. Fold the bottom left corner up to the center line; the fold runs along an existing crease. You don't need to make this fold sharp.

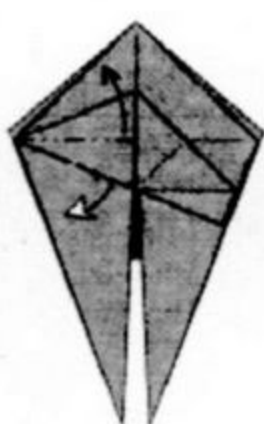

13. Shift some paper upward as far as possible, releasing the trapped paper underneath the flap.



14. Squash-fold the corner, swinging the excess paper over to the left.



15. As you did in step 13, shift some paper upward, releasing the trapped paper underneath.



16. Bring a raw edge in front of the flap.

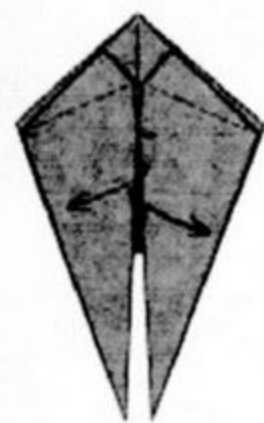

17. Open out the raw edges slightly.

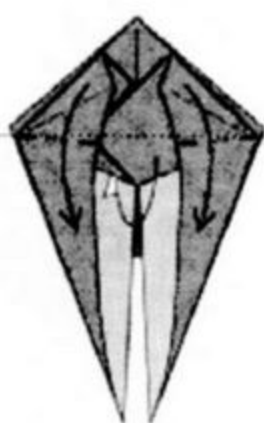

18. Fold the two top near flaps downward while folding the blunt interior flap underneath. Close the model and flatten firmly.

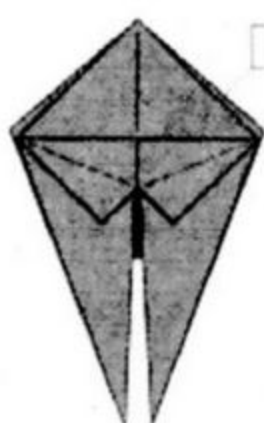

19. Repeat steps 12-19 behind. Then rotate the model 1/2 turn.

12-19

1/2

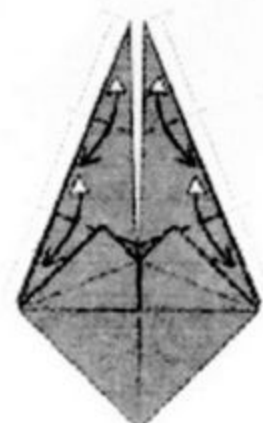

20. Divide each vertical flap into thirds with valley folds.

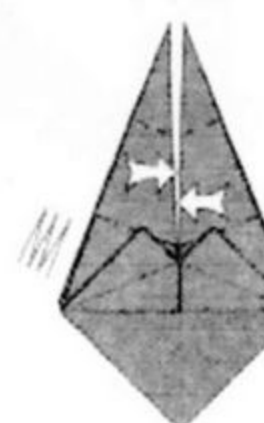

21. Reverse-fold each flap up and down on the existing creases.



22. Fold and unfold through the near layers only. Repeat behind.

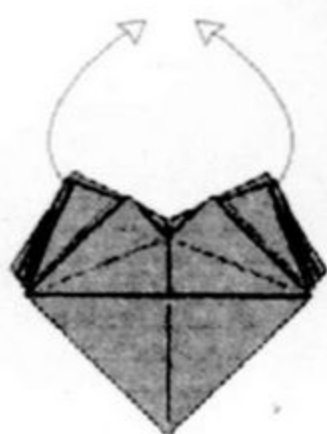

23. Unfold to step 20.

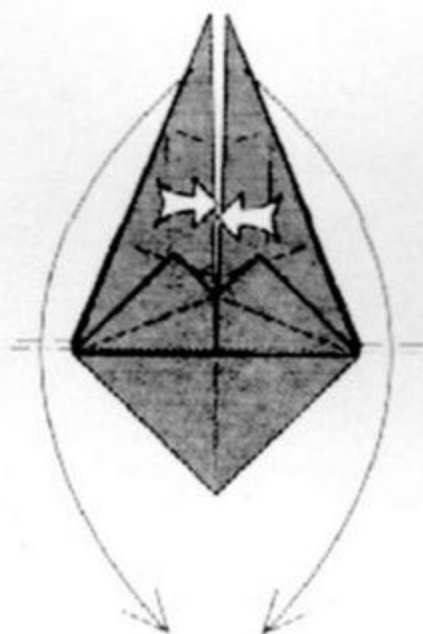

24. Reverse-fold both points as far downward as possible.

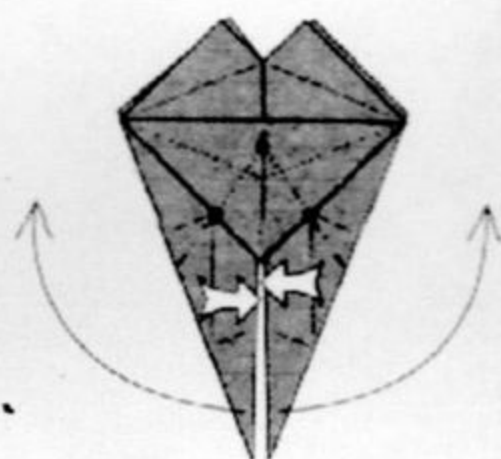

25. Reverse-fold the two points to the sides. Note the reference points for the two reverse folds.

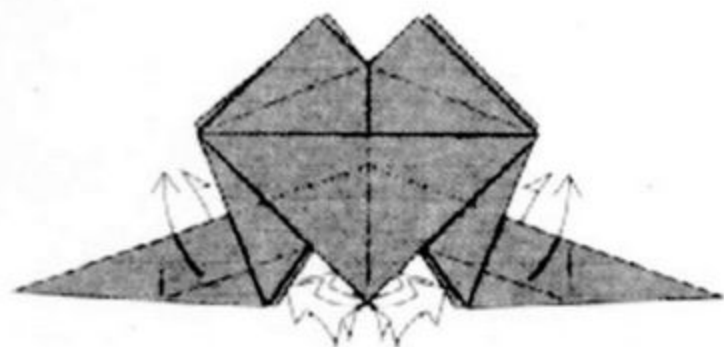

26. Reverse-fold two edges upward on each side.

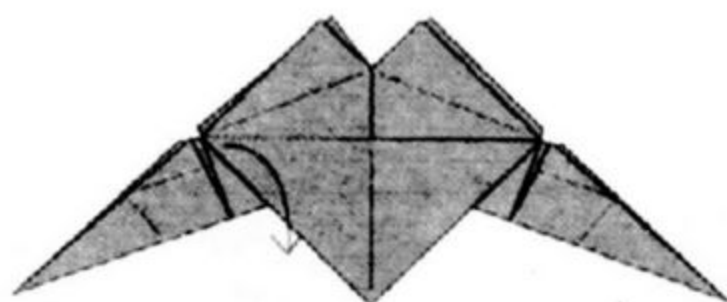

27. Partially open out the left side. The model will not lie flat.

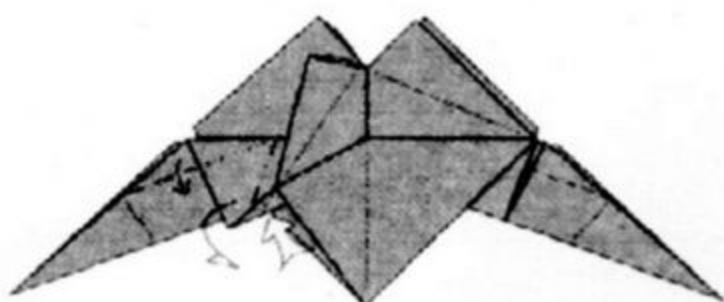

28. Valley-fold the flap on the existing crease; simultaneously flatten the interior pleat and mountain-fold its edge underneath. The model will not lie flat.

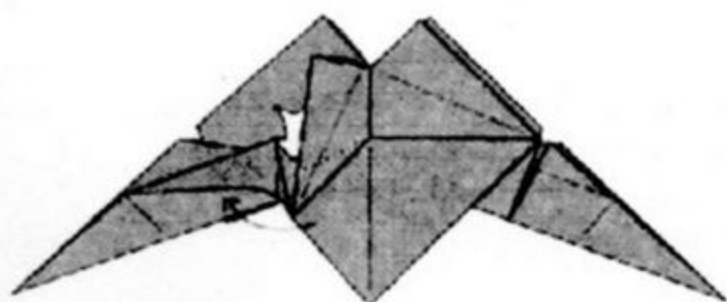

29. Push down on the triangle and close the model back up.

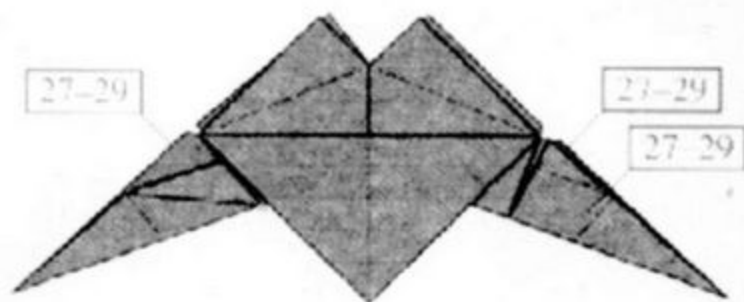

30. Repeat steps 27-29 behind and on the right.

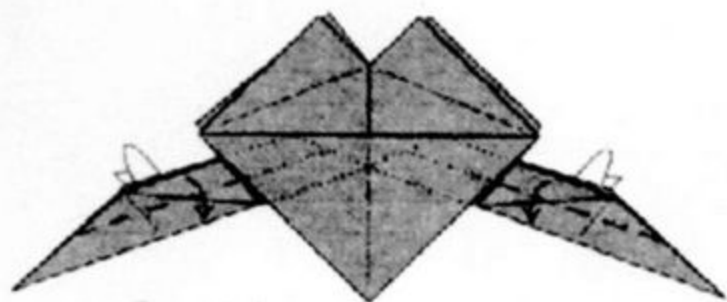

31. Valley fold the near edge of each flap. Repeat behind.

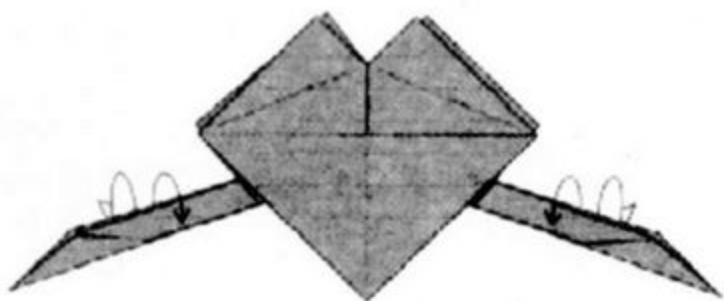

32. Wrap a raw edge from the inside of each flap to the front; repeat behind.

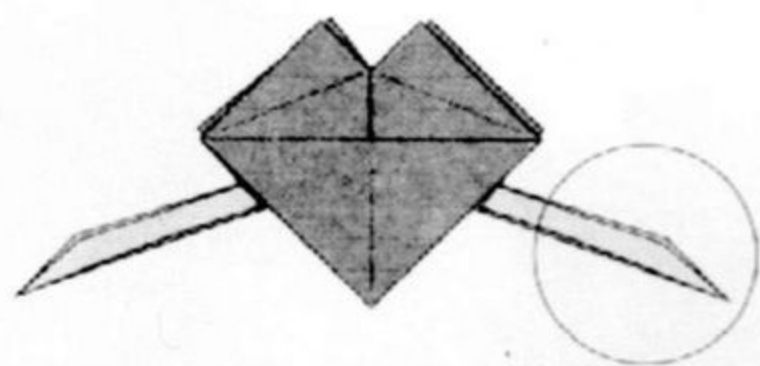

33. Steps 34–41 focus on the tips of the white flaps.

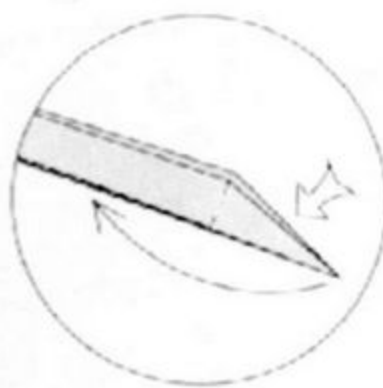

34. Double-reverse-fold the tip inside.

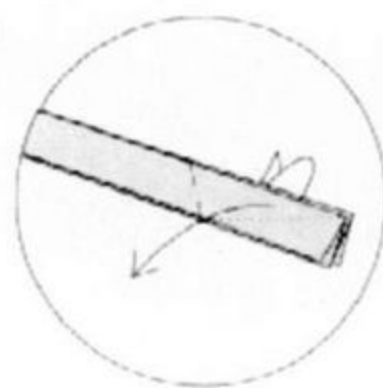

35. Outside reverse-fold the flap.

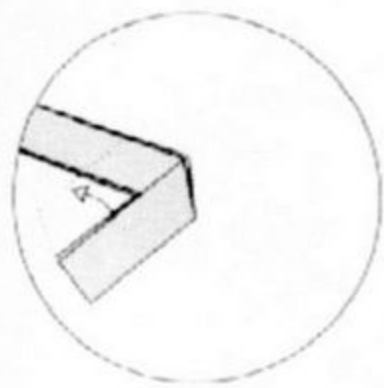

36. Pull out some loose paper.

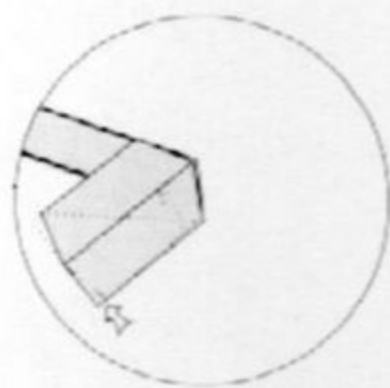

37. Shift the interior point so that its tip lies along the center line.

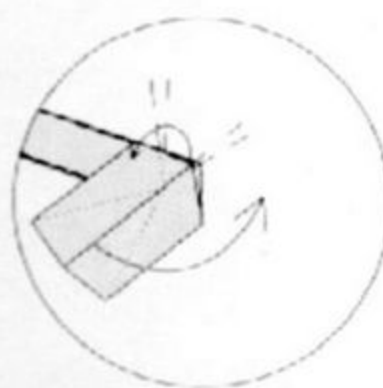

38. Crimp and rotate the end of the flap so that it aligns with the shaft emanating to the left.

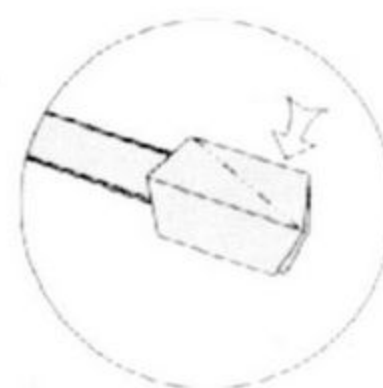

39. Closed-sink the corner.

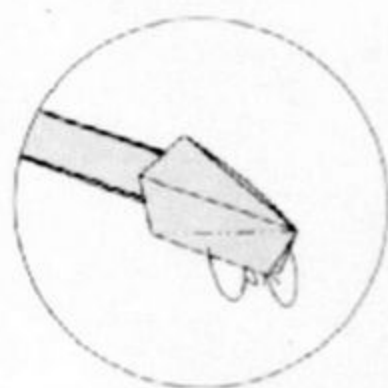

40. Mountain-fold the bottom edge underneath. Repeat behind.

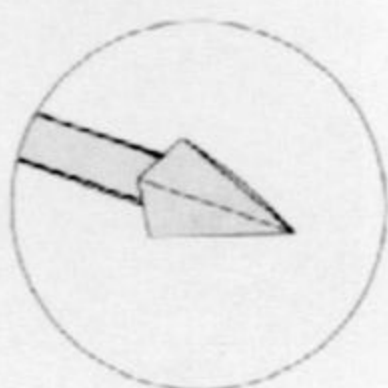

41. Like this.

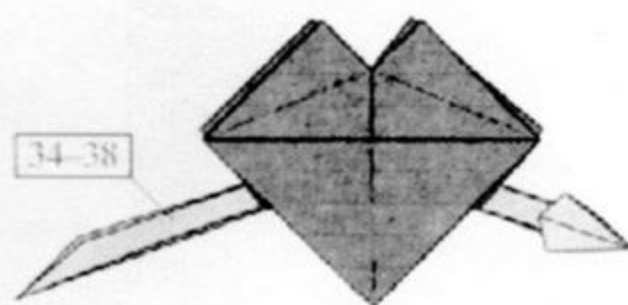

42. Repeat steps 34–38 (stop at 38!) on the right.

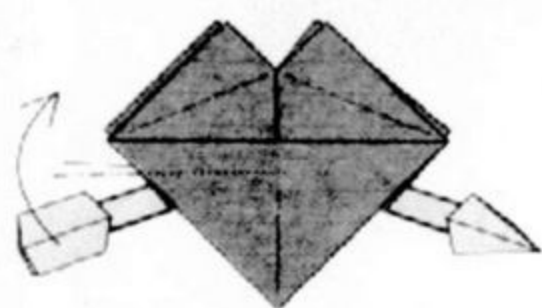

43. Crimp the left side upward so that the two halves of the white shaft line up.

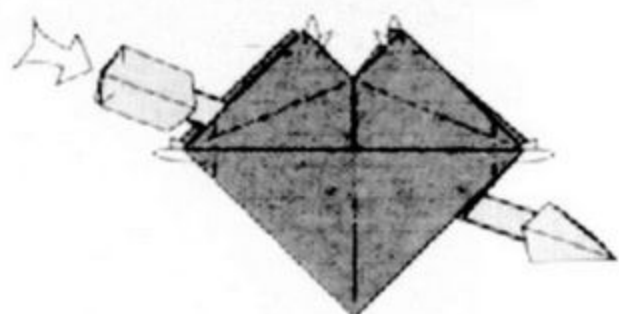

44. Round the heart with mountain folds. Dent the tail of the arrow to make it slightly three-dimensional.

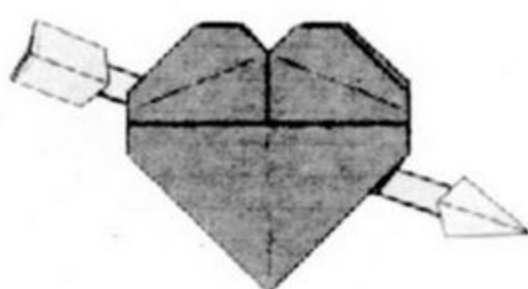

45. Finished Valentine.