

CarToon Origami 2

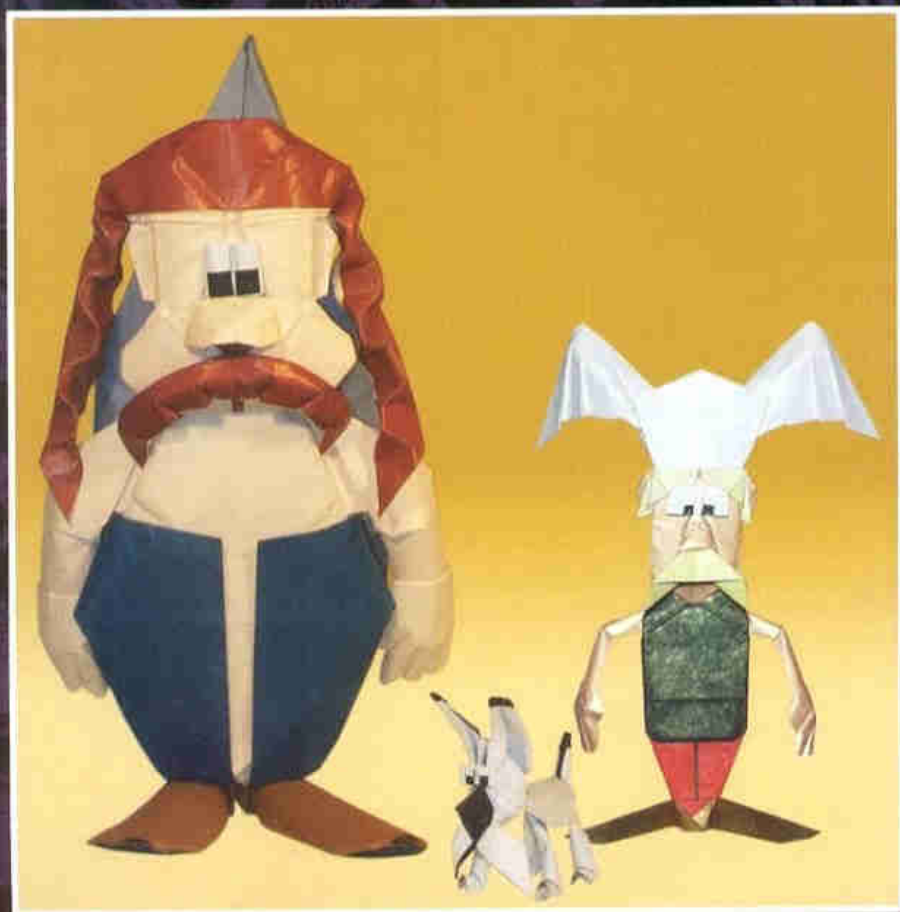

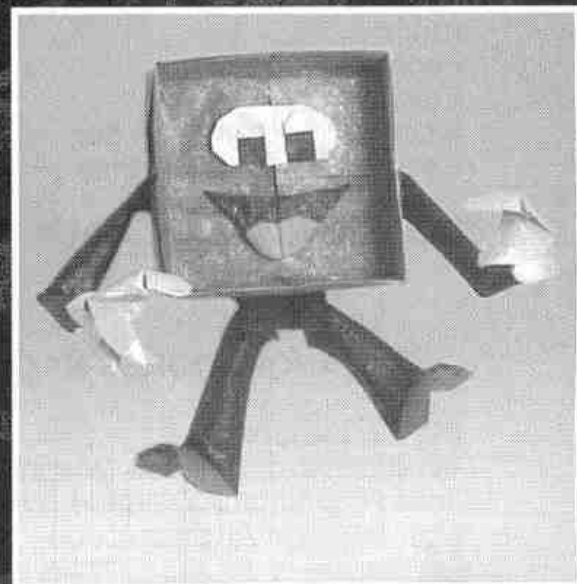

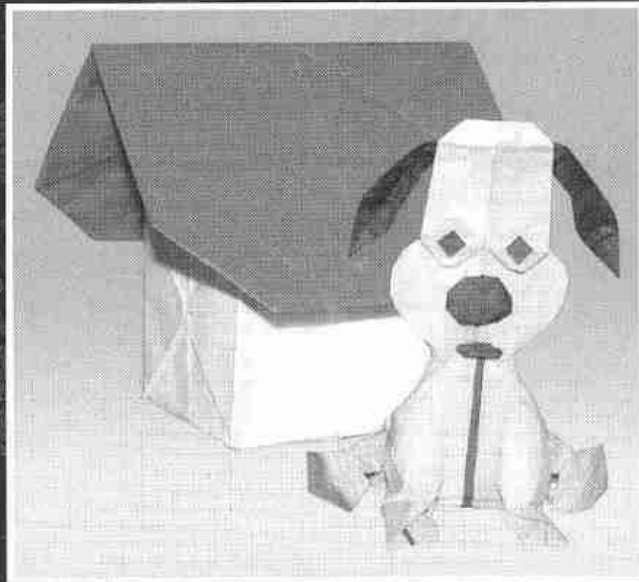
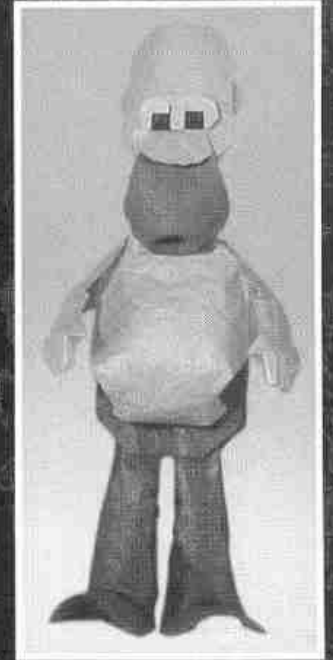
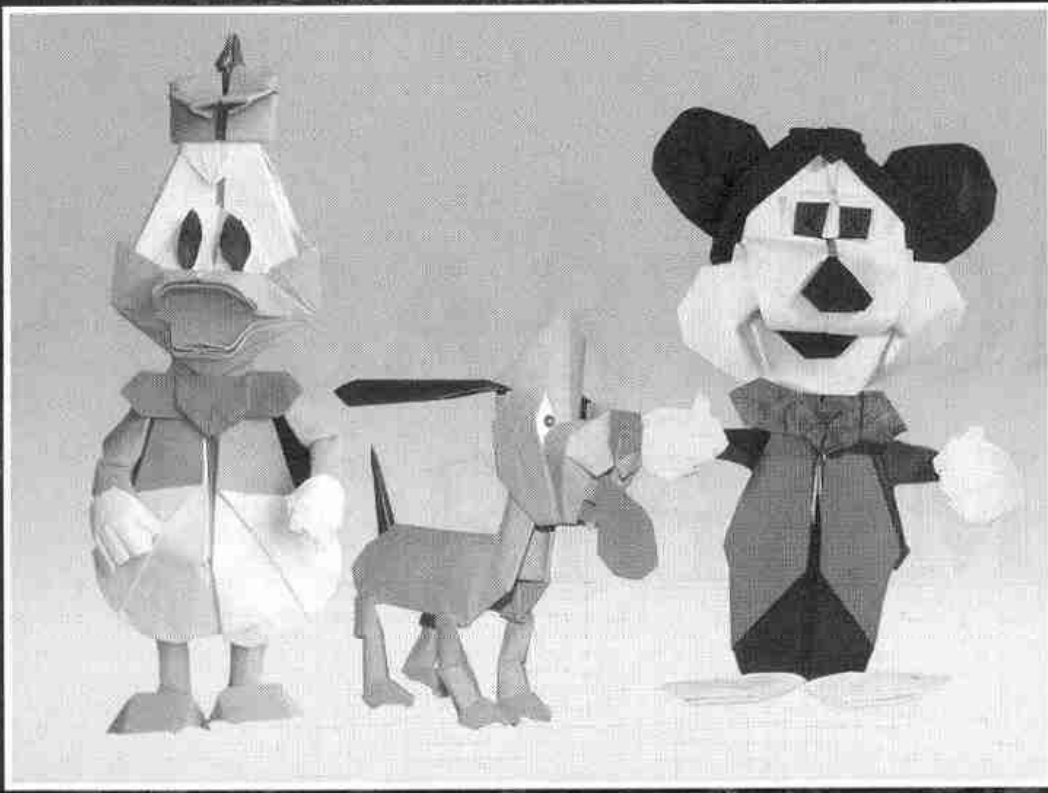

Autor
Fecha de edición
Edición
Modelos diagramados por
Recortados de fotografías

Halle
Noviembre 2002
700 ejemplares
J.A.V.I.
Alfredo Pérez

Tablas realizadas por **Alfredo Pérez Jiménez**

COLABORADORES NACIONALES

J.A.V.I. (Madrid)
Alfredo Pérez Jiménez (Madrid)
José R. Quintana Delgado (Las Palmas)
Manuel Sirgo Alvarez (León)

COLABORADORES INTERNACIONALES

Nicolas Terry (Francia)
Shai Aharon (Nueva Zelanda)
Thiago Alexandre Dos Santos (Brasil)
Penny Groom (Reino Unido)
Dario Motterle (Italia)

CARTOON ORIGAMI 2

*By
Halle*

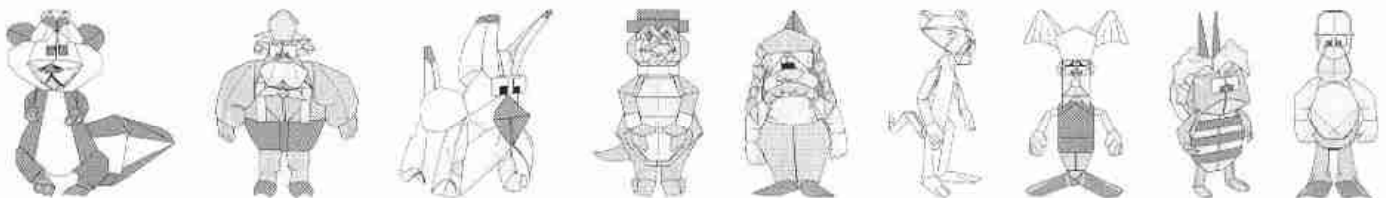
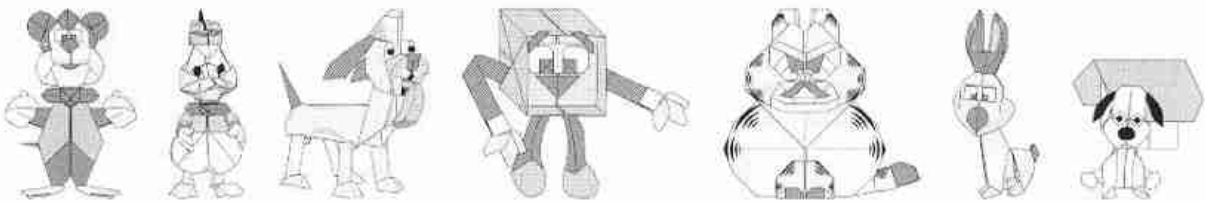

ÍNDICE



PÁGINA 12

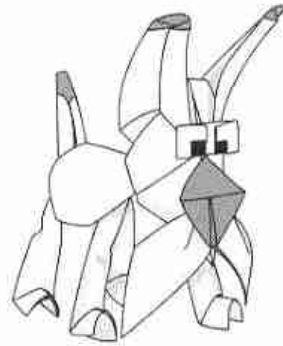

PÁGINA 23

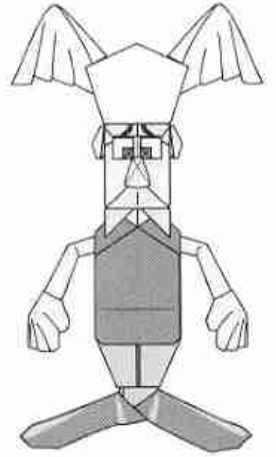

PÁGINA 31

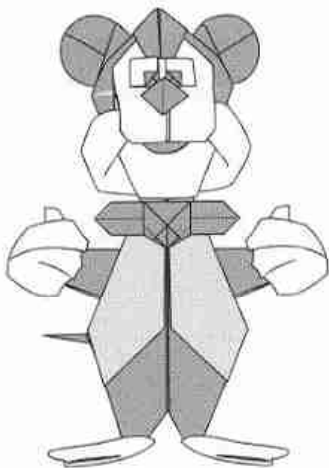

PÁGINA 39

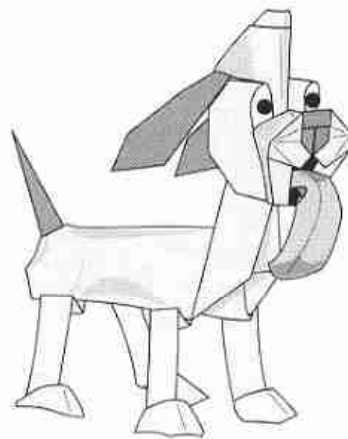

PÁGINA 50



PÁGINA 57

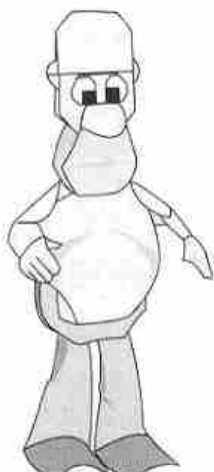

PÁGINA 68

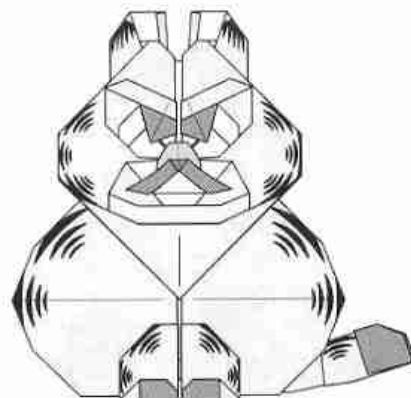

PÁGINA 75

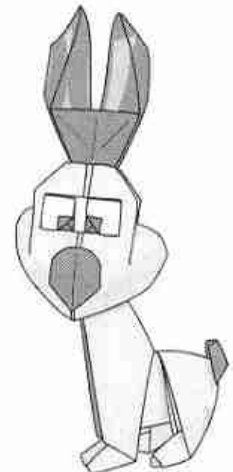

PÁGINA 82

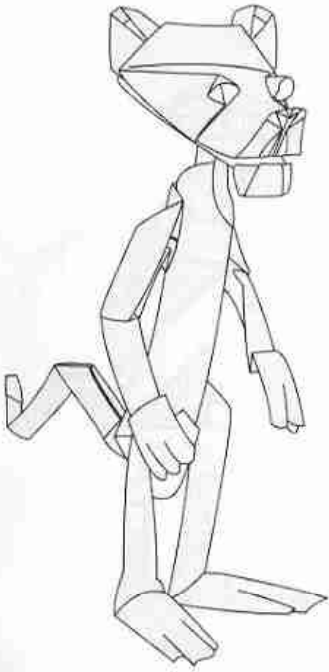

PÁGINA 90

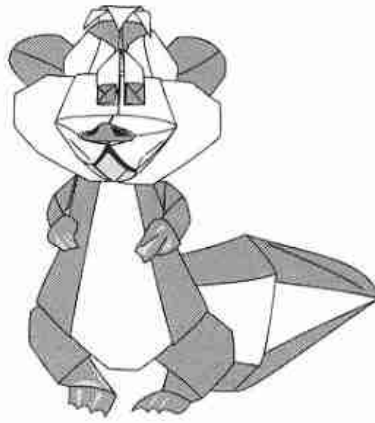

PÁGINA 100



PÁGINA 108

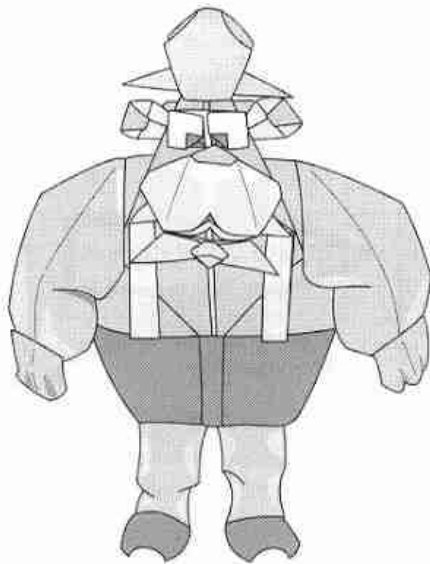

PÁGINA 117

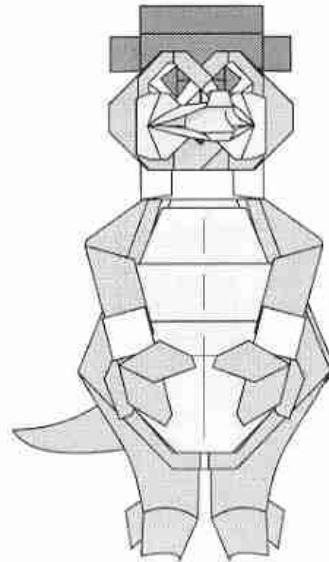

PÁGINA 126



PÁGINA 134

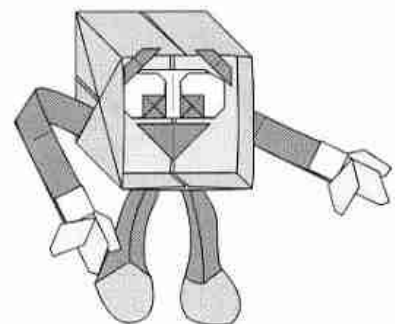

PÁGINA 142

10/10/10

10/10/10

10/10/10

10/10/10

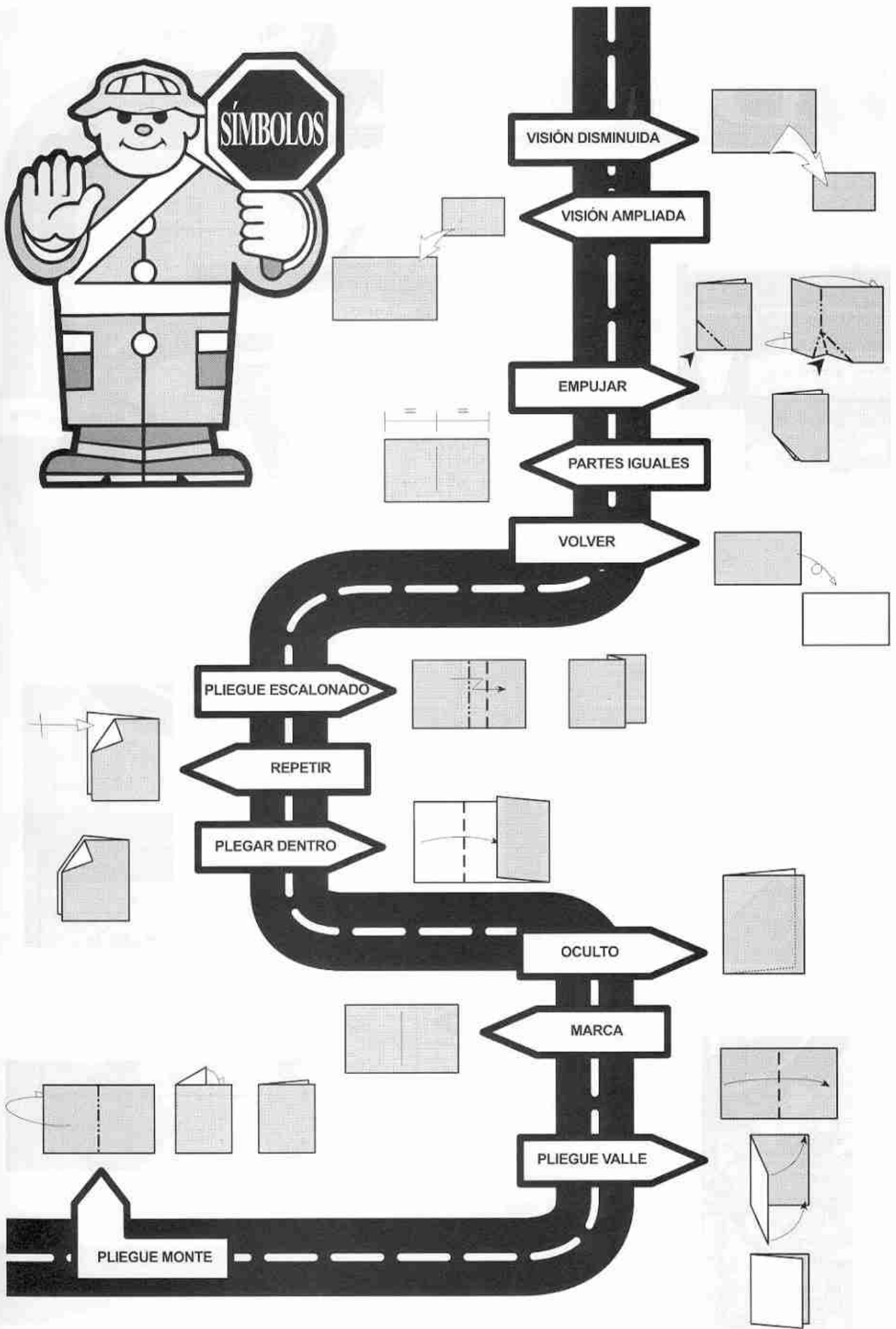

BASES

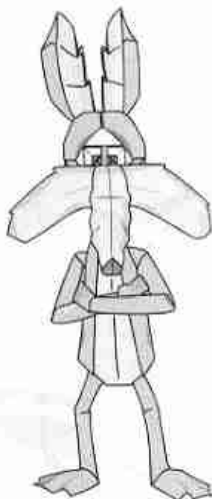
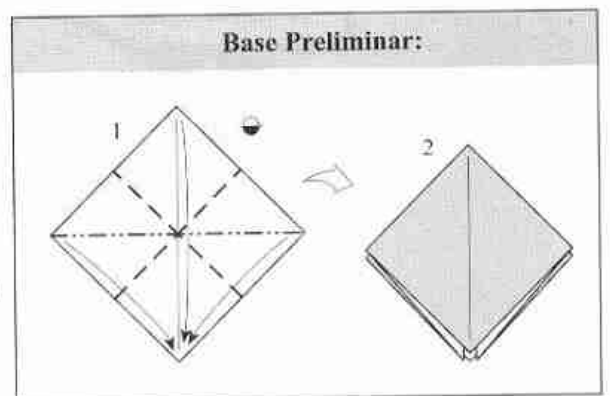
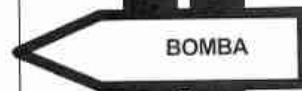
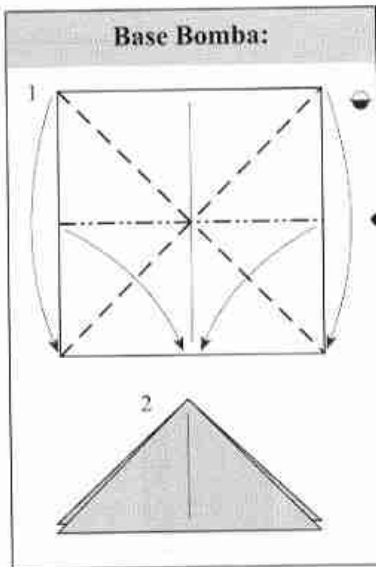
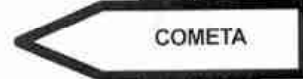
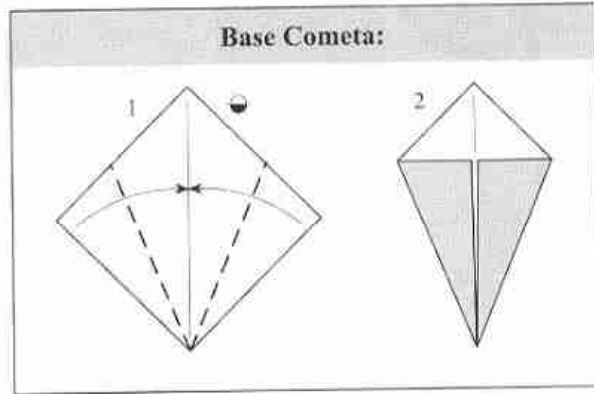

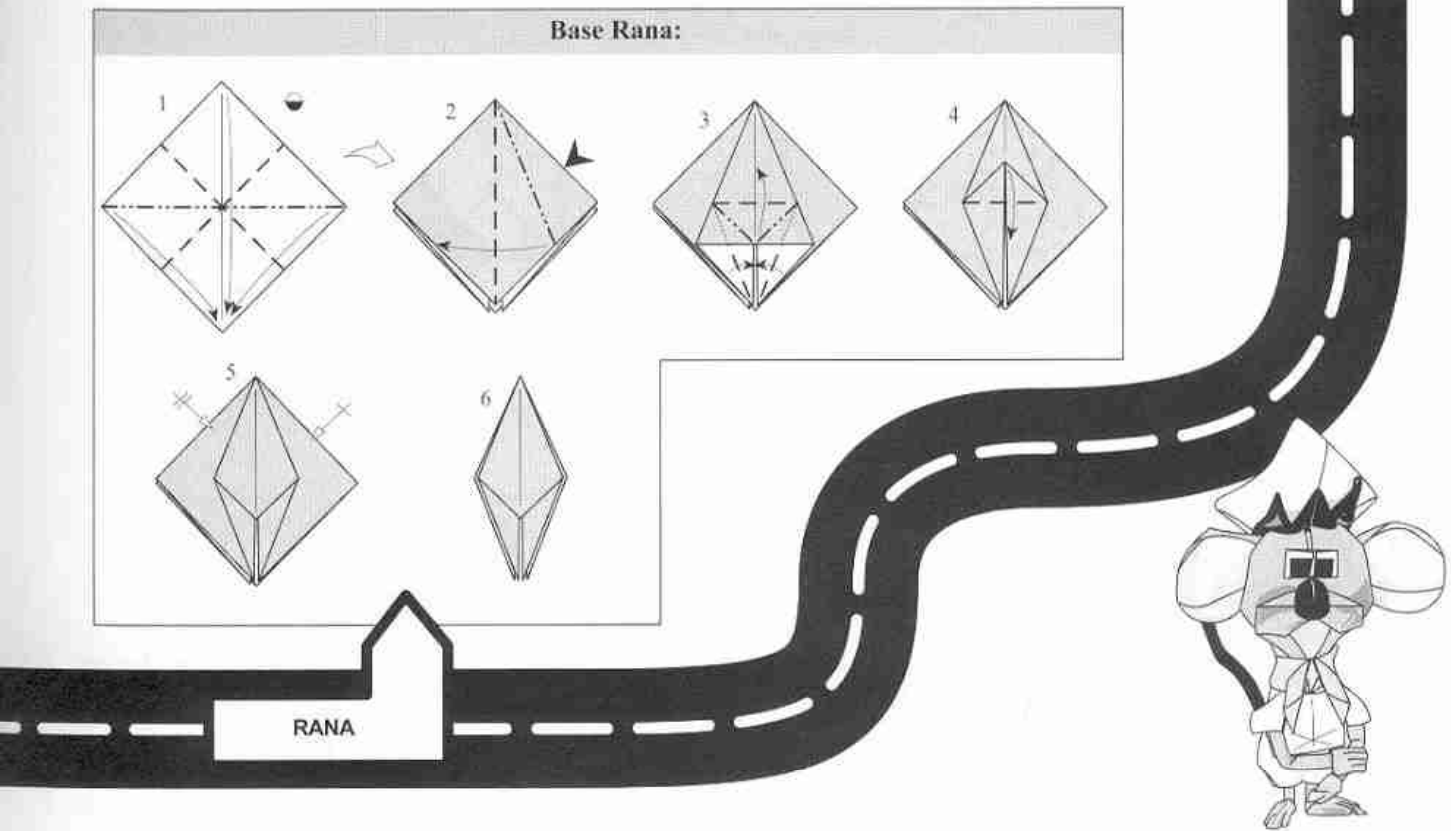
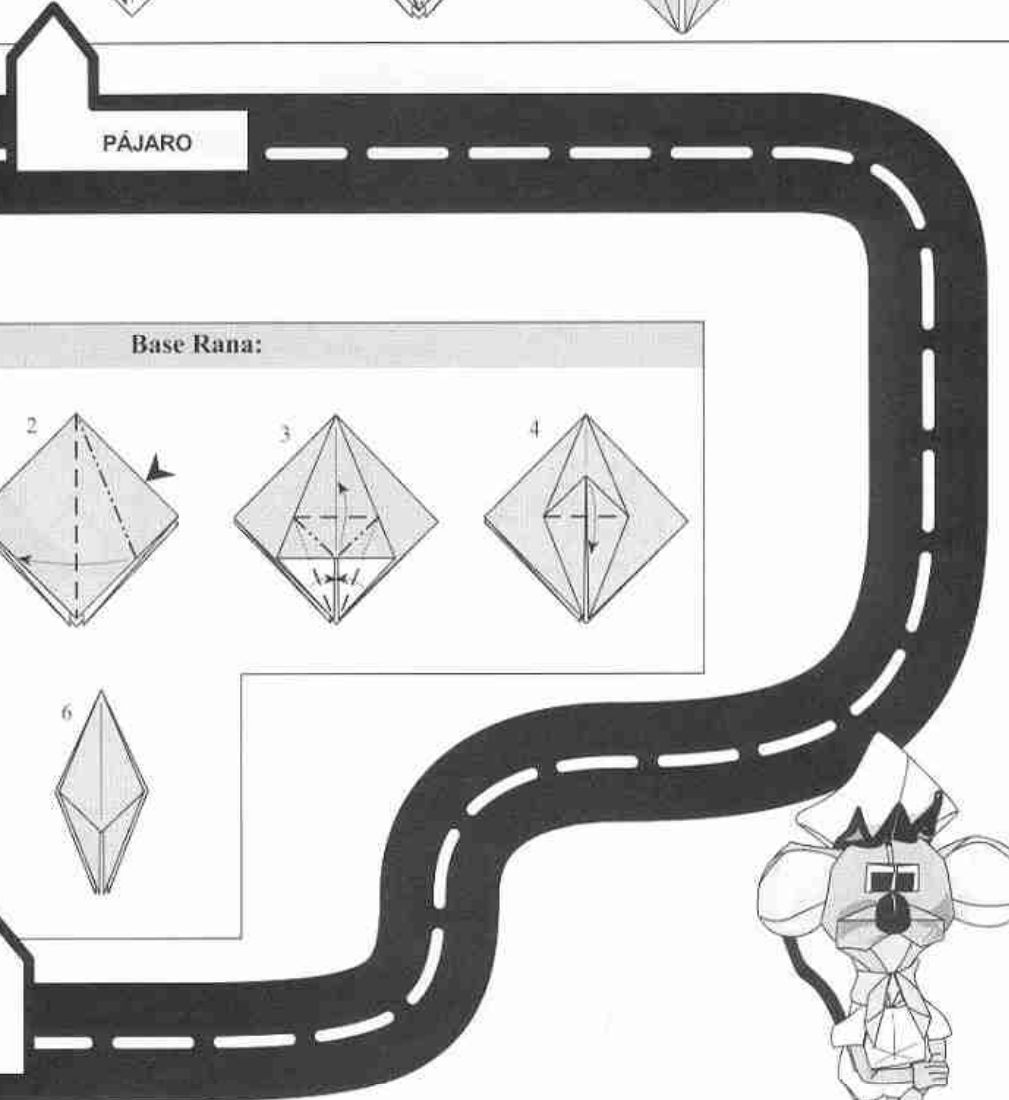
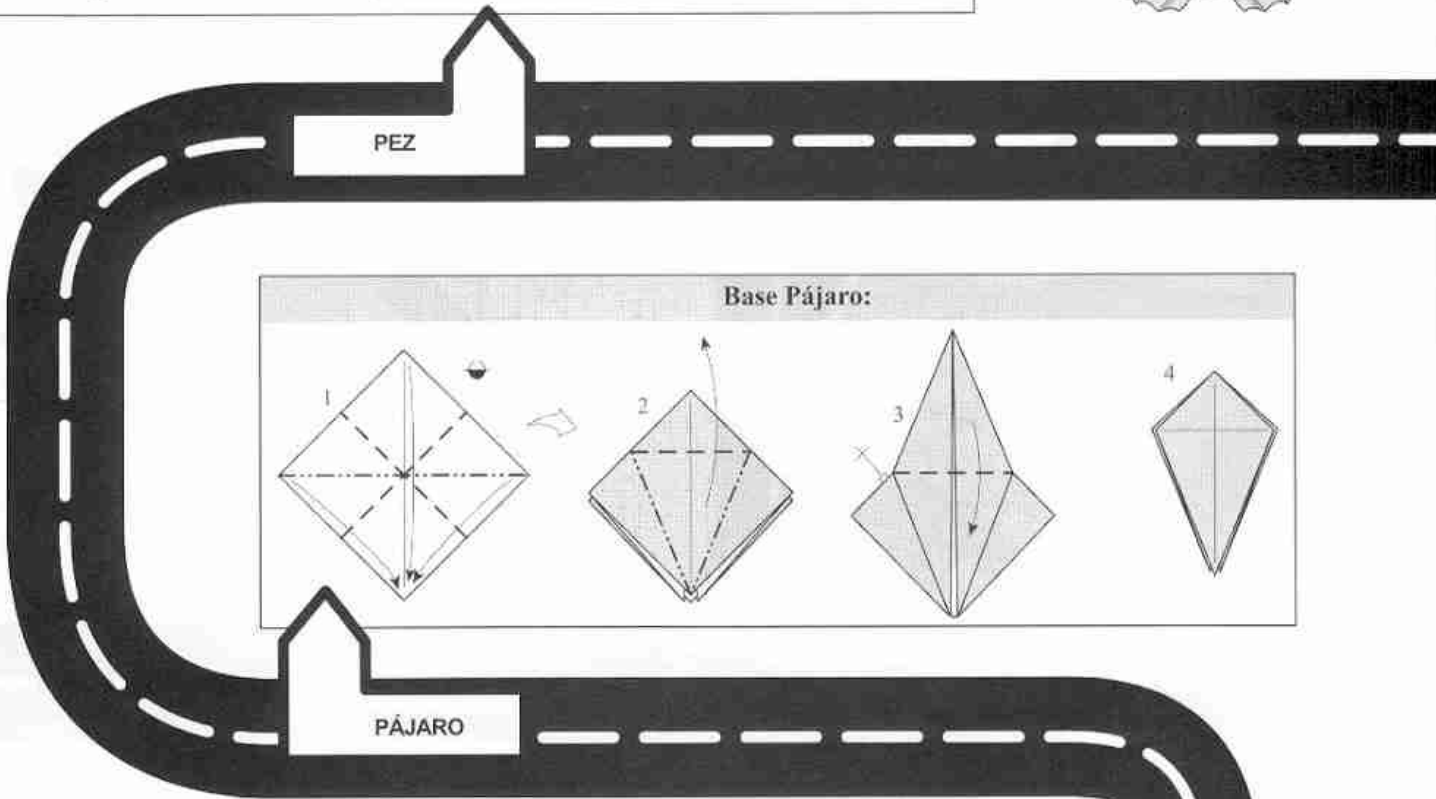
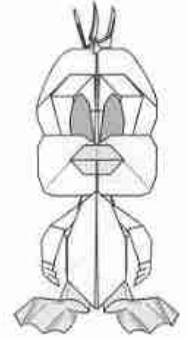
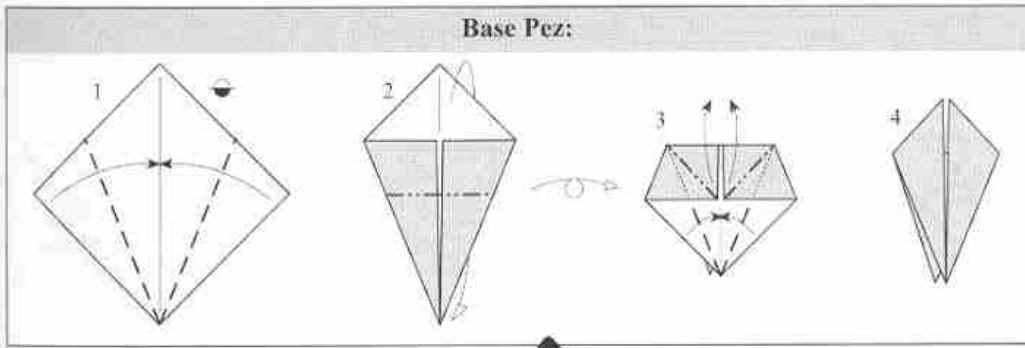

Base Pájaro estirada:

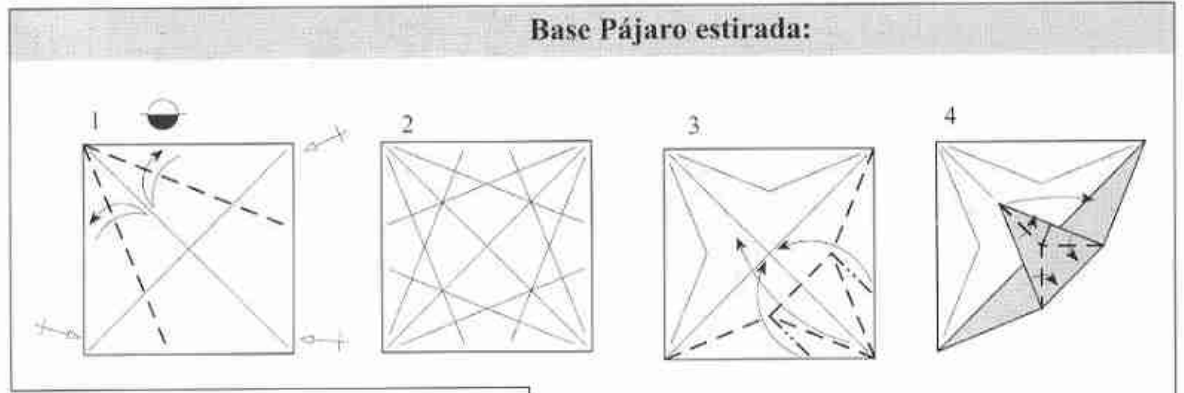

PÁJARO ESTIRADA



5 Repetir 3 y 4.

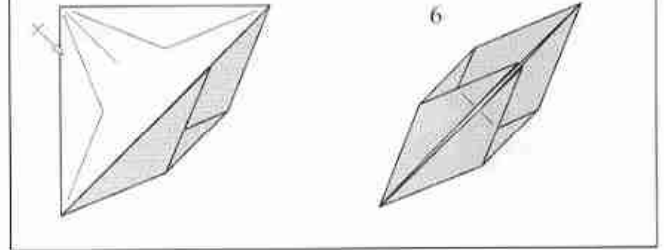

BLINTZ PEZ

Base Blintz Pez:

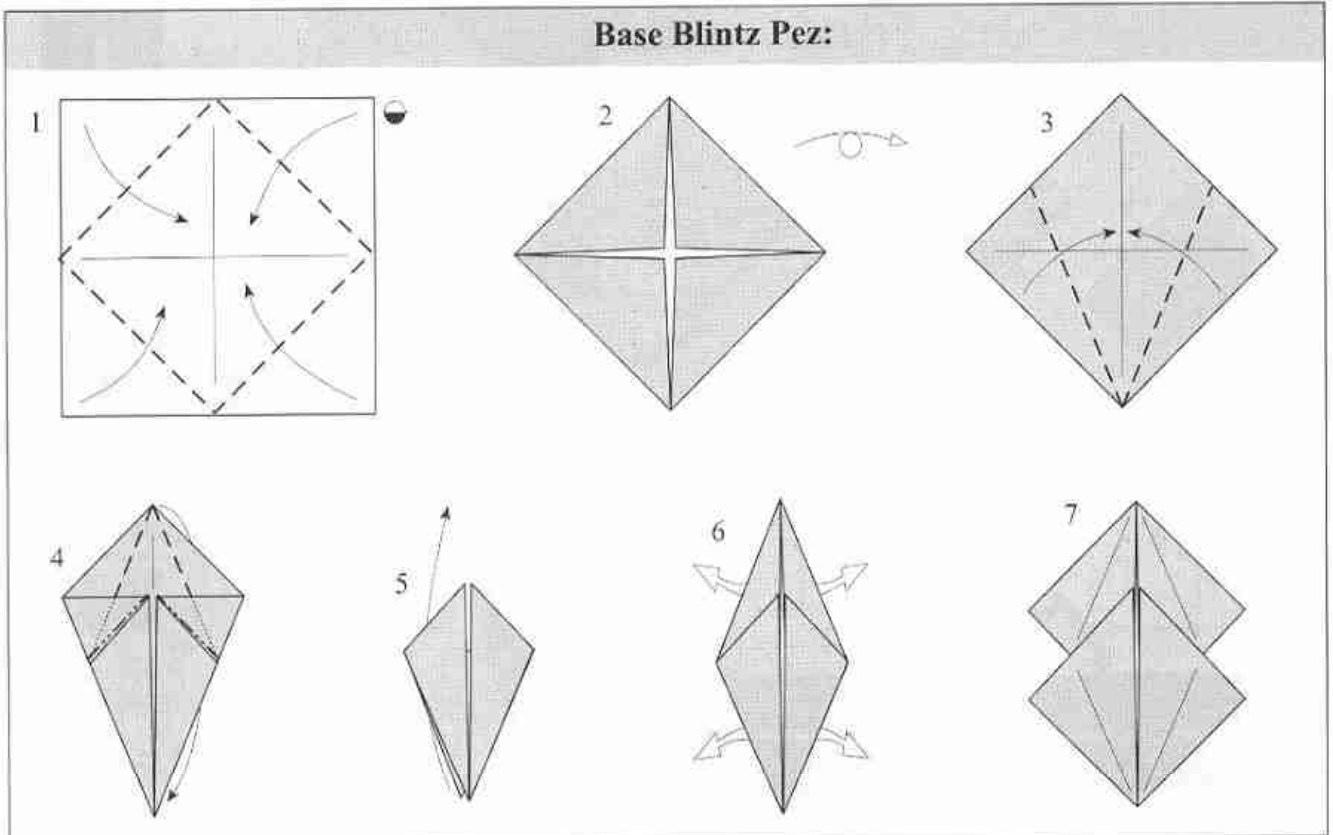

Base Blintz Pájaro:

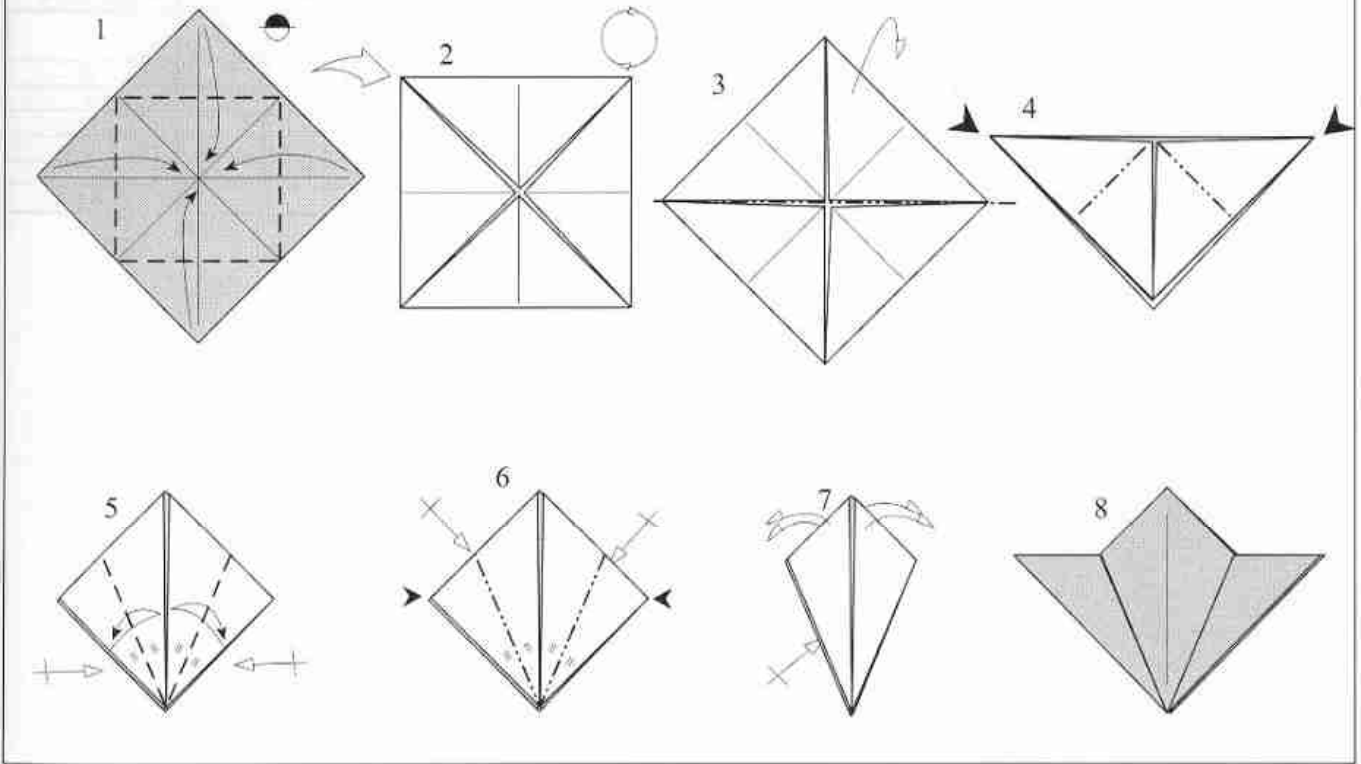

BLINTZ PÁJARO

BLINTZ RANA

Base Blintz Rana:

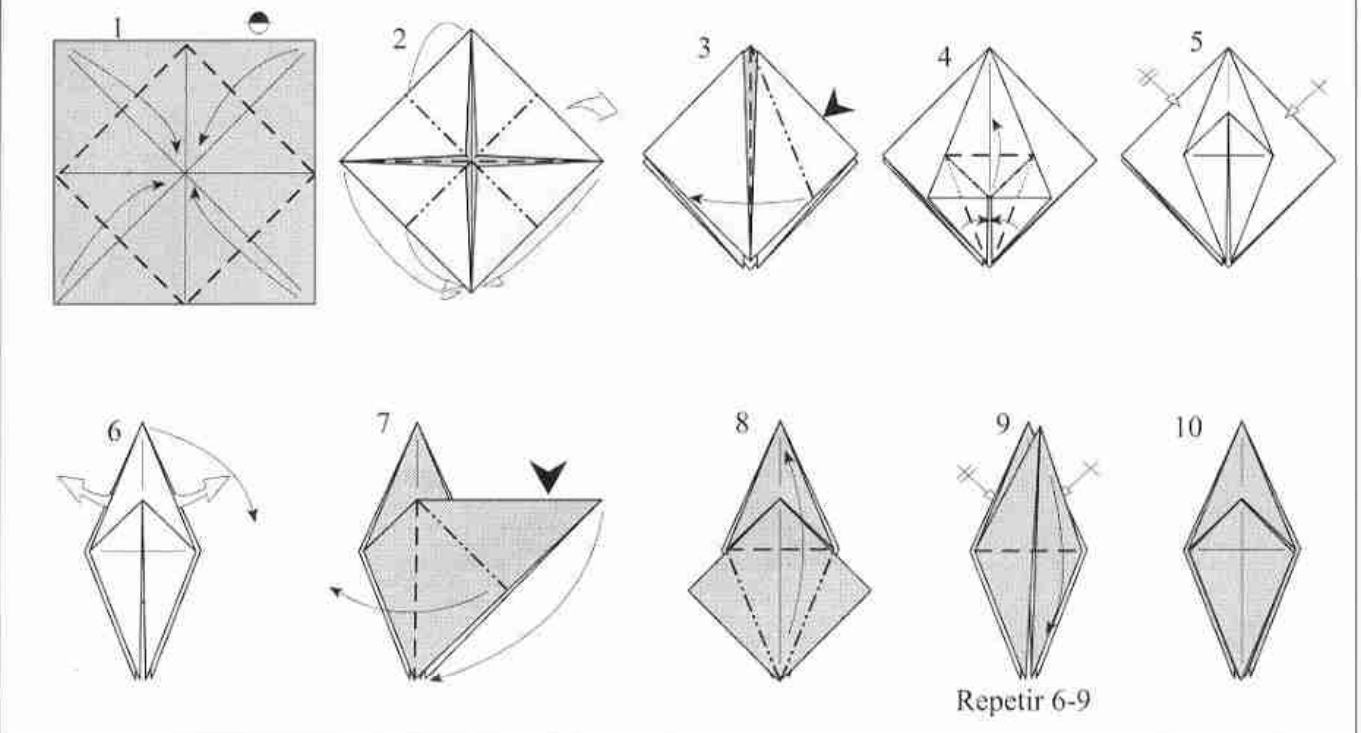

Página (Desarr.)	Pieza nº	Cantidad	Porción	COLORES		Tamaño original	Tamaño 3/10	Tamaño 2/5	Tamaño 3/5
				Anverso	Reverso	16 cm alto	4,8 cm alto	6,4 cm alto	9,6 cm alto
						Lado (cm) =	Lado (cm) =	Lado (cm) =	Lado (cm) =
13	1	1	Menir	Gris	Azul	20	6	8	12
13	2	1	Cuerpo	Rosa	Azul	20	6	8	12
14	3	2	Brazos	Neutro	Rosa	10	3	4	6
15	4	1	Cara+Pelo	Rosa	Rojo	20	6	8	12
19	5	2	Pies	Marrón	Azul	10	3	4	6
20	6	1	Ojos	Negro	Blanco	5	1,5	2	3
21	7	1	Bigotes	Neutro	Rojo	7,5	2,25	3	4,5



Plegado por: J.A.V.I.

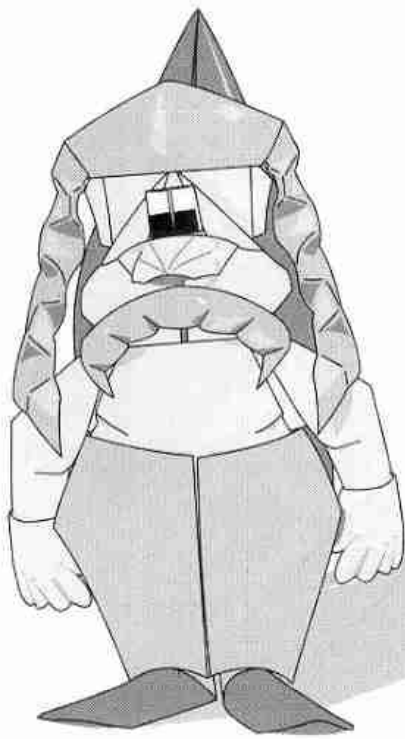

Utilizando las medidas recomendadas, se obtiene un modelo final de 16 cms.

Autor:	Halle
Nivel de dificultad:	Alto
Número de piezas:	9
Forma de las piezas:	Cuadrados

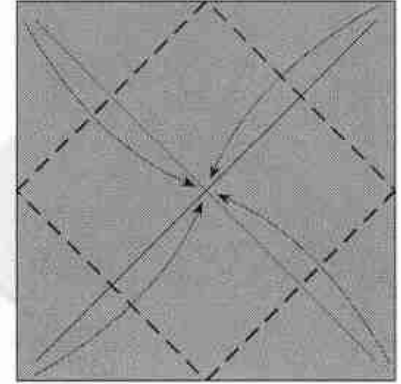

● Gris
● Azul

□ 20 cm
□ 20 cm

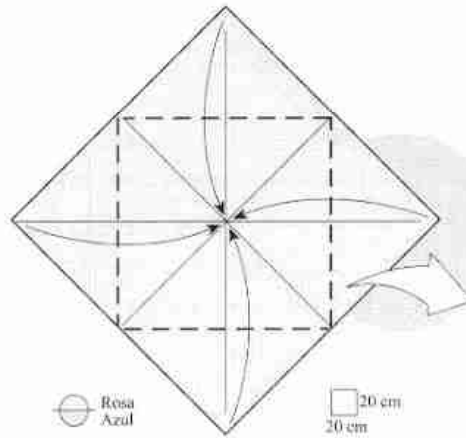
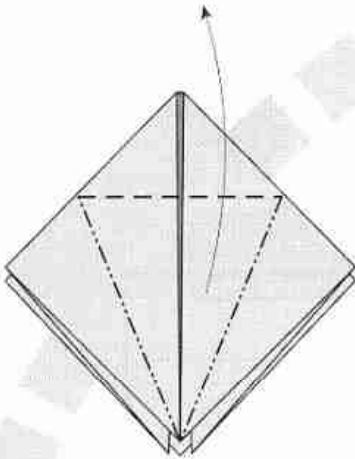
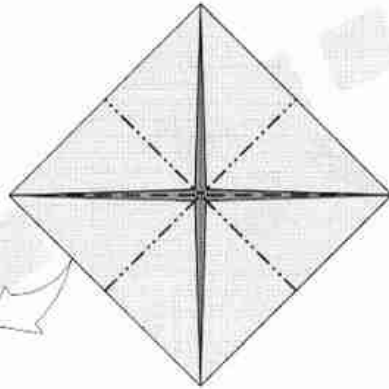

● Rosa
● Azul

□ 20 cm
□ 20 cm

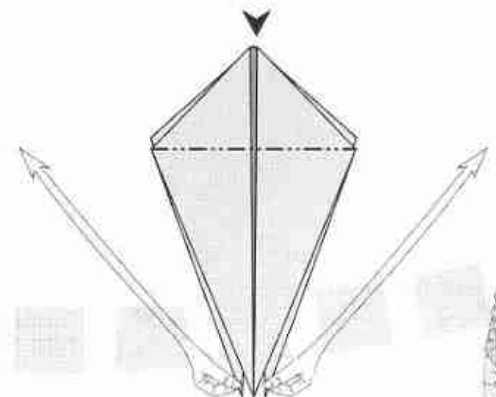
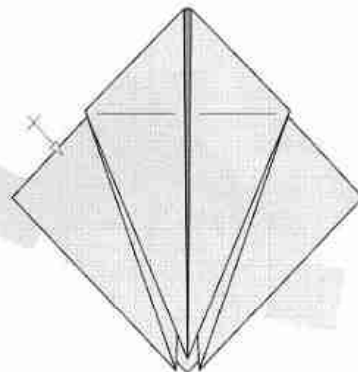
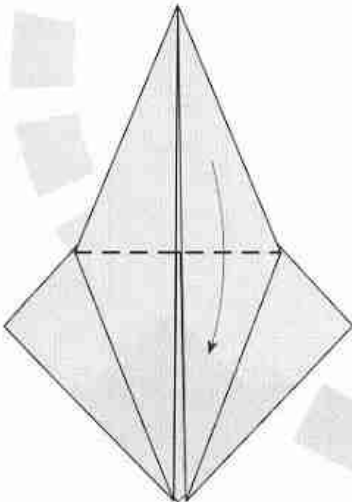
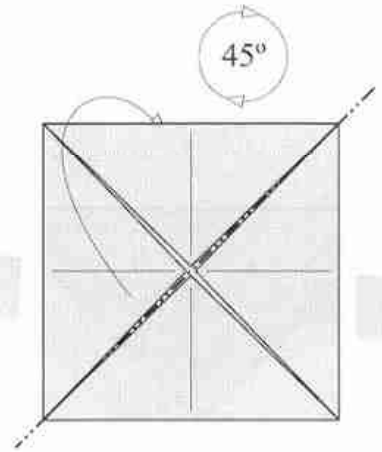

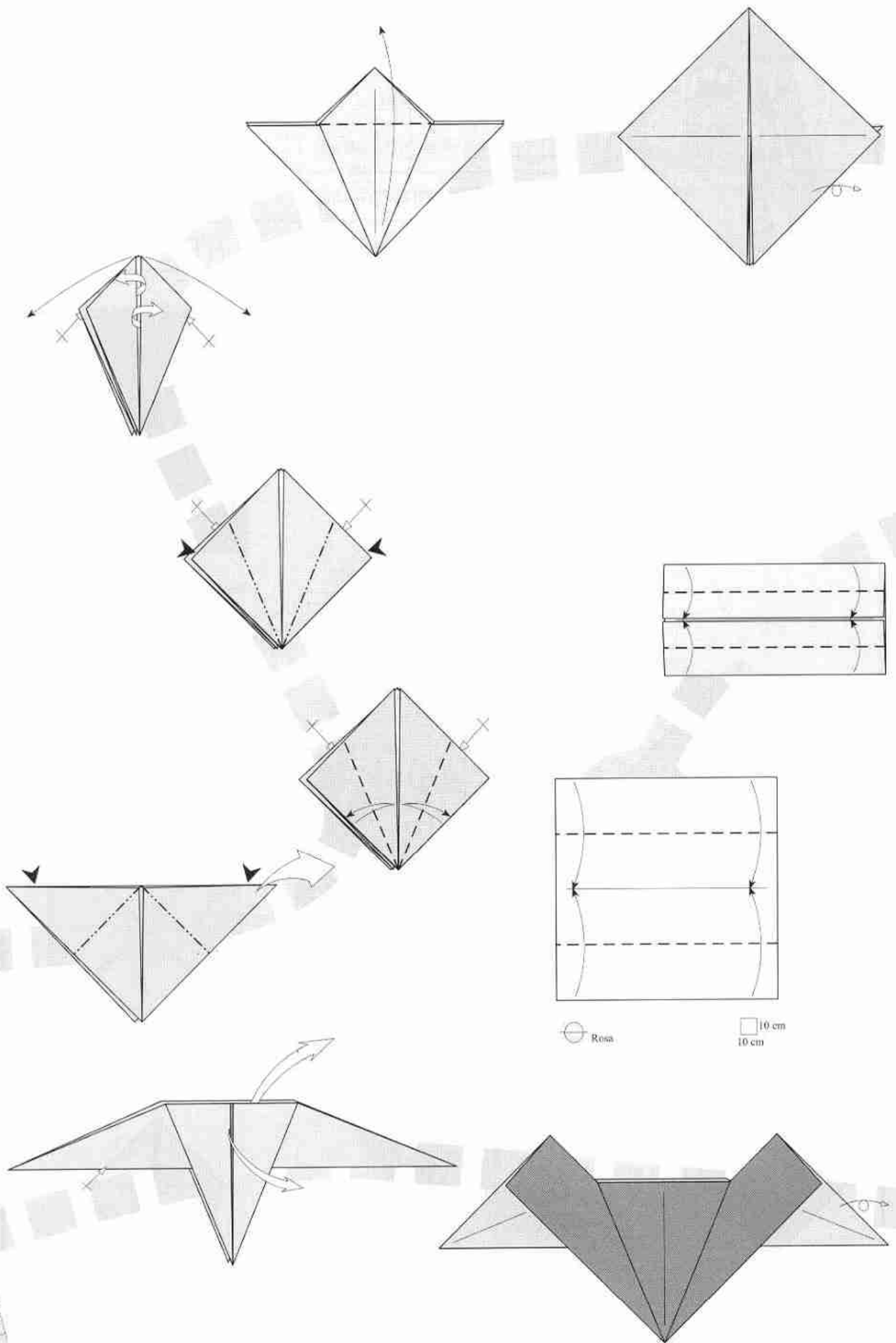

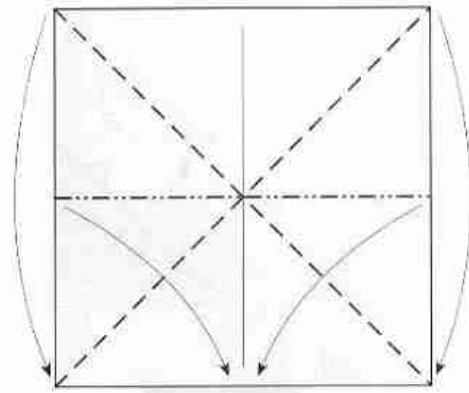
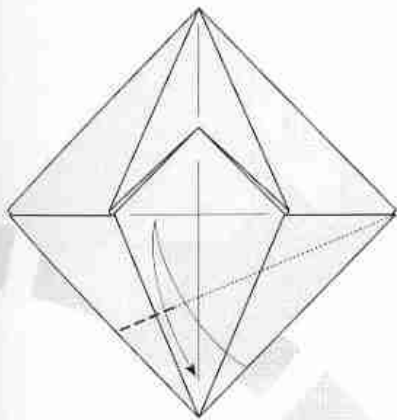

180°

Rosa Rojo

20 cm
20 cm

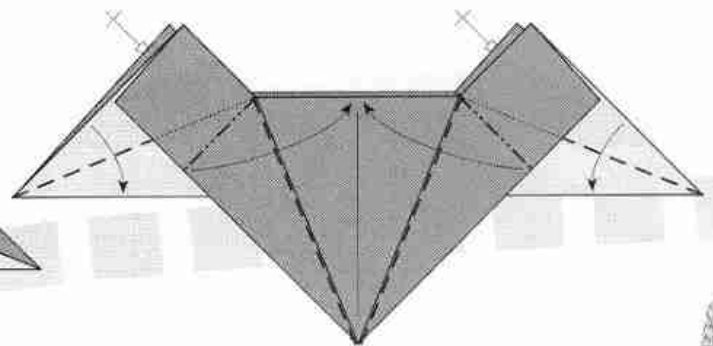
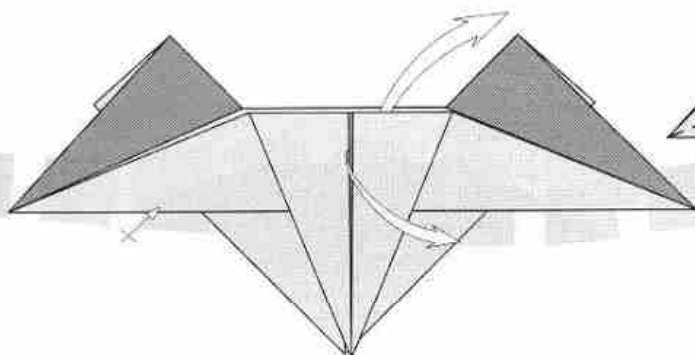
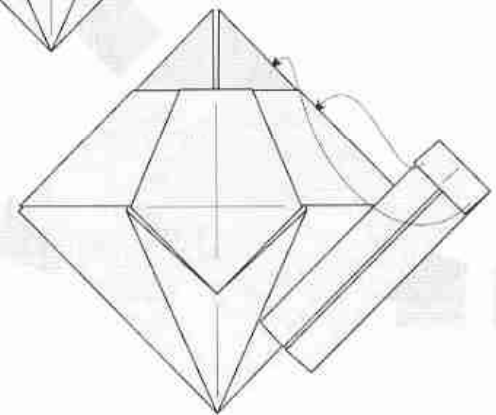
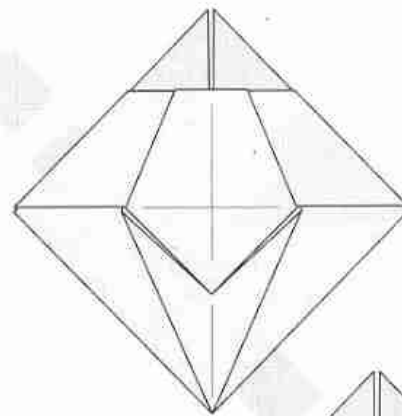
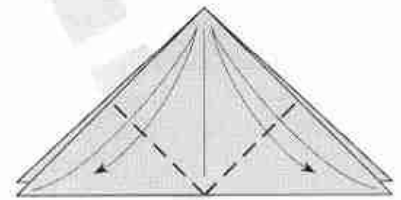
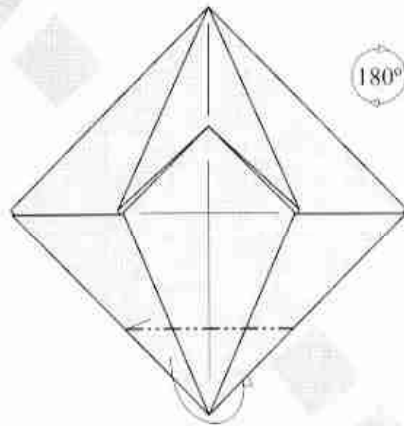

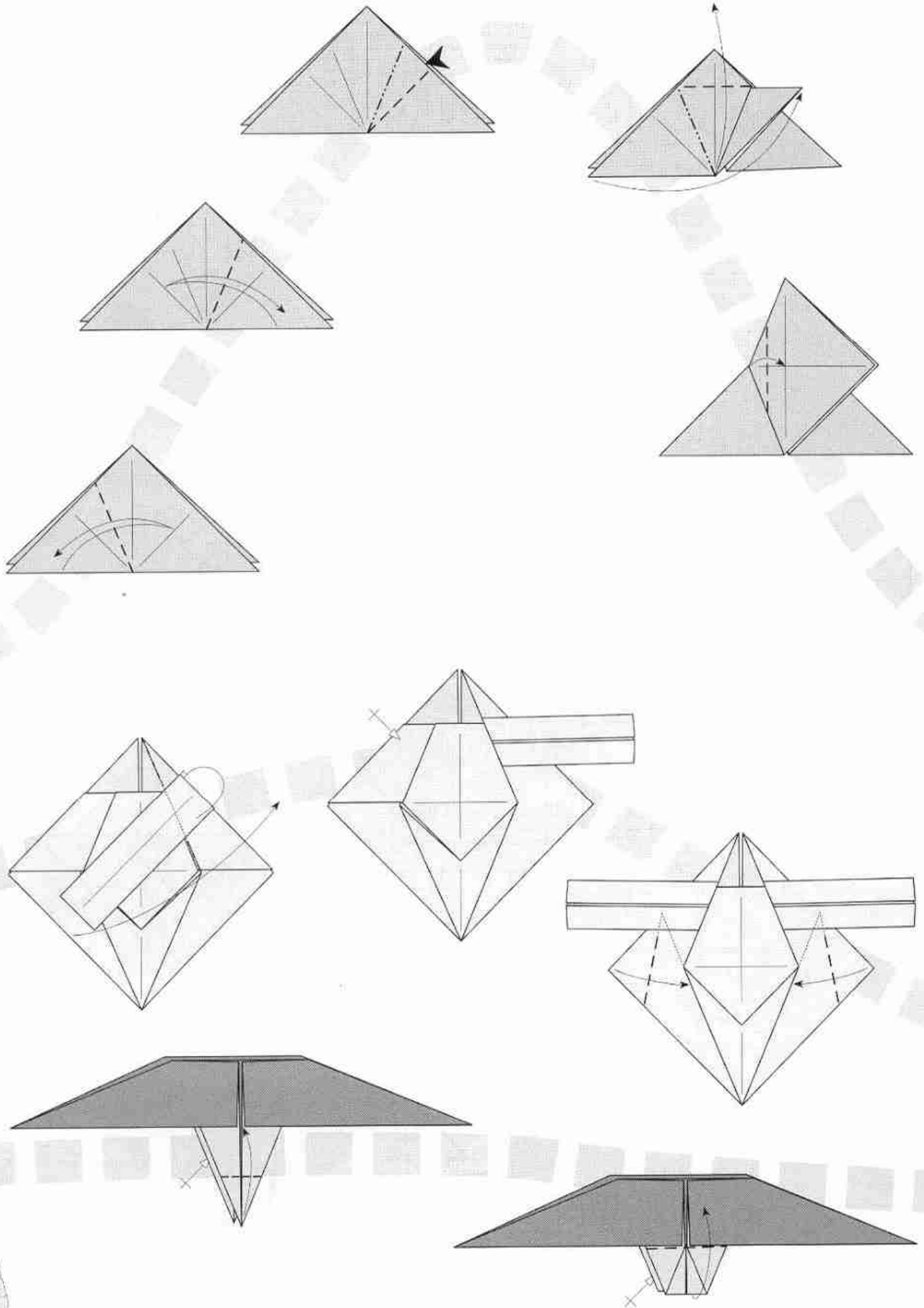

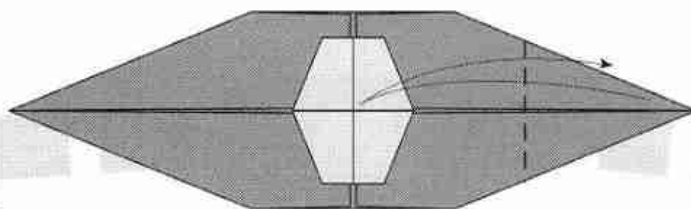
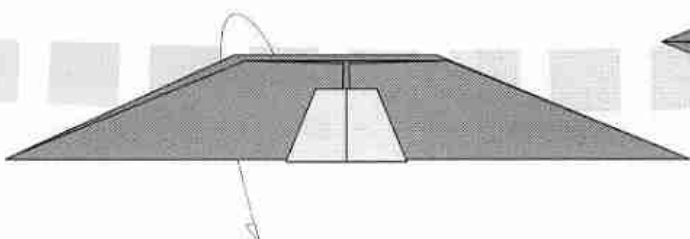
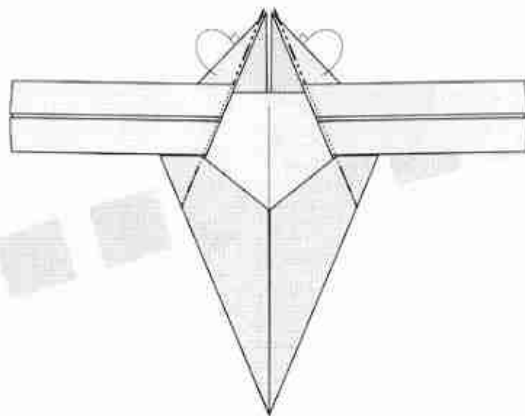
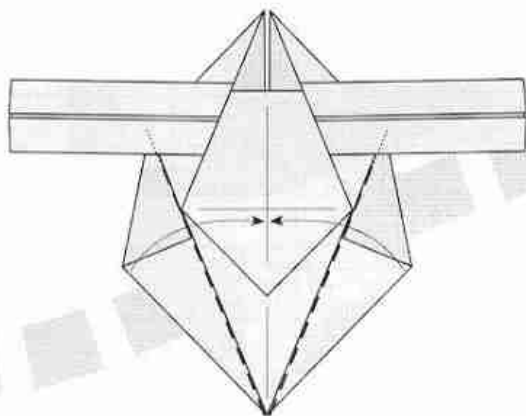
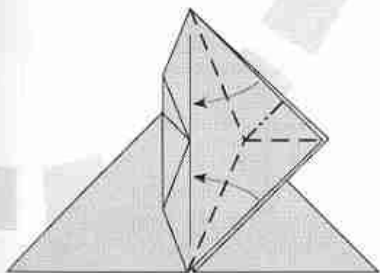
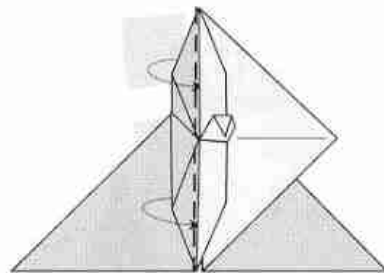
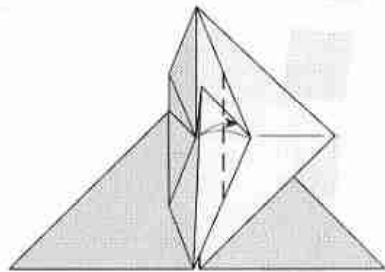
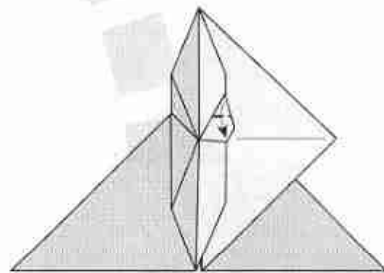
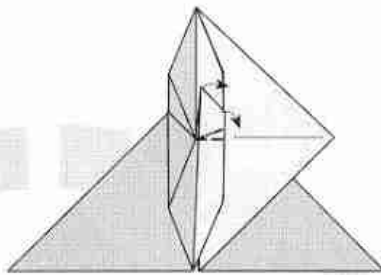
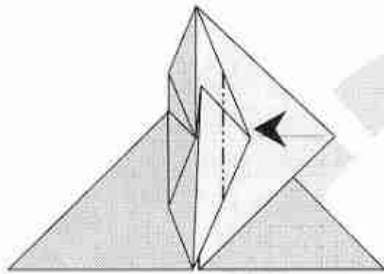

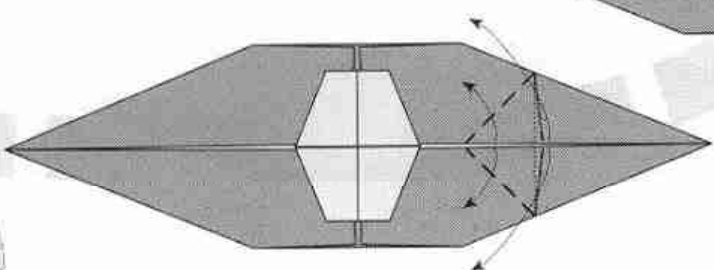
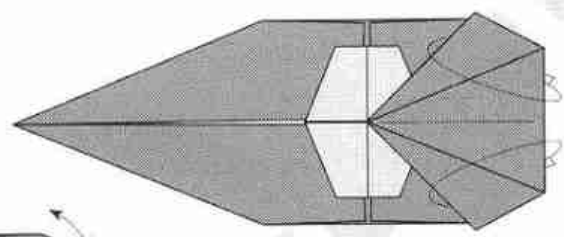
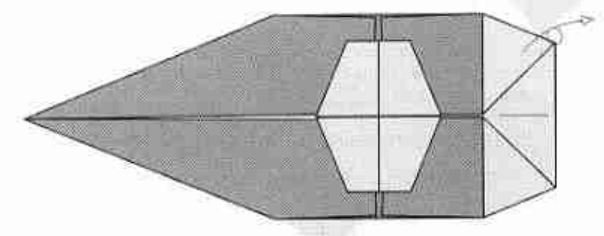
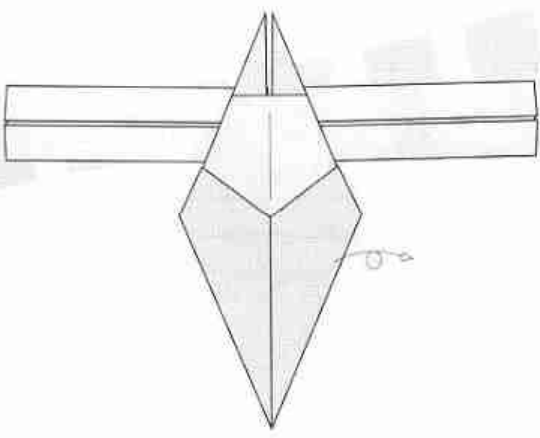
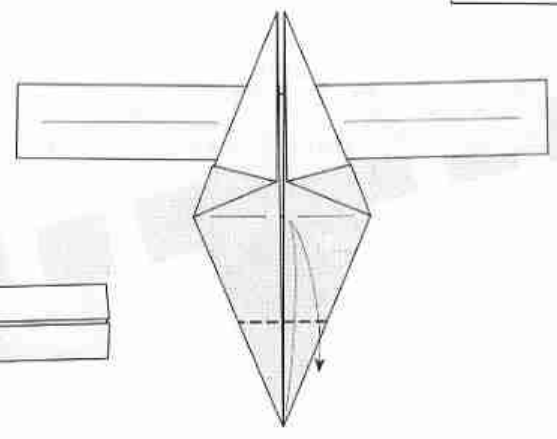
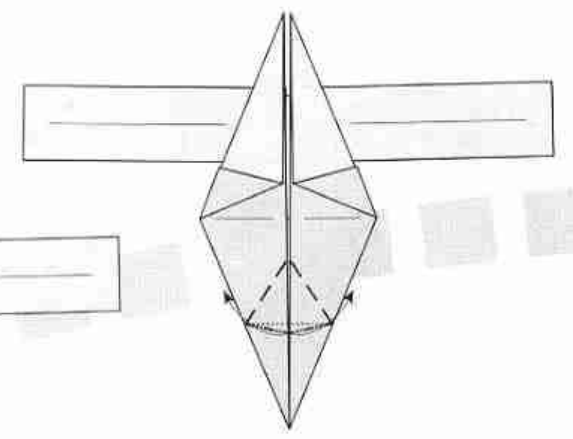
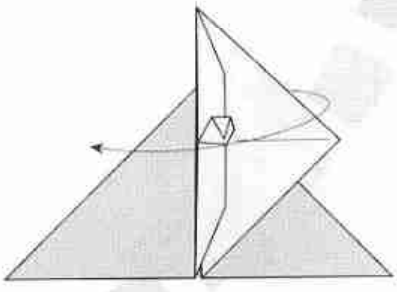
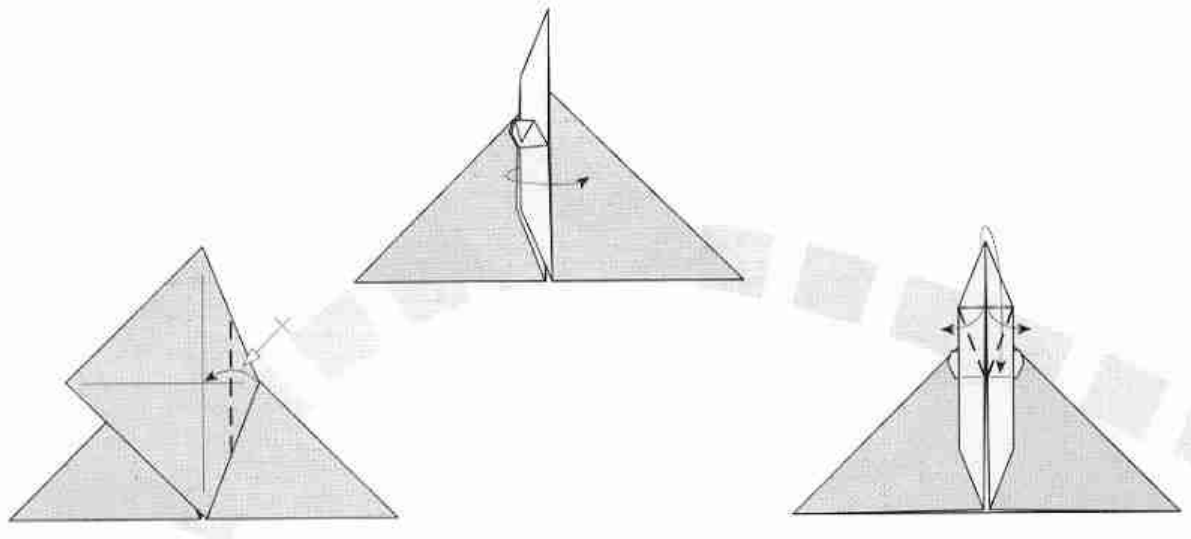

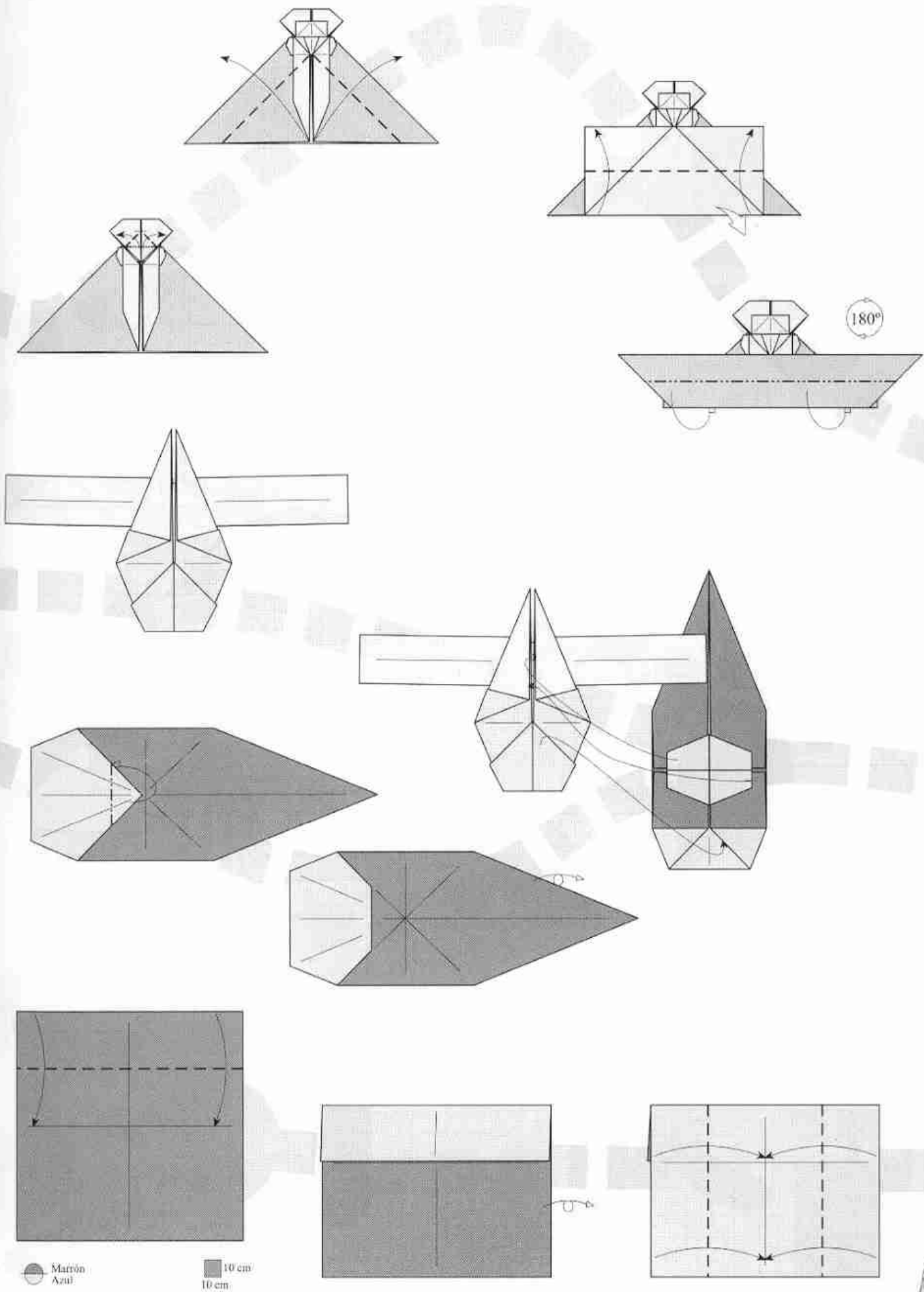

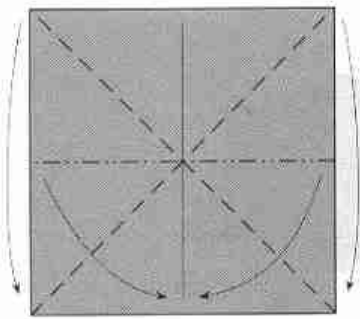

● Negro
○ Blanco

■ 5 cm
5 cm

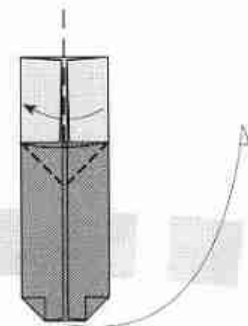
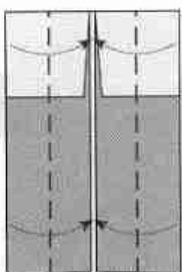
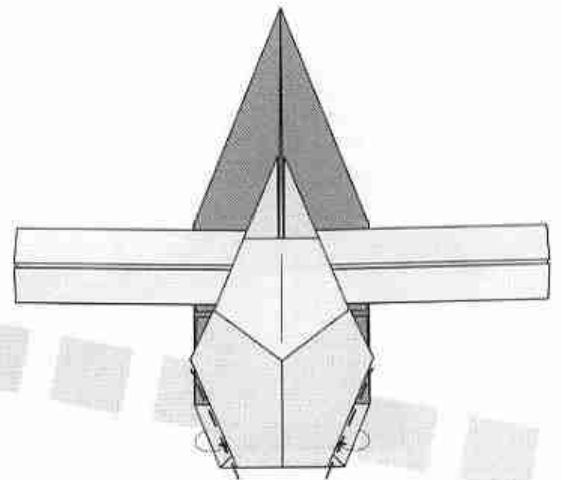
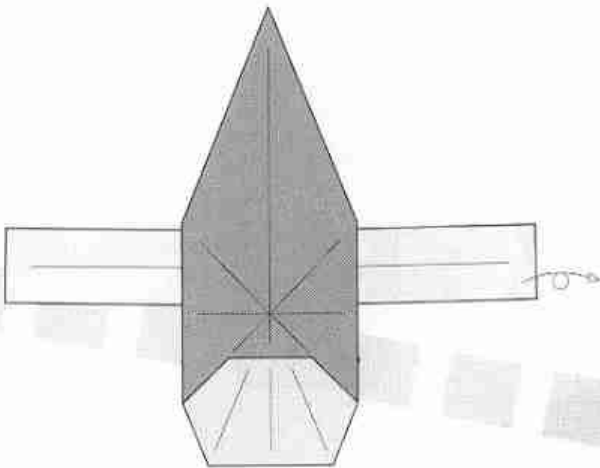
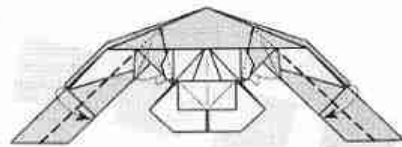
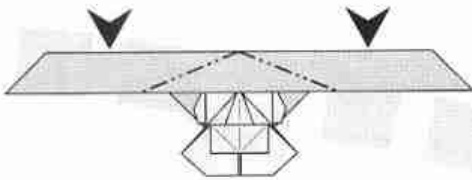
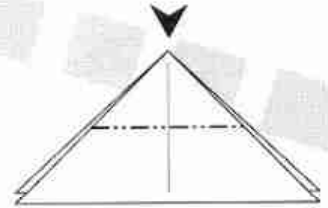
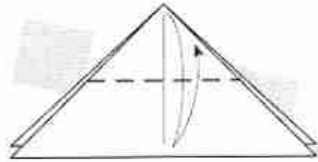

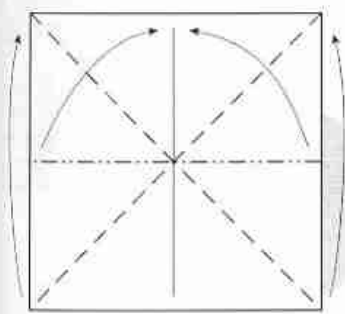

Bojo

7.5 cm
7.5 cm

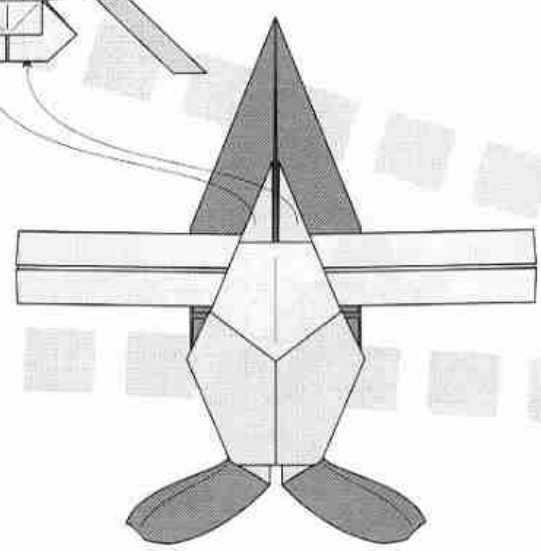
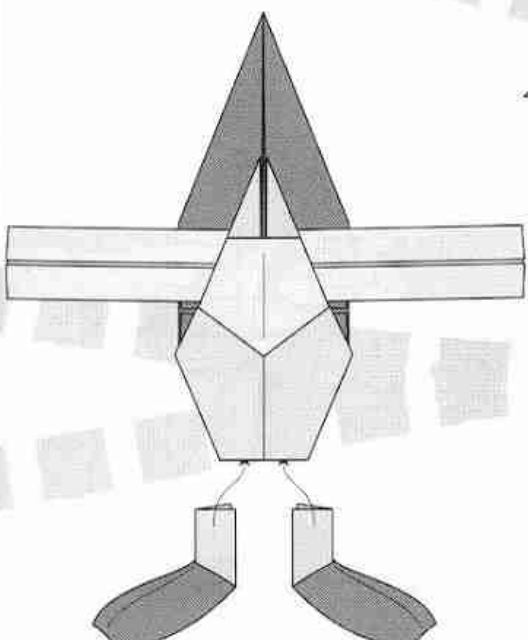
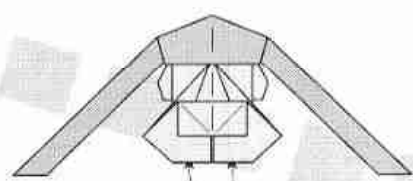
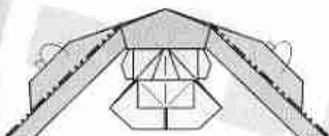
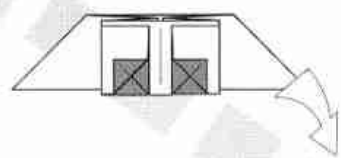
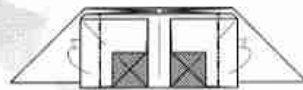
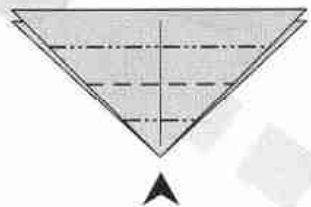
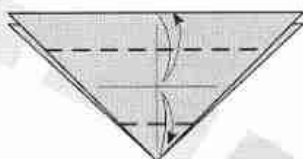
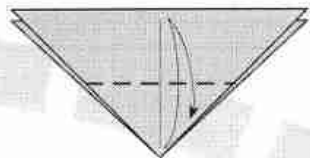

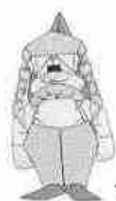
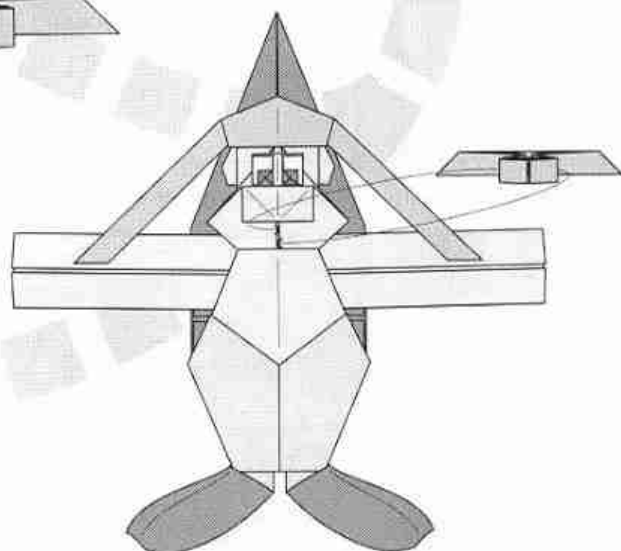
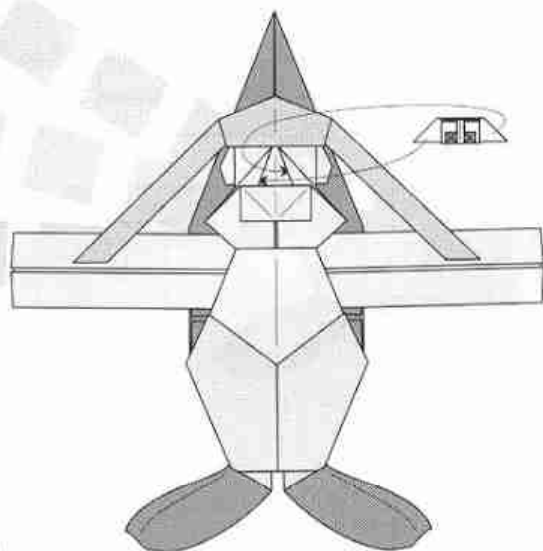
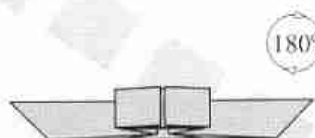
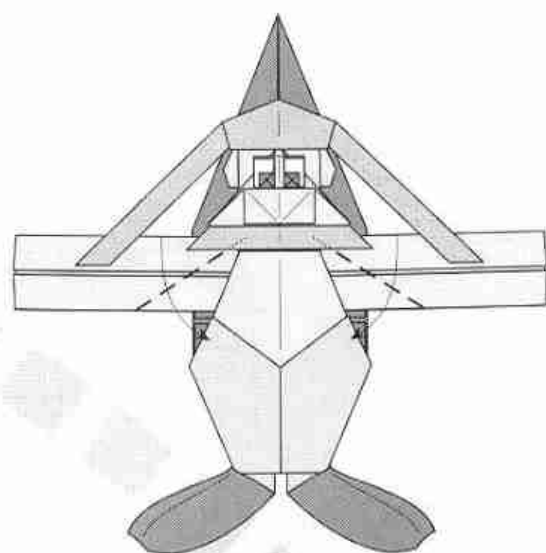
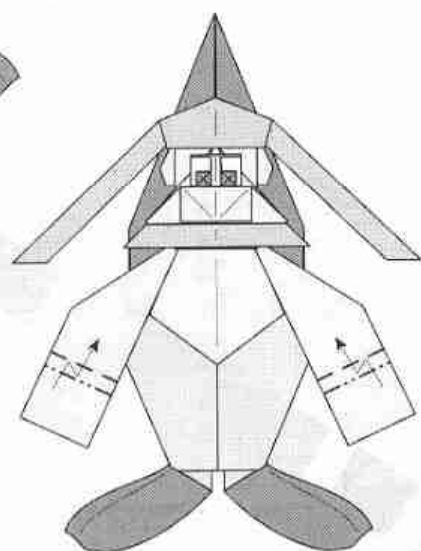
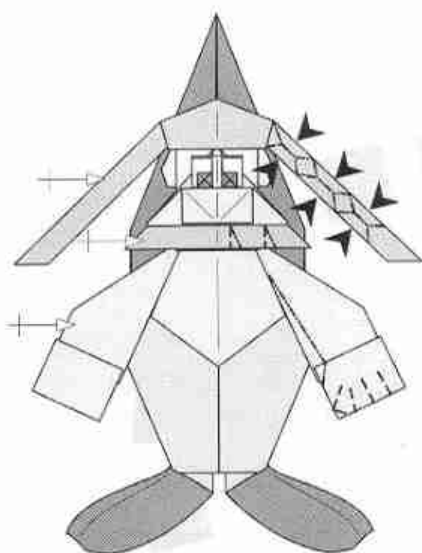

Página (Desarr.)	Pieza nº	Cantidad	Porción	COLORES		Tamaño original	Tamaño 3/10	Tamaño 2/5	Tamaño 3/5
				Anverso	Reverso	12 cm alto	3,6 cm alto	4,8 cm alto	7,2 cm alto
						Lado (cm) =	Lado (cm) =	Lado (cm) =	Lado (cm) =
24	1	1	Cara-orejas	Negro	Blanco	20	6	8	12
25	2	1	Cuerpo	Blanco	Negro	20	6	8	12
27	3	4	Patás	Neutro	Blanco	10	3	4	6
27	4	1	Ojos	Negro	Blanco	5	1,5	2	3
28	5	1	Boca-Barbas	Negro	Blanco	10	3	4	6

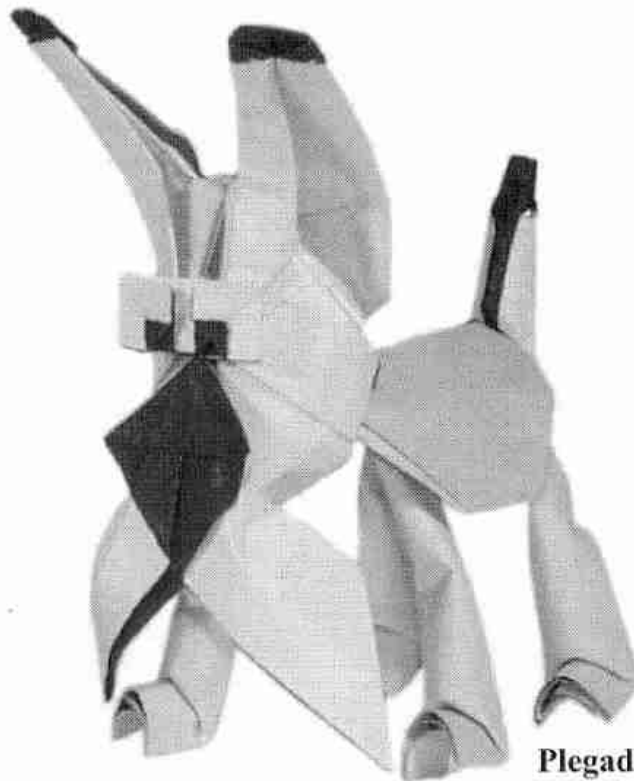

Plegado por: J.A.V.I.

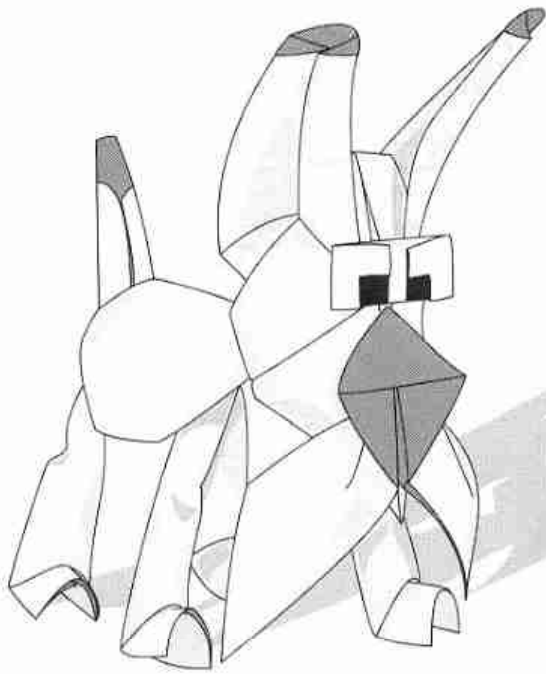

Utilizando las medidas recomendadas, se obtiene un modelo final de 12 cms.

Autor:	Halle
Nivel de dificultad:	Medio
Número de piezas:	8
Forma de las piezas:	Cuadrados

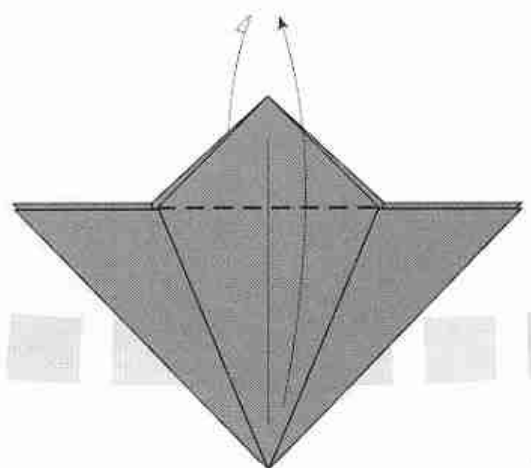
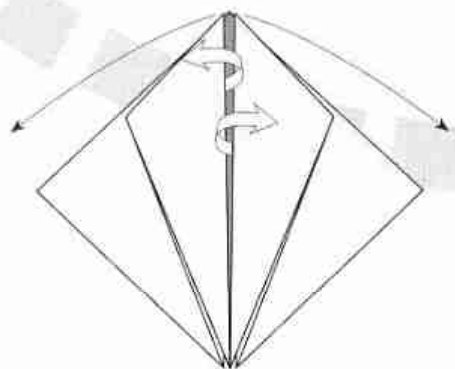
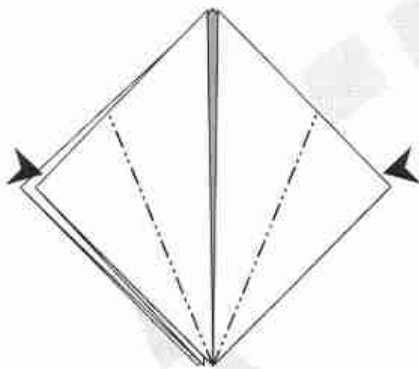
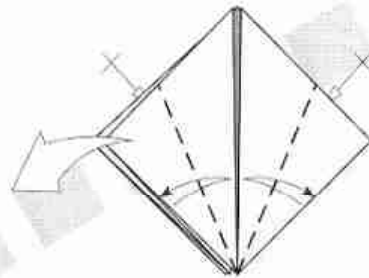
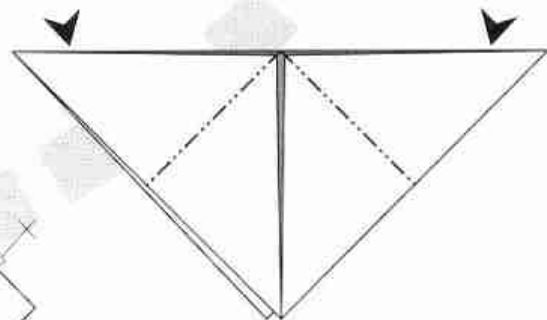
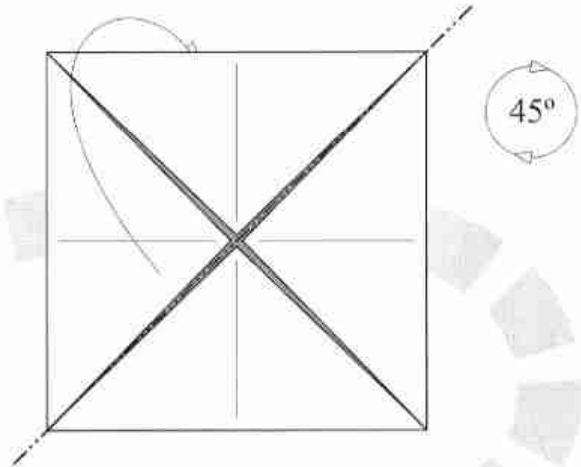
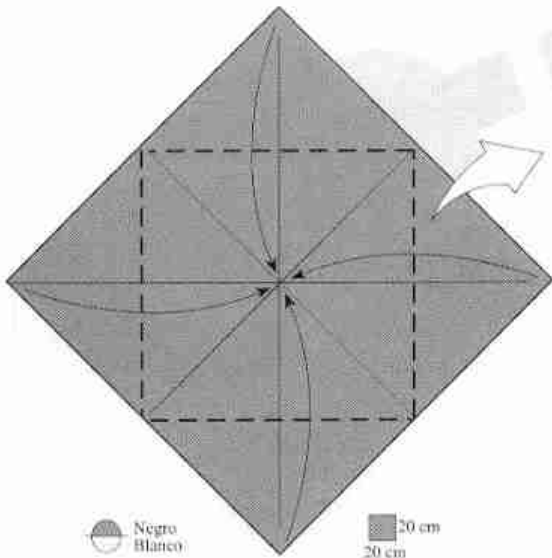

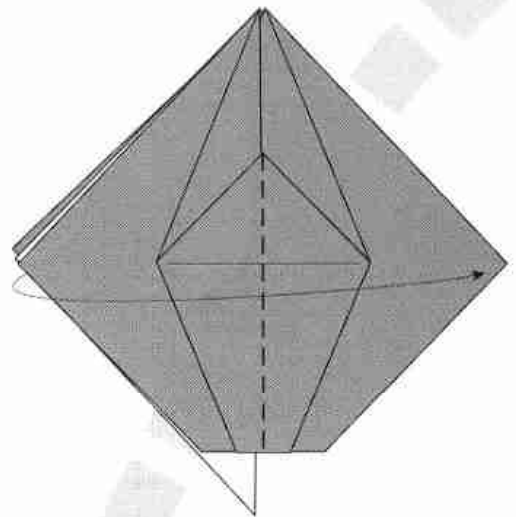
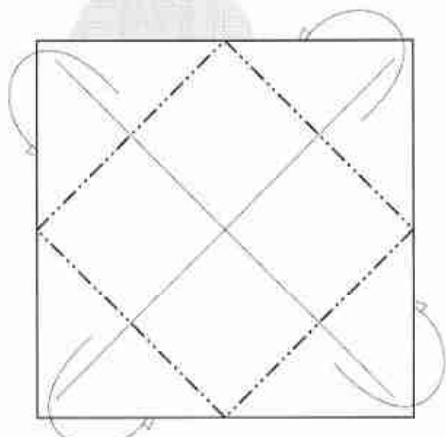
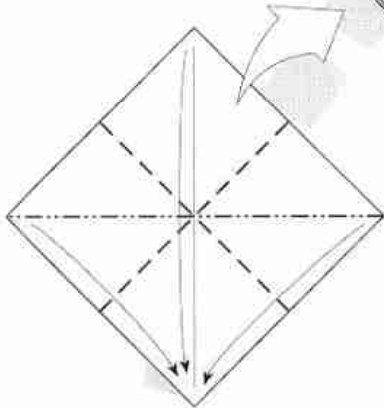
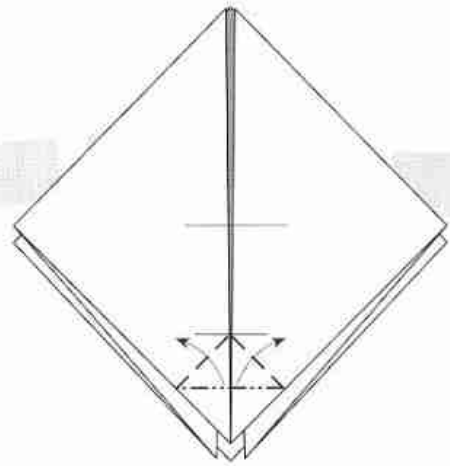
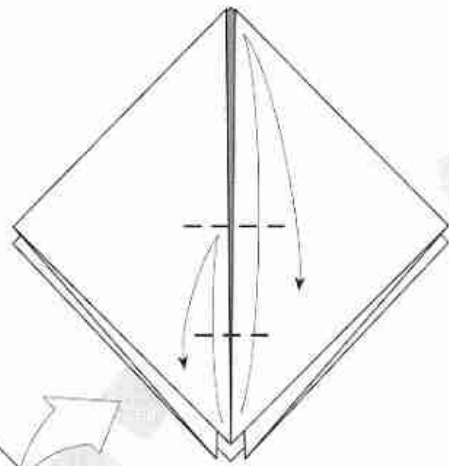

● Blanco
● Negro

□ 20 cm
□ 20 cm

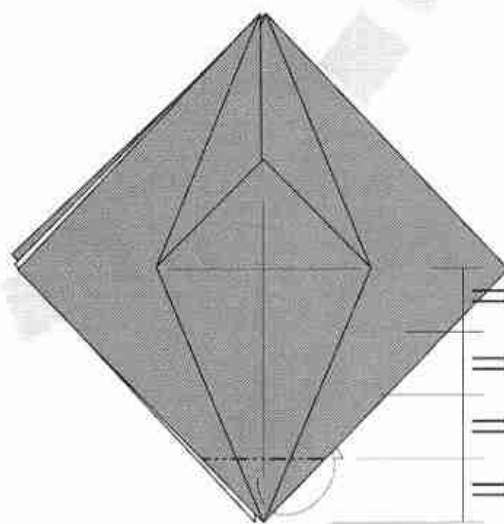
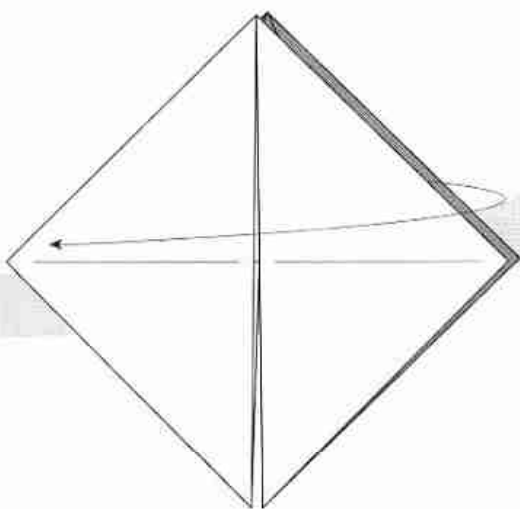

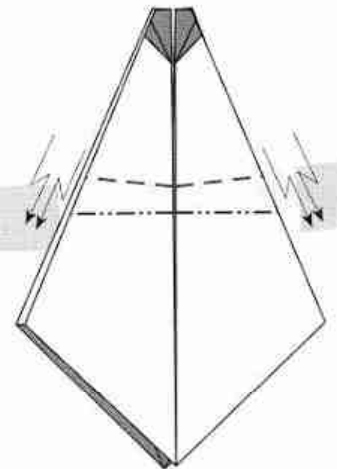
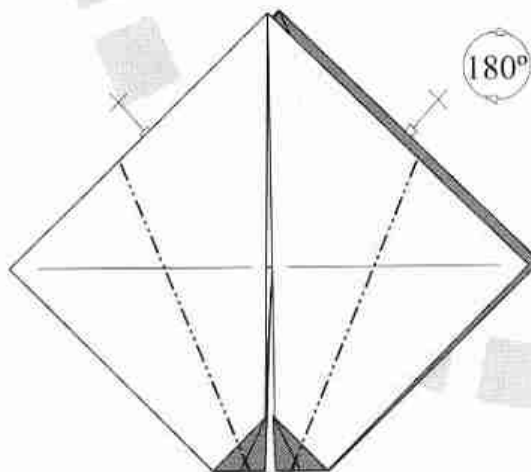
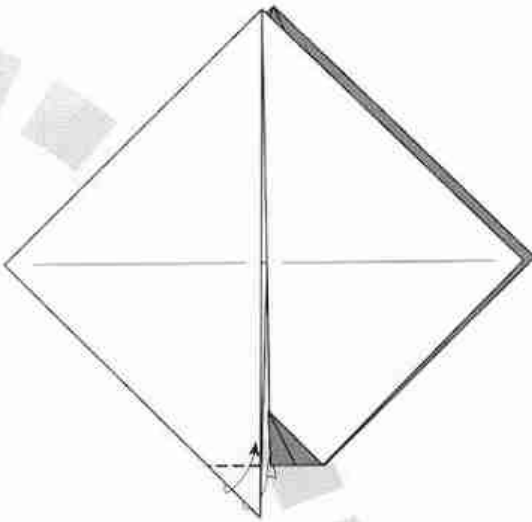
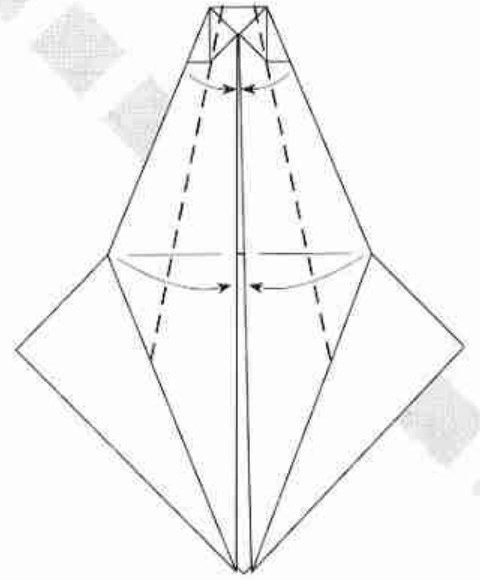
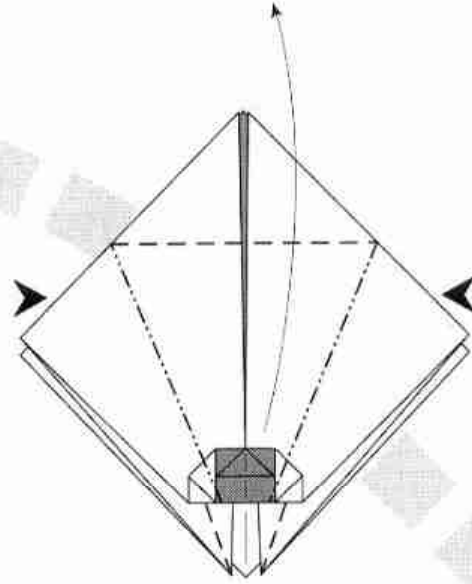
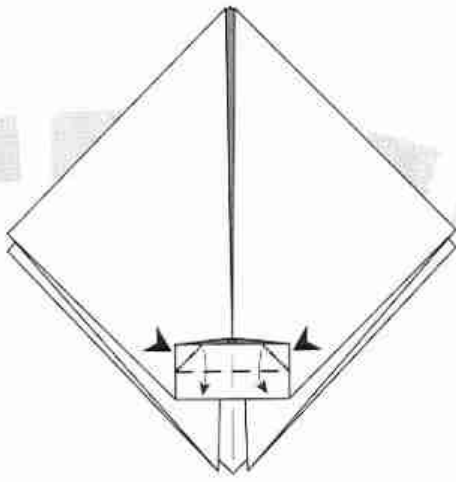

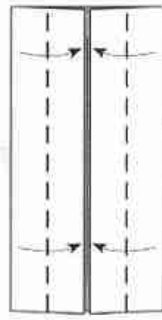
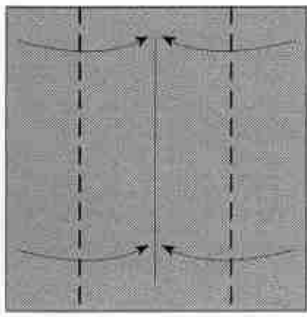

Blanco

10 cm
10 cm

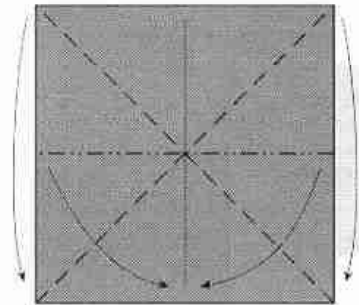
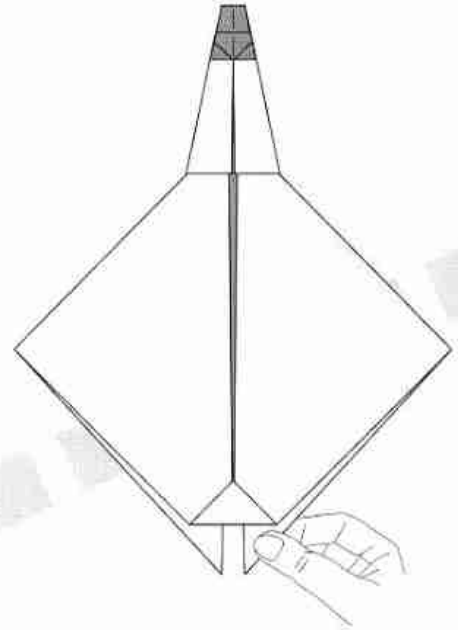
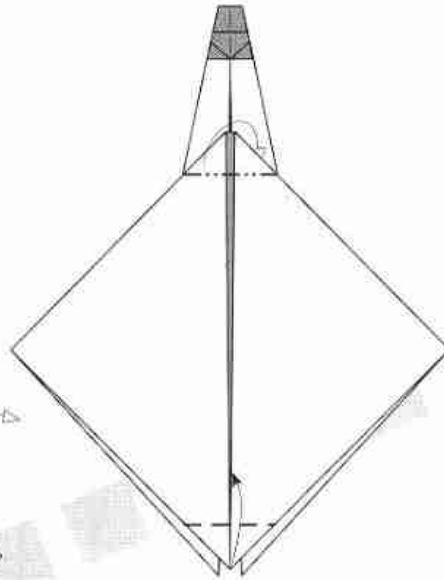
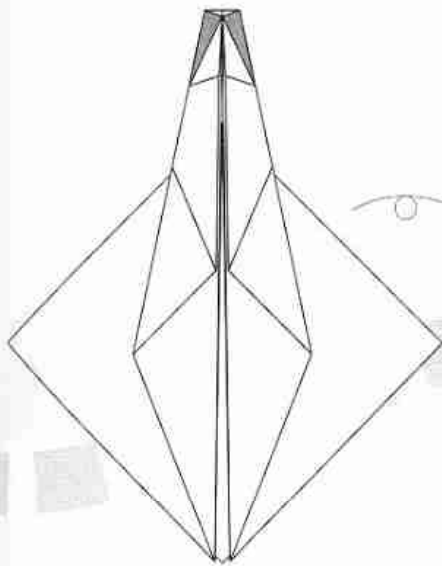

Negro
Blanco

5 cm
5 cm

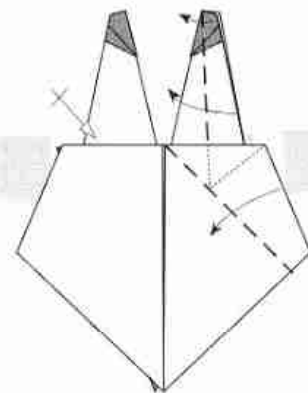
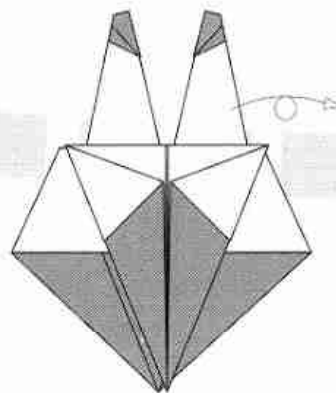
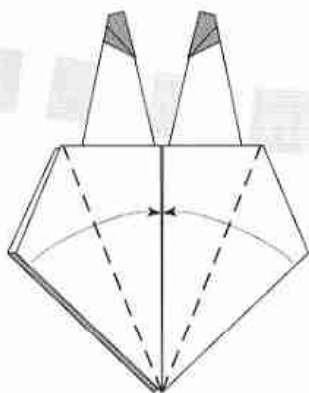
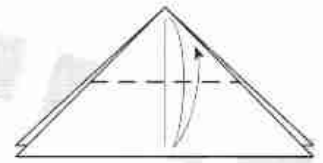

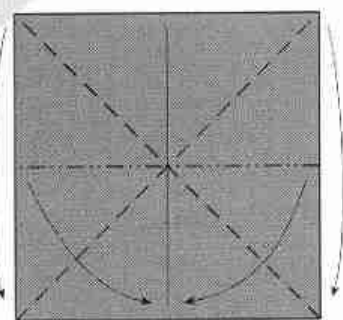
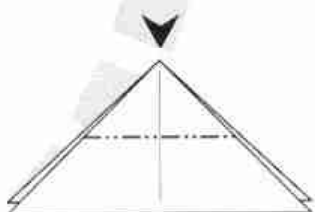
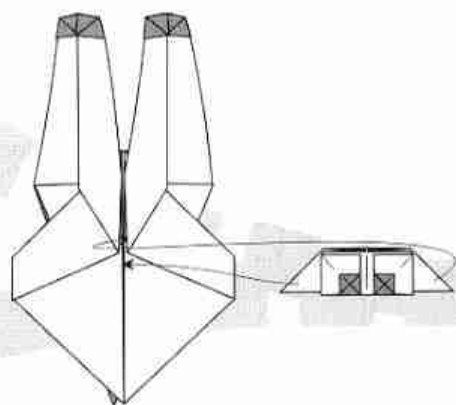
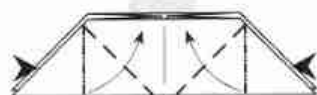
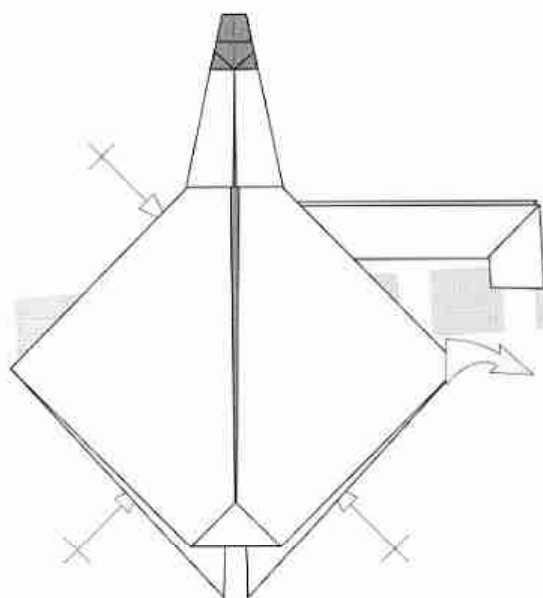
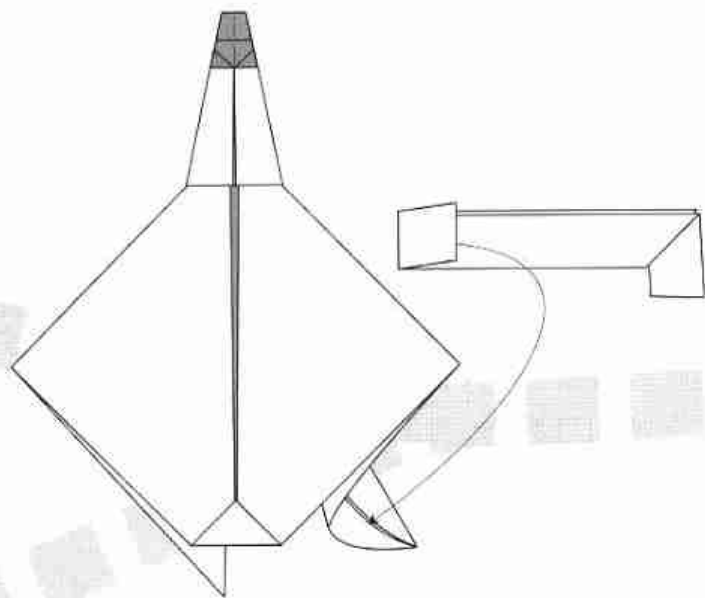

● Negro
○ Blanco

■ 10 cm
□ 10 cm

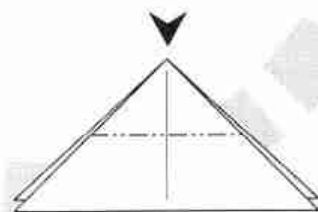
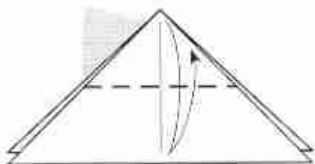
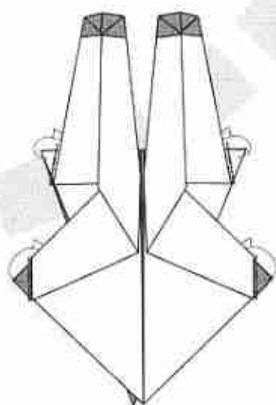

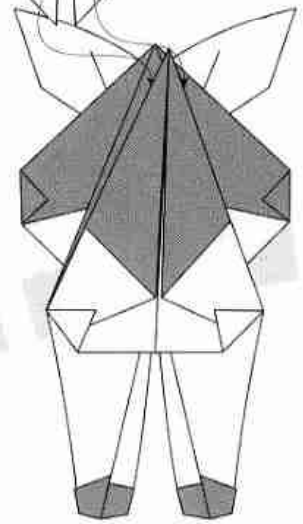
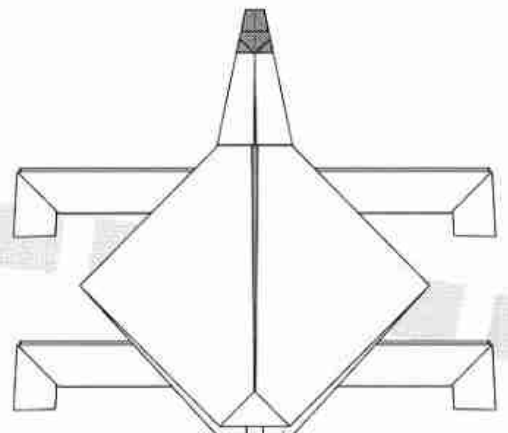
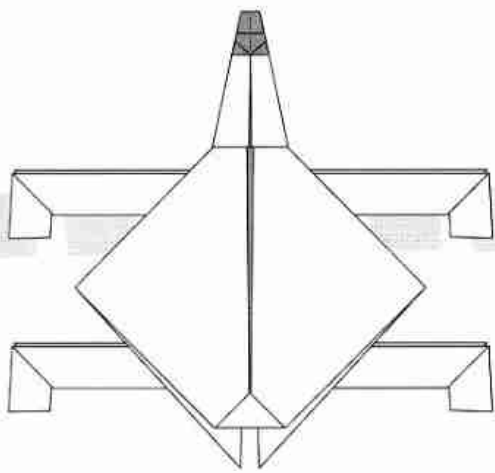

180°

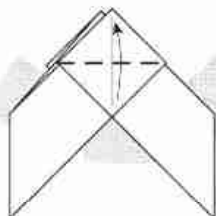
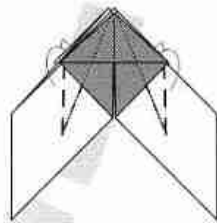
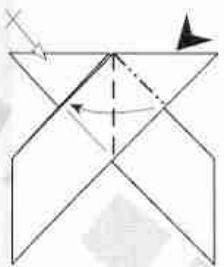
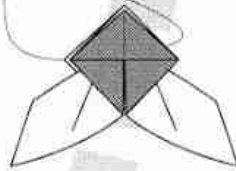
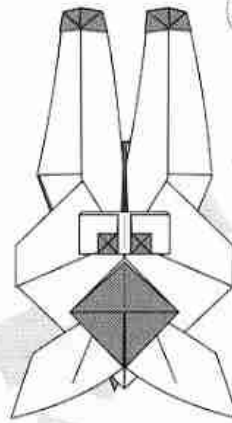
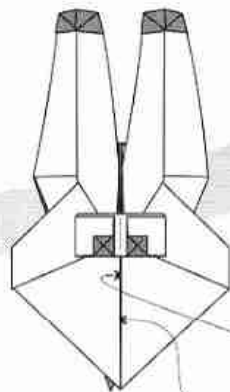
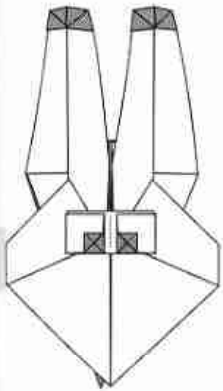

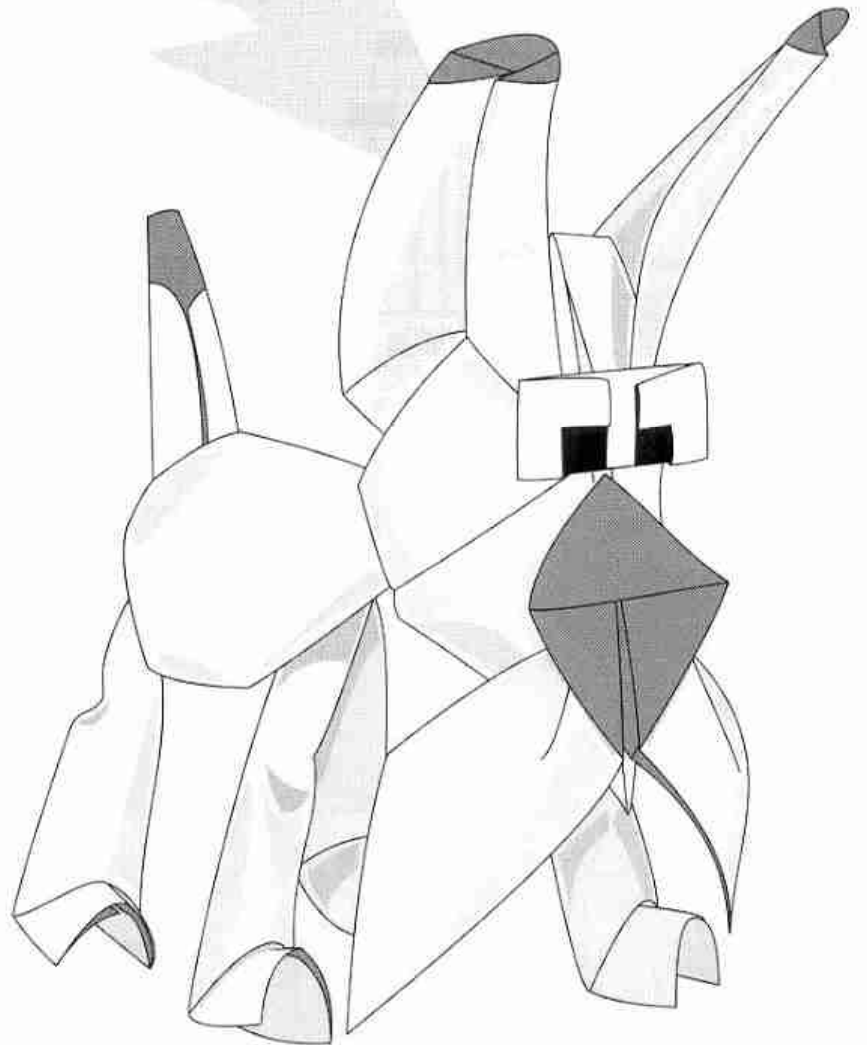
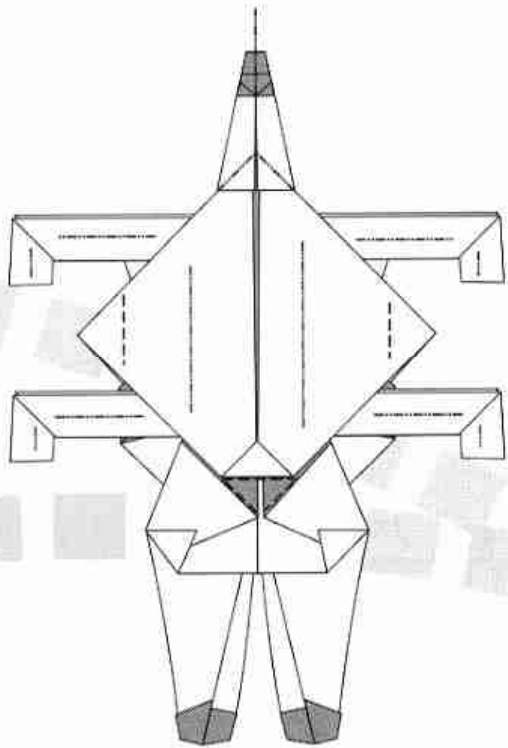

Página (Desarr.)	Pieza nº	Cantidad	Porción	COLORES		Tamaño original	Tamaño 3/10	Tamaño 2/5	Tamaño 3/5
				Anverso	Reverso	18 cm alto Lado (cm) =	5,4 cm alto Lado (cm) =	7,2 cm alto Lado (cm) =	10,8 cm alto Lado (cm) =
32	1	1	Cuerpo	Rojo	Negro	20	6	8	12
32	2	1	Cara + Gorro	Rosa	Blanco	20	6	8	12
33	3	2	Brazos	Neutro	Rosa	10	3	4	6
34	4	2	Piernas	Marrón	Rojo	10	3	4	6
35	5	2	Pelo	Neutro	Amarillo	4	1,2	1,6	2,4
36	6	1	Ojos	Negro	Blanco	4	1,2	1,6	2,4
36	7	1	Detalles cara	Rosa	Amarillo	8	2,4	3,2	4,8

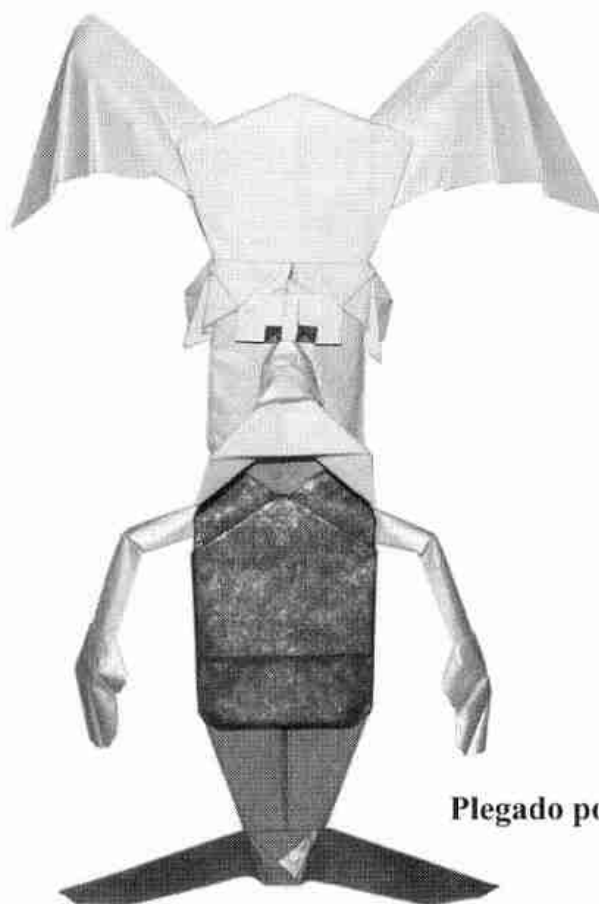

Plegado por: J.A.V.I.

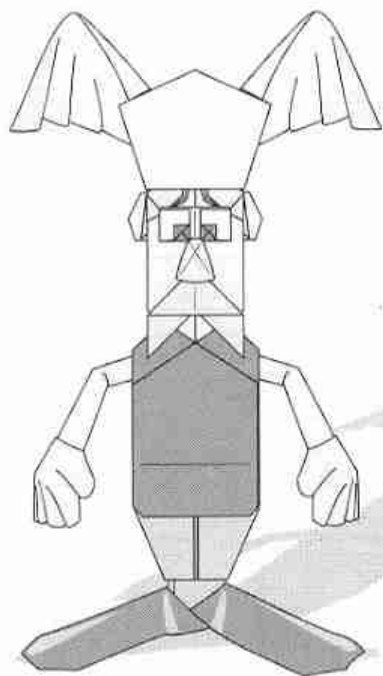

Utilizando las medidas recomendadas, se obtiene un modelo final de 18 cms.

Autor:	Halle
Nivel de dificultad:	Medio-Alto
Número de piezas:	10
Forma de las piezas:	Cuadrados

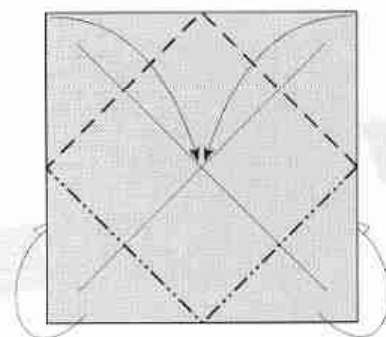
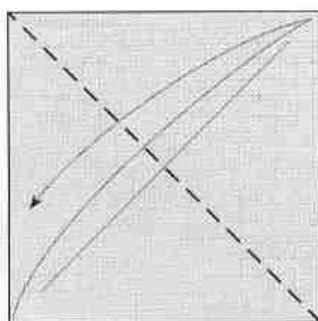
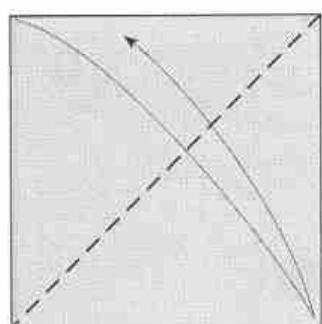

● Rojo
● Negro

□ 20 cm
□ 20 cm

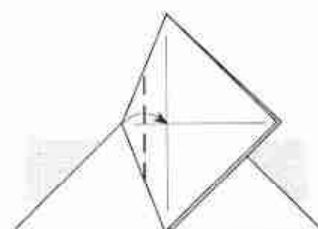
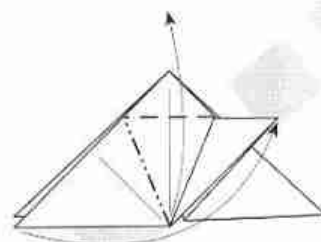
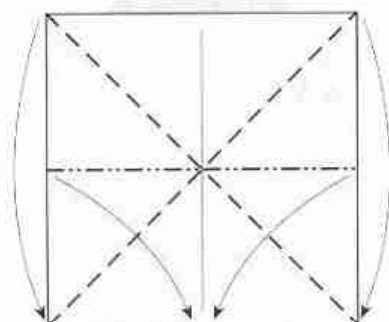
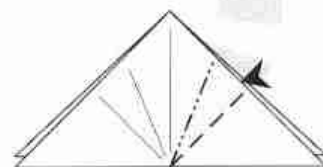
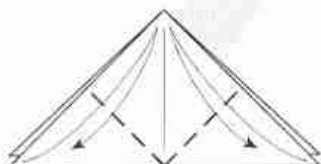
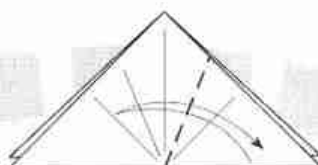
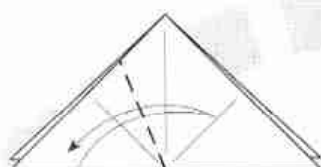

○ Rosa
○ Blanco

□ 20 cm
□ 20 cm



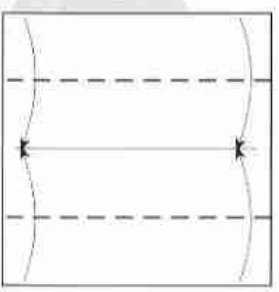
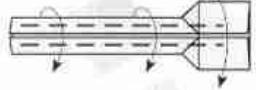
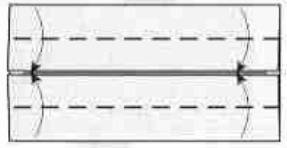
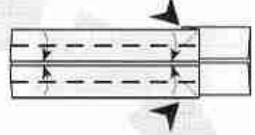
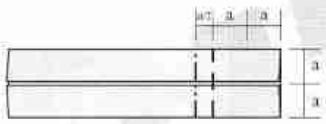
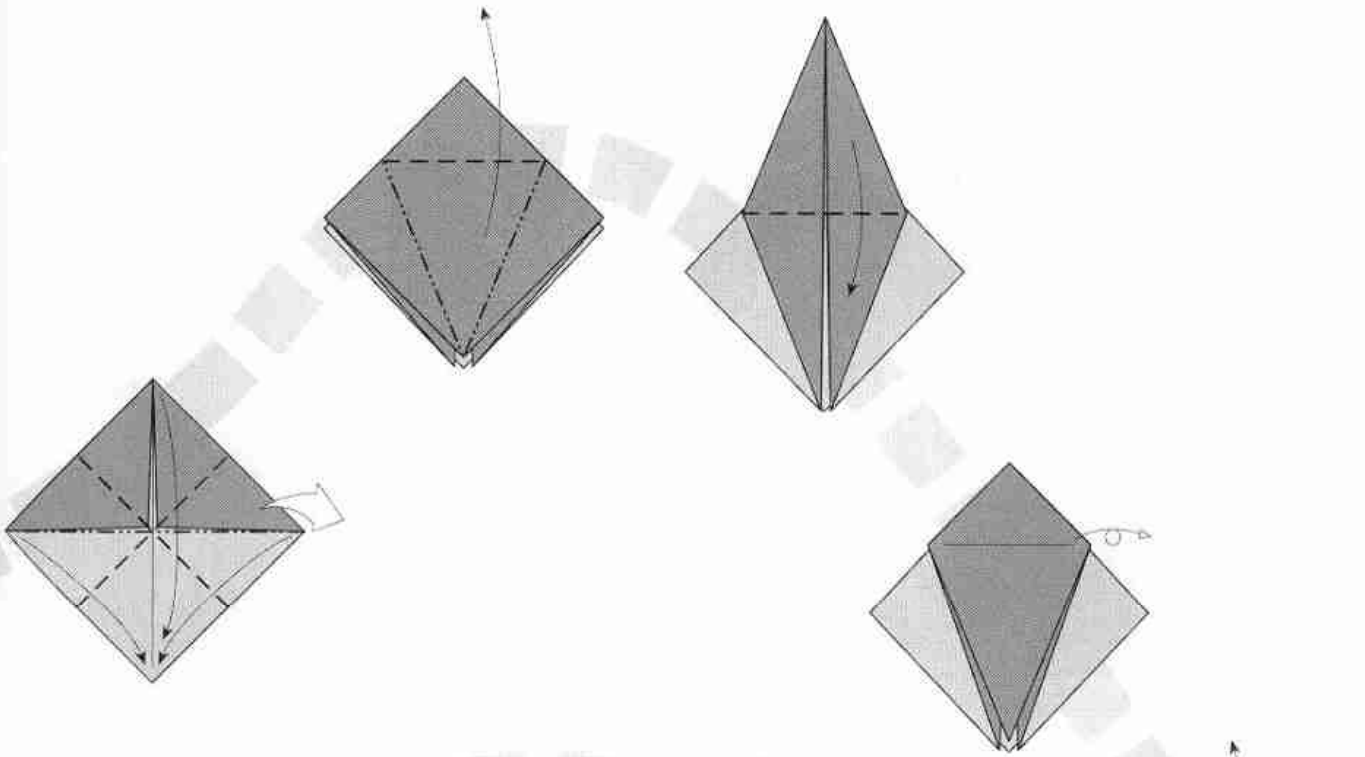

⊖ Rosa □ 10 cm
10 cm

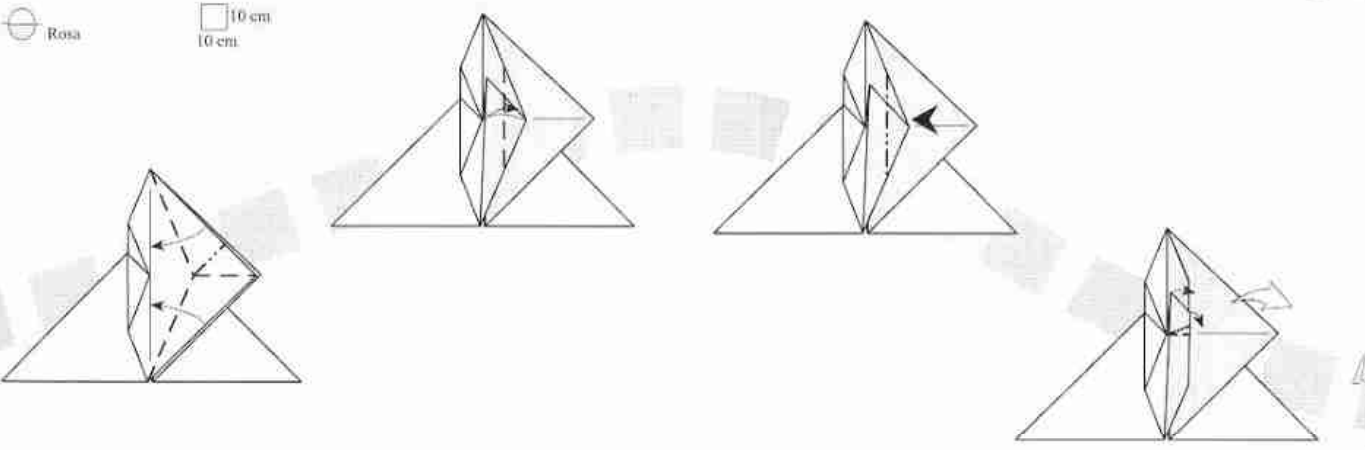
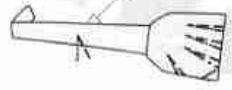

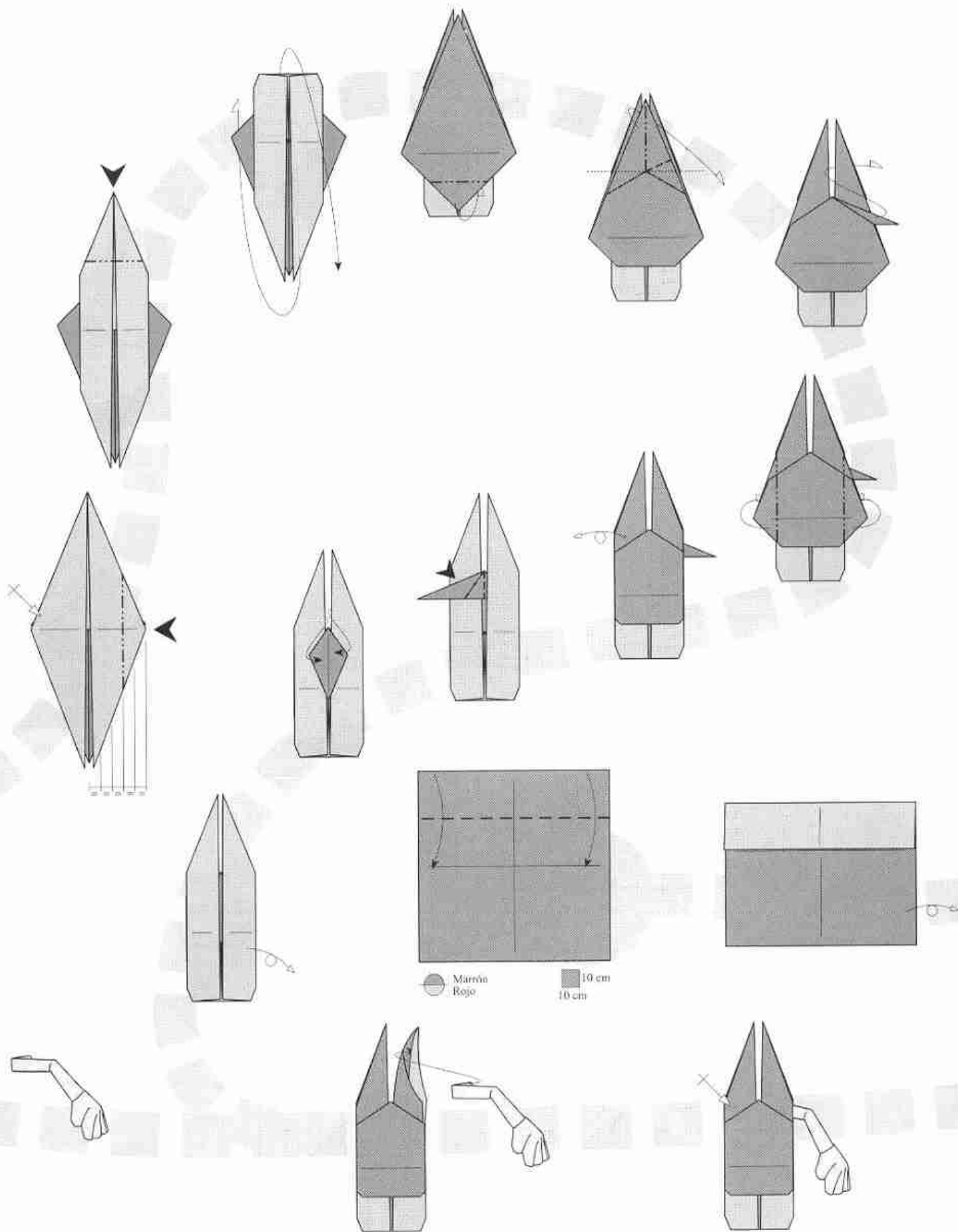

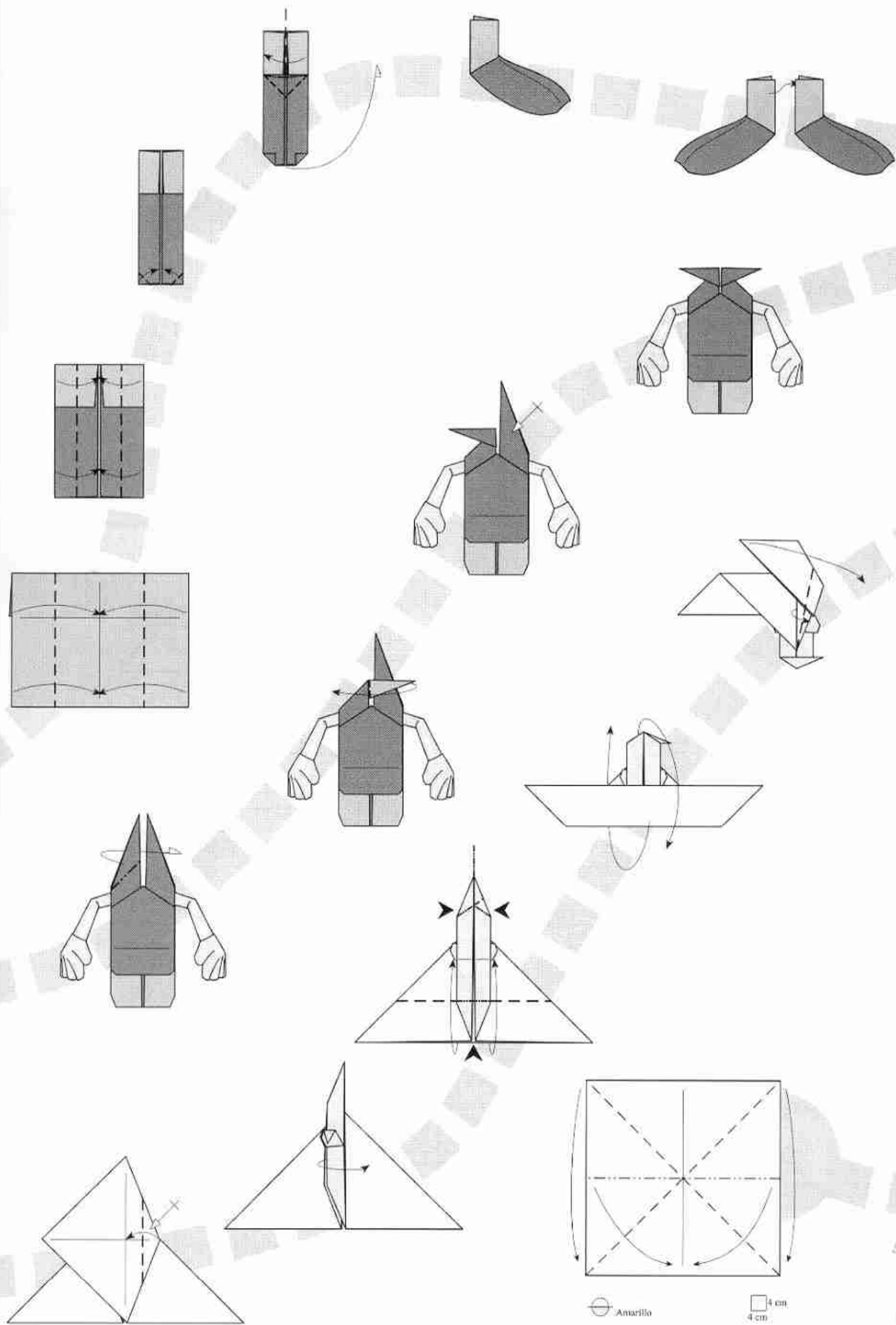

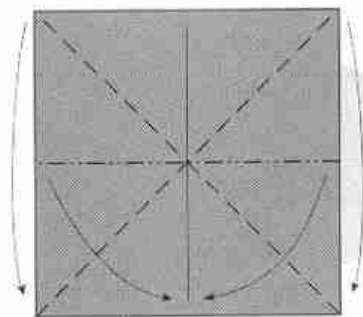
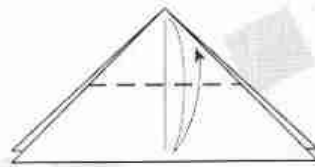
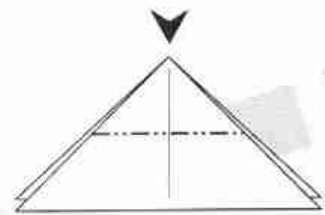
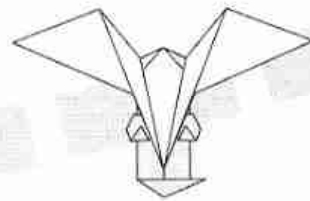
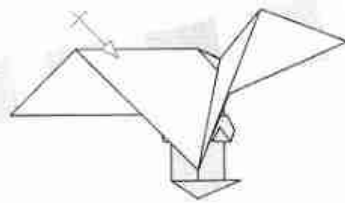
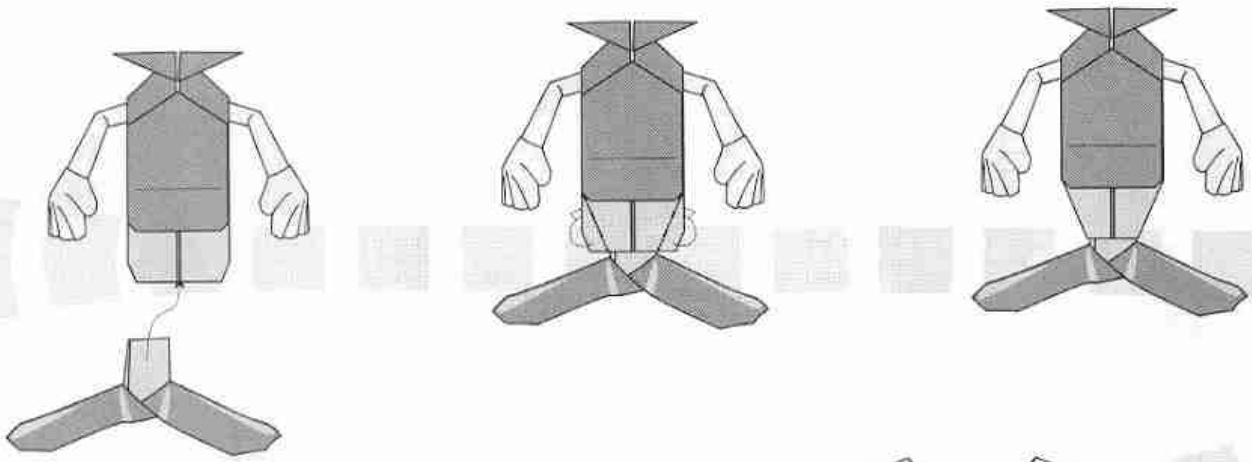

● Negro
● Blanco

■ 4 cm
■ 4 cm

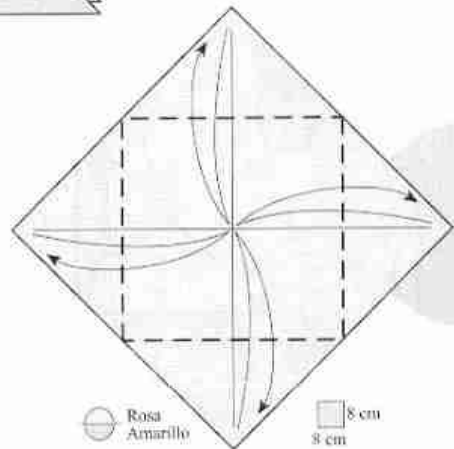
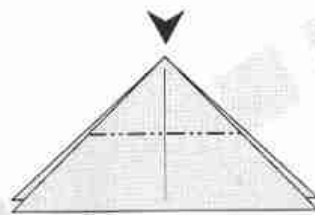

● Rosa
● Amarillo

■ 8 cm
■ 8 cm

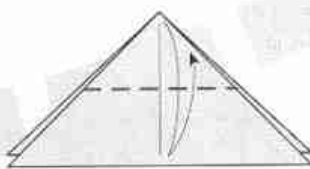

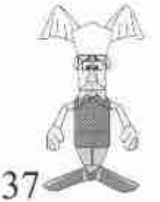
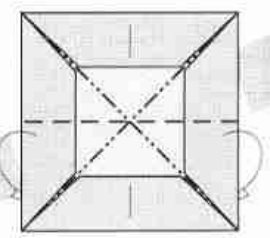
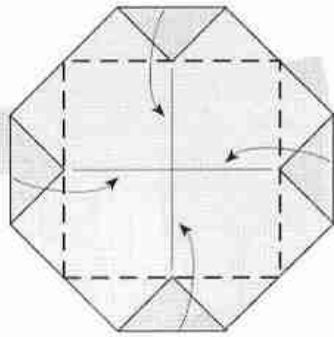
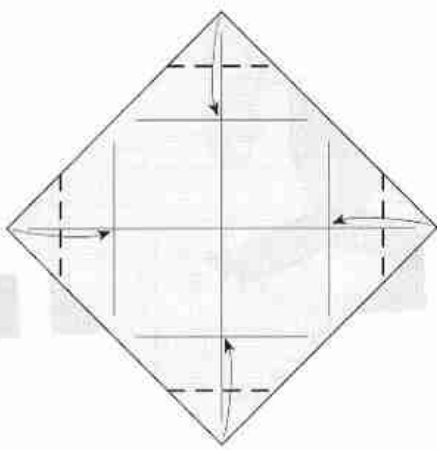
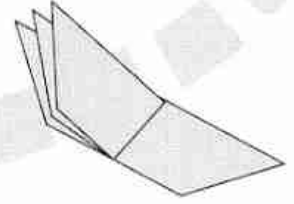
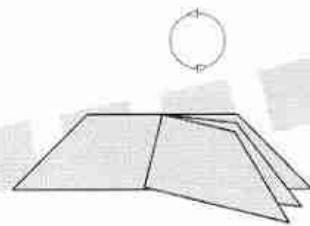
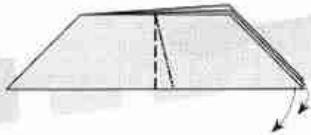
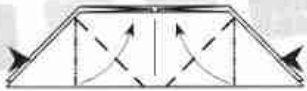
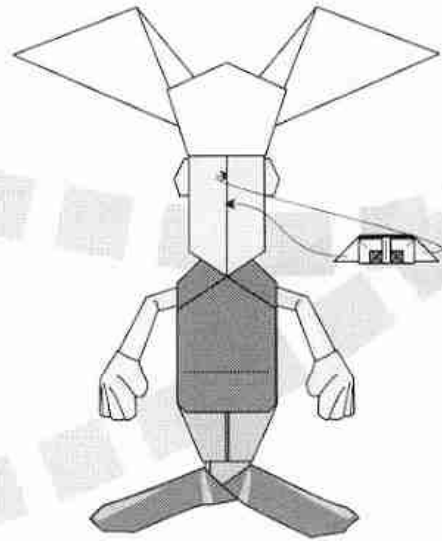
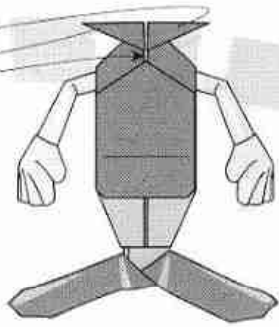
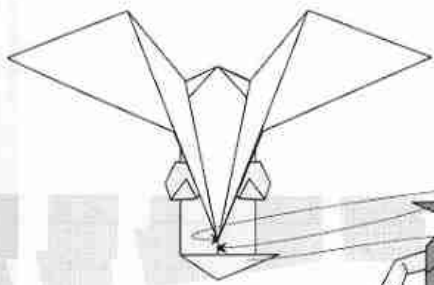

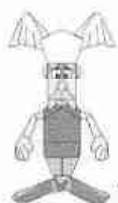
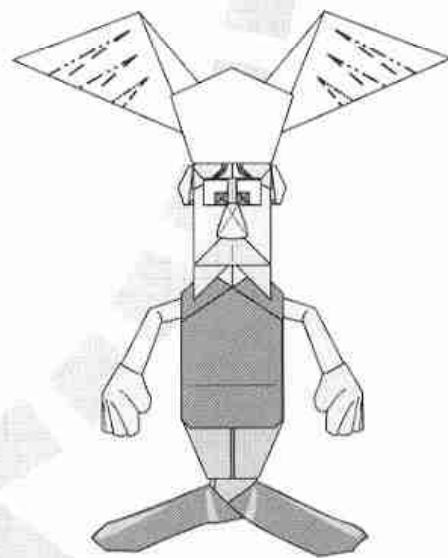
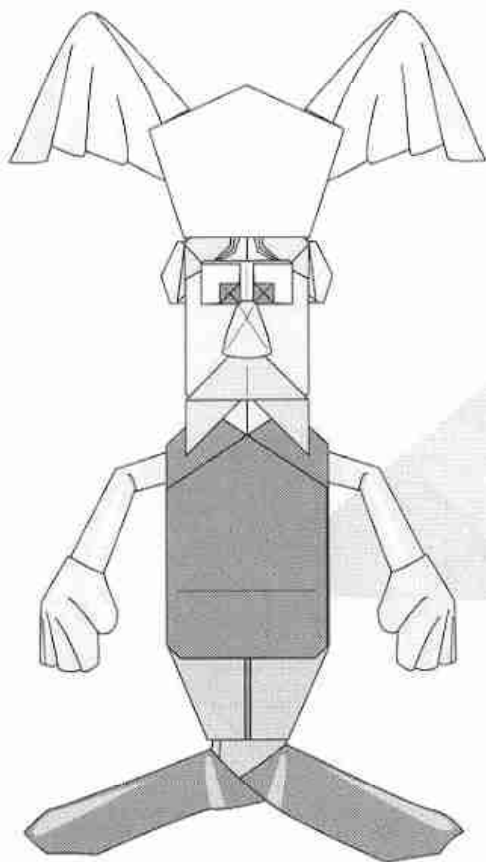
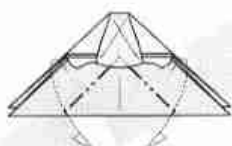
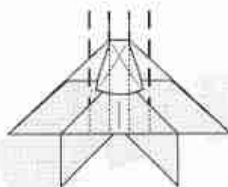
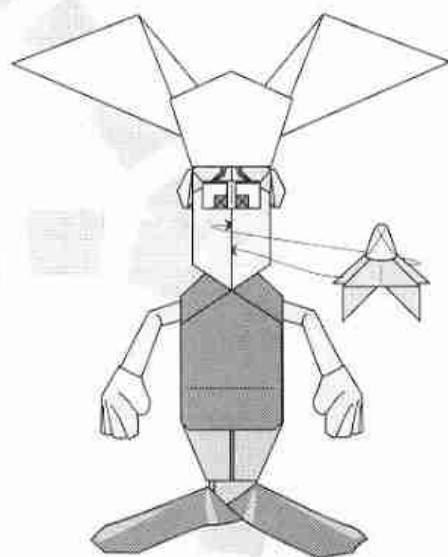
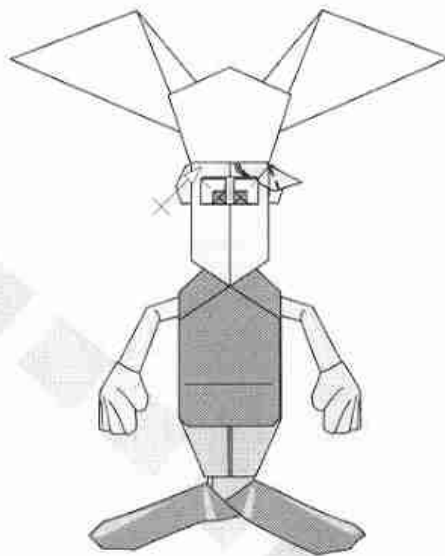
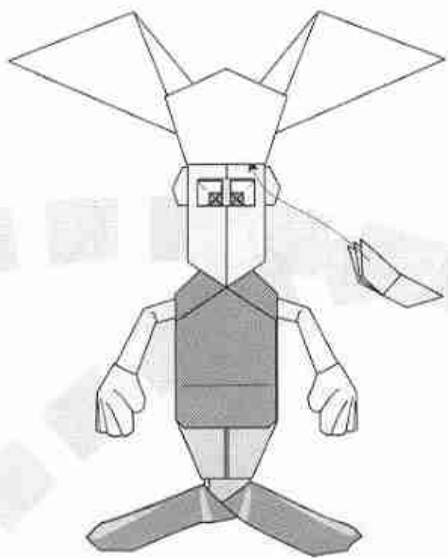

Página	Pieza nº	Cantidad	Porción	COLORES		Tamaño original	Tamaño 2/5	Tamaño 3/5	Tamaño 4/5
				Anverso	Reverso	18 cm alto	7,2 cm alto	10,8 cm alto	14,4 cm alto
						Lado (cm) =	Lado (cm) =	Lado (cm) =	Lado (cm) =
40	1	1	Cuerpo	Negro	Rojo	20	8	12	16
41	2	1	Cabeza/orejas	Neutro	Negro	20	8	12	16
41	3	1	Base cara	Neutro	Bianco	20	8	12	16
42	4	1	Corbata	Neutro	Negro	7,5	3	4,5	6
44	5	1	Nariz	Neutro	Negro	5	2	3	4
45	6	1	Boca	Neutro	Negro	5	2	3	4
45	7	1	Ojos	Negro	Bianco	5	2	3	4
42	8	1	Brazos	Rojo	Negro	20	8	12	16
47	9	2	Manos	Gris	Bianco	7,5	3	4,5	6
48	10	2	Pies	Gris	Bianco	7,5	3	4,5	6

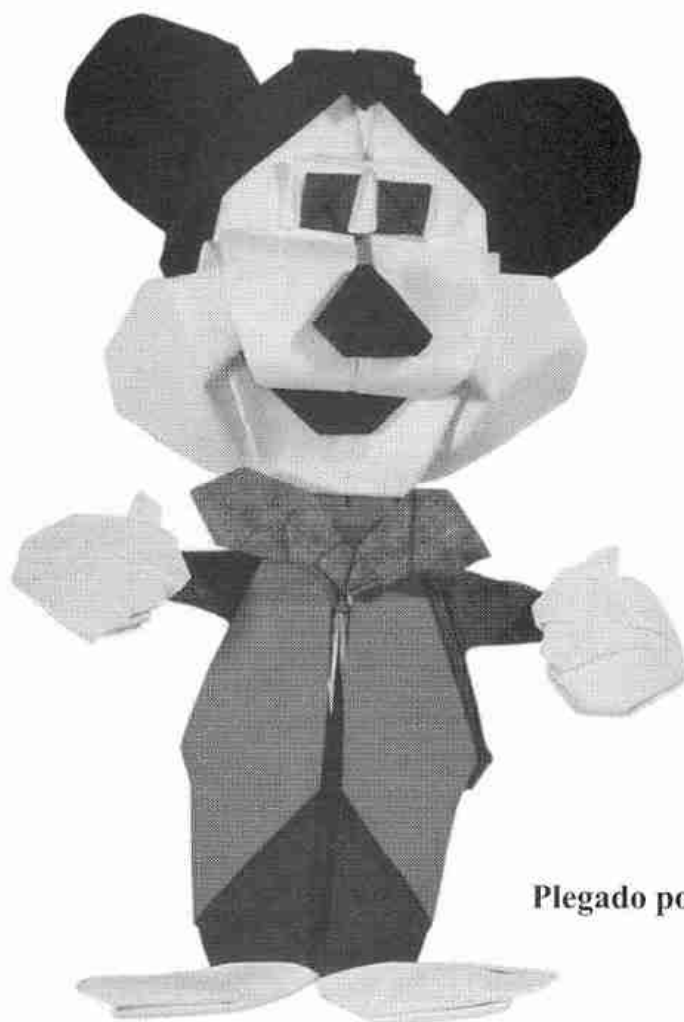

Plegado por: Halle

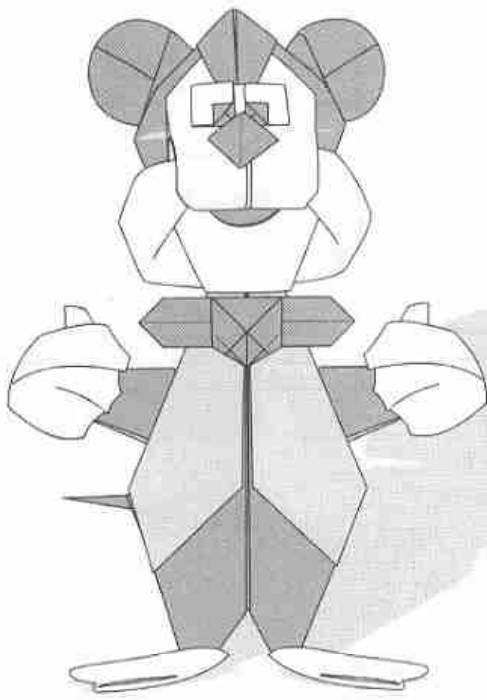

Utilizando las medidas recomendadas, se obtiene un modelo final de 18 cms.

Autor:	Halle
Nivel de dificultad:	Medio
Número de piezas:	12
Forma de las piezas:	Cuadrados

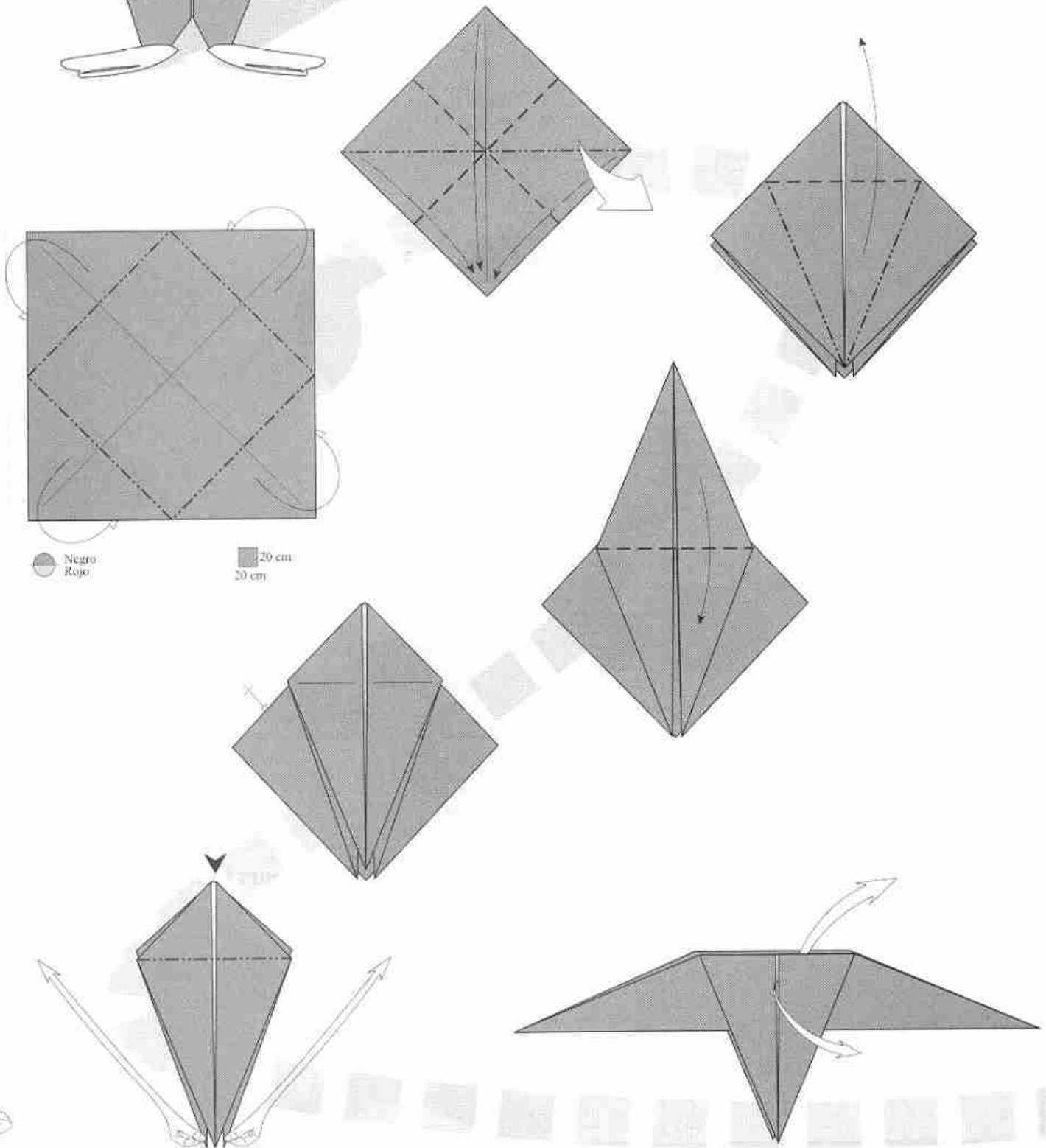

● Negro
● Rojo

■ 20 cm
■ 20 cm



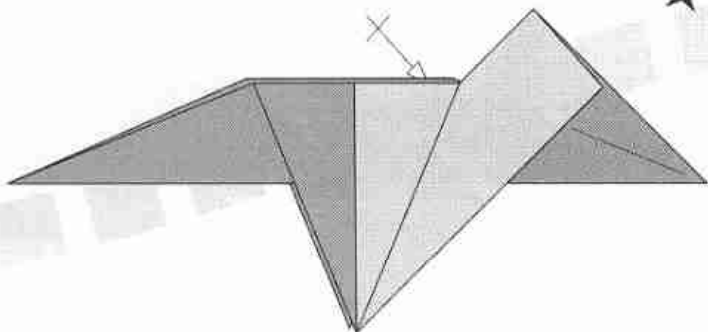
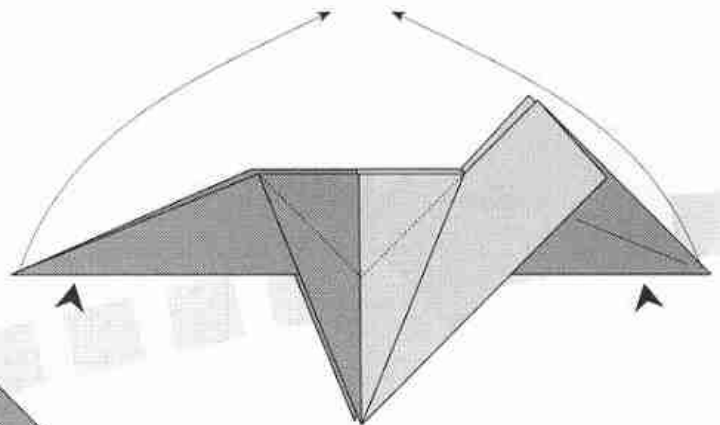
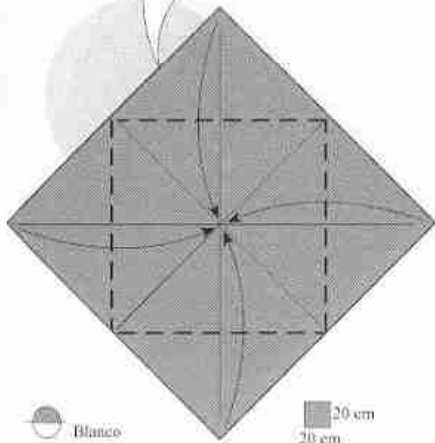
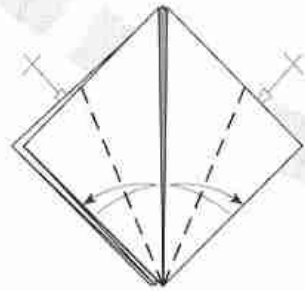
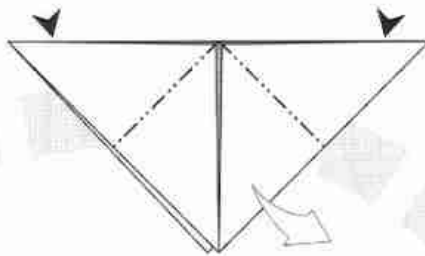
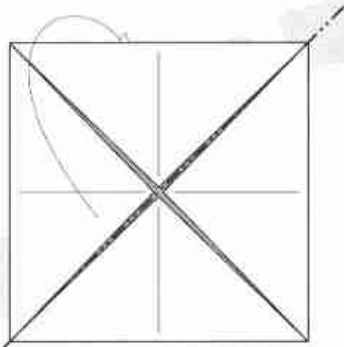
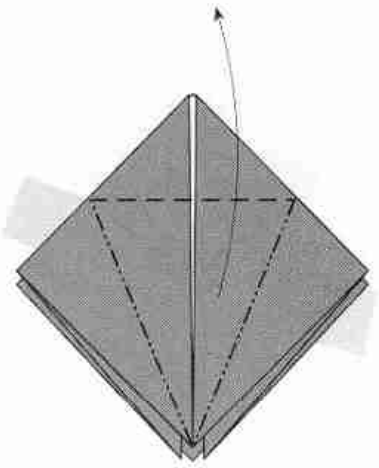
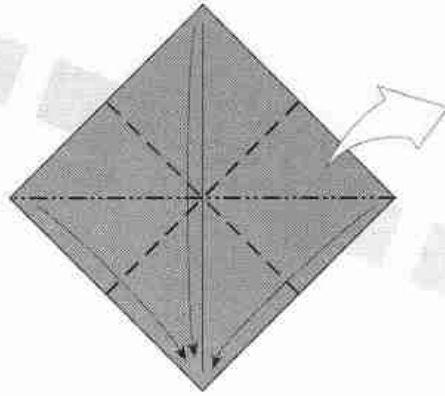
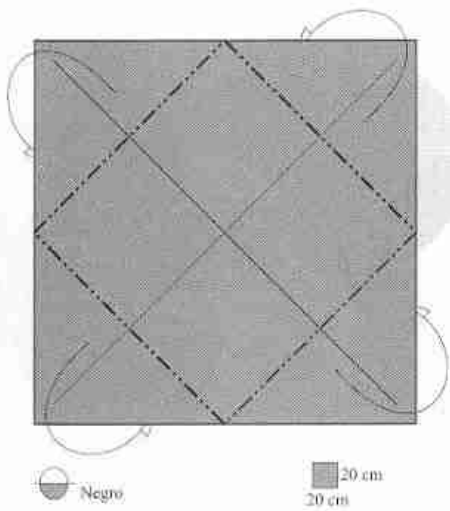

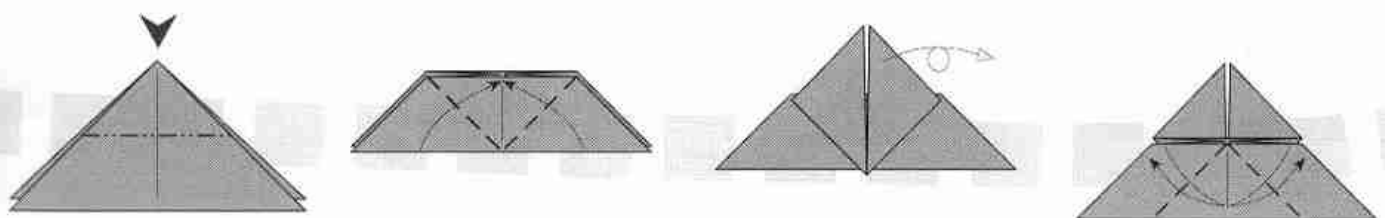
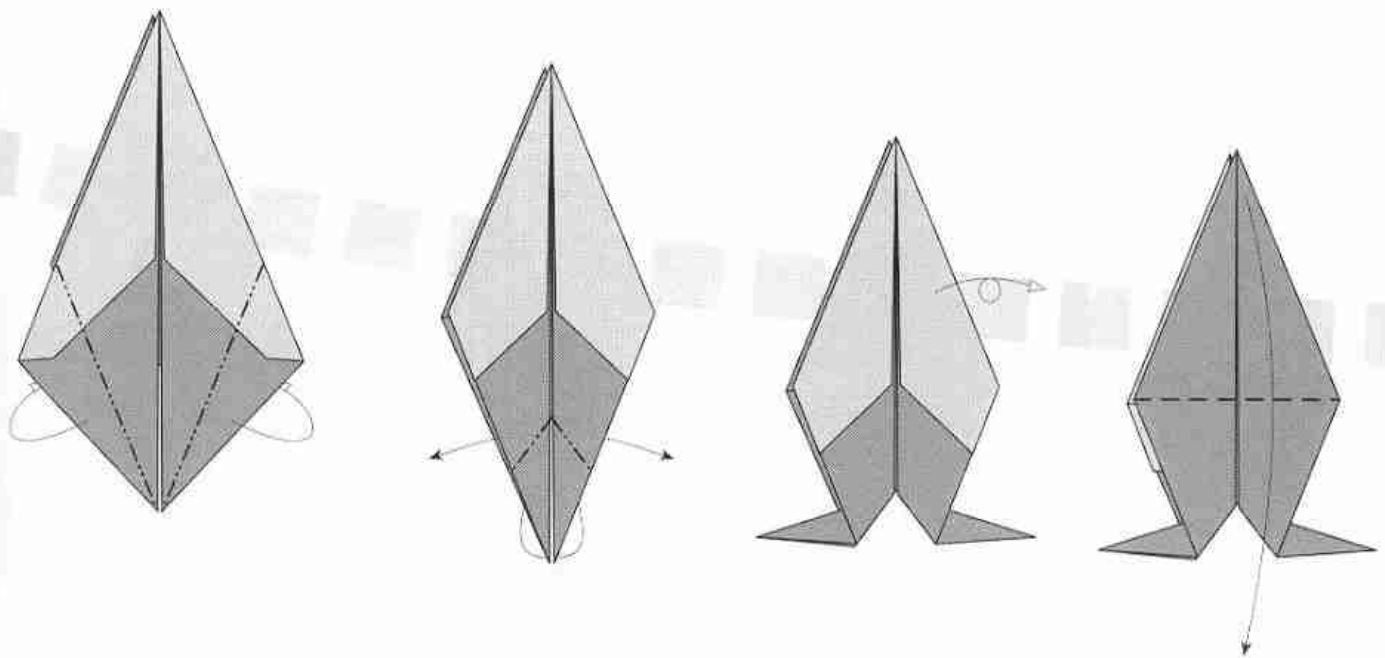
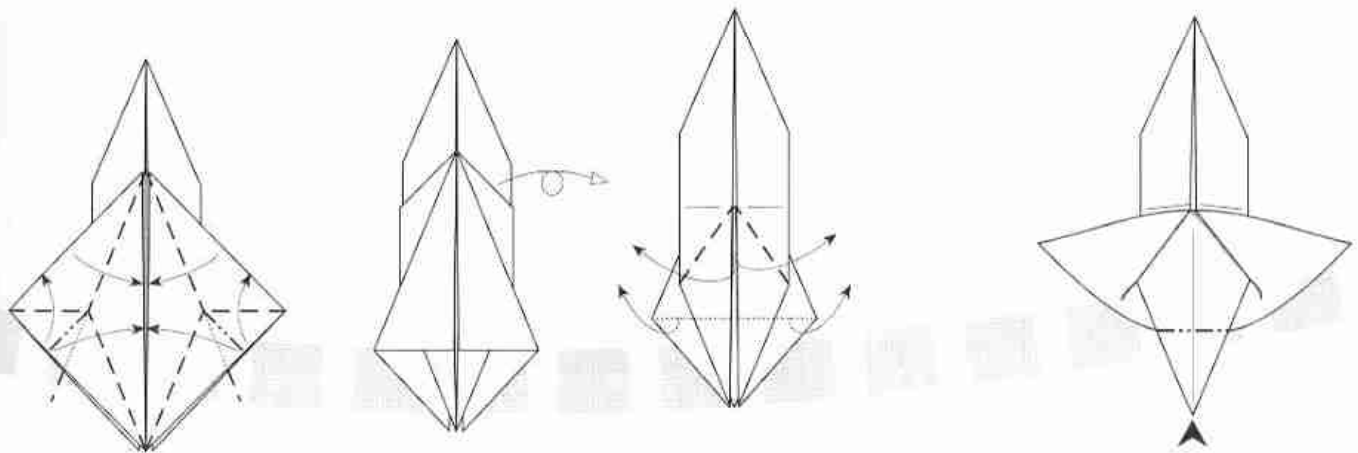
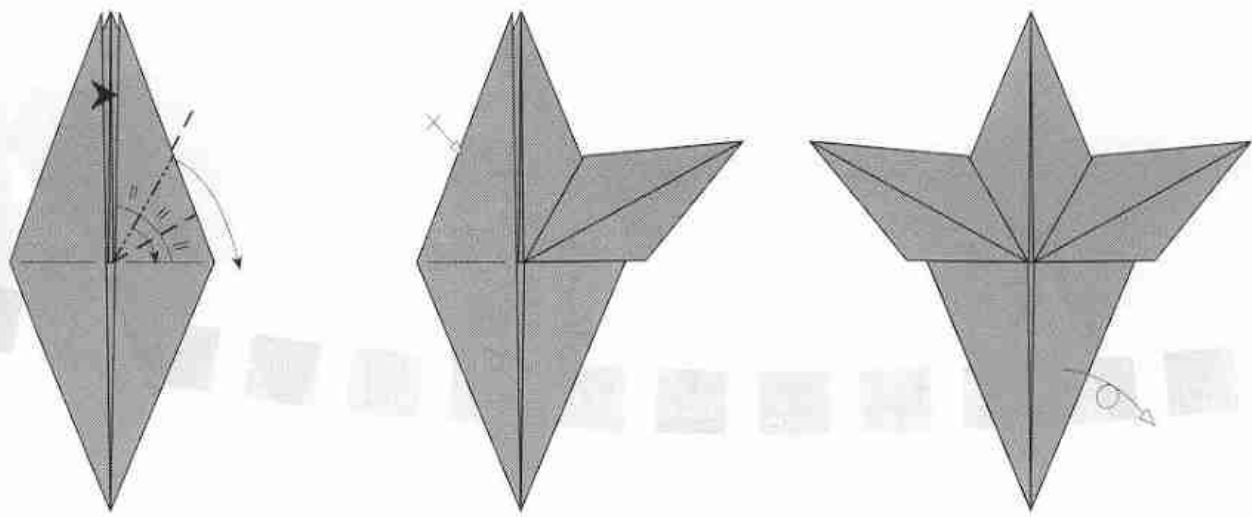

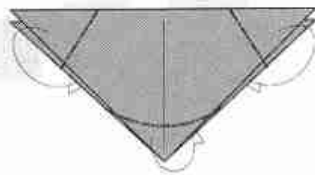
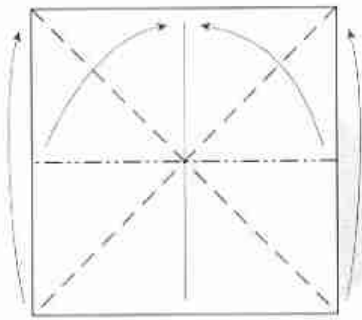
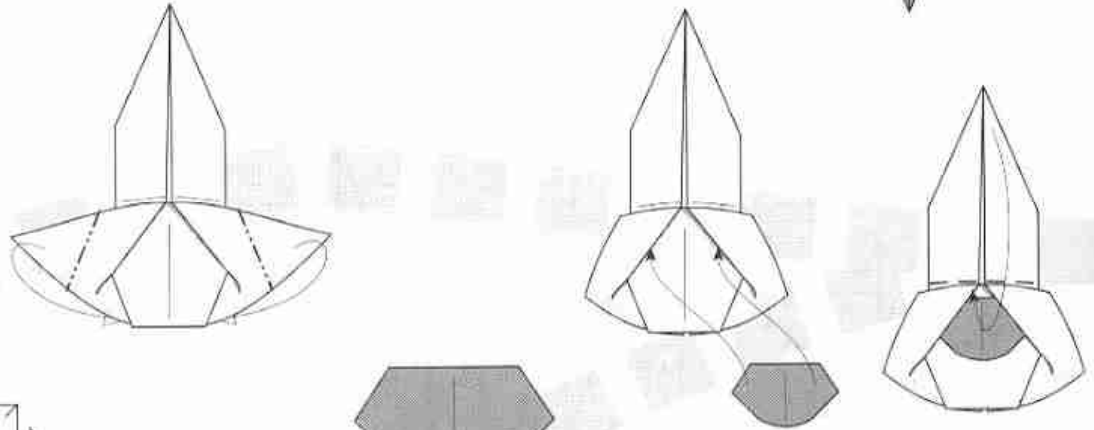
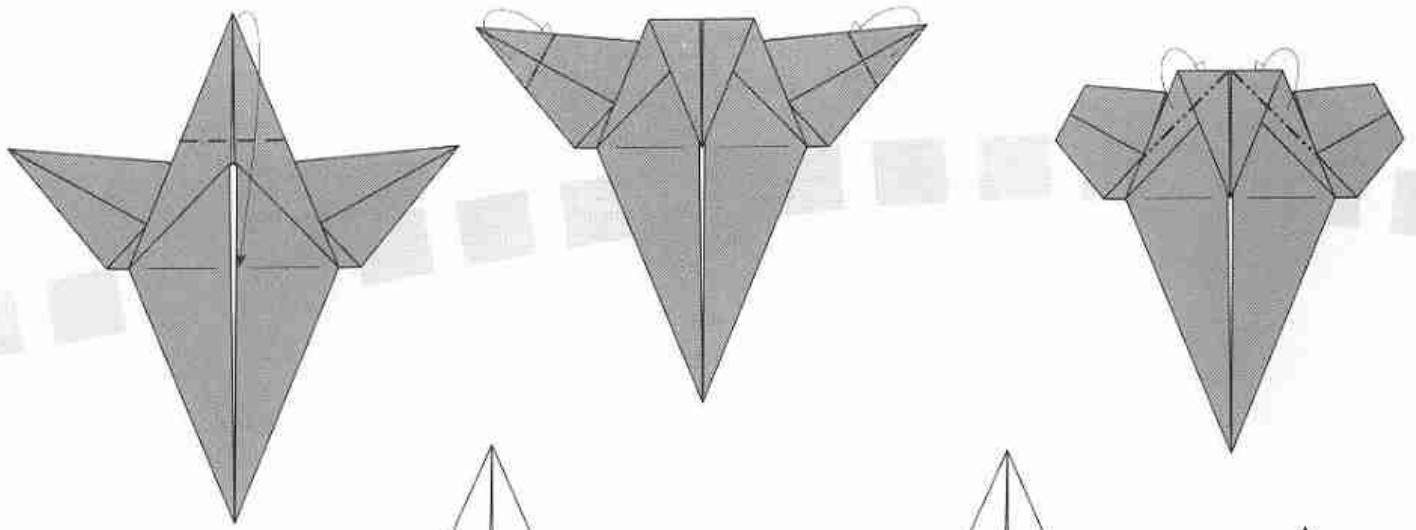

● Negro

5 cm
5 cm

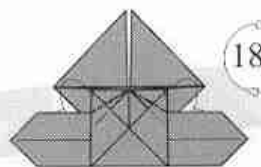
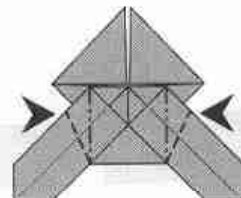
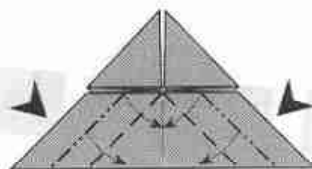
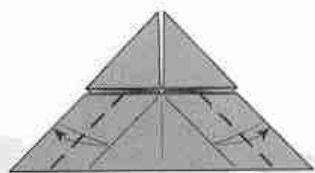
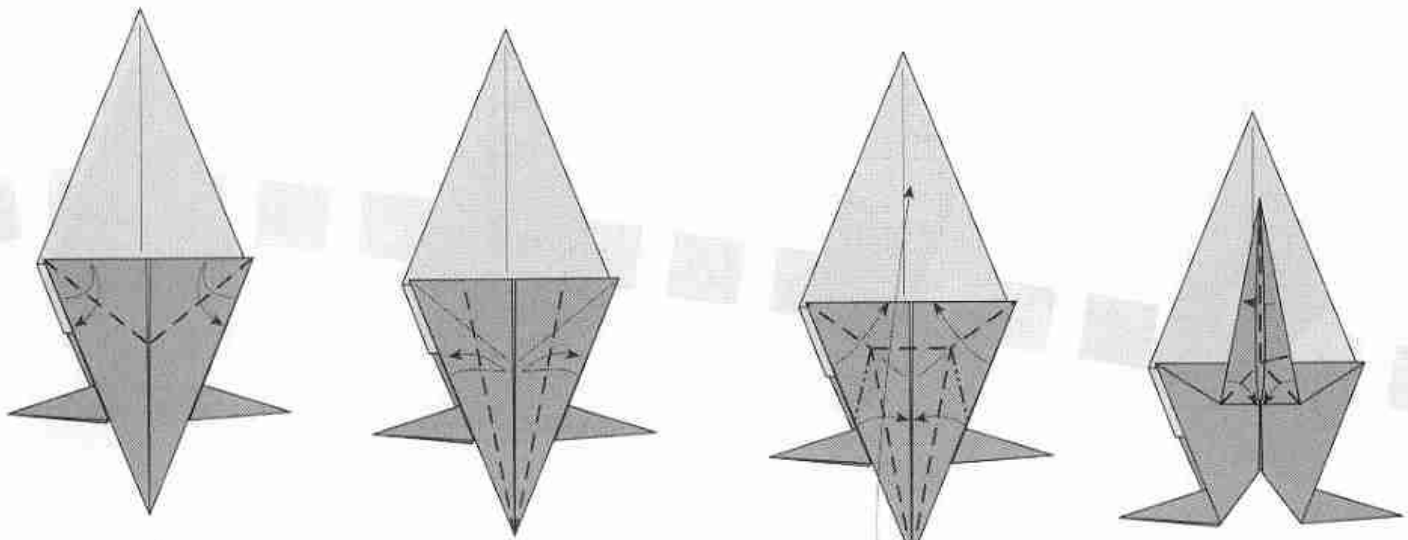

180°



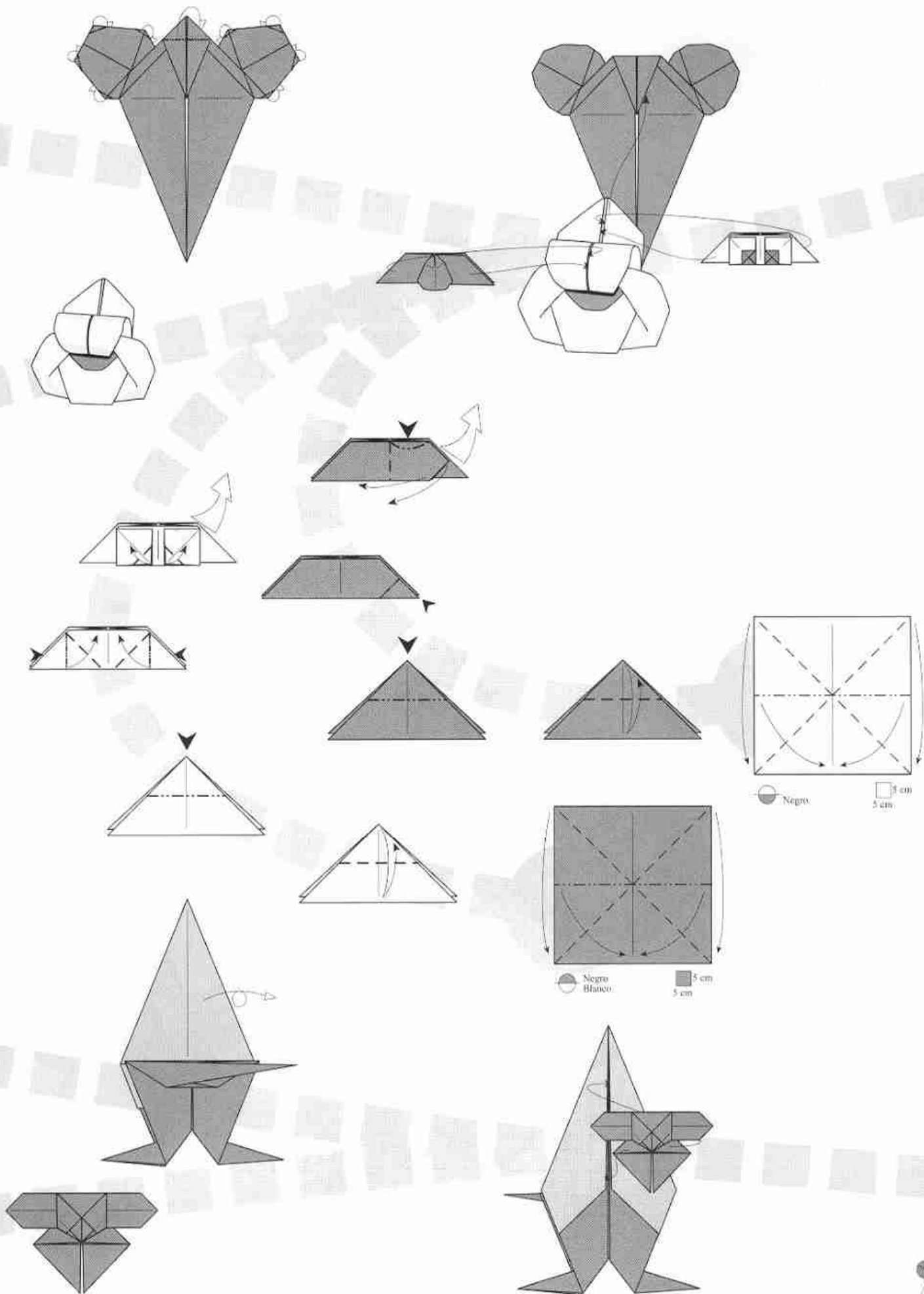

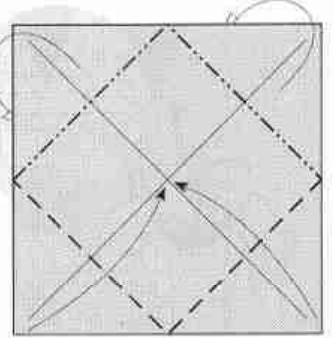
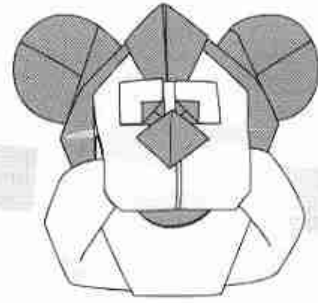
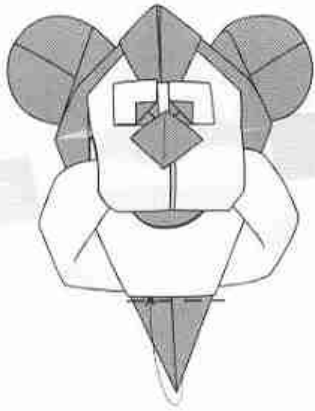

● Rojo
● Negro

□ 20 cm
□ 20 cm

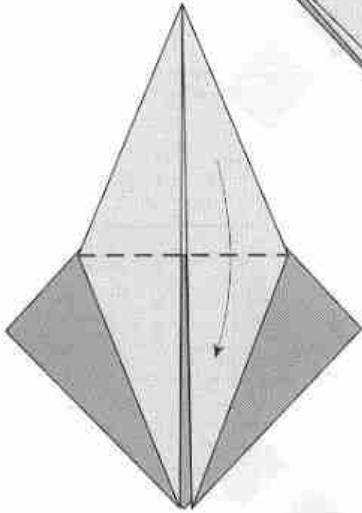
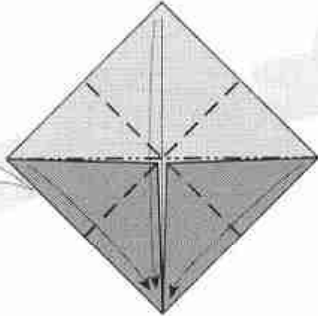
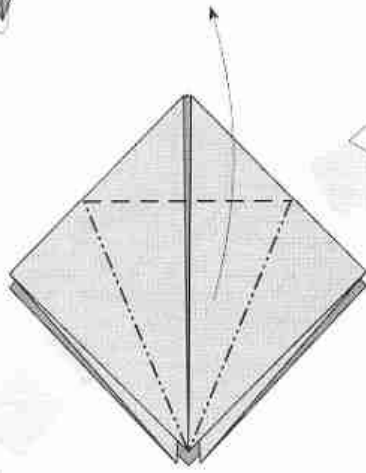

180°

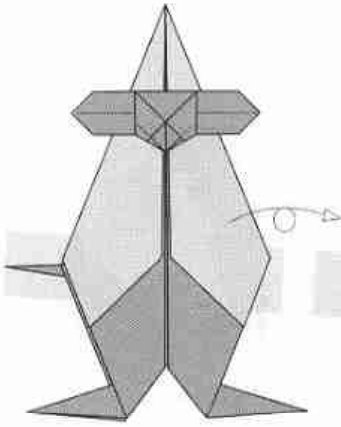
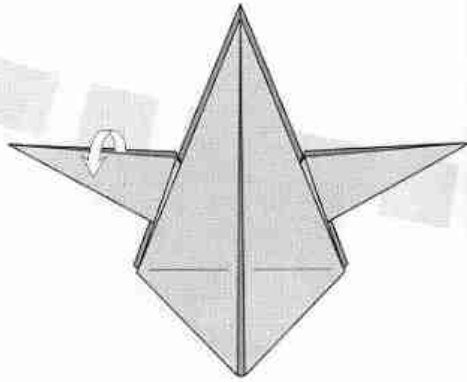
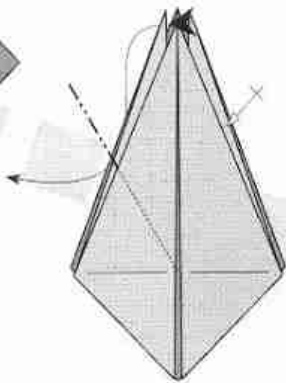
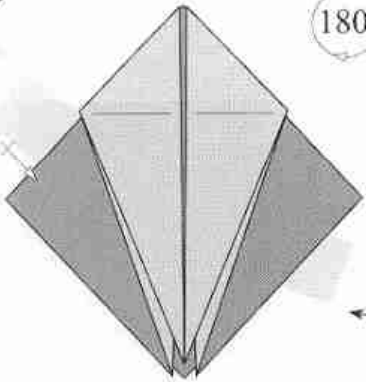

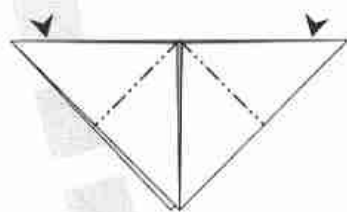
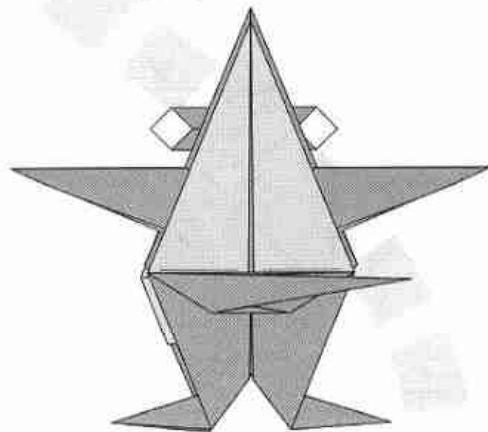
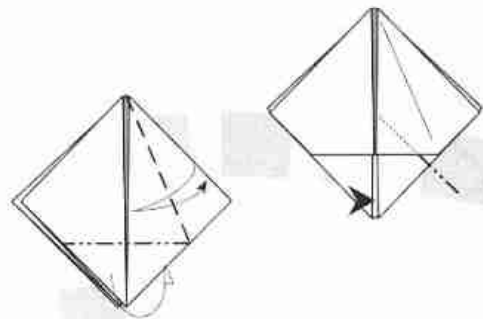
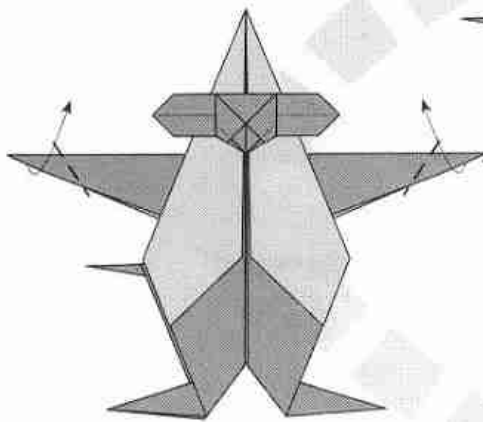
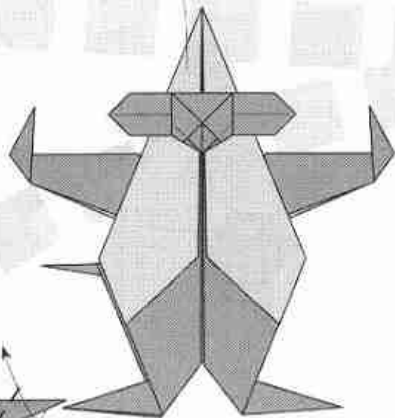
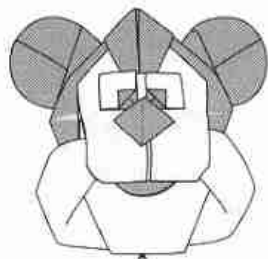

45°

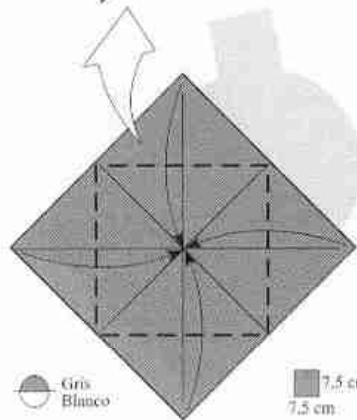
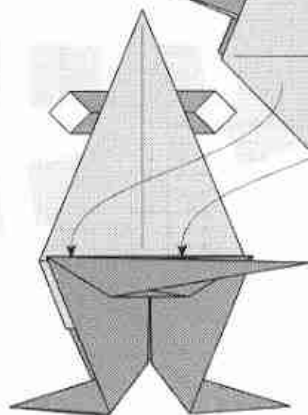
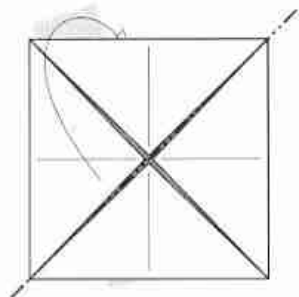
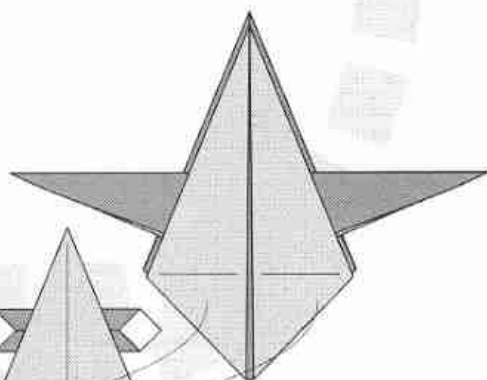
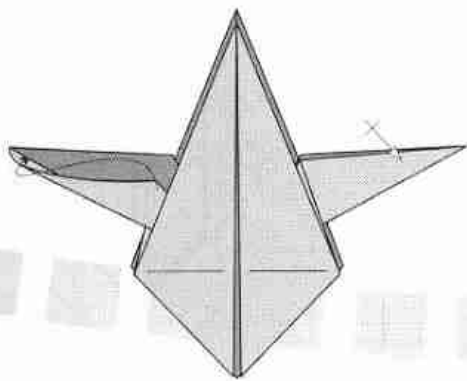

● Gris
● Blanco

■ 7,5 cm
■ 7,5 cm



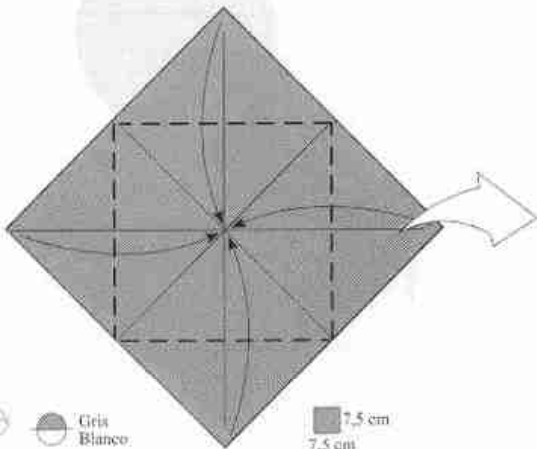
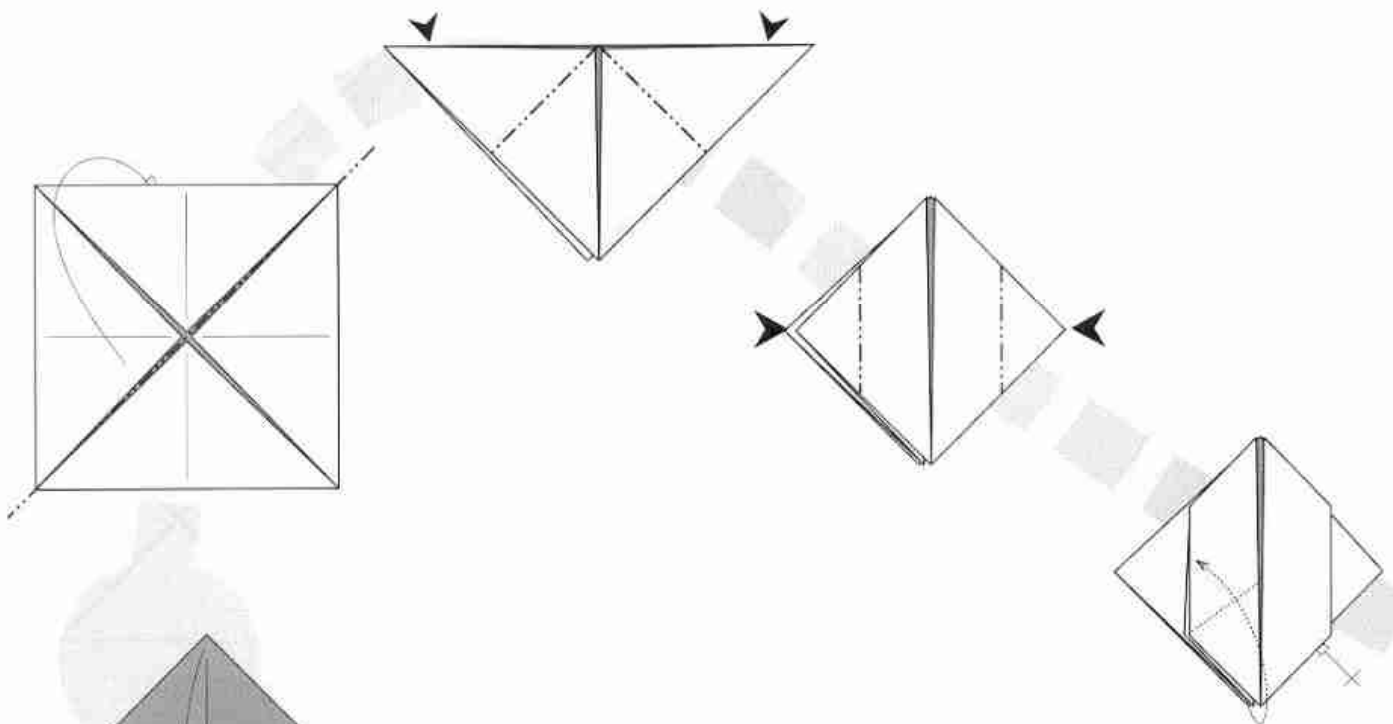
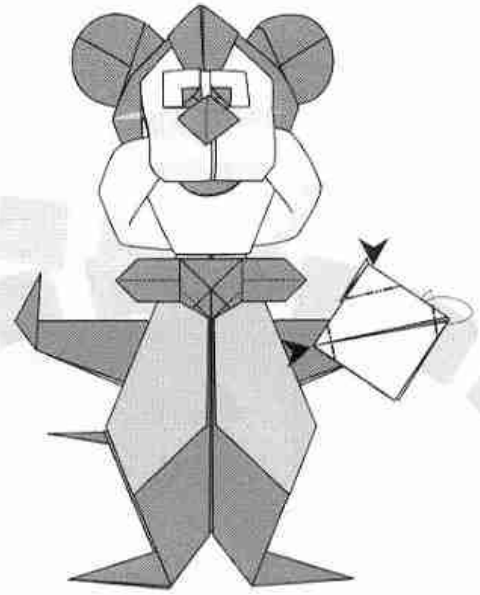
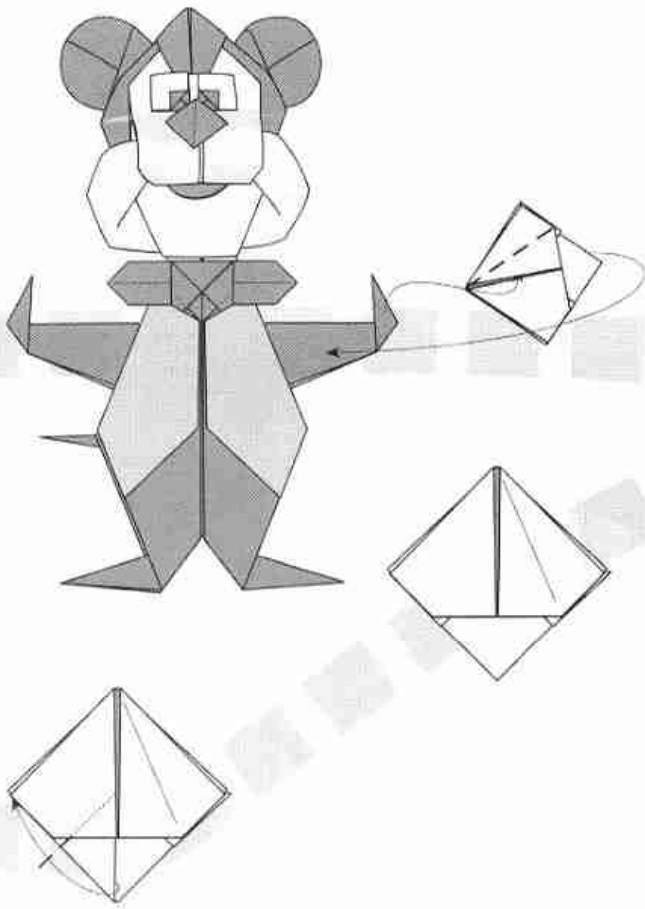

● Gris
● Blanco

■ 7,5 cm
■ 7,5 cm

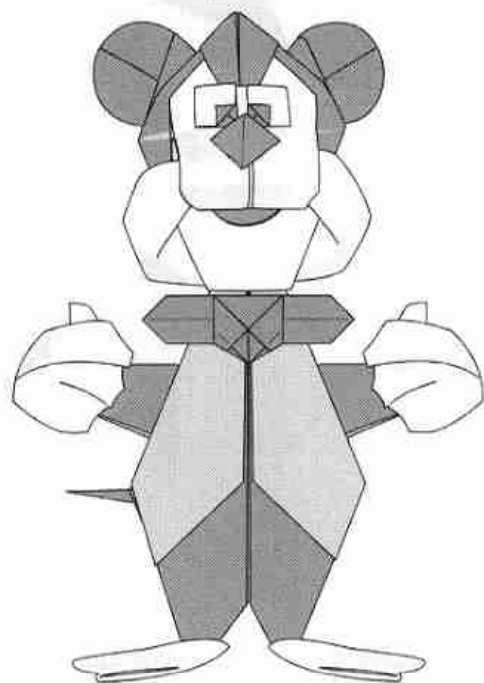
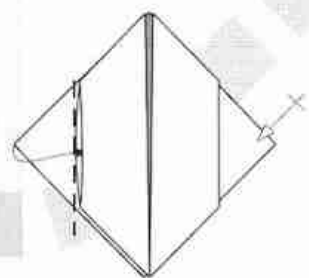
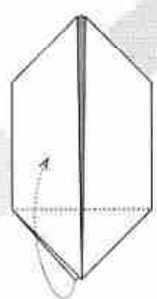
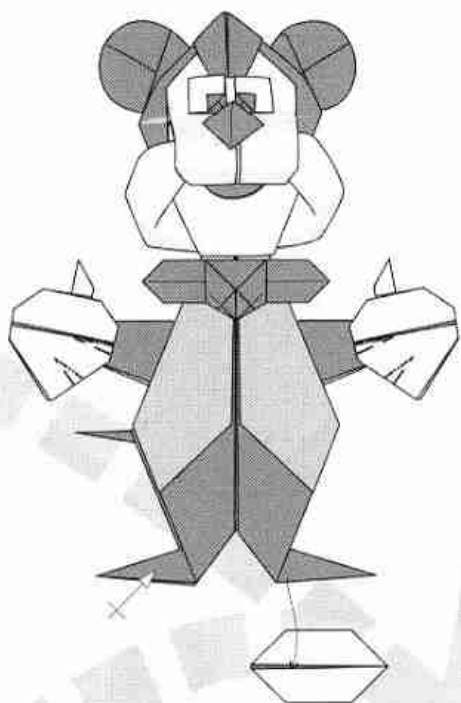
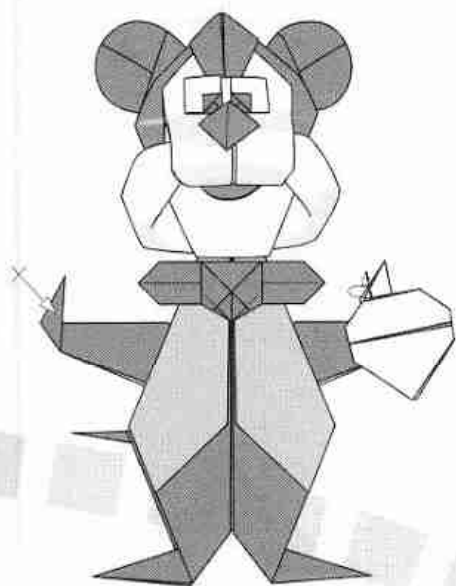

Página (Desarr.)	Pieza nº	Cantidad	Porción	COLORES		Tamaño original	Tamaño 3/10	Tamaño 2/5	Tamaño 3/5
				Anverso	Reverso	12 cm alto	3,6 cm alto	5 cm alto	7 cm alto
						Lado (cm) =	Lado (cm) =	Lado (cm) =	Lado (cm) =
51	1	1	Cara	Negro	Naranja	15	4,5	6	9
52	2	1	Cuerpo	Negro	Naranja	20	6	8	12
52	3	4	Miembros	Neutro	Naranja	10	3	4	6
54	4	1	Lengua	Neutro	Rojo	5	1,5	2	3
56	5	1	Orejas	Neutro	Negro	7,5	2,25	3	4,5
56	6	2	Ojos	Negro	Negro	-	-	-	-

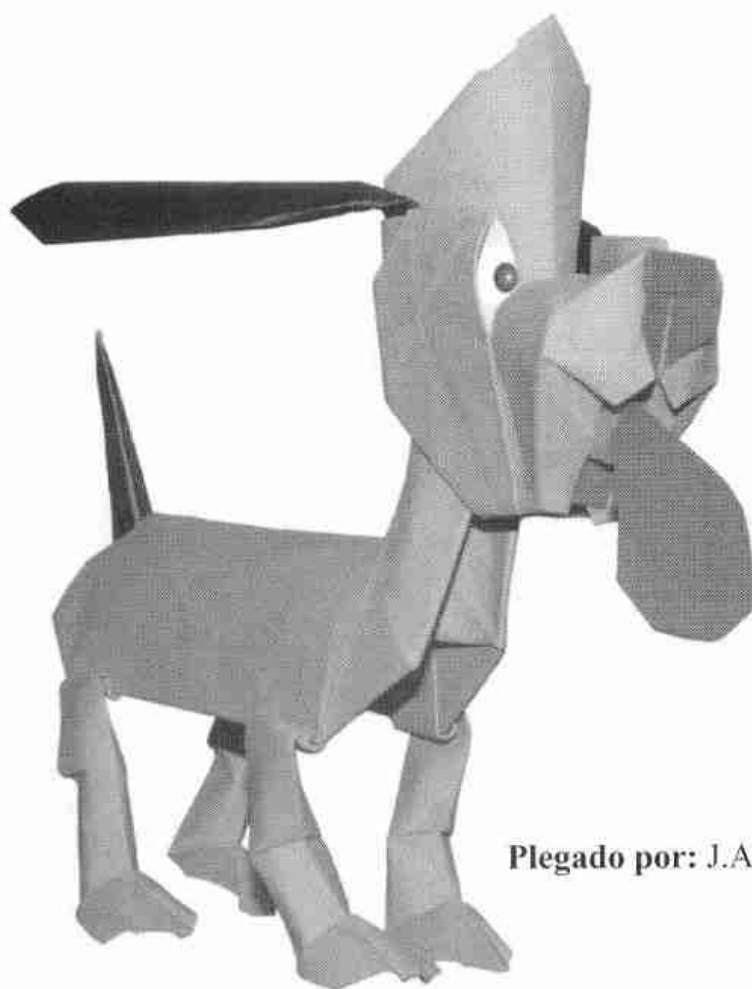

Plegado por: J.A.V.I.

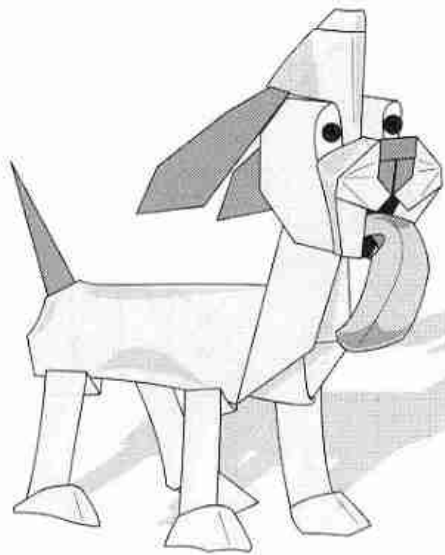

Utilizando las medidas recomendadas, se obtiene un modelo final de 12 cms.

Autor:	Halle
Nivel de dificultad:	Medio
Número de piezas:	10
Forma de las piezas:	Cuadrados

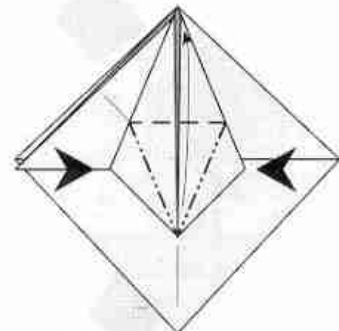
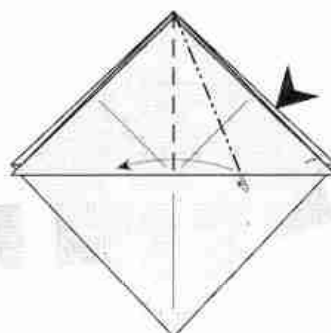
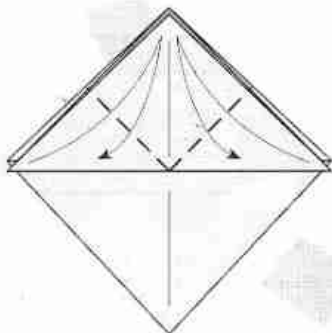
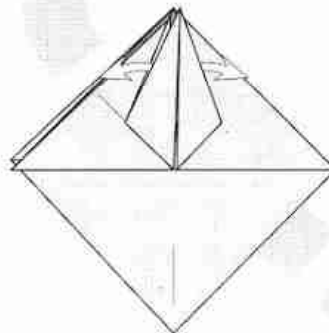
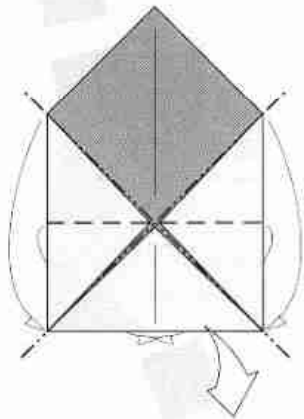
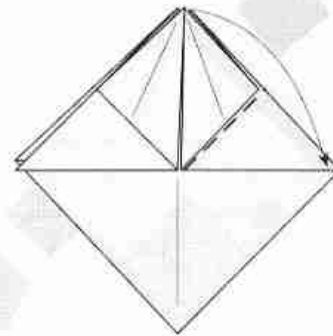
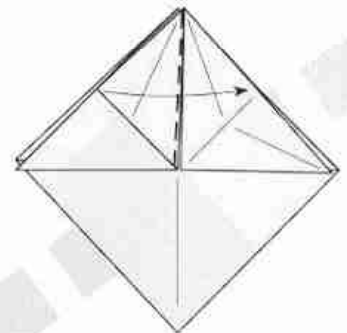
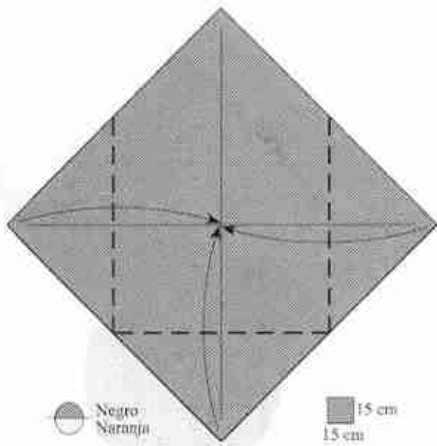

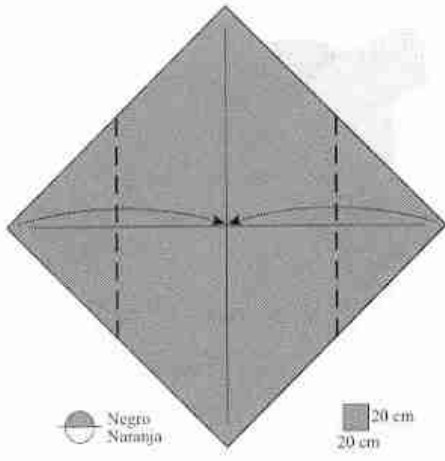
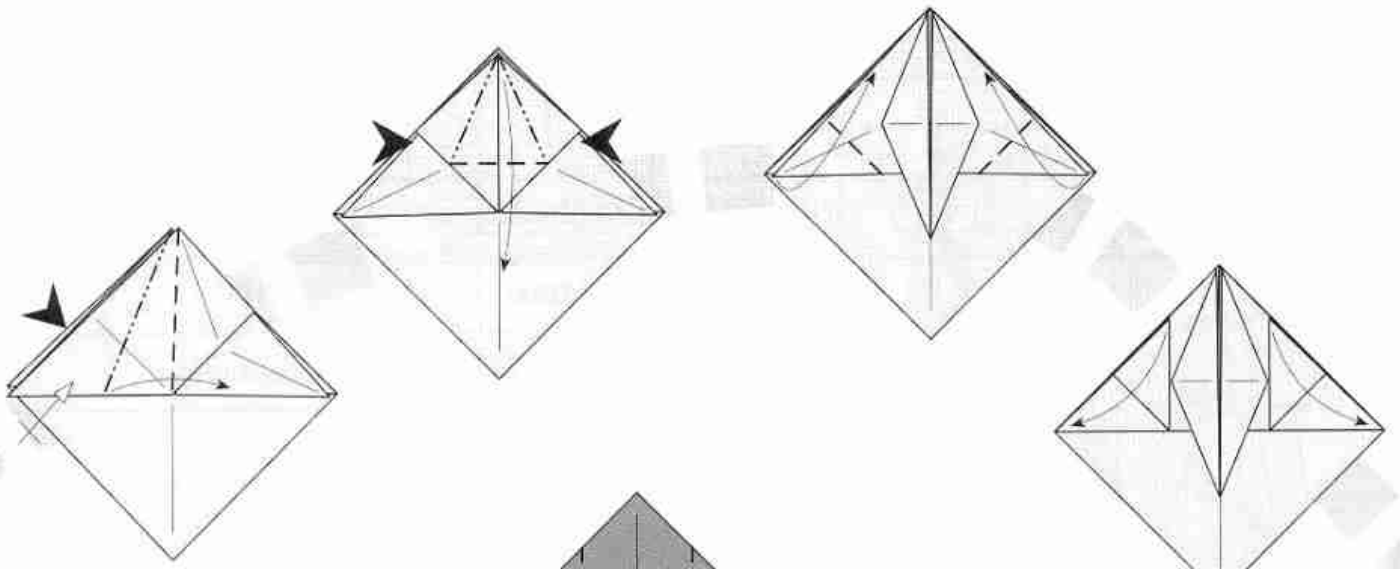

● Negro
○ Naranja

■ 20 cm
□ 20 cm

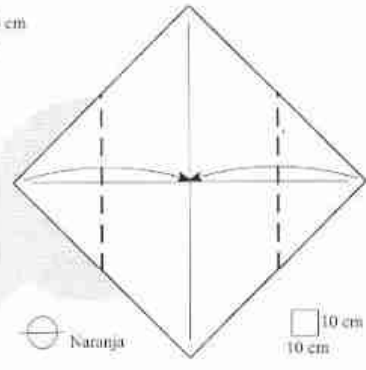
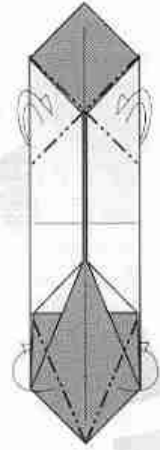
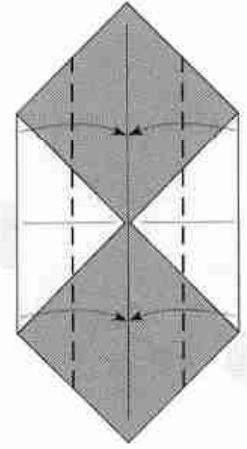

○ Naranja

□ 10 cm
□ 10 cm

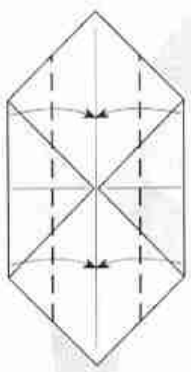

90°

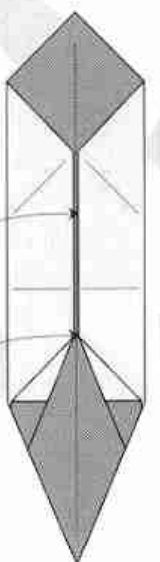
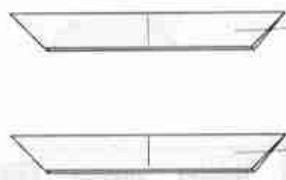

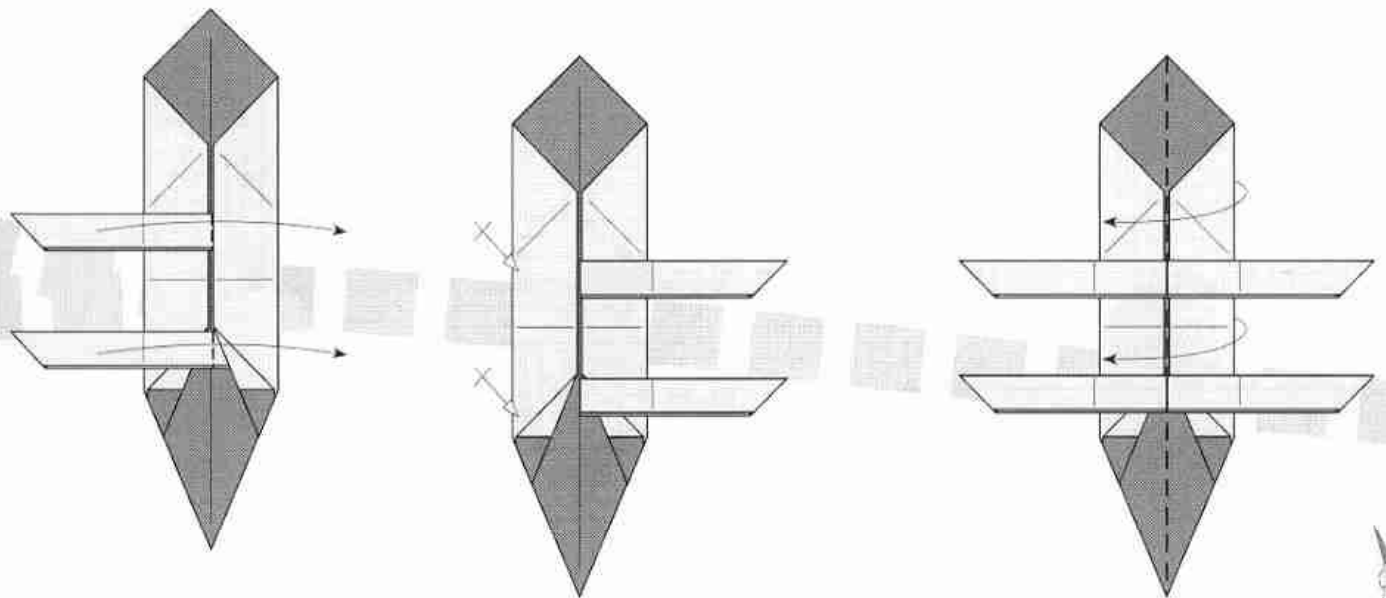
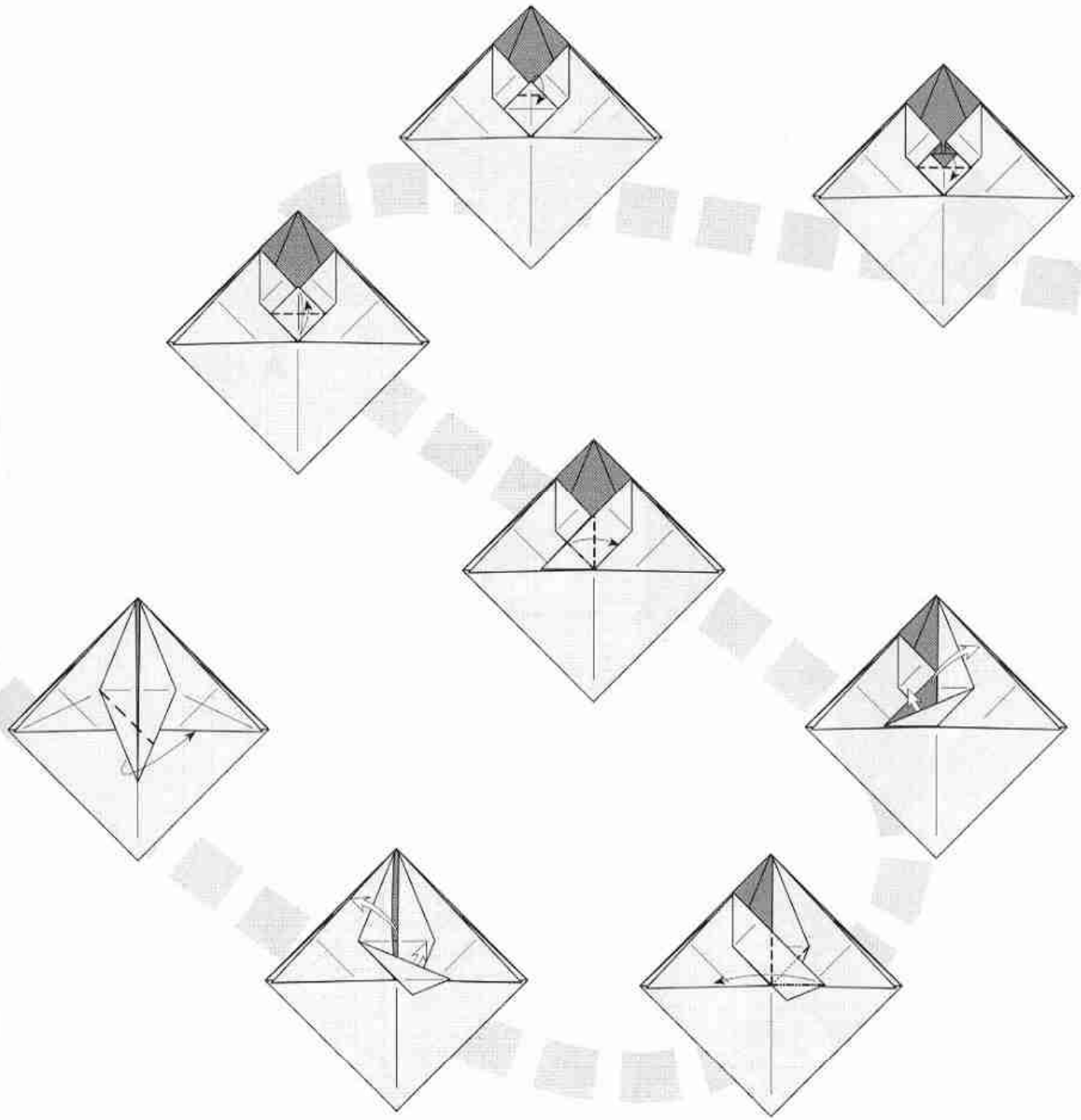

180°

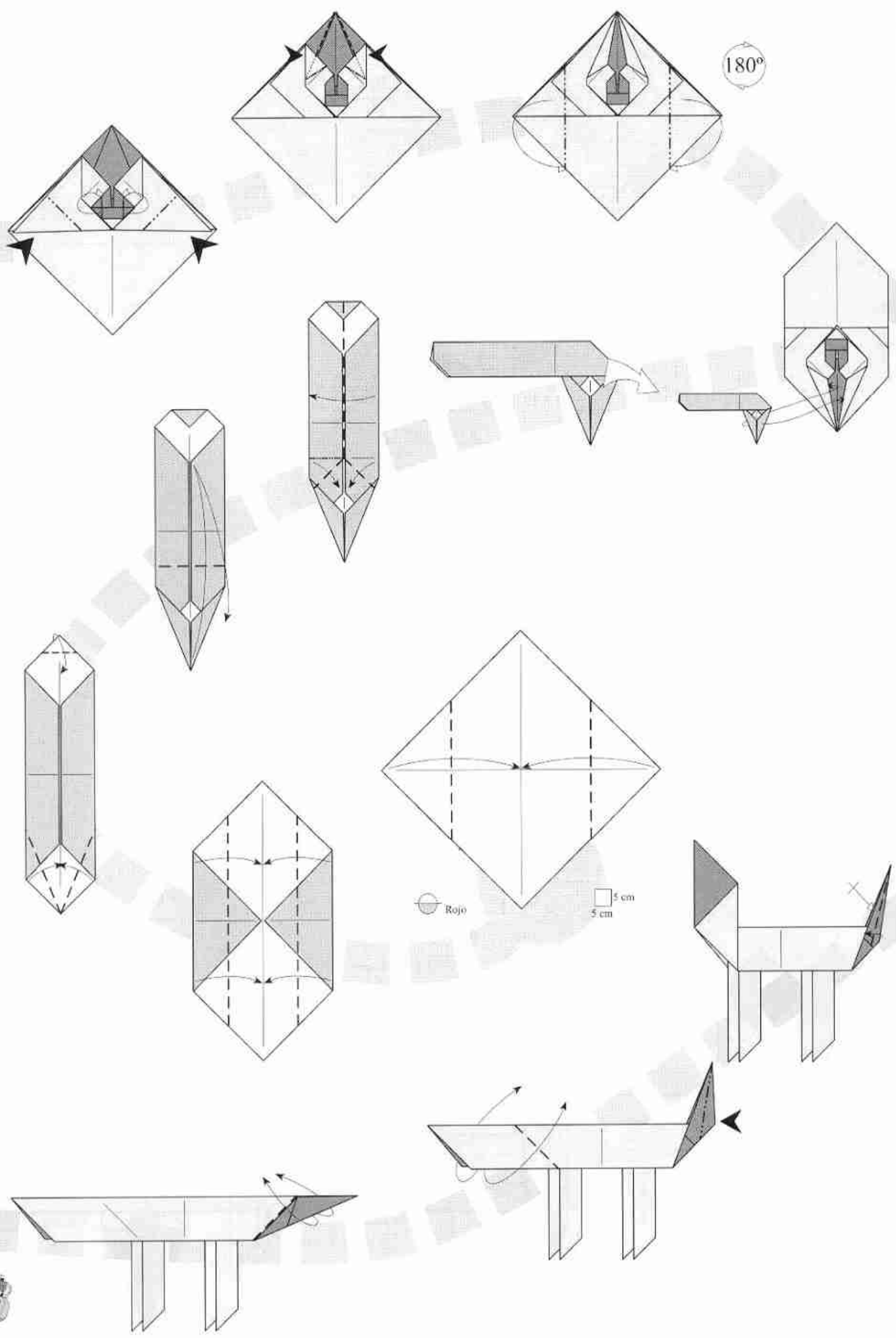

Rojo

5 cm
5 cm



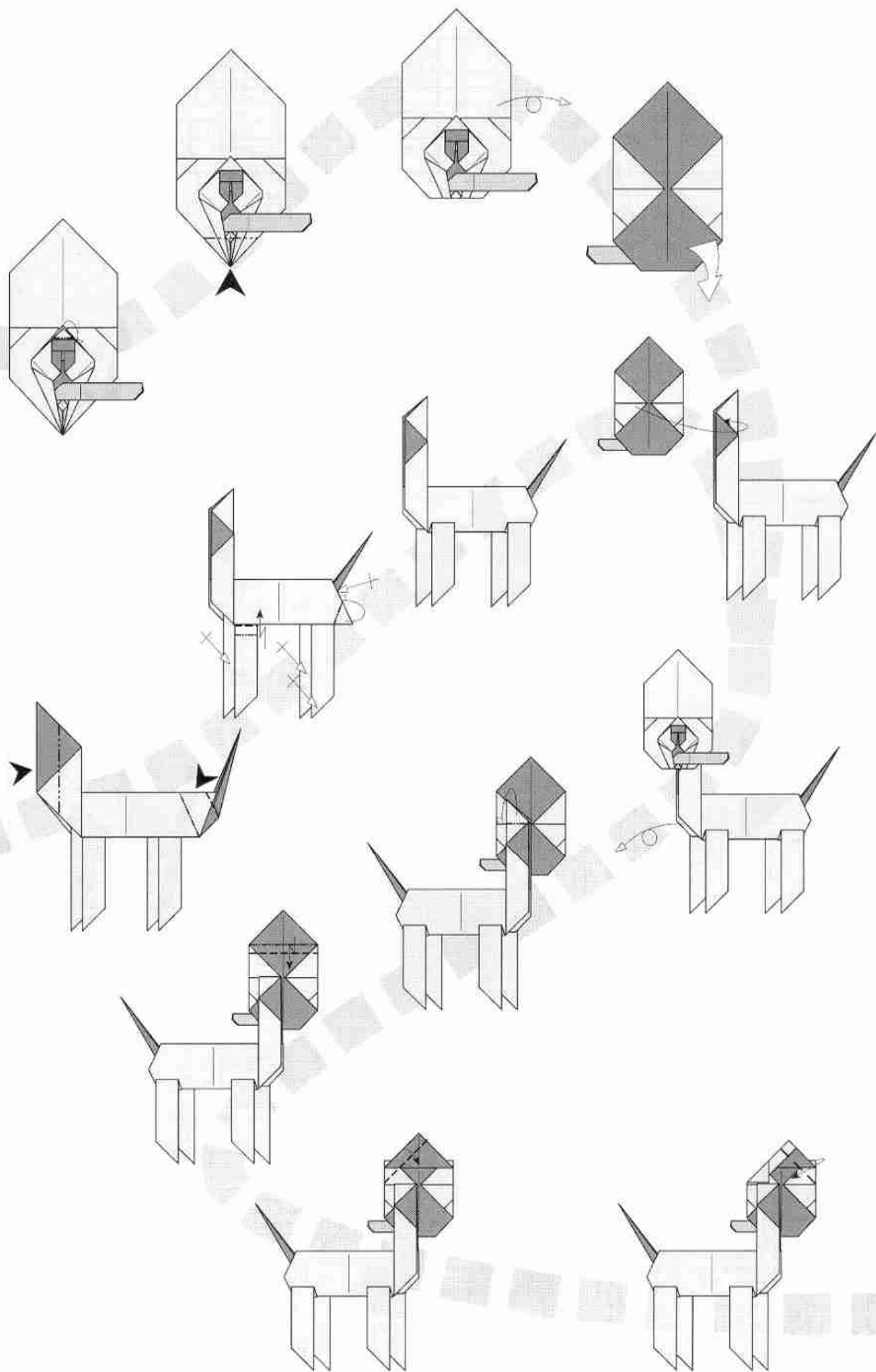

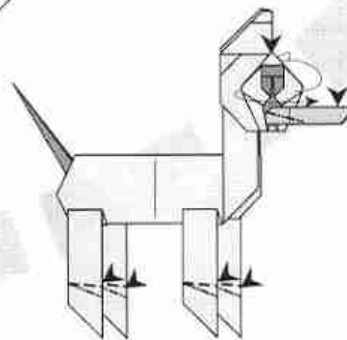
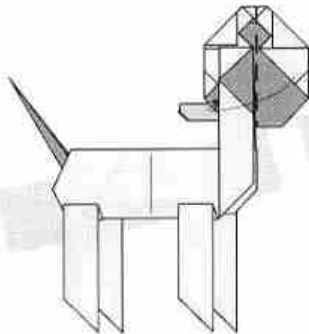
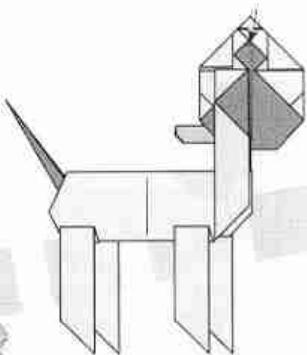
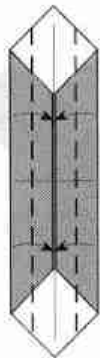
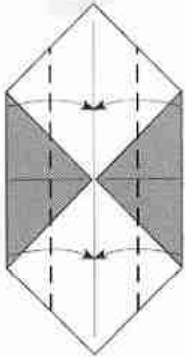
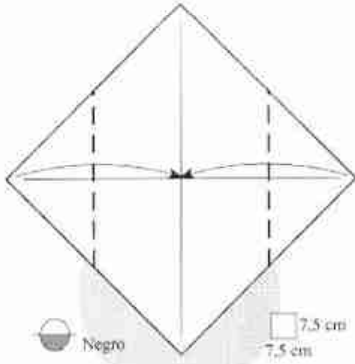
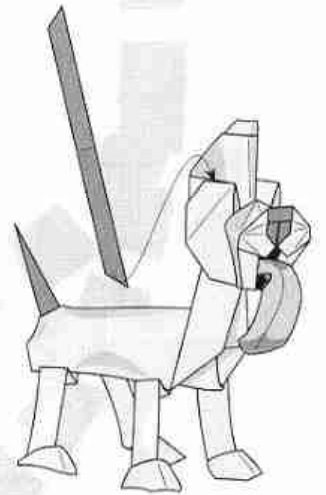
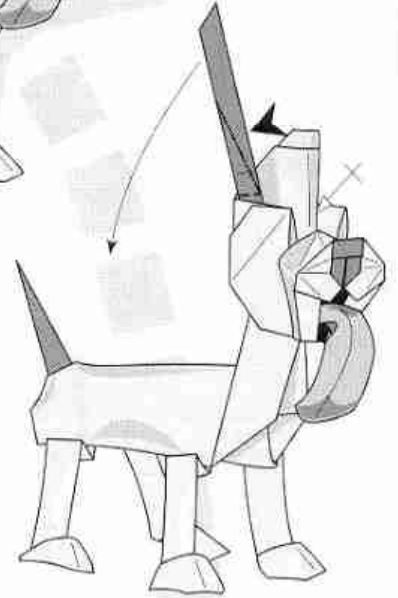
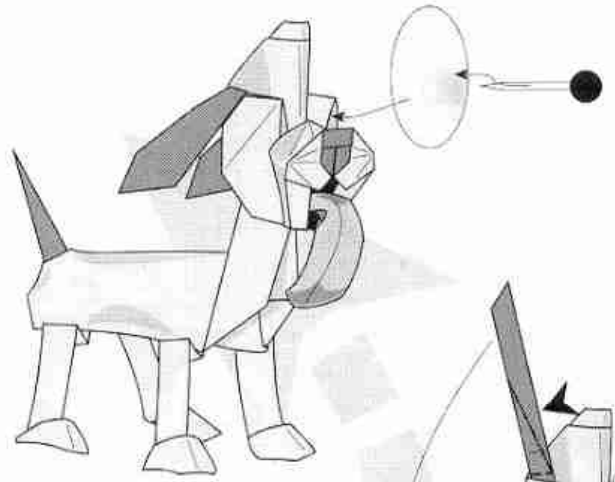
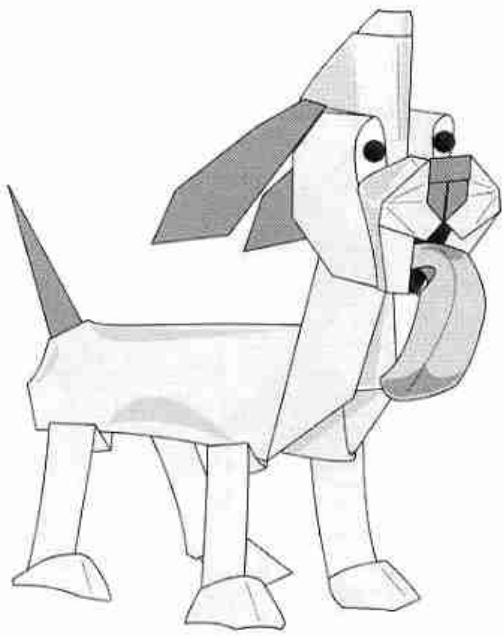

Página (Desarr.)	Pieza nº	Cantidad	Porción	COLORES		Tamaño original	Tamaño 3/10	Tamaño 2/5	Tamaño 3/5
				Anverso	Reverso	18 cm alto	5,4 cm alto	7,2 cm alto	10,8 cm alto
						Lado (cm) =	Lado (cm) =	Lado (cm) =	Lado (cm) =
58	1	1	Cara boca	Naranja	Blanco	20	6	8	12
59	2	1	Cara ojos	Negro	Blanco	20	6	8	12
59	3	1	Cuerpo	Blanco	Azul	20	6	8	12
60	4	1	Lazo	Neutro	Rojo	7,5	2,25	3	4,5
61	5	1	Brazos	Blanco	Azul	15	4,5	6	9
63	6	2	Piernas	Neutro	Naranja	10	3	4	6
64	7	1	Gorro	Negro	Azul	15	4,5	6	9

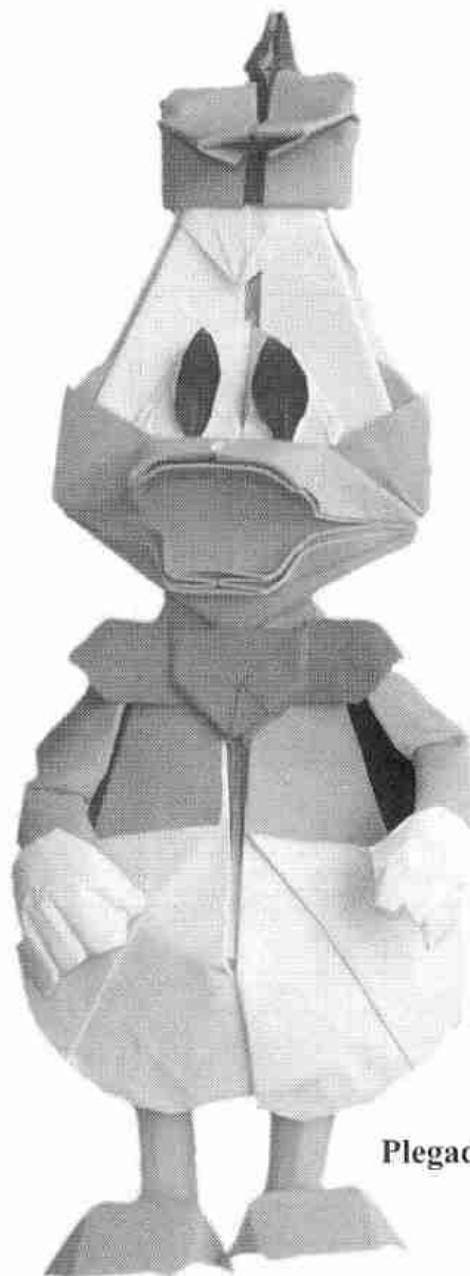

Plegado por: J.A.V.I.



Utilizando las medidas recomendadas, se obtiene un modelo final de 18 cms.

Autor:	Halle
Nivel de dificultad:	Medio-Alto
Número de piezas:	8
Forma de las piezas:	Cuadrados

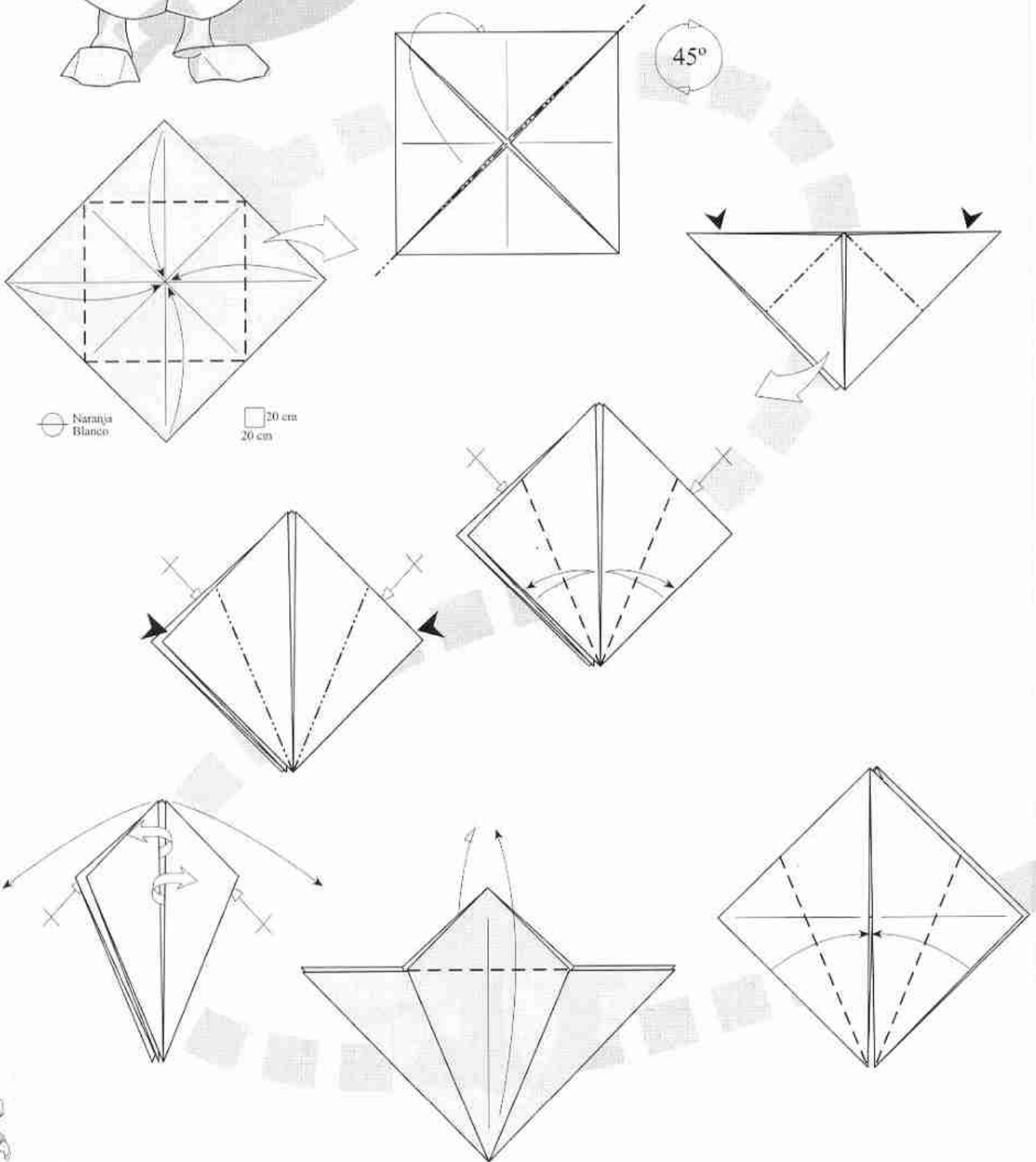

○ Naranja
○ Blanco

□ 20 cm
□ 20 cm



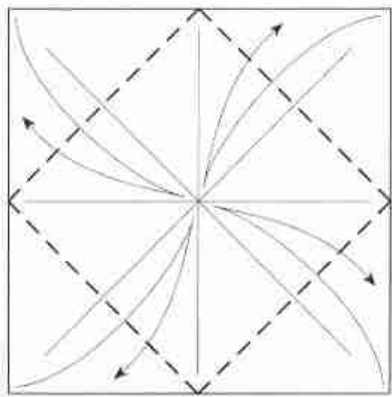

Blanco
Azul

20 cm
20 cm

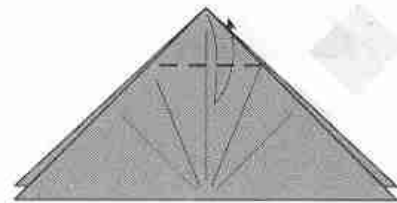
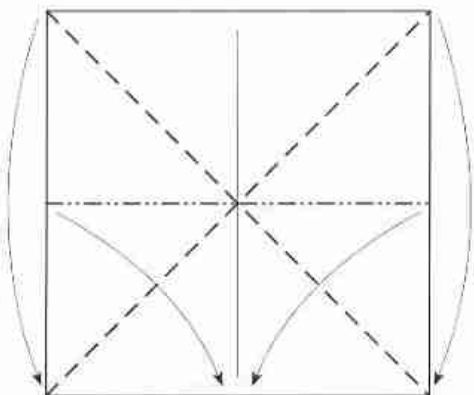
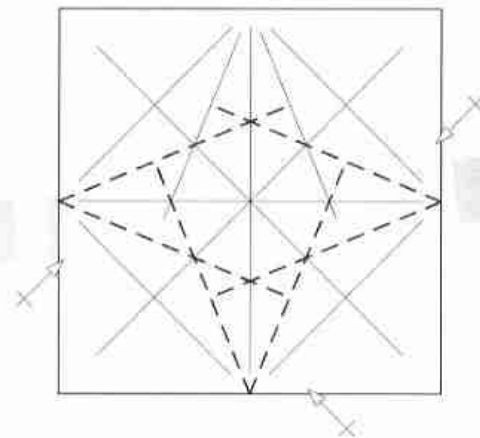
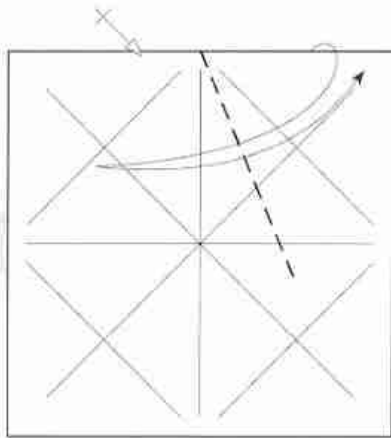

Blanco
Negro

20 cm
20 cm

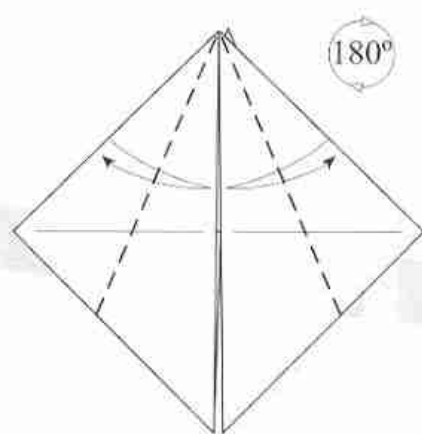
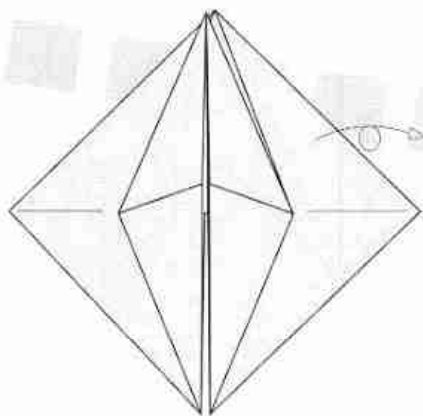
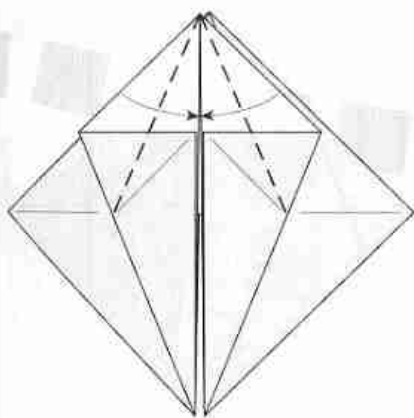
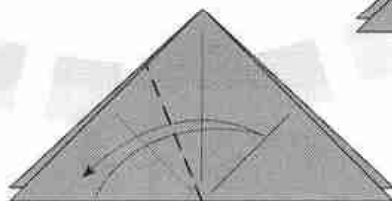
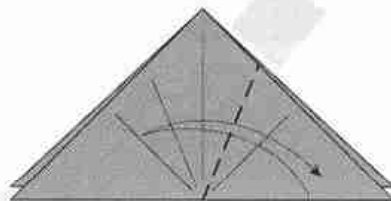
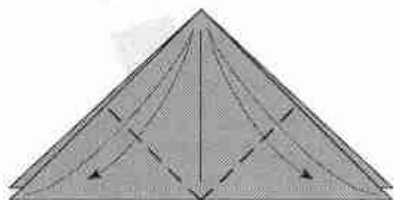

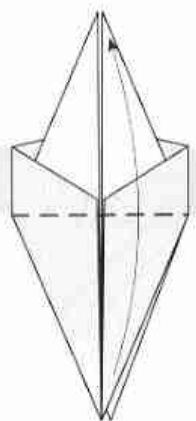
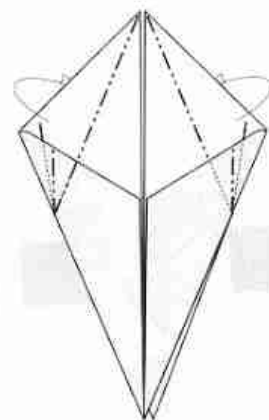
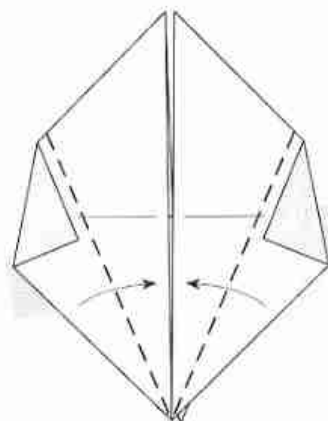
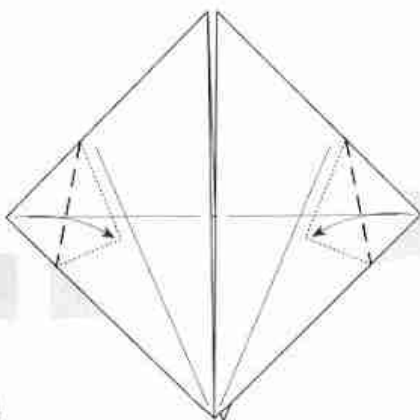
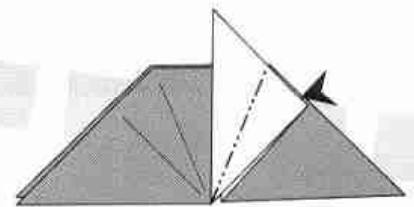
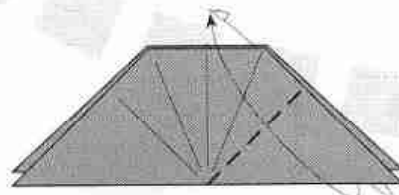
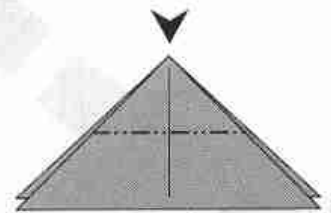
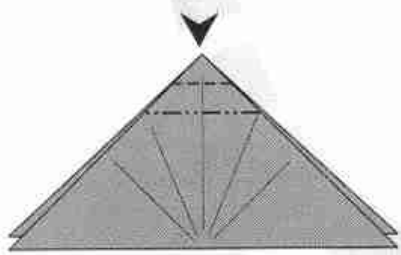
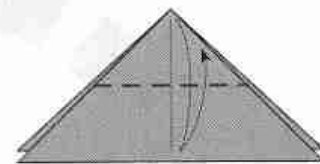
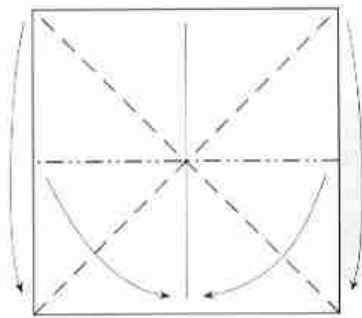
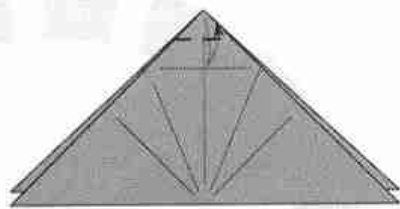
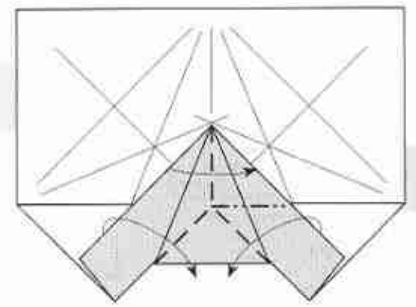
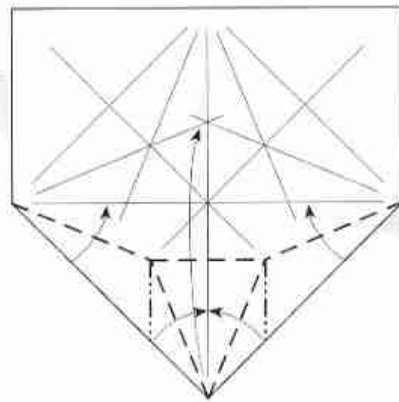
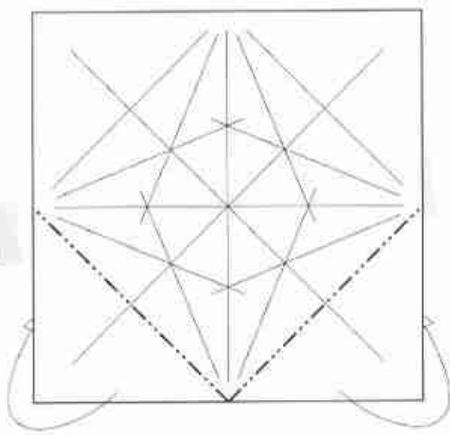

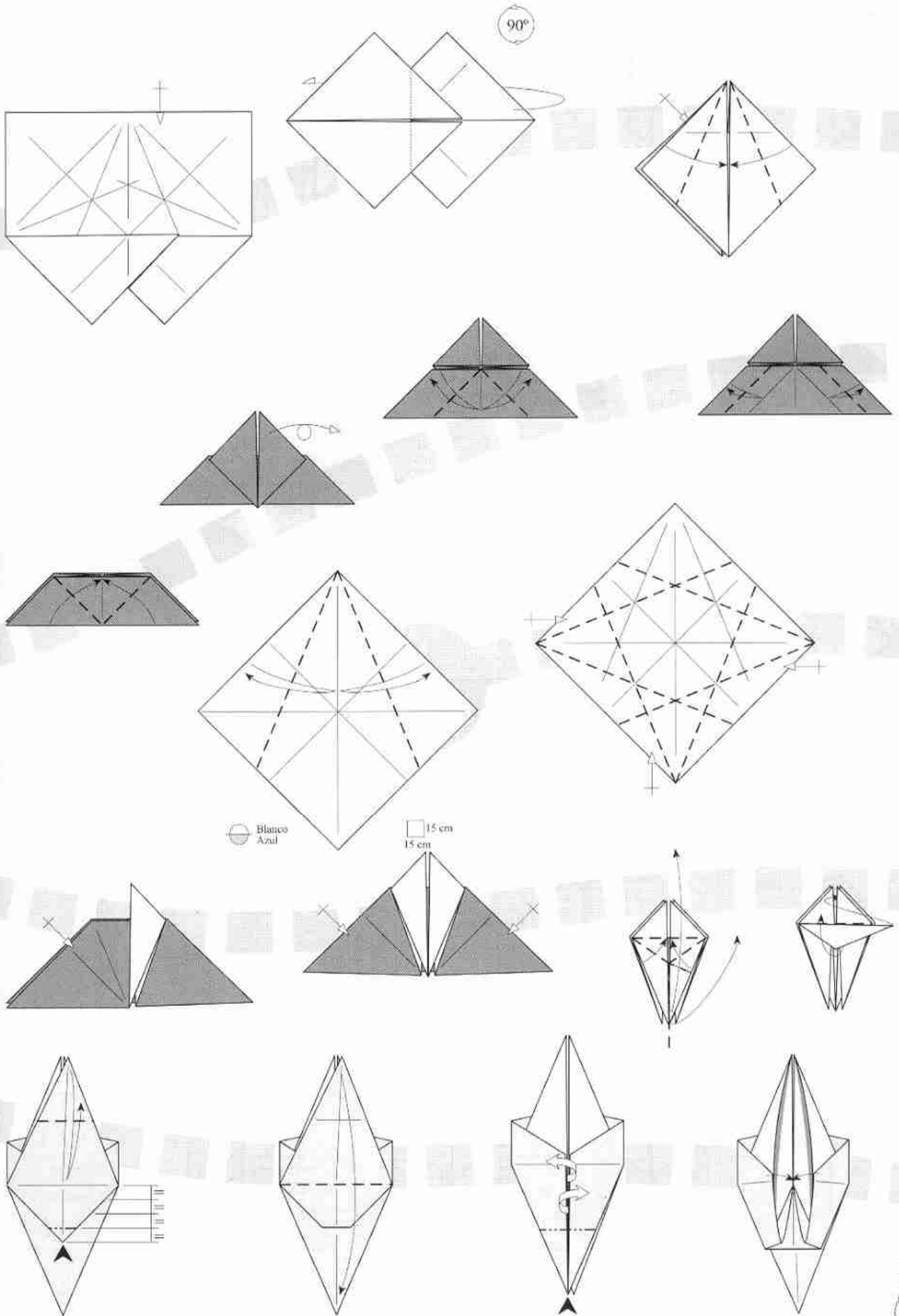

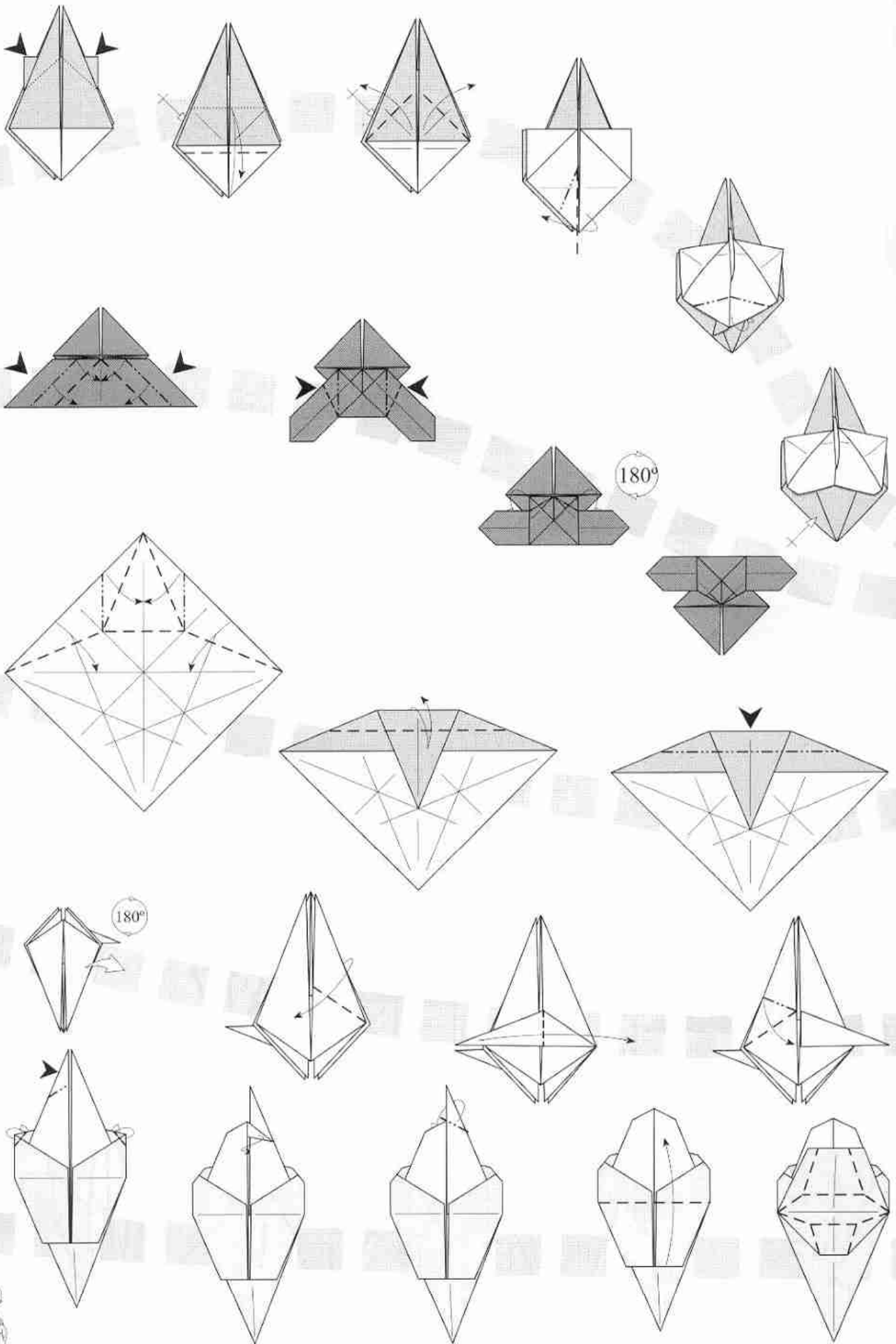

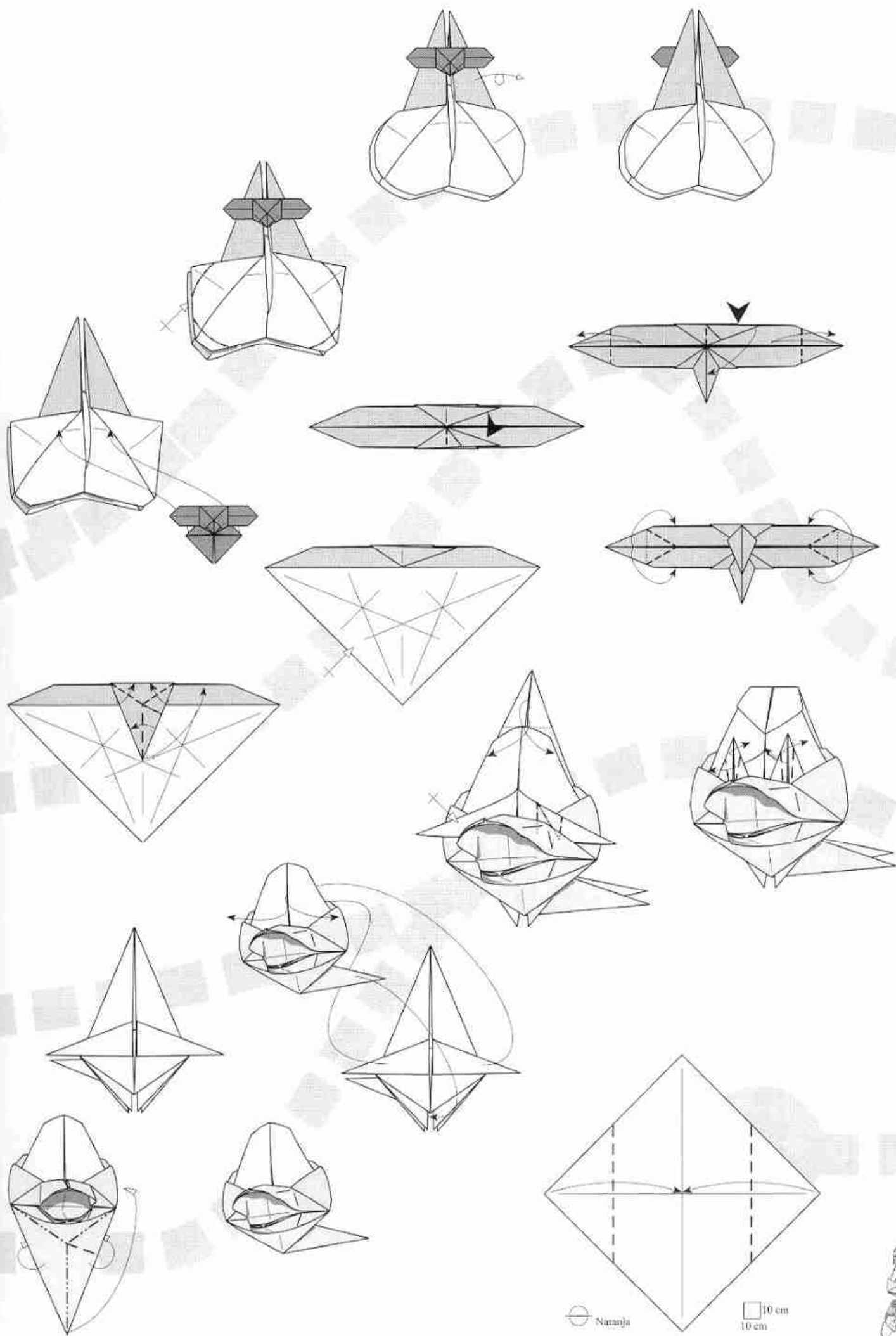

○ Naranja

□ 10 cm
10 cm



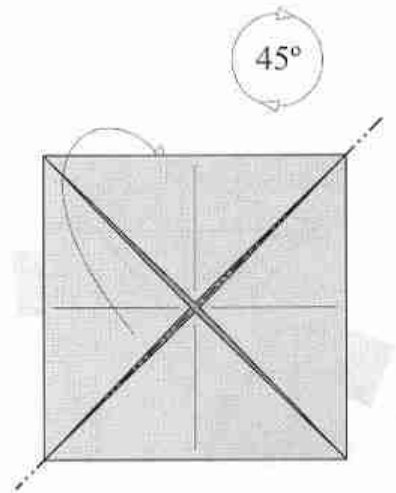
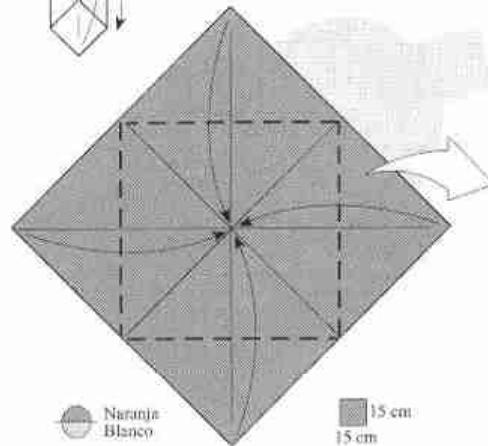
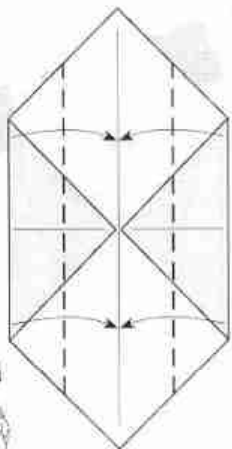
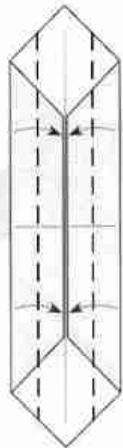
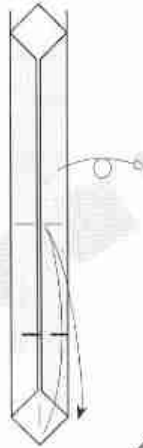
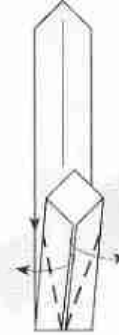
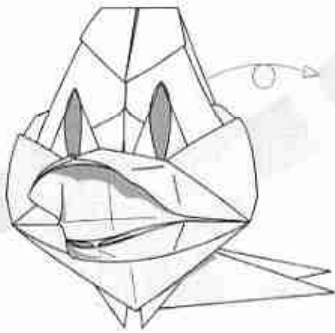
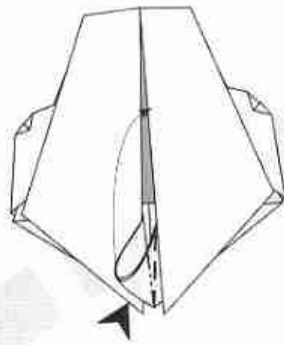
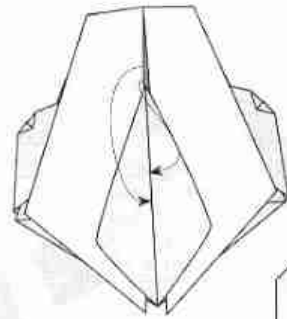
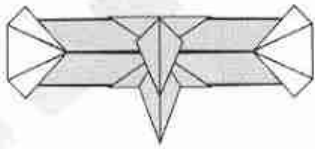
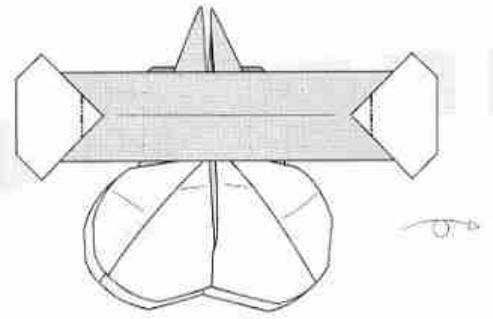
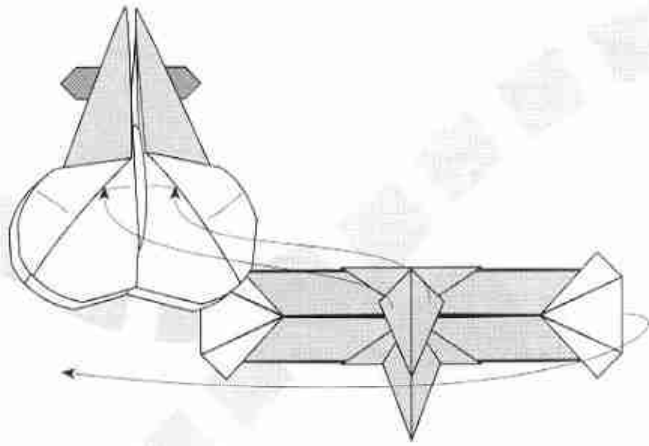

● Naranja
● Blanco

■ 15 cm
■ 15 cm



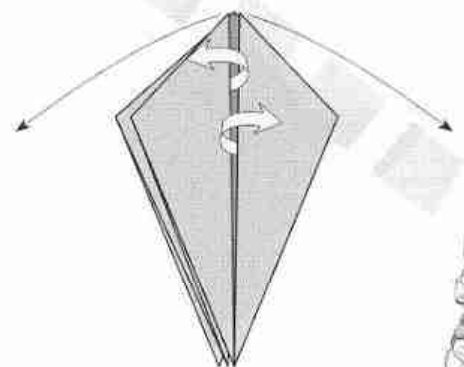
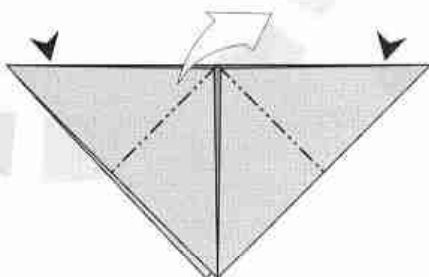
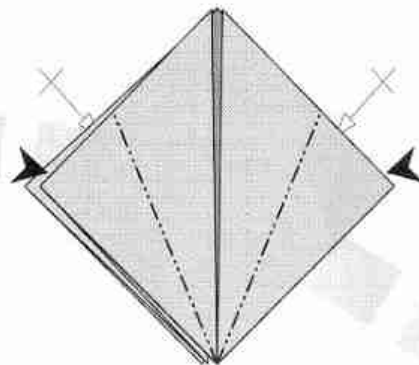
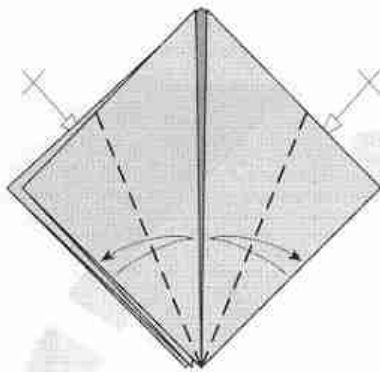
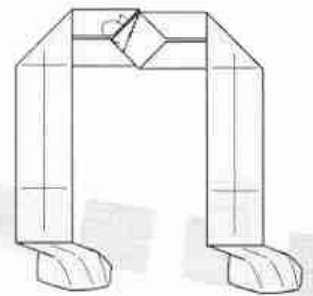
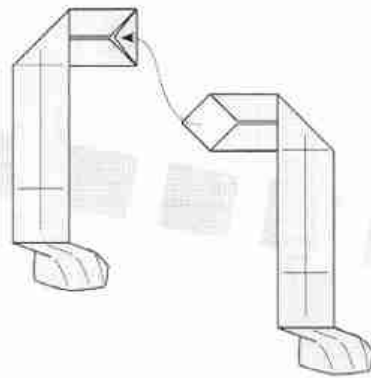
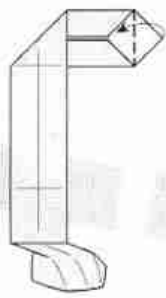
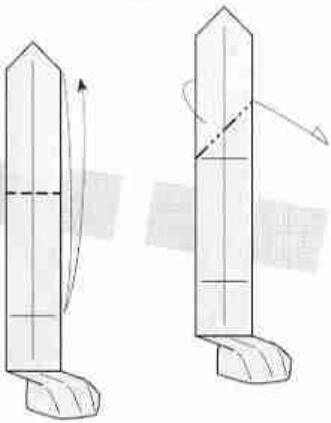
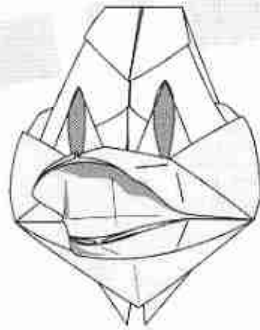
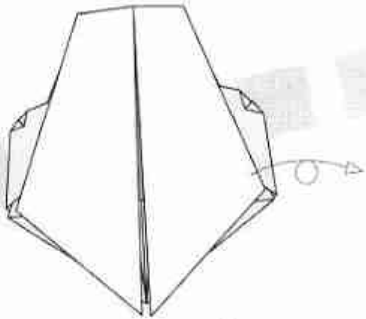
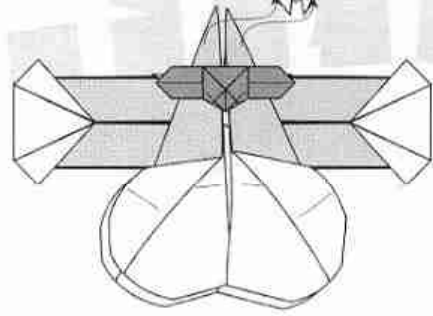
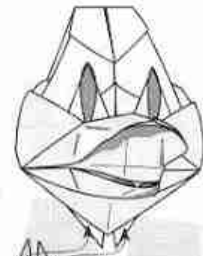
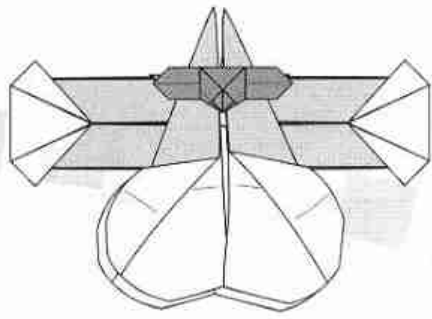

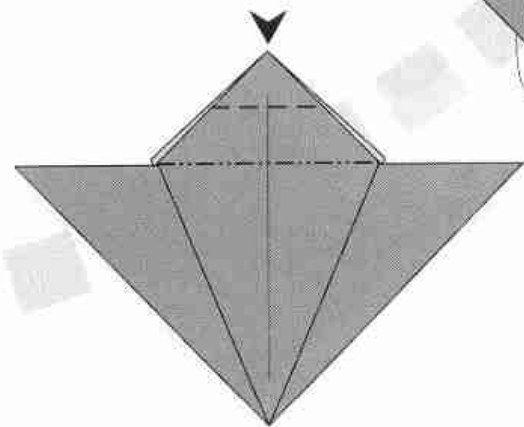
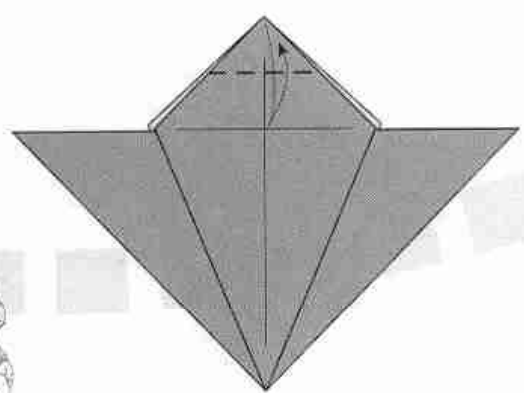
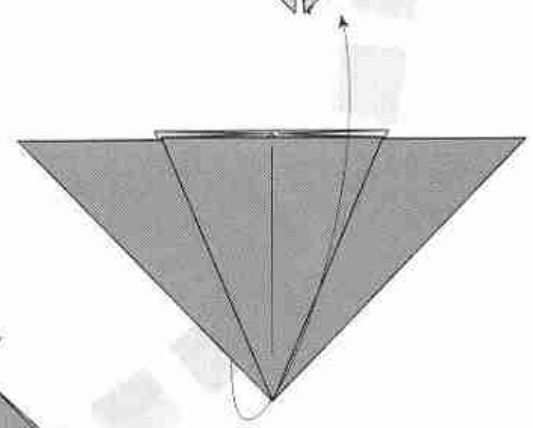
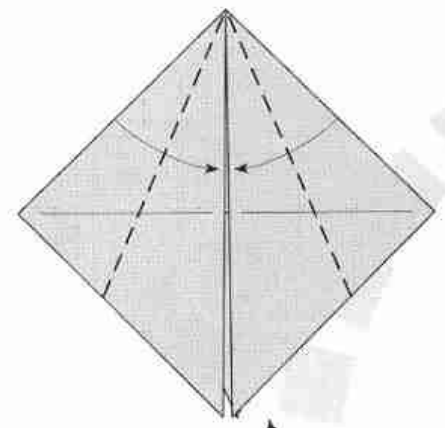
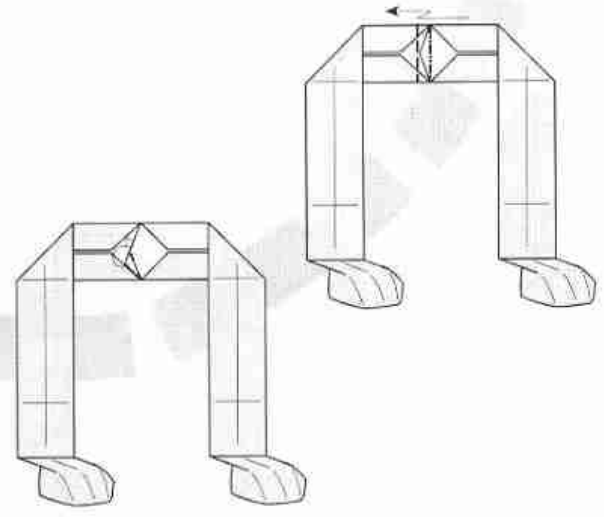
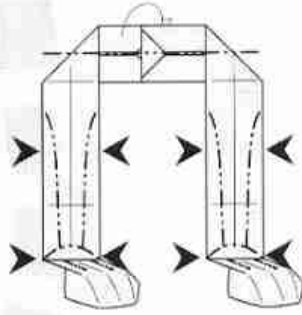
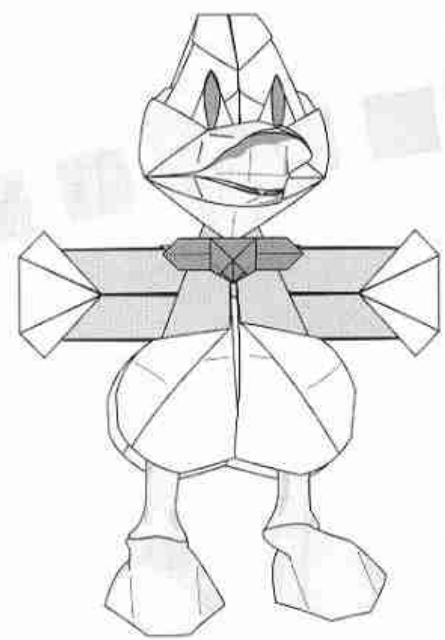
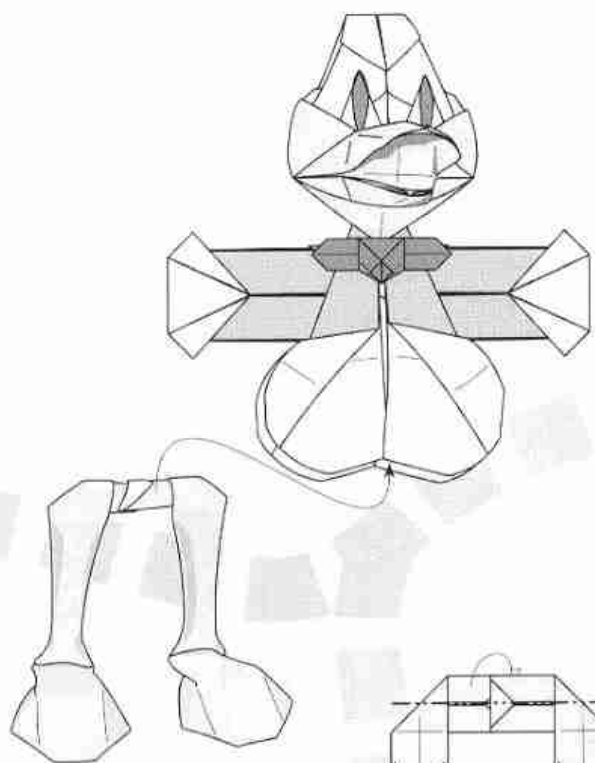

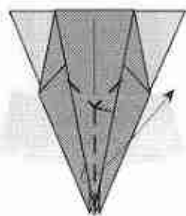
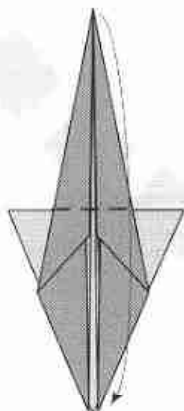
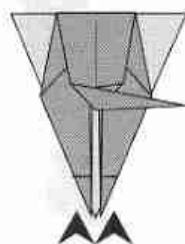
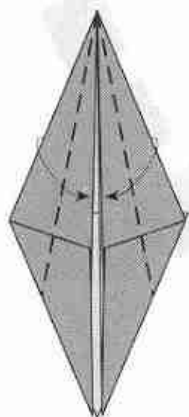
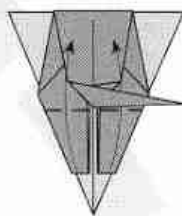
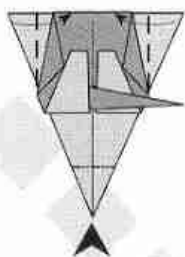
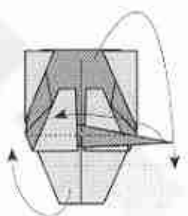
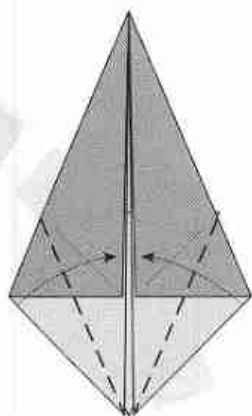
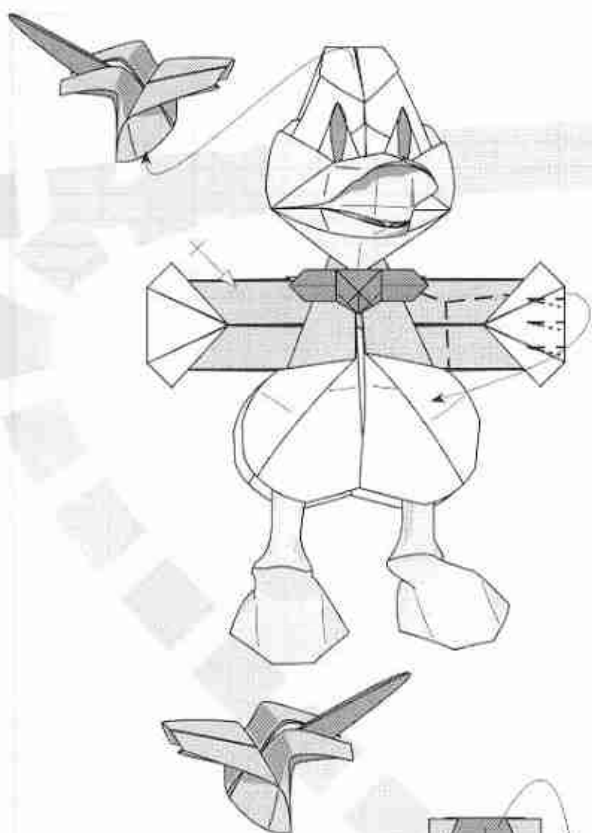

Página (Desarr.)	Pieza nº	Cantidad	Porción	COLORES		Tamaño original	Tamaño 3/10	Tamaño 2/5	Tamaño 3/5
				Anverso	Reverso	15 cm alto	4,5 cm alto	6 cm alto	9 cm alto
						Lado (cm) =	Lado (cm) =	Lado (cm) =	Lado (cm) =
69	1	1	Base cuerpo	Azul	Amarillo	20	6	8	12
69	2	2	Brazos	Neutro	Amarillo	10	3	4	6
69	3	1	Camisa	Amarillo	Neutro	10	3	4	6
70	4	1	Ojos	Negro	Bianco	5	1,5	2	3
70	5	1	Boca	Marrón	Amarillo	10	3	4	6
71	6	1	Ventre	Azul	Azul	10	3	4	6
72	7	2	Piernas	Azul	Marrón	15	4,5	6	9

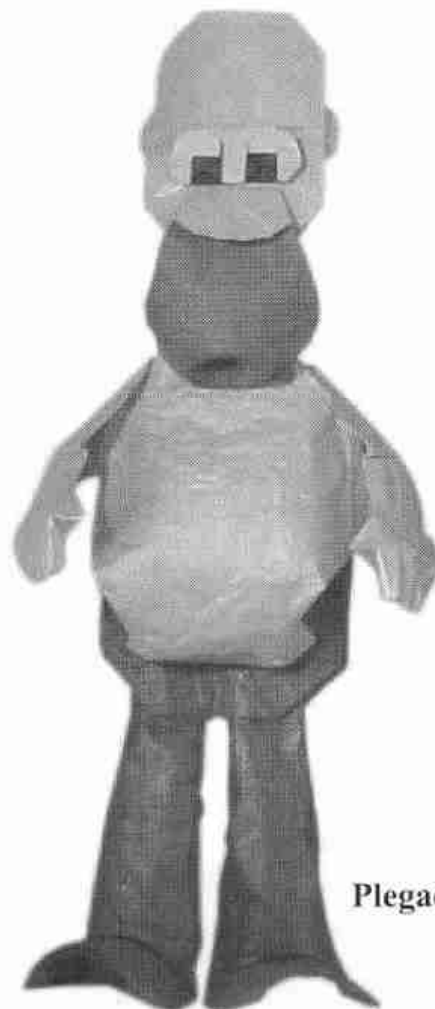

Plegado por: Nicolas Terry

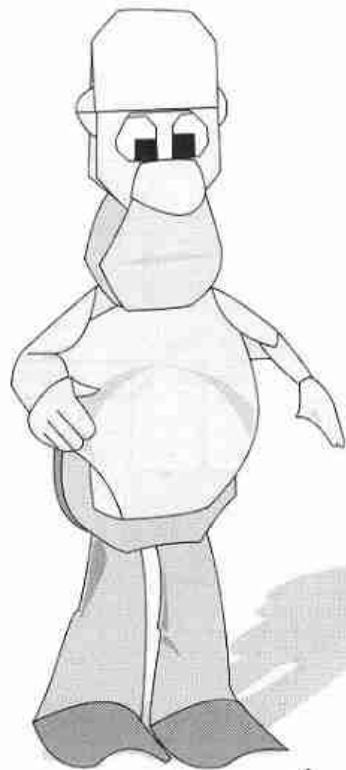

Utilizando las medidas recomendadas, se obtiene un modelo final de 15 cms.

Autor:	Halle
Nivel de dificultad:	Medio-Alto
Número de piezas:	10
Forma de las piezas:	Cuadrados

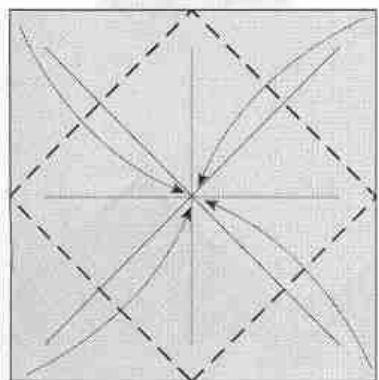
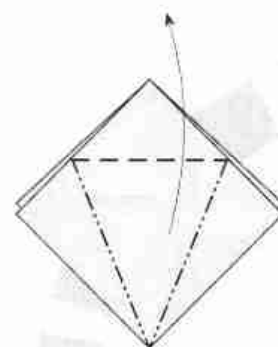
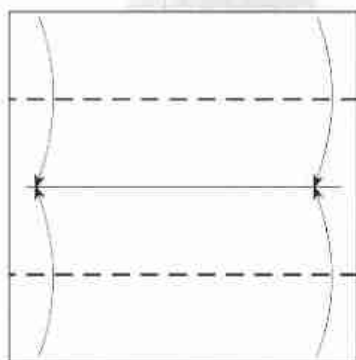
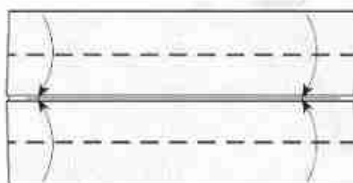
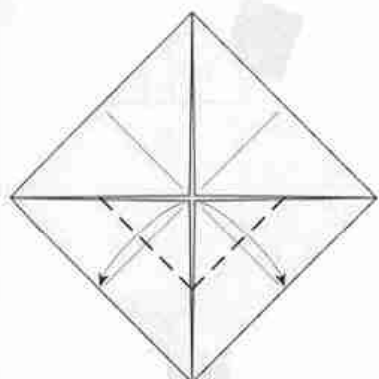
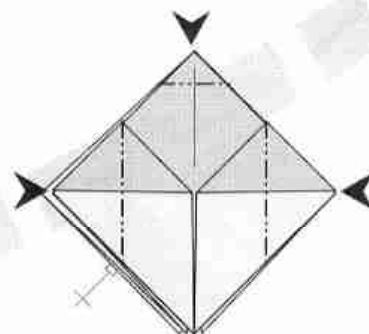
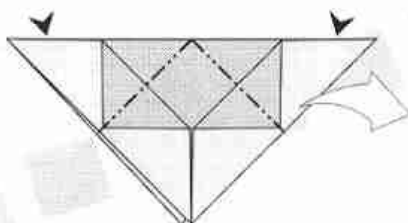
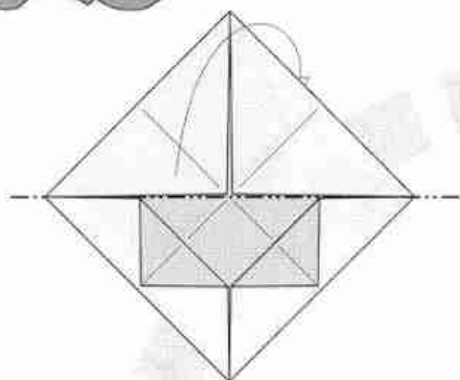

○ Amarillo

□ 10 cm
10 cm

○ Azul
○ Amarillo

□ 20 cm
20 cm

○ Amarillo

□ 10 cm
10 cm

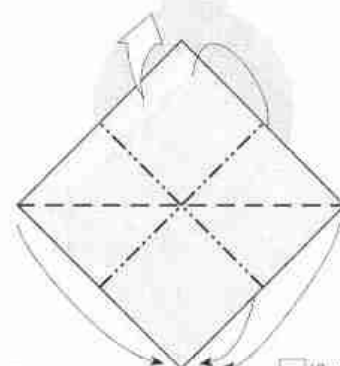

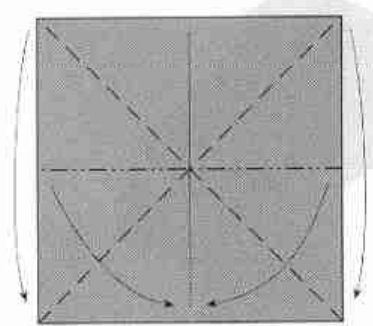
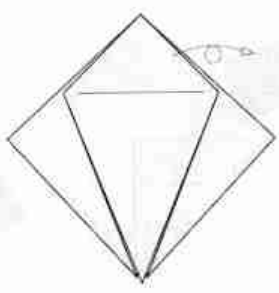
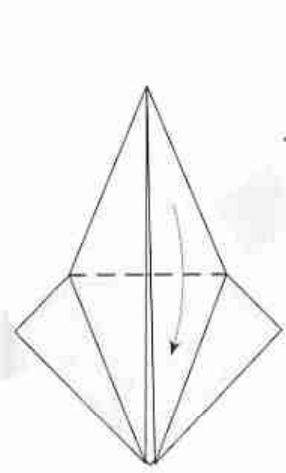
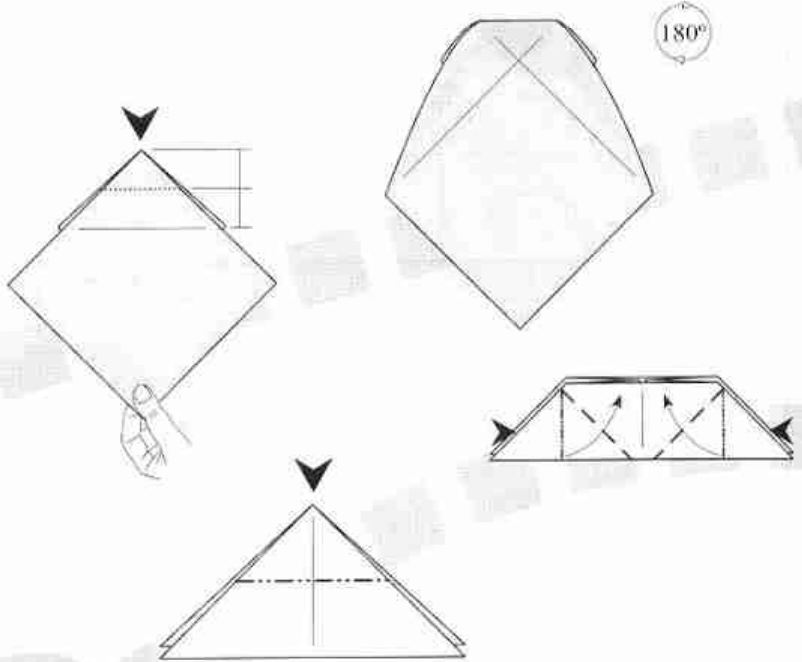
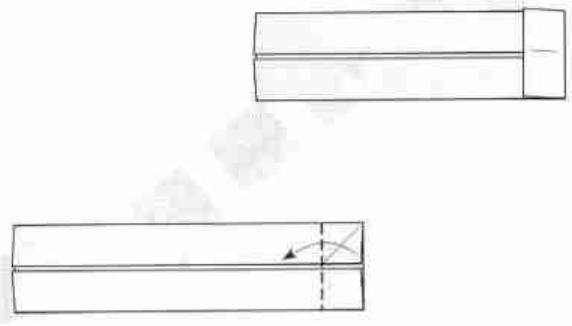
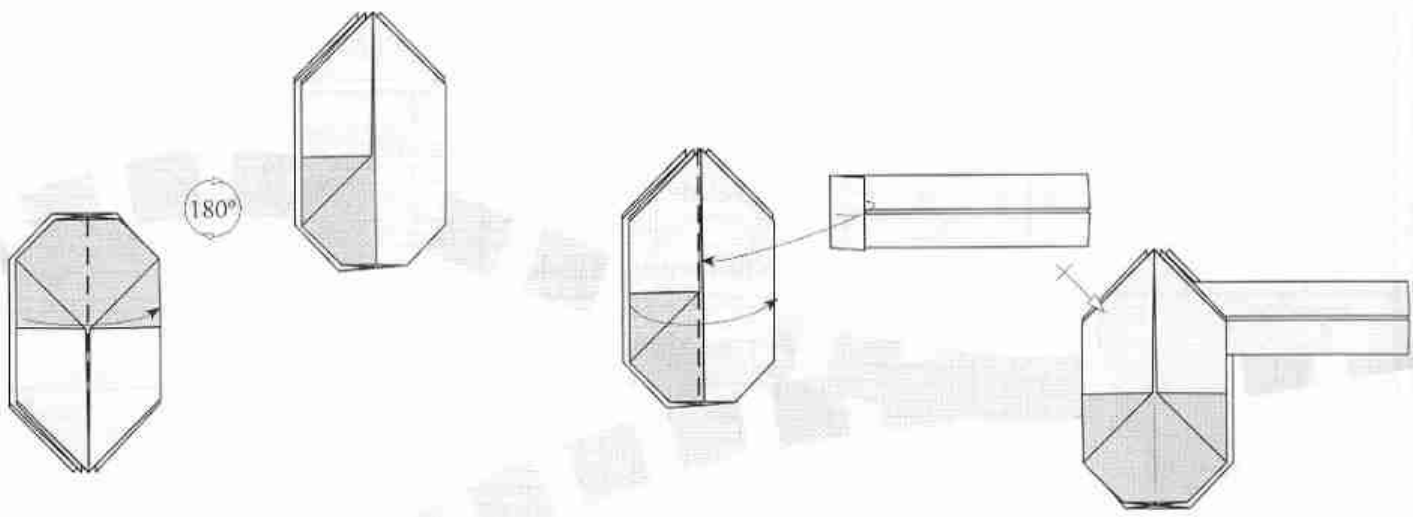

Negro
 Blanco
 5 cm
 5 cm

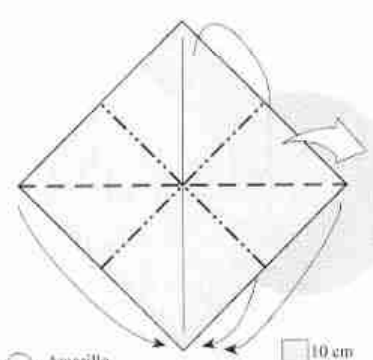

Amarillo
 Amarillo
 10 cm
 10 cm

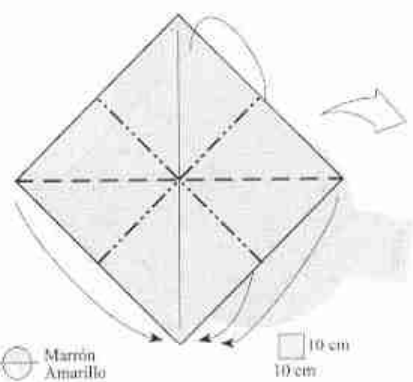

Marrón
 Amarillo
 10 cm
 10 cm

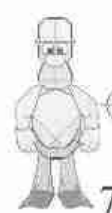
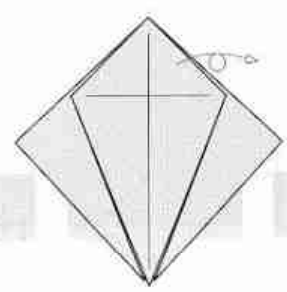
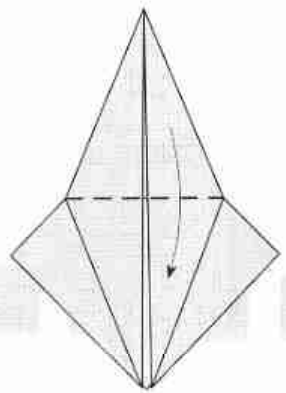
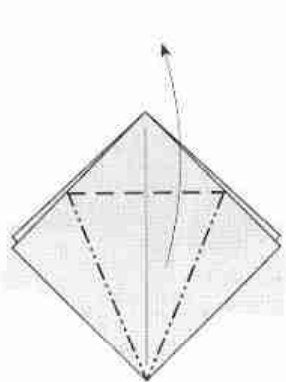

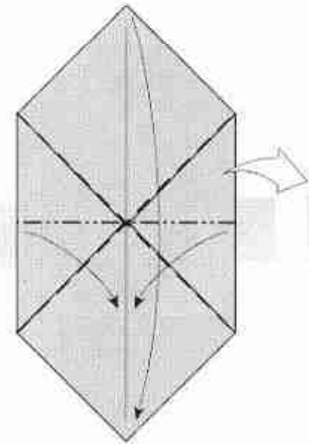
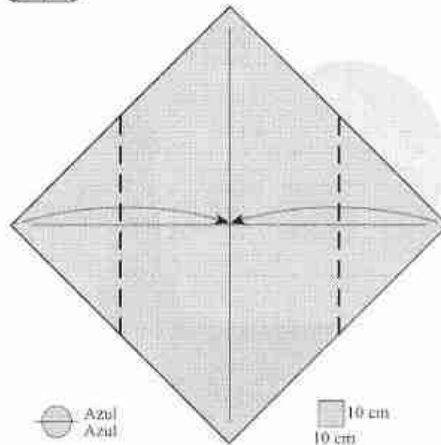
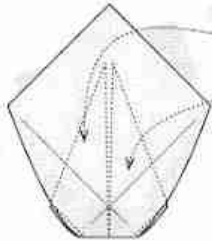
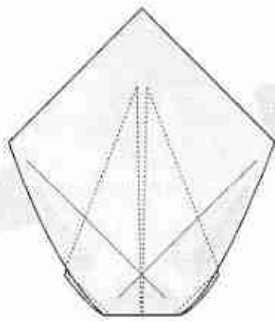
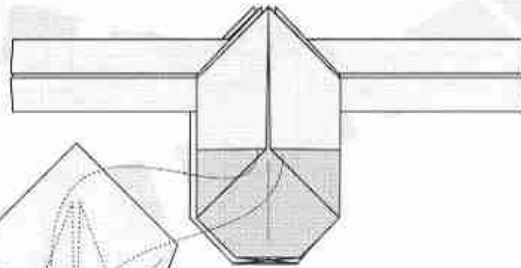
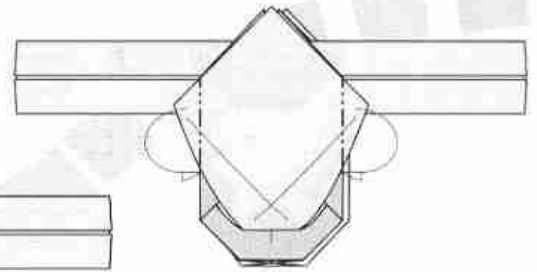
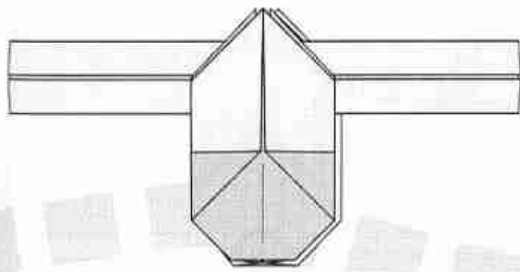

● Azul
● Azul

■ 10 cm
■ 10 cm

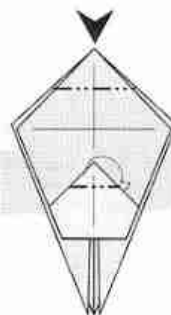
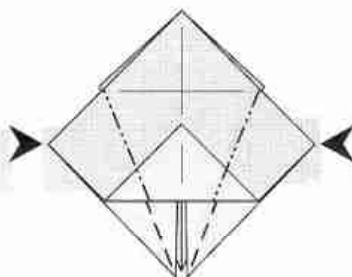
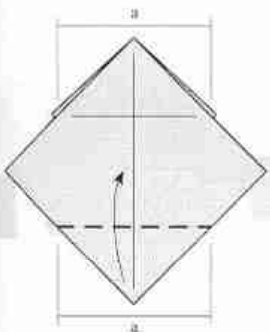
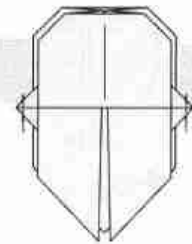
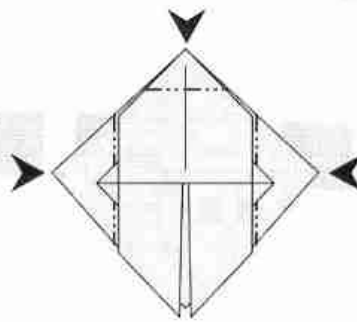
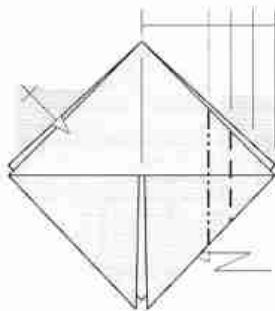
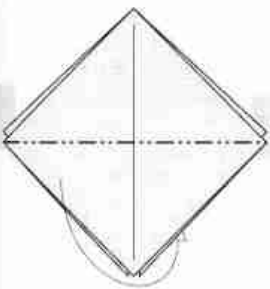
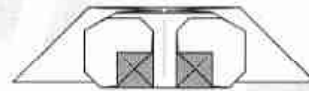
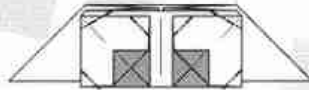

180°

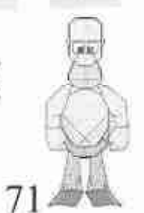
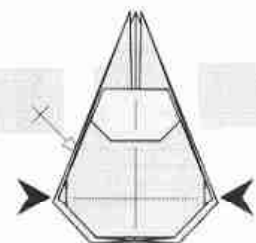

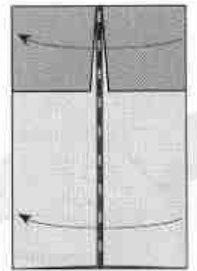
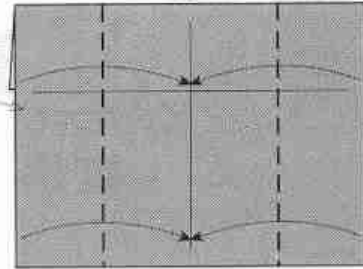
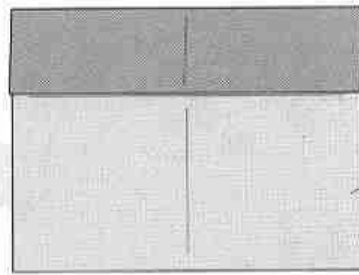
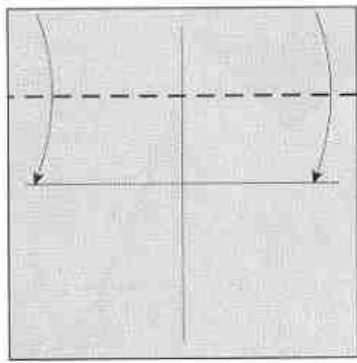
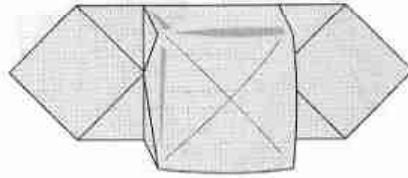
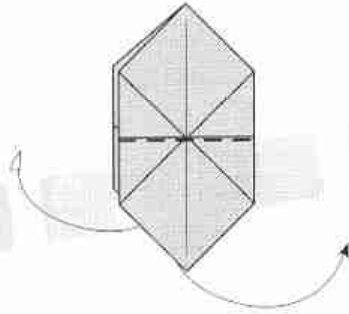
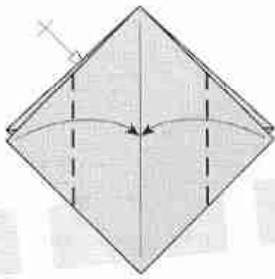
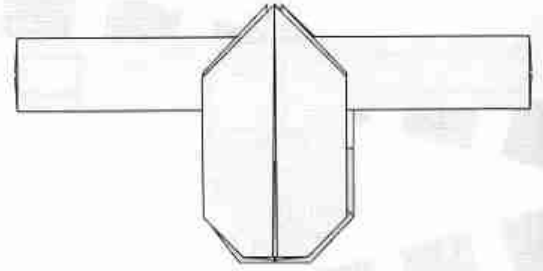
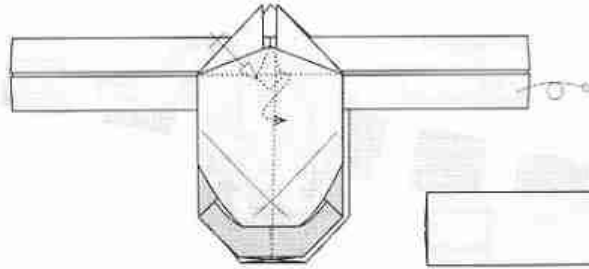
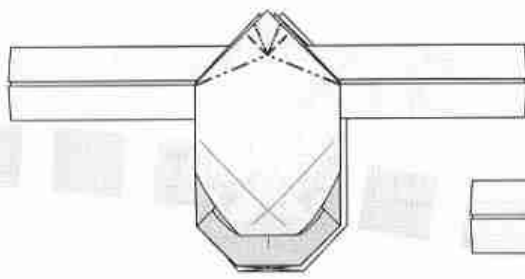

● Azul
● Marrón

■ 15 cm
■ 15 cm

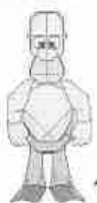
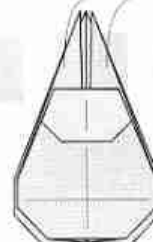
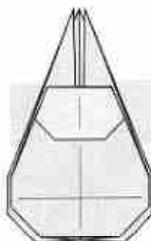
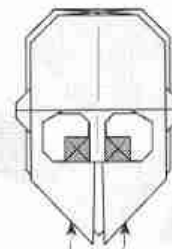
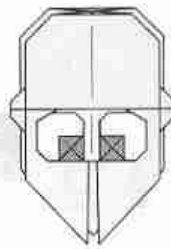
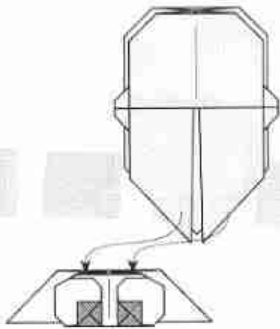

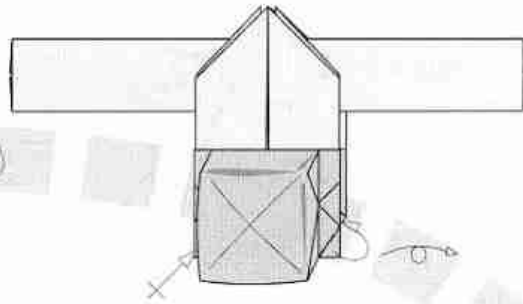
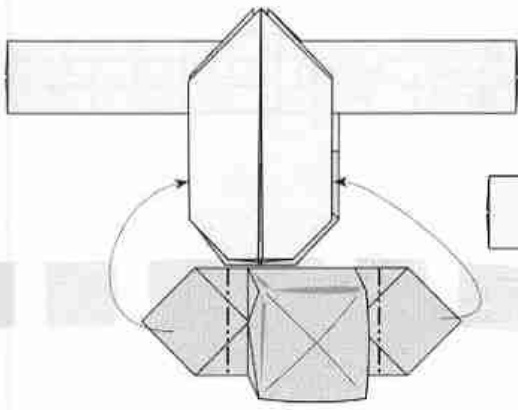

180°

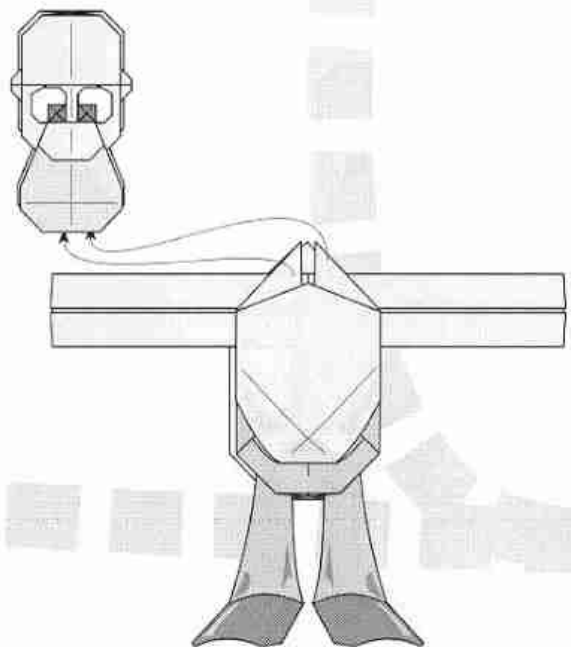
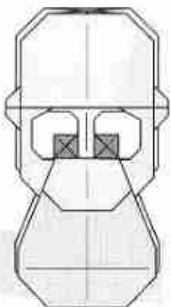
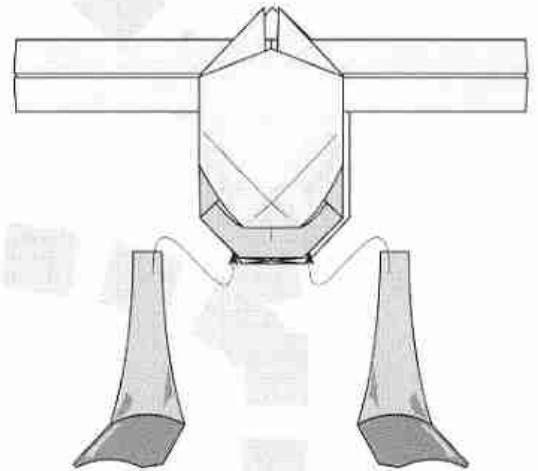

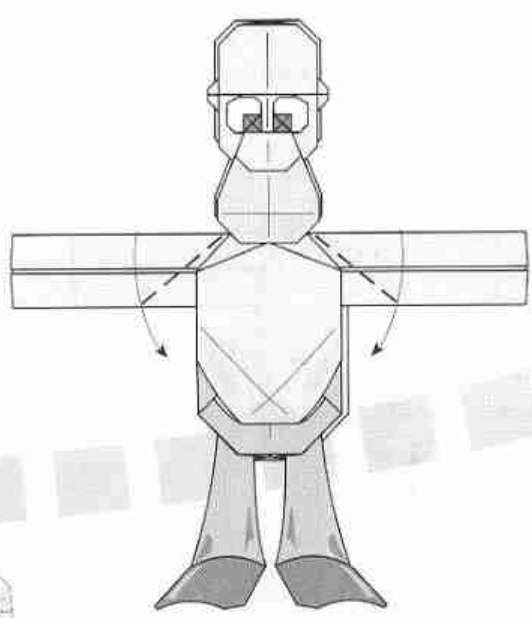
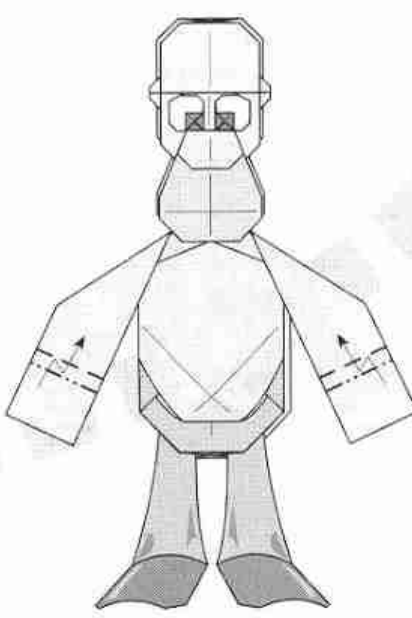
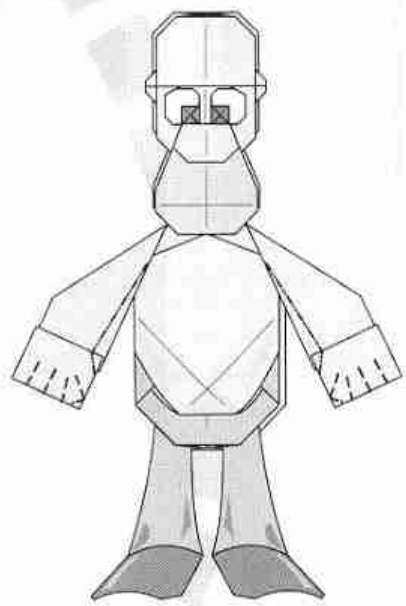
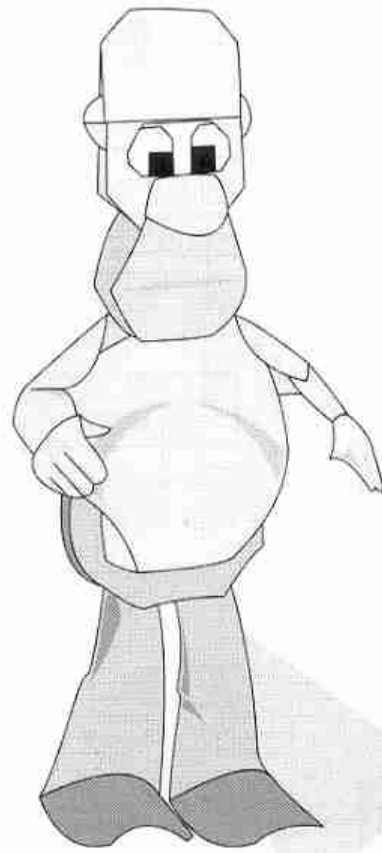

Página (Desarr.)	Pieza nº	Cantidad	Porción	COLORES		Tamaño original	Tamaño 3/10	Tamaño 2/5	Tamaño 3/5
				Anverso	Reverso	16 cm alto	5 cm alto	6,5 cm alto	10 cm alto
						Lado (cm) =	Lado (cm) =	Lado (cm) =	Lado (cm) =
76	1	1	Cara	Blanco	Naranja	20	6	8	12
76	2	1	Cuerpo	Neutro	Naranja	20	6	8	12
76	3	1	Pies	Negro	Blanco	10	3	4	6
78	4	1	Rabo	Negro	Naranja	15	4,5	6	9
79	5	2	Ojos/Cejas	Negro	Naranja	5	1,5	2	3
80	6	1	Boca	Rosa	Negro	5	1,5	2	3

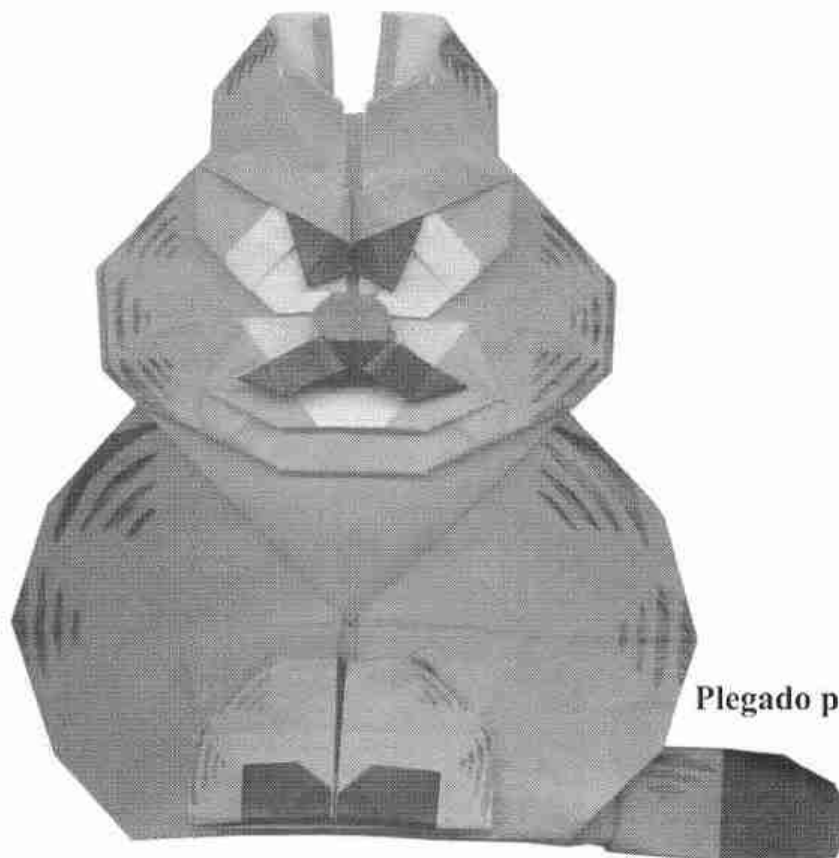

Plegado por: Shai Aharon

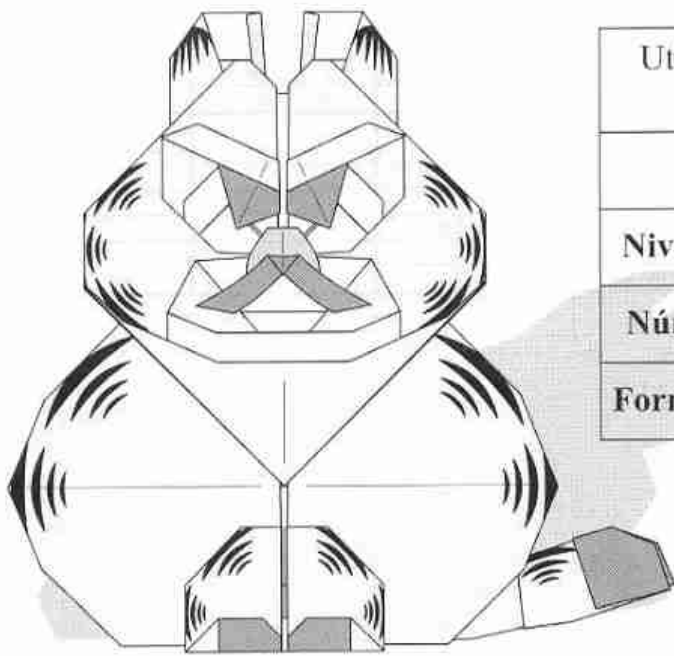

Utilizando las medidas recomendadas, se obtiene un modelo final de 16 cms.

Autor:	Halle
Nivel de dificultad:	Bajo
Número de piezas:	7
Forma de las piezas:	Cuadrados

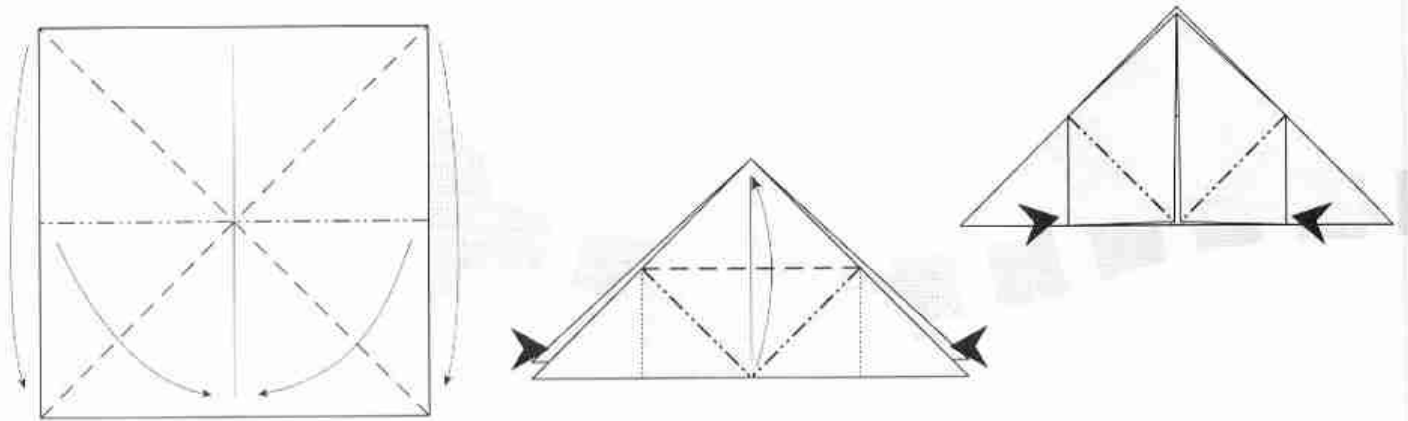

○ Blanco
○ Naranja

□ 20 cm
□ 20 cm

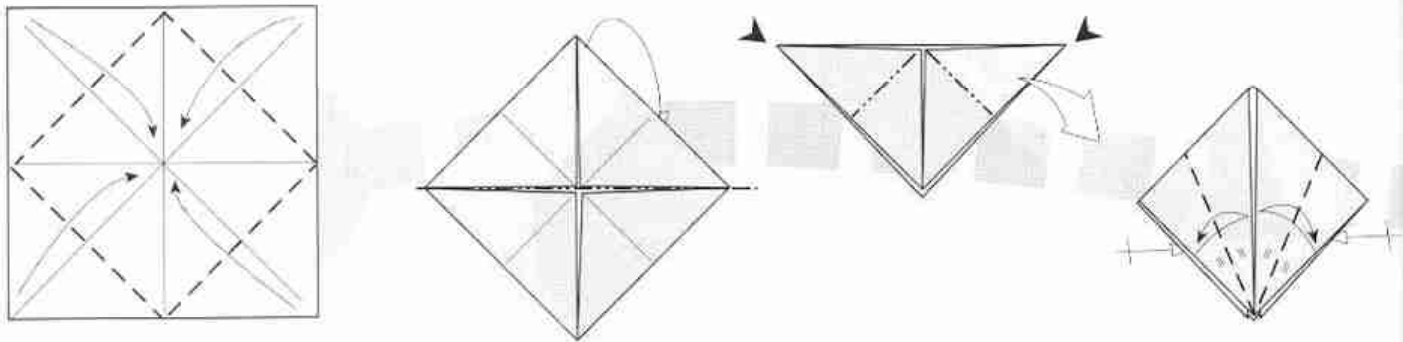

○ Naranja

□ 20 cm
□ 20 cm

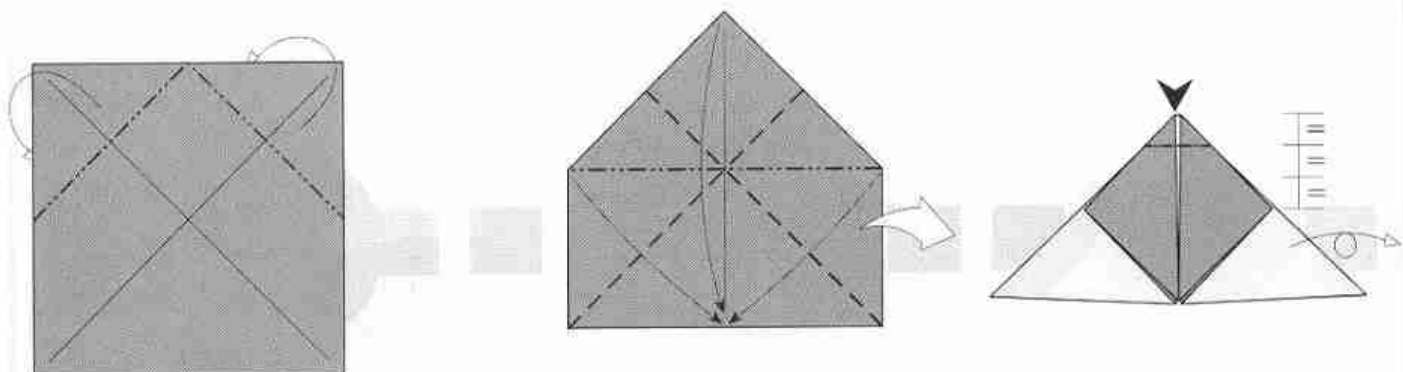

● Negro
○ Blanco

■ 10 cm
■ 10 cm

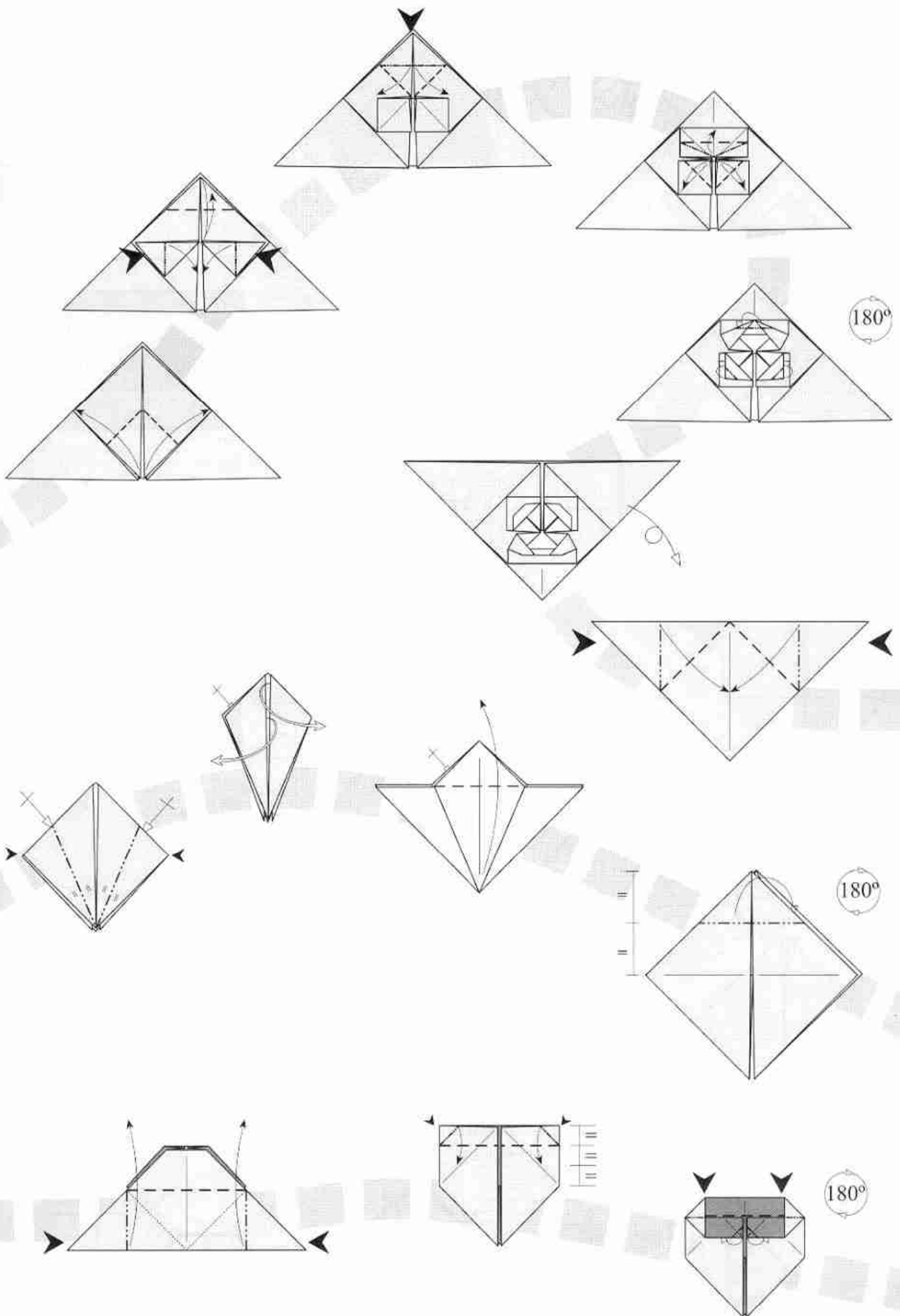

180°

180°

180°



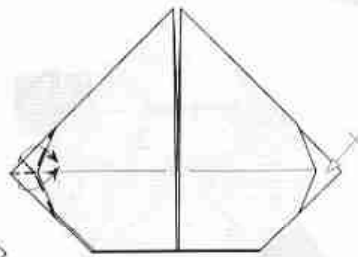
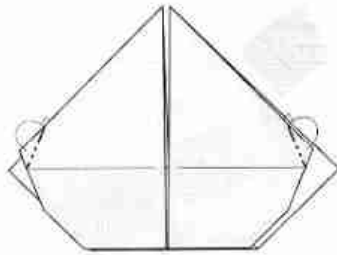
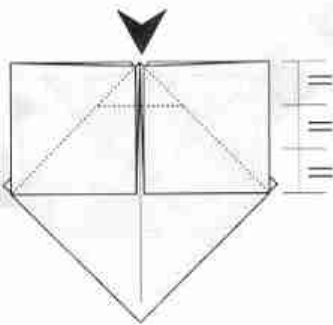
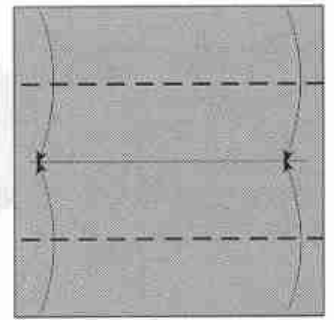
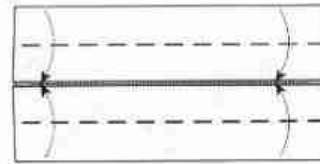
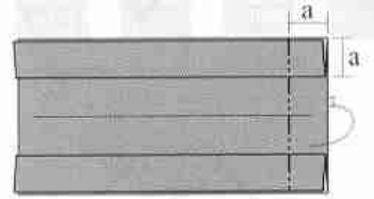
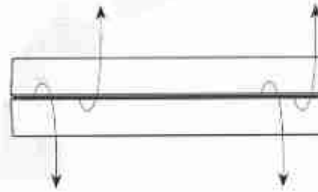
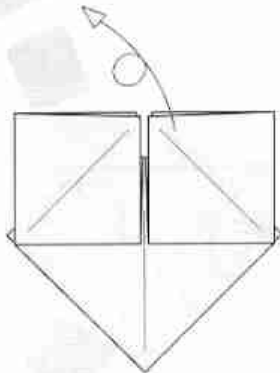
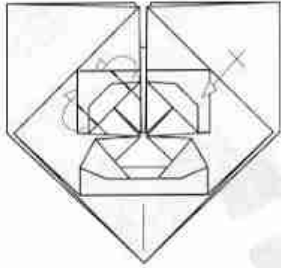
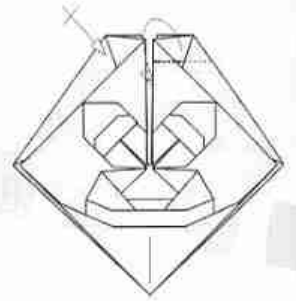
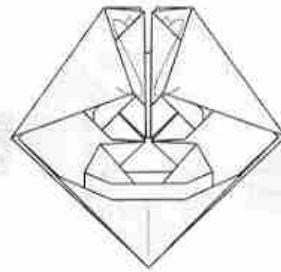
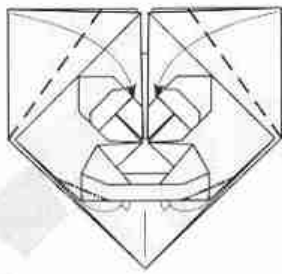

● Negro
○ Naranja

■ 15 cm
□ 15 cm

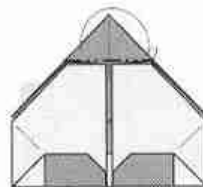
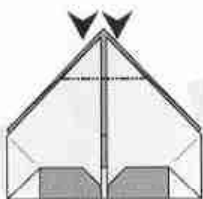
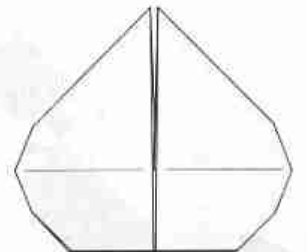
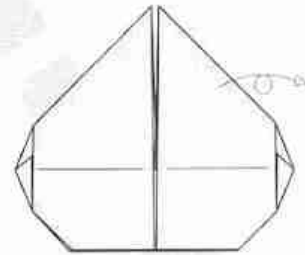
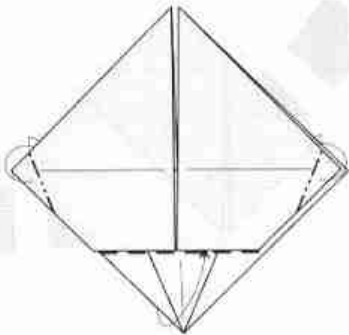

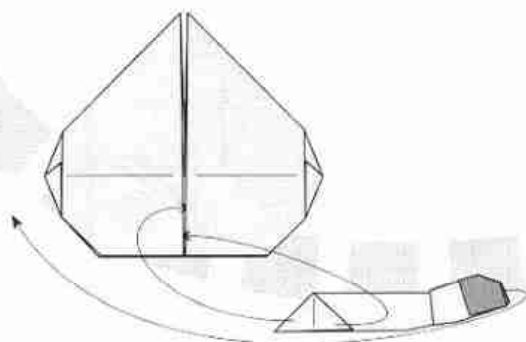
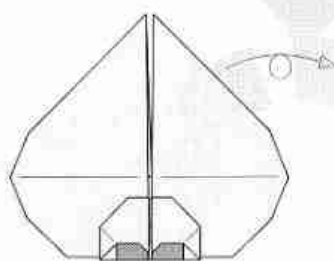
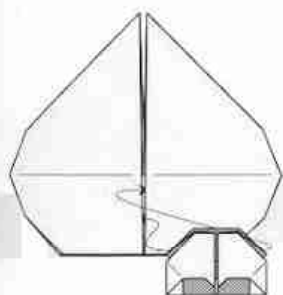
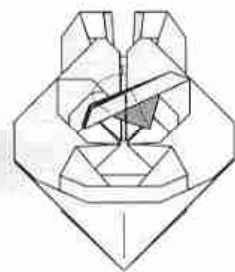
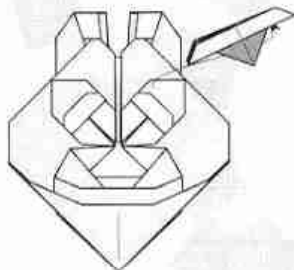
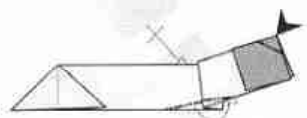
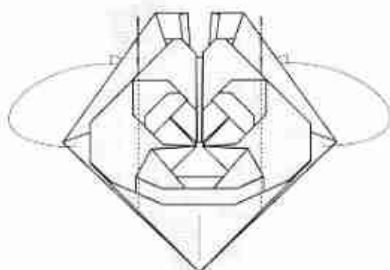
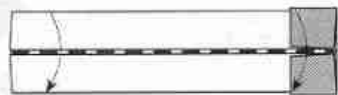
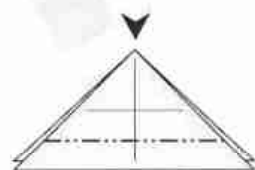
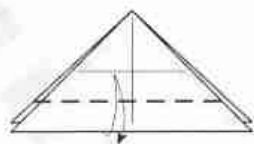
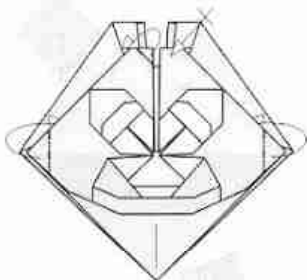
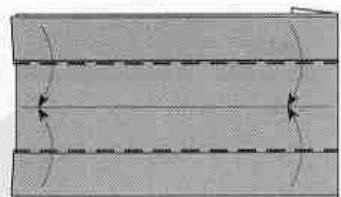
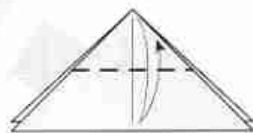
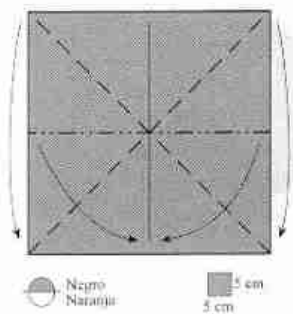
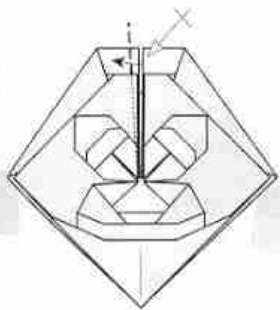

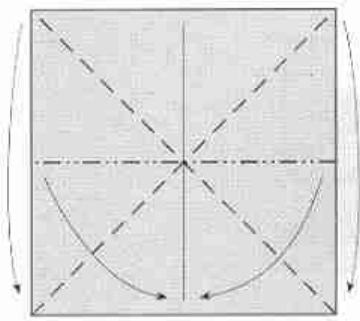

Rosa Negro

5 cm

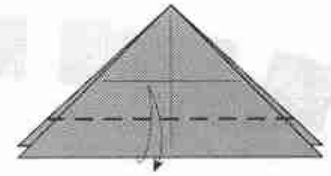
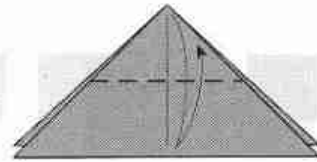

180°

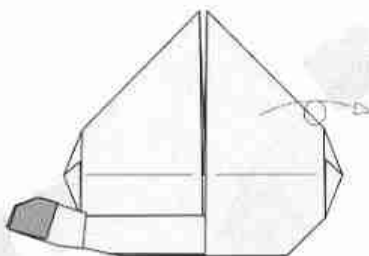
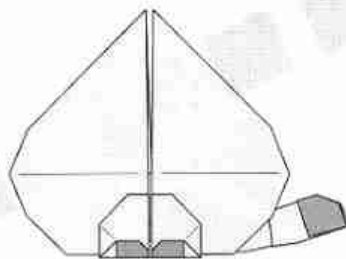
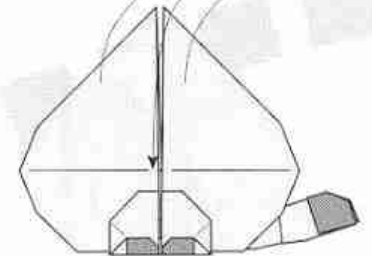
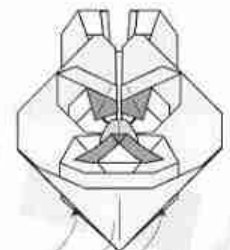
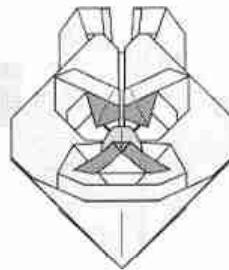
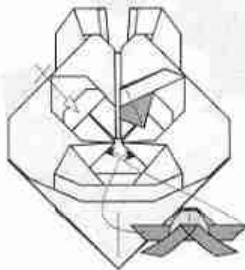
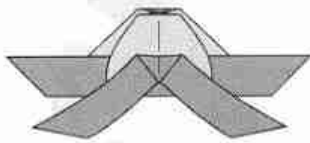
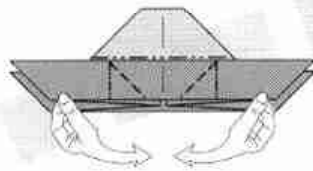
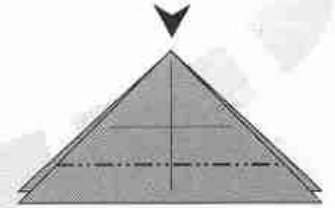

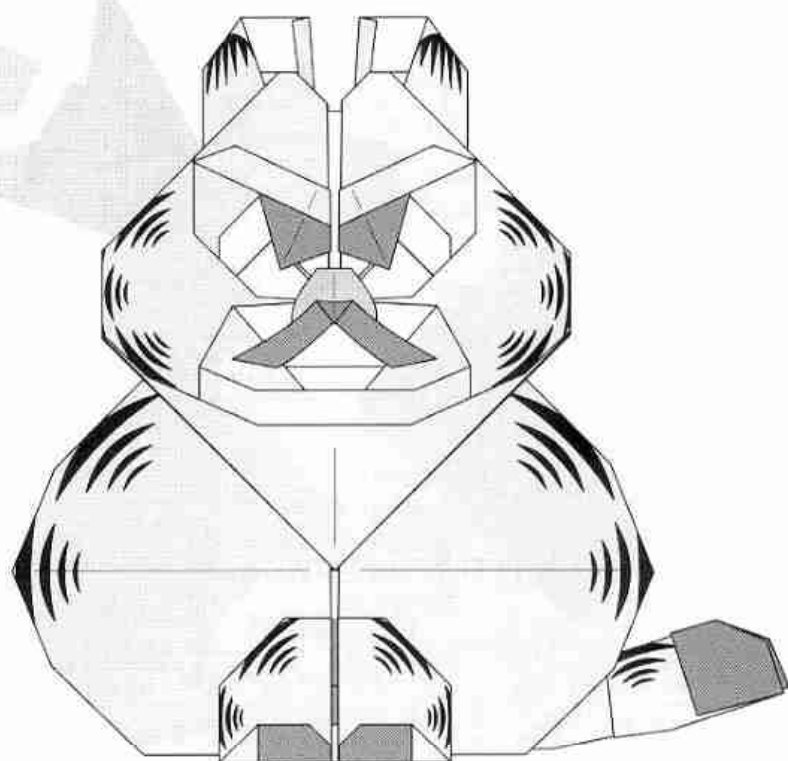
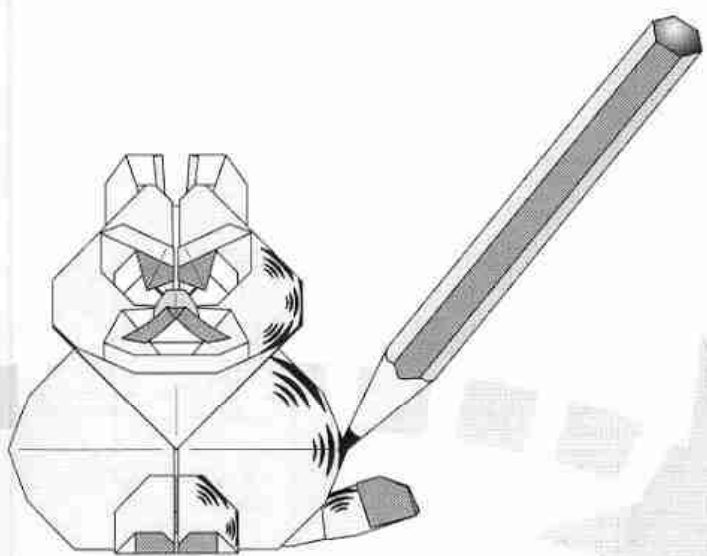

Página (Desarr.)	Pieza nº	Cantidad	Porción	COLORES		Tamaño original	Tamaño 3/10	Tamaño 2/5	Tamaño 3/5
				Anverso	Reverso	15 cm alto	4,5 cm alto	6 cm alto	9 cm alto
						Lado (cm) =	Lado (cm) =	Lado (cm) =	Lado (cm) =
83	1	1	Cabeza	Neutro	Amarillo	15	4,5	6	9
83	2	1	Resto cuerpo	Negro	Amarillo	20	6	8	12
84	3	1	Orejas	Neutro	Negro	10	3	4	6
85	4	1	Ojos	Negro	Blanco	5	1,5	2	3
86	5	1	Morrito	Negro	Negro	5	1,5	2	3

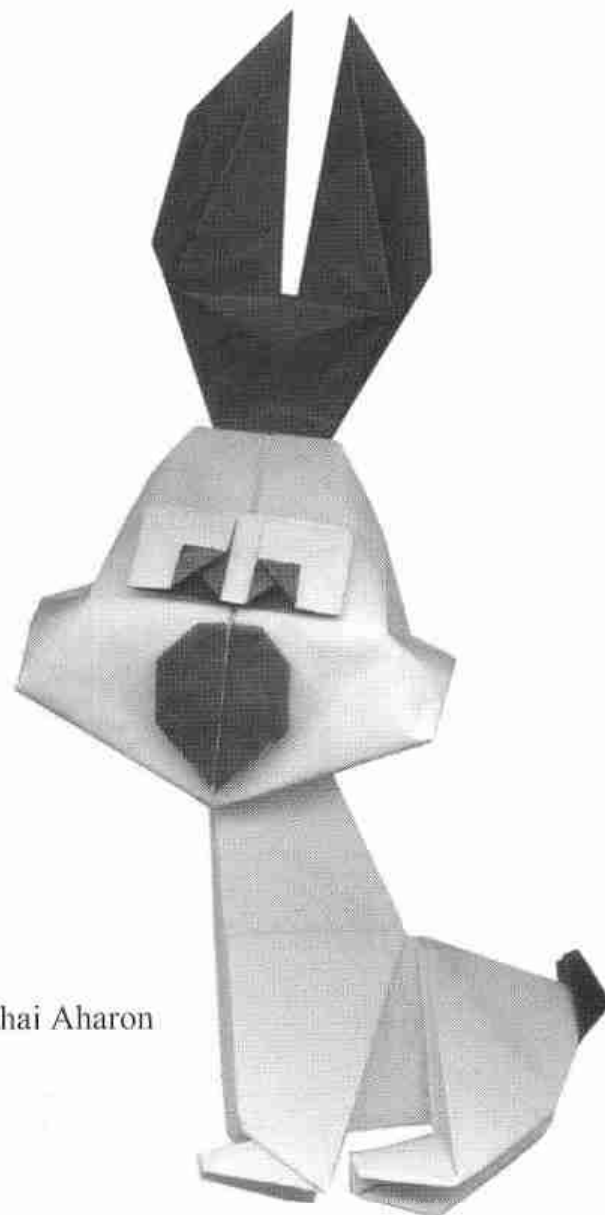

Plegado por: Shai Aharon

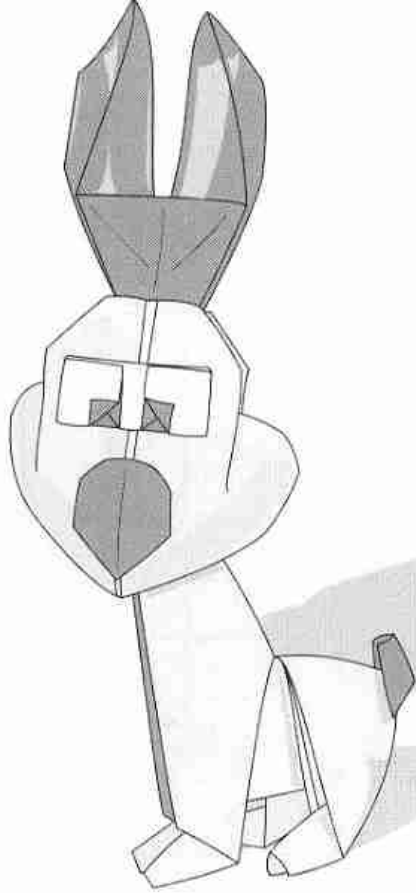

Utilizando las medidas recomendadas, se obtiene un modelo final de 15 cms.

Autor:	Halle
Nivel de dificultad:	Medio
Número de piezas:	5
Forma de las piezas:	Cuadrados

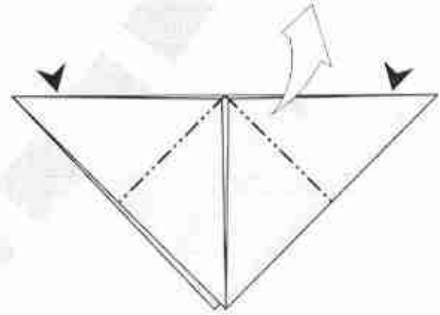
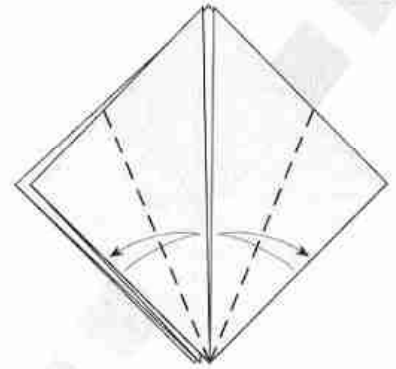

45°

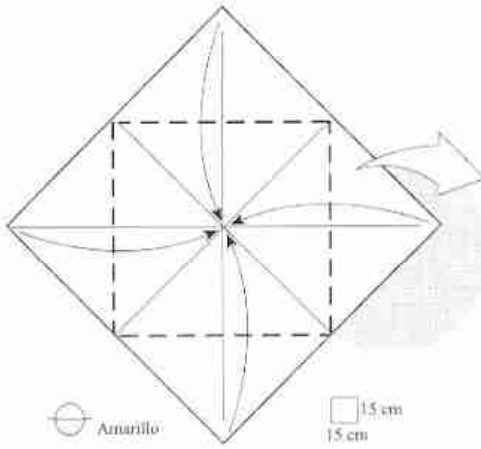
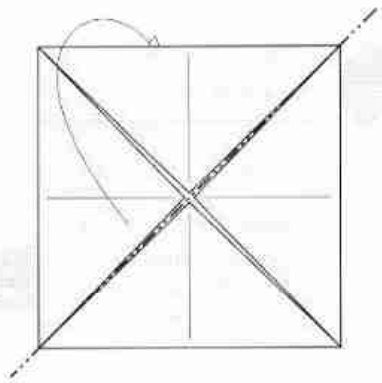

● Amarillo □ 15 cm 15 cm

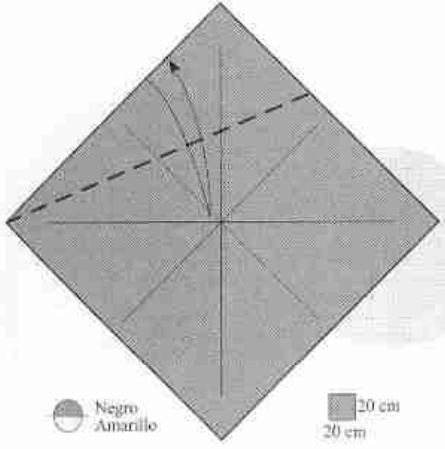
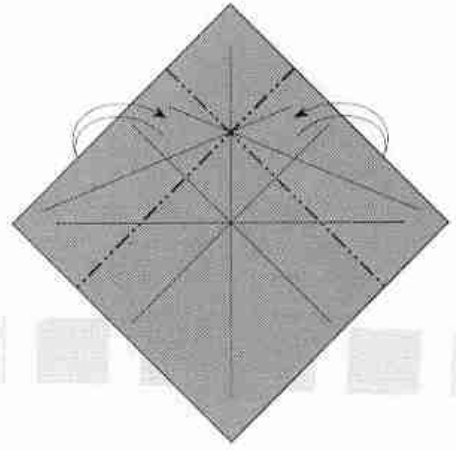
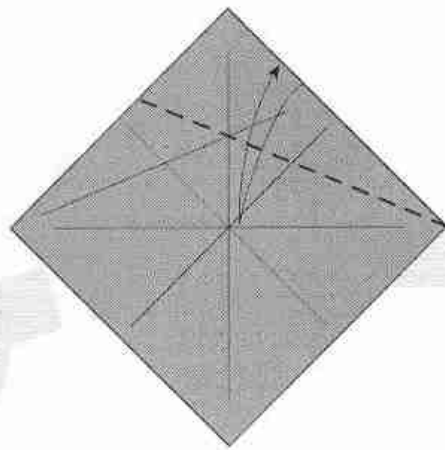

● Negro ● 20 cm 20 cm

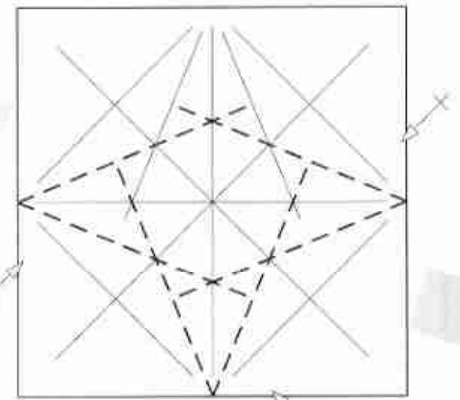
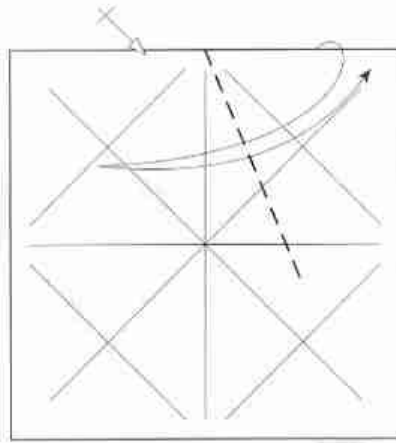
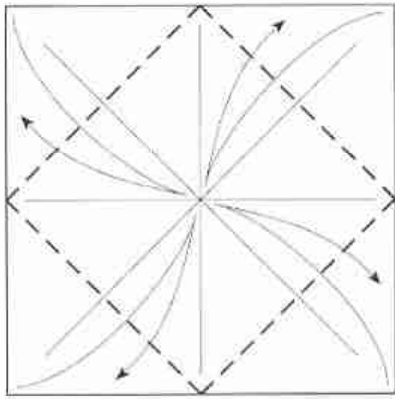
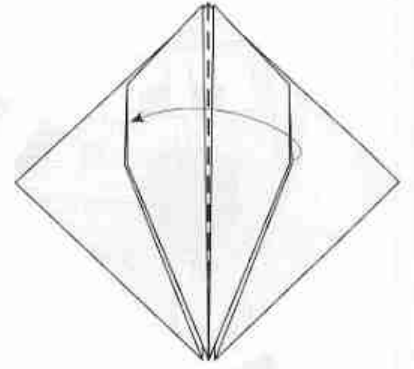
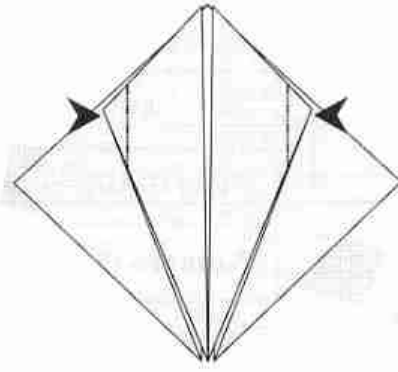
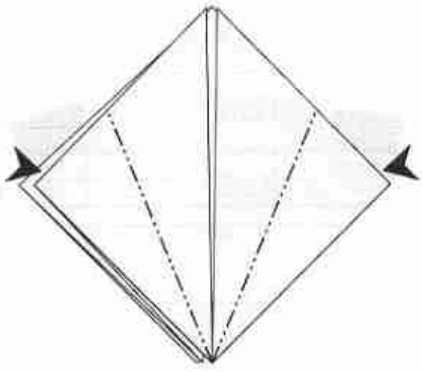

● Negro

□ 10 cm
10 cm

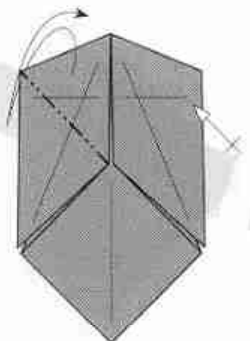
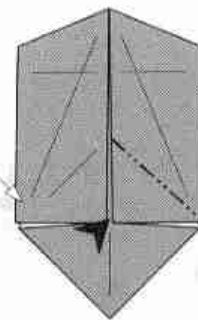
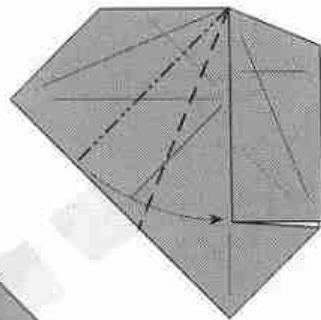
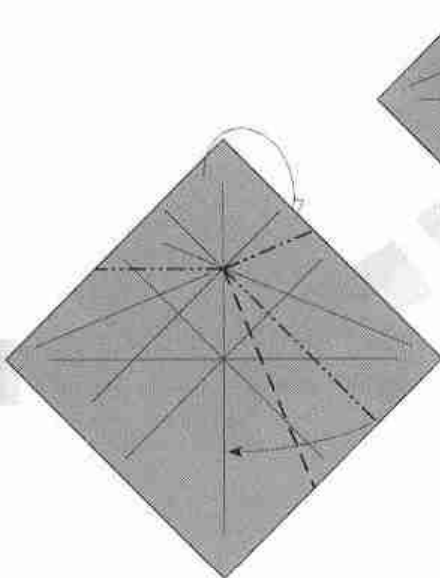

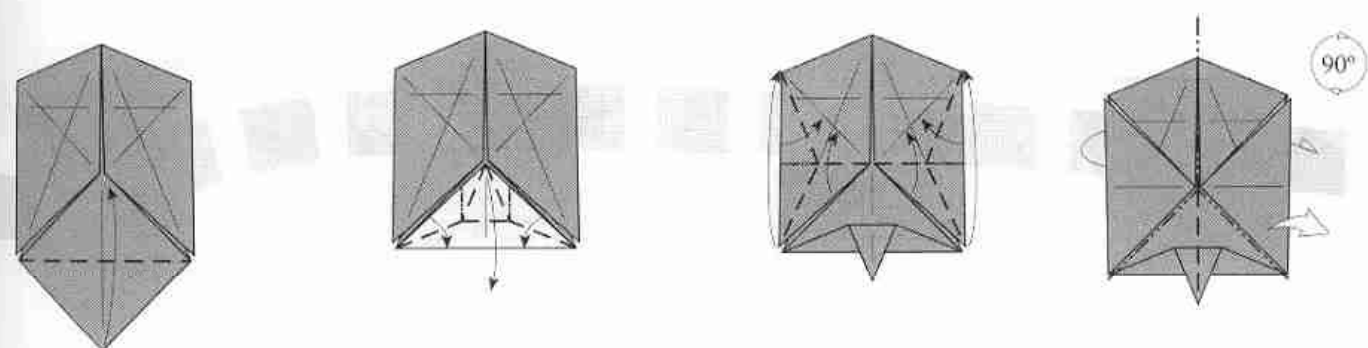
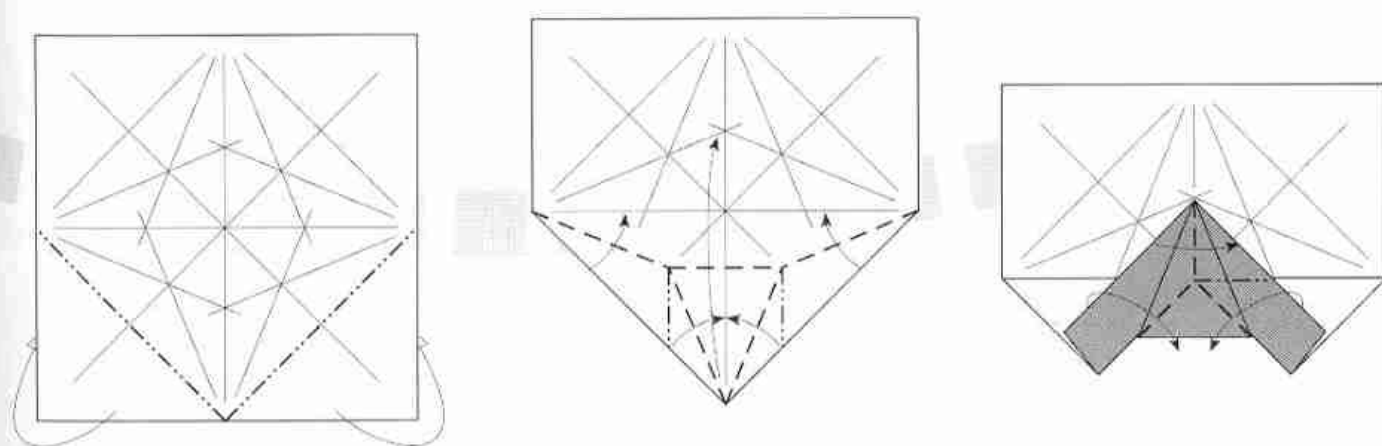
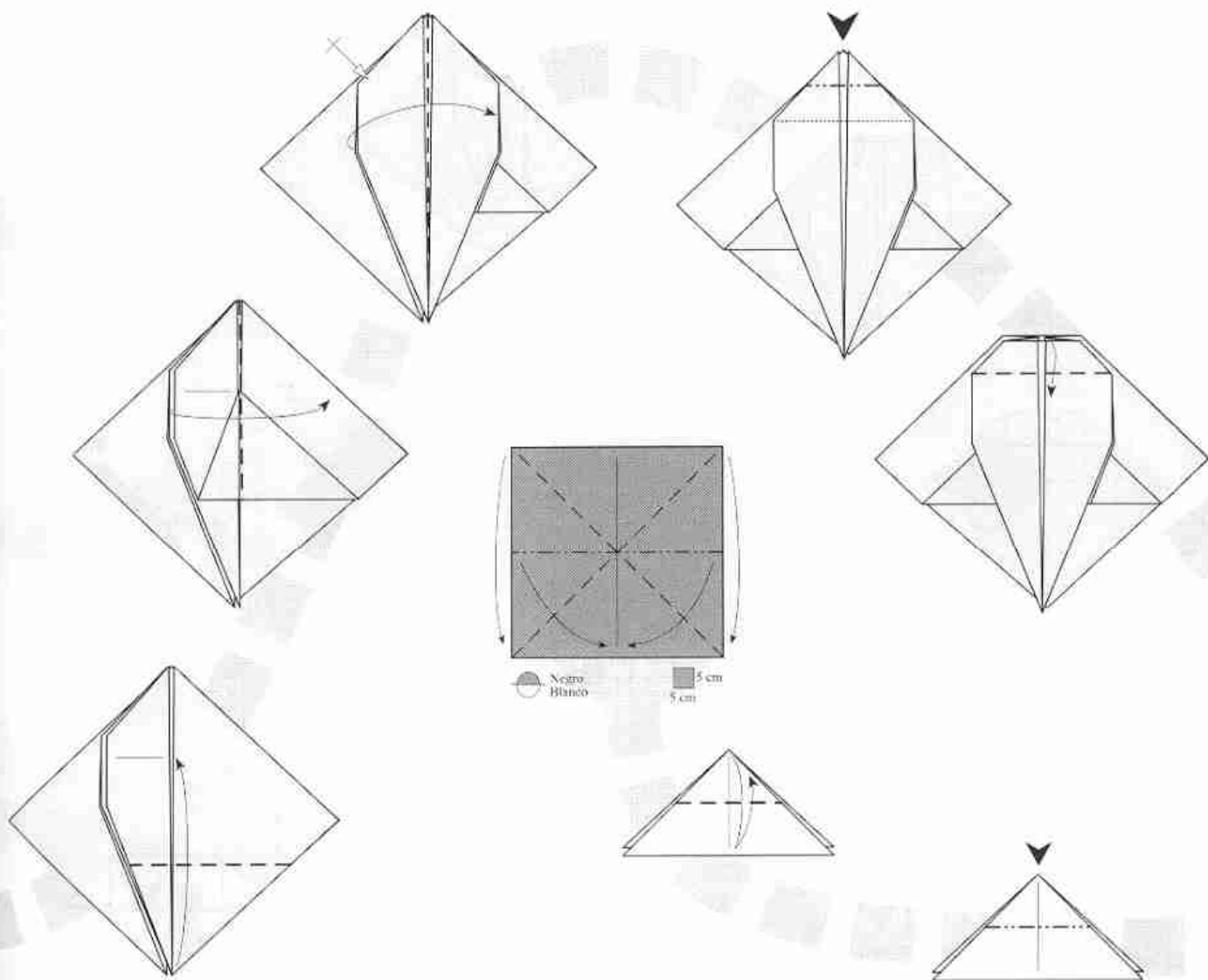

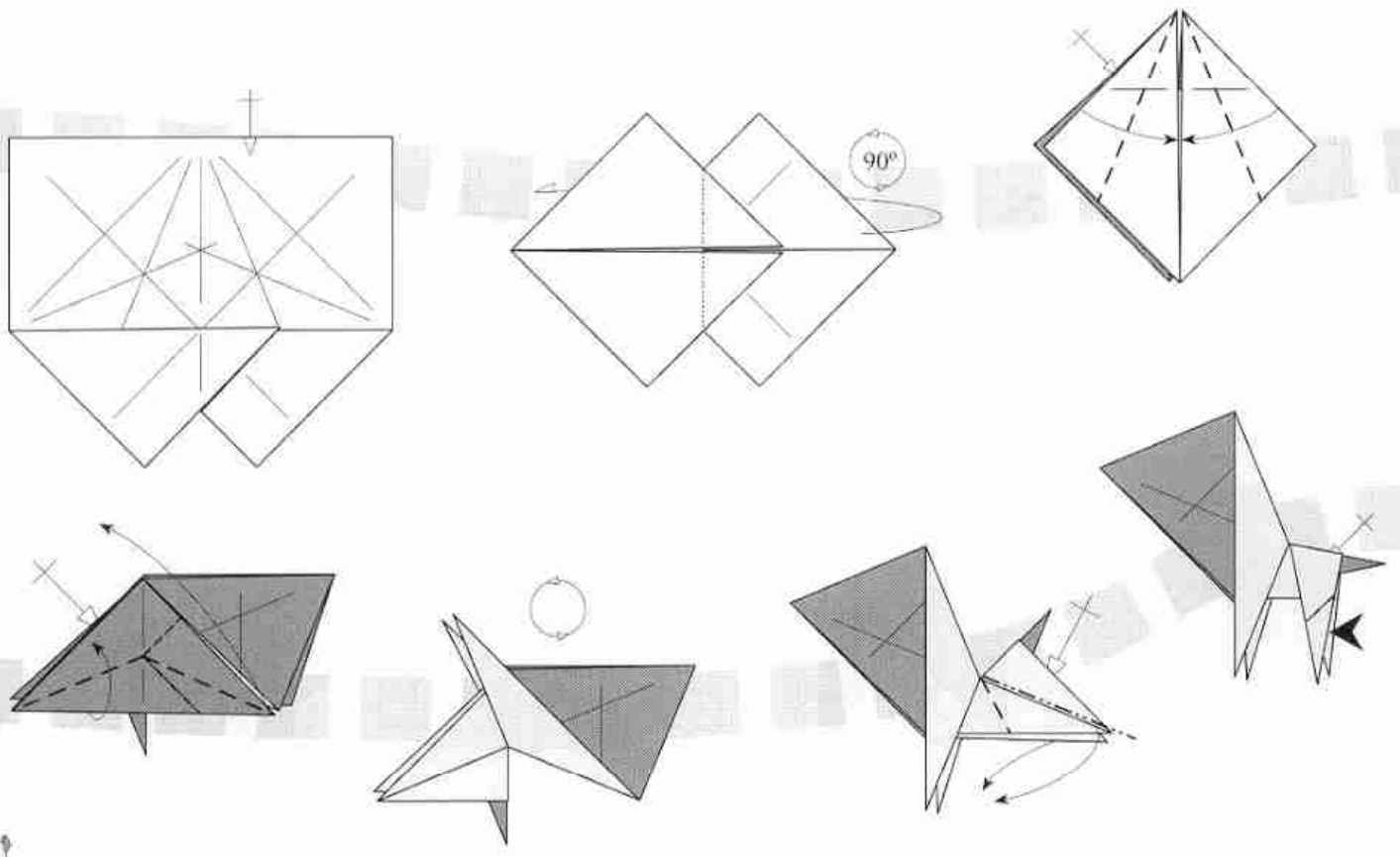
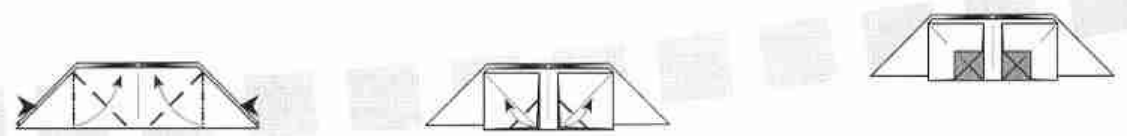
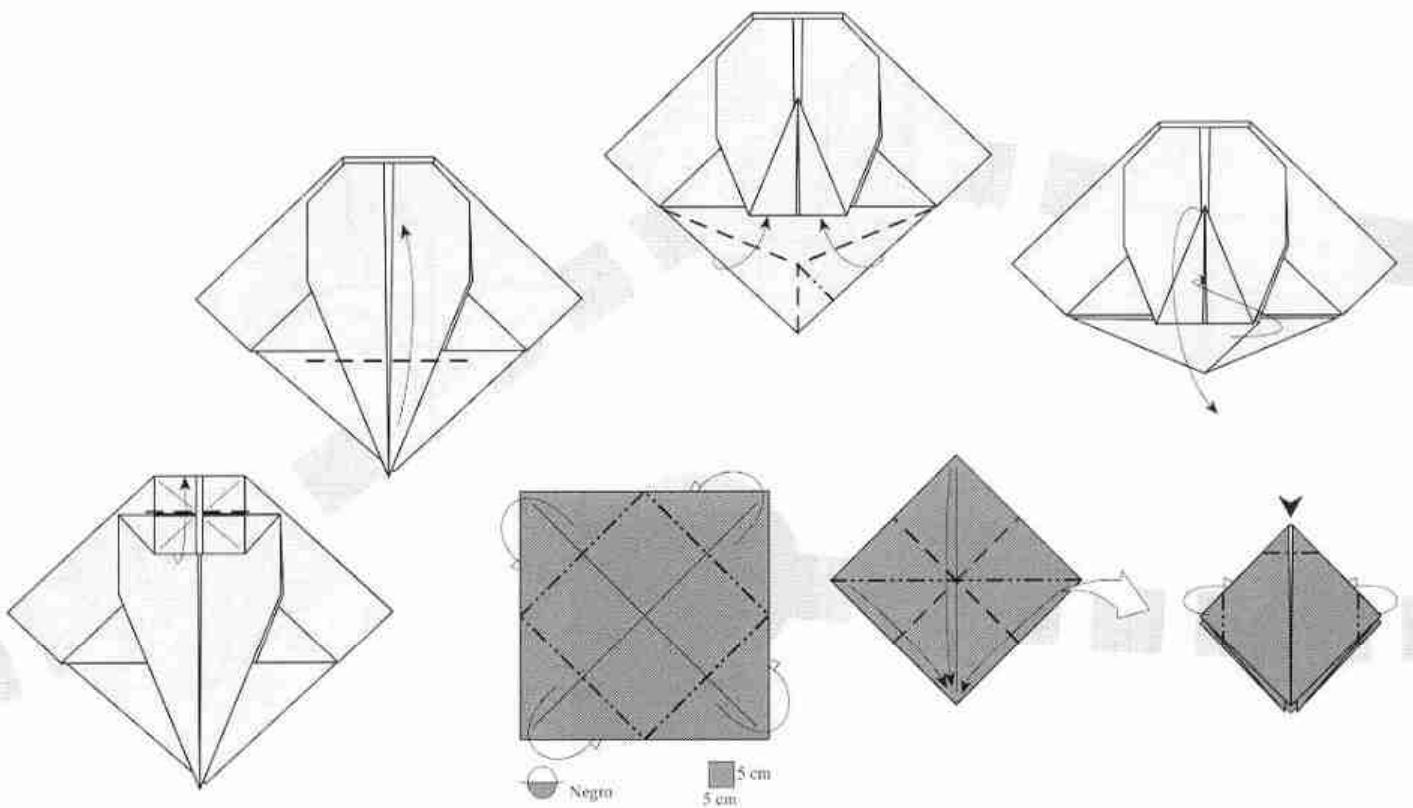

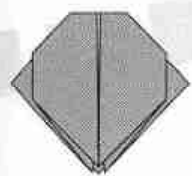
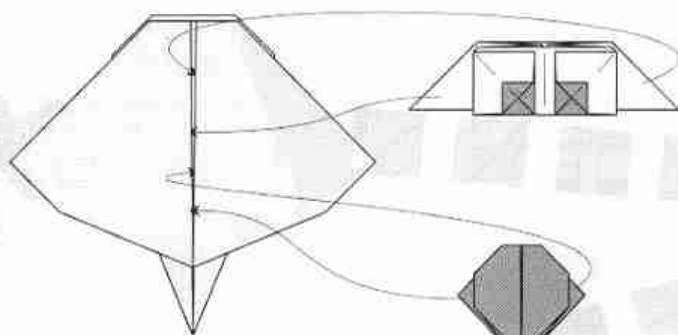
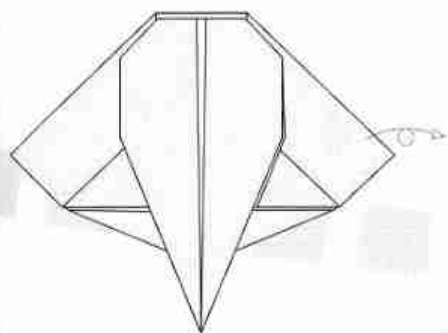

180°

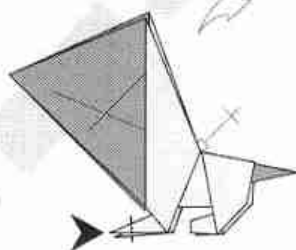
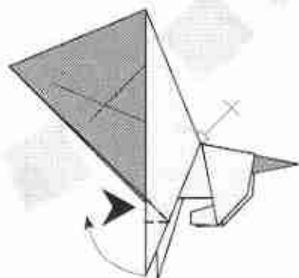
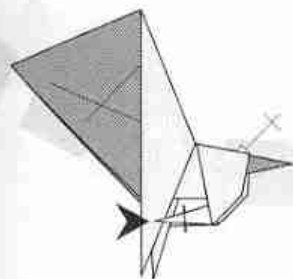
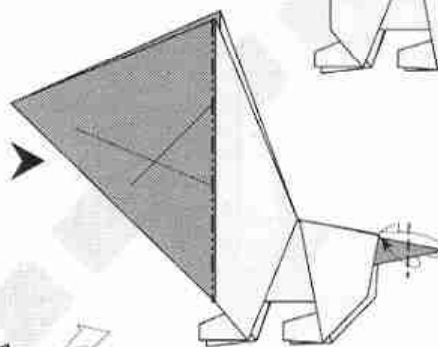
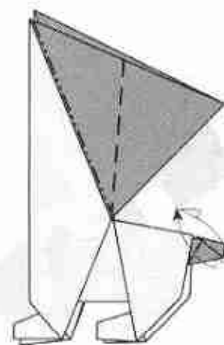
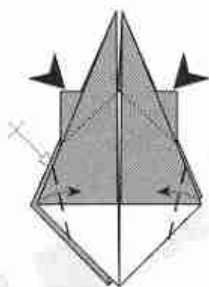
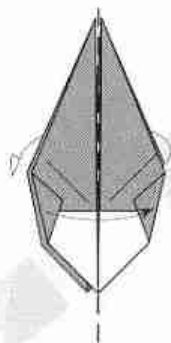
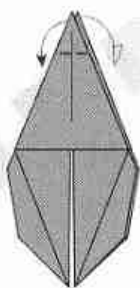

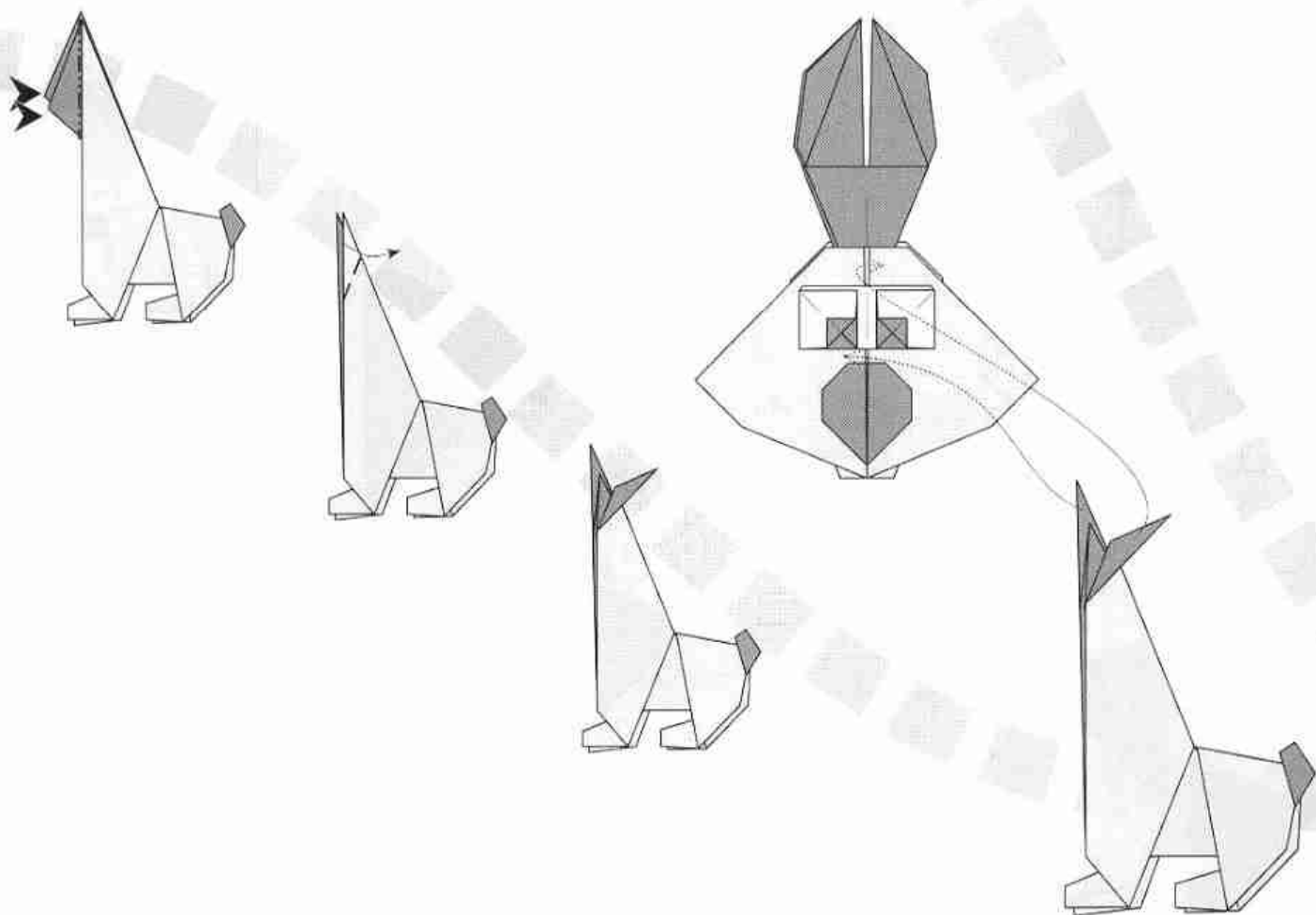
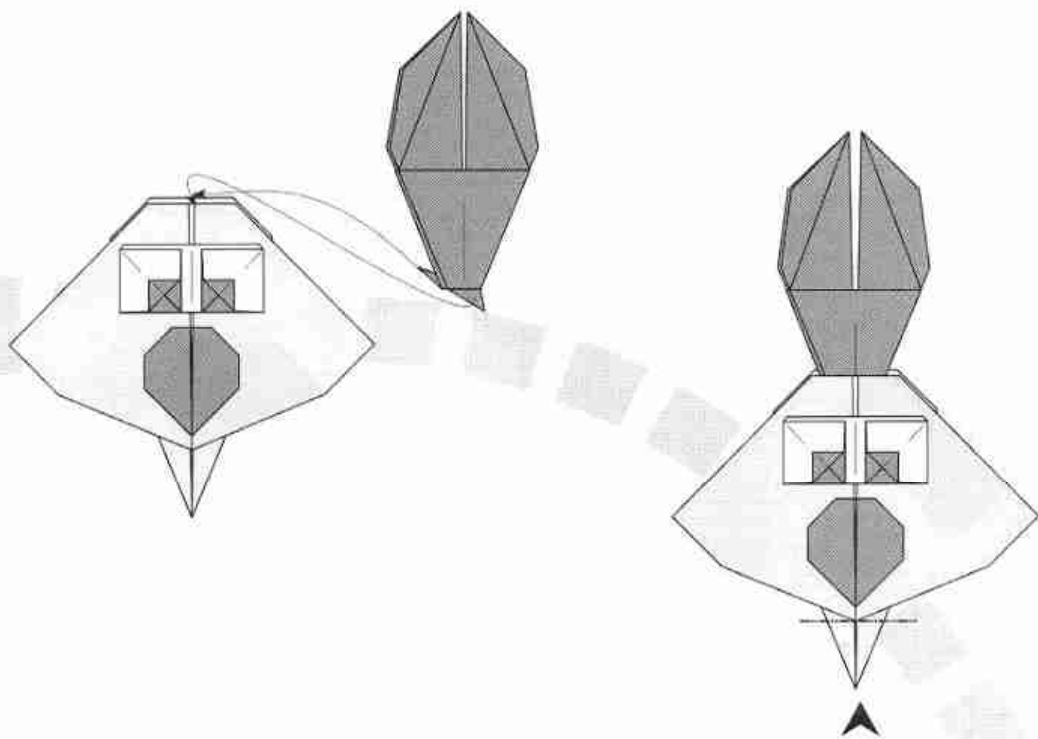

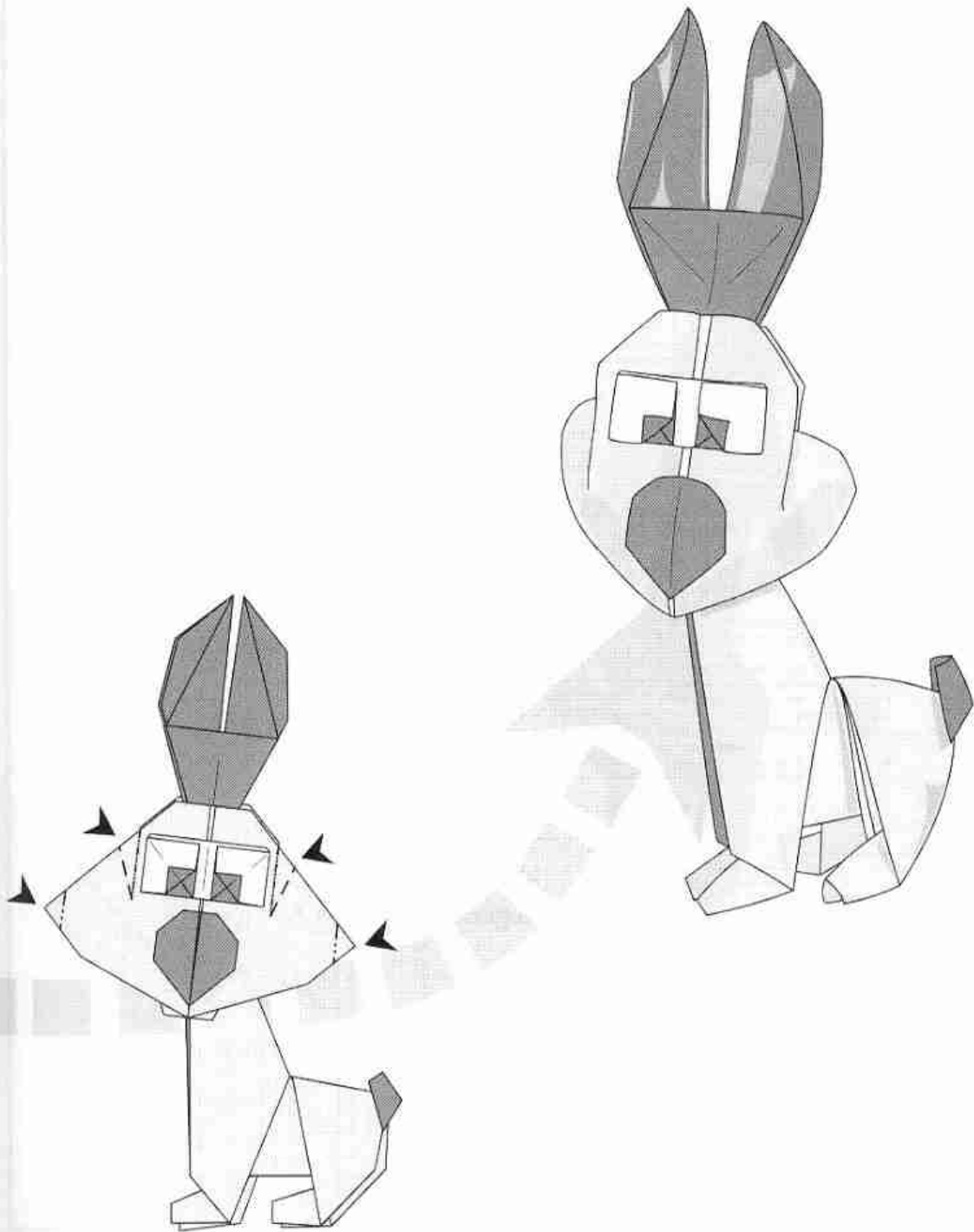

Página (Desarr.)	Pieza nº	Cantidad	Porción	COLORES		Tamaño original	Tamaño 3/10	Tamaño 2/5	Tamaño 3/5
				Anverso	Reverso	15 cm alto	4,5 cm alto	6 cm alto	9 cm alto
						Lado (cm) =	Lado (cm) =	Lado (cm) =	Lado (cm) =
91	1	1	Cabeza	Rosa	Blanco	15	4,5	6	9
93	2	1	Cuerpo	Blanco	Rosa	20	6	8	12
94	3	2	Piernas	Rosa	Rosa	10	3	4	6
95	4	2	Brazos	Rosa	Rosa	5	1,5	2	3
97	5	1	Rabo	Rosa	Rosa	5	1,5	2	3

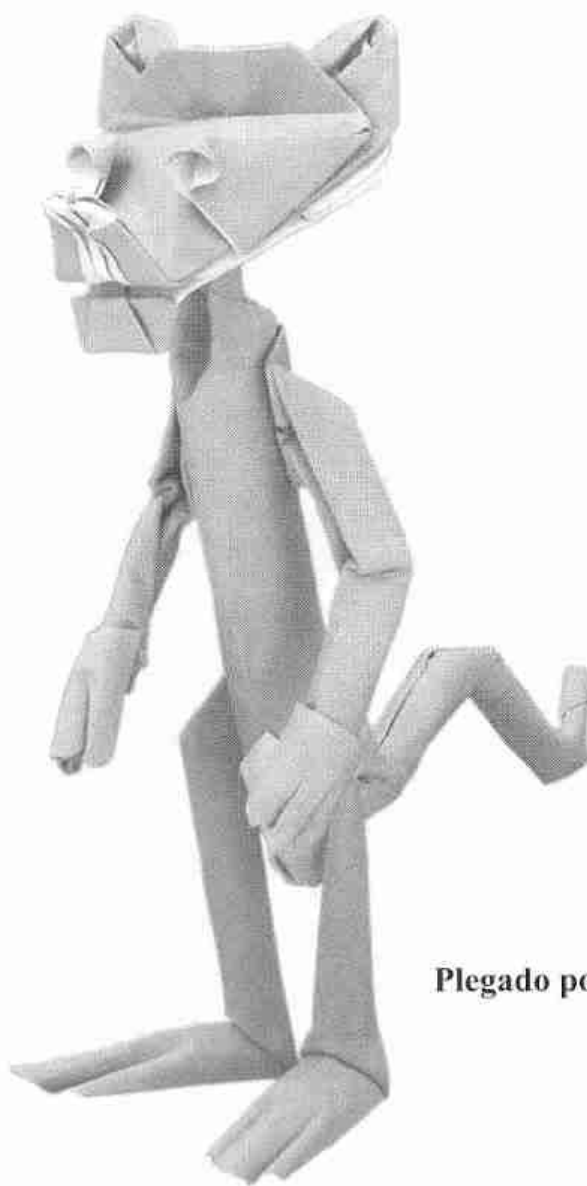

Plegado por: J.A.V.I.

Utilizando las medidas recomendadas, se obtiene un modelo final de 15 cms.

Autor:	Halle
Nivel de dificultad:	Medio-Alto
Número de piezas:	7
Forma de las piezas:	Cuadrados

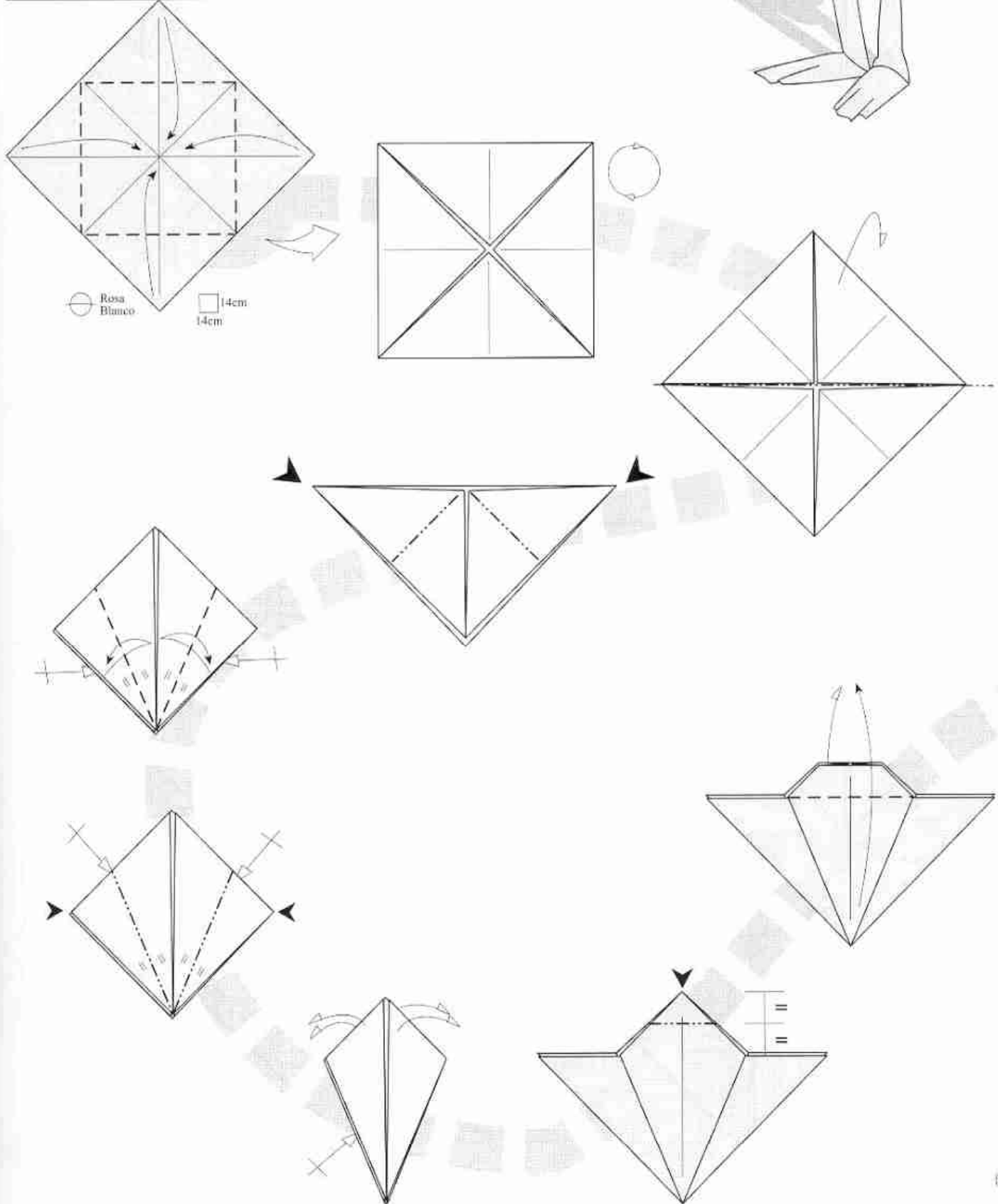
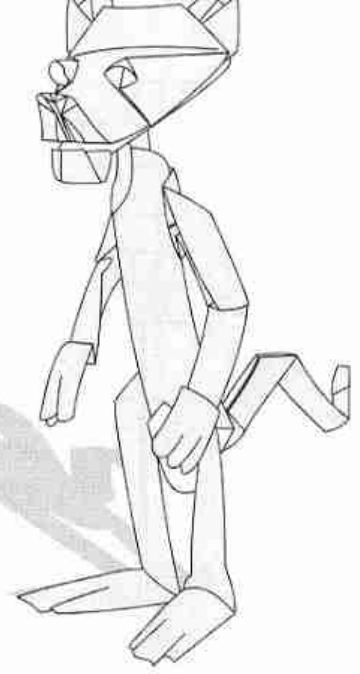

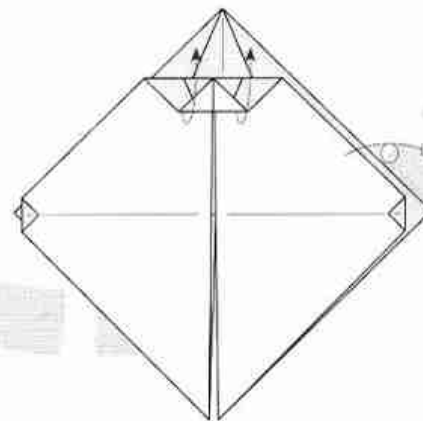
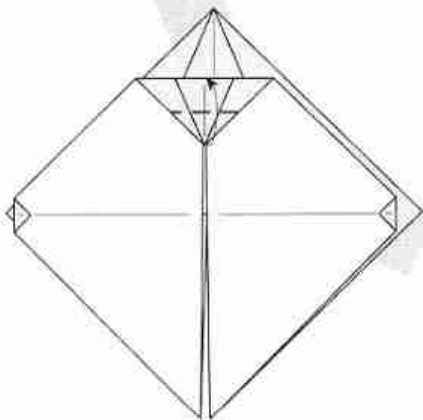
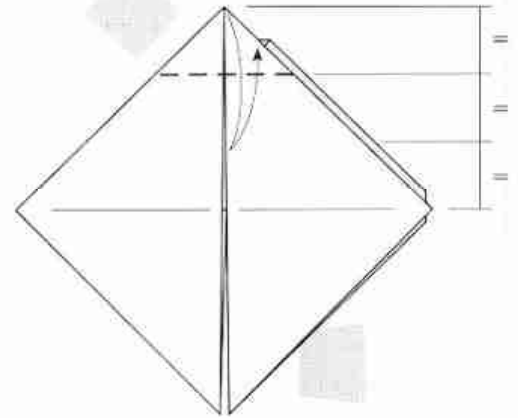
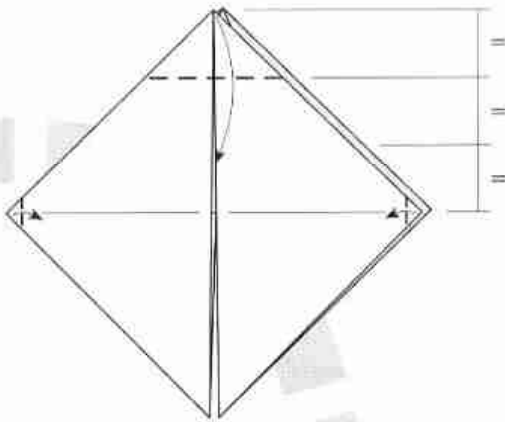
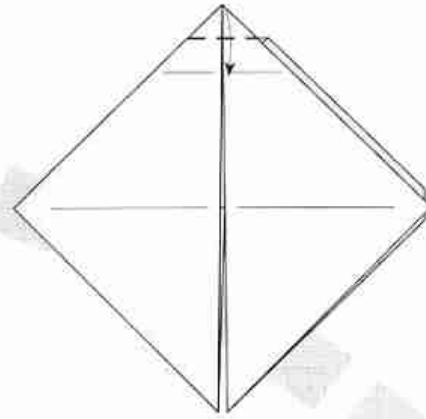
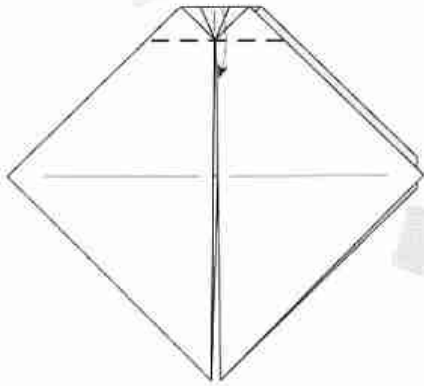
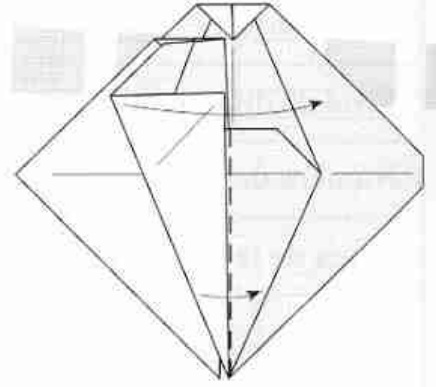
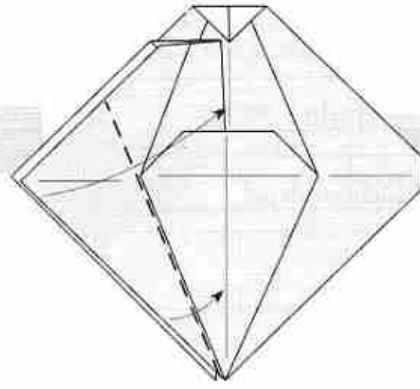
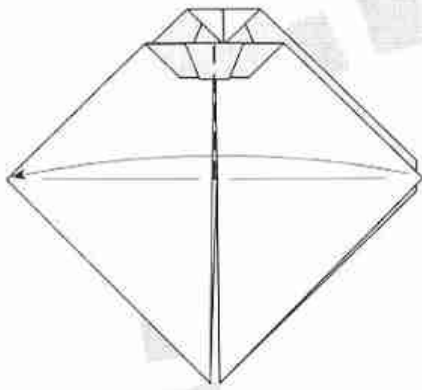

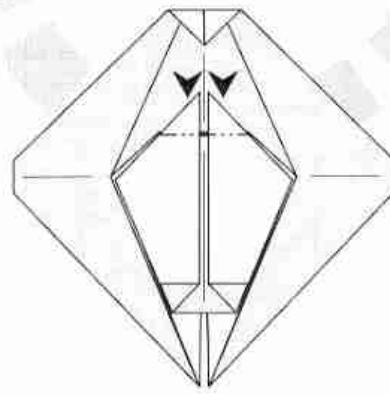
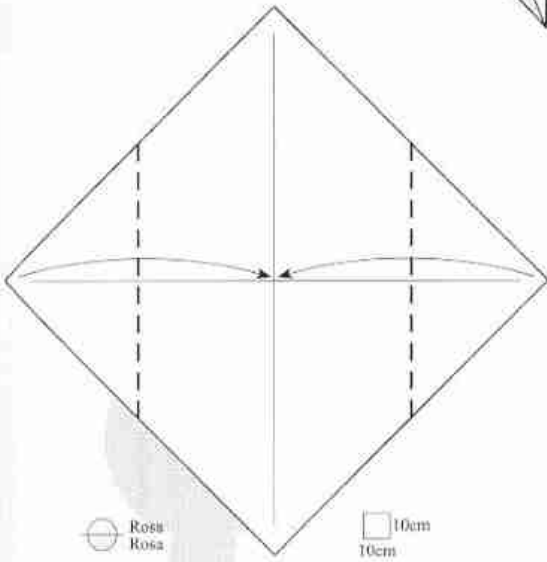
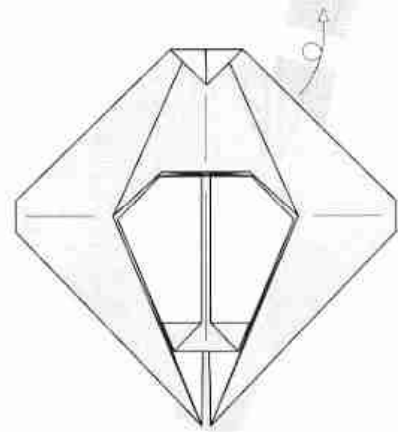
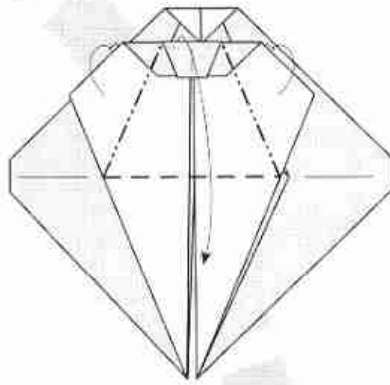
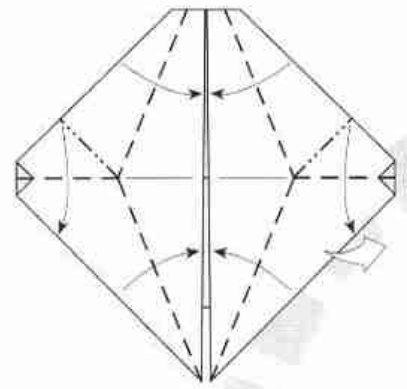
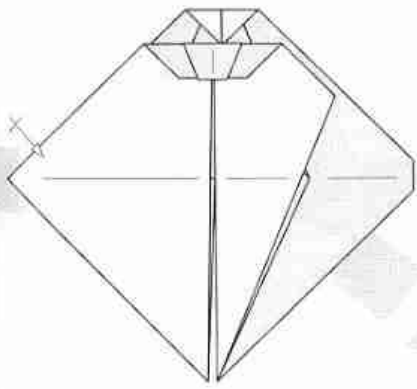

⊕ Rosa
⊖ Rosa

□ 10cm
□ 10cm

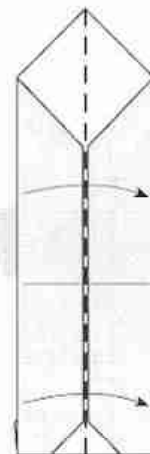
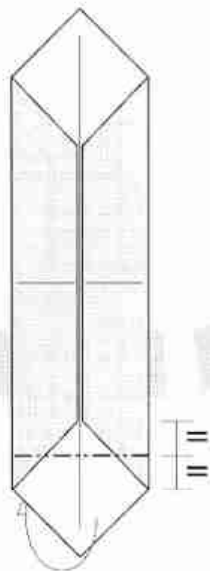
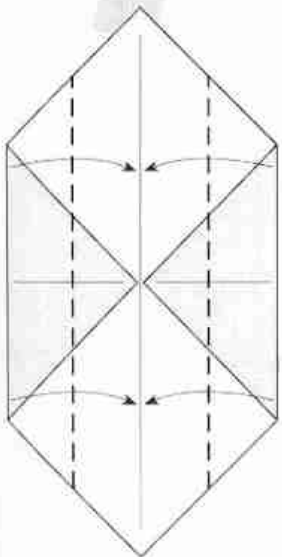

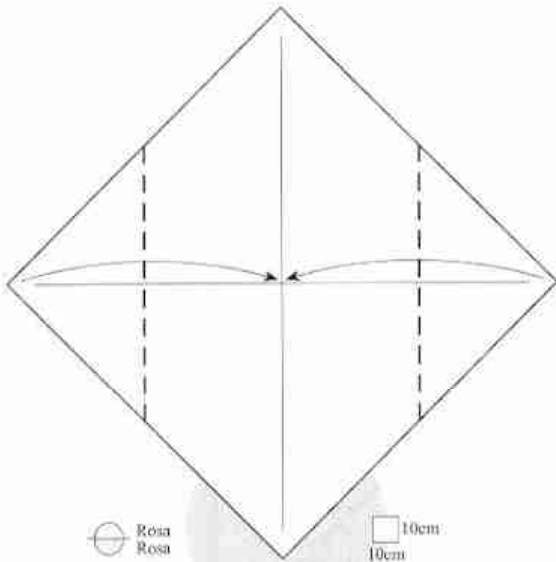
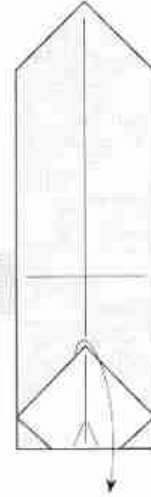
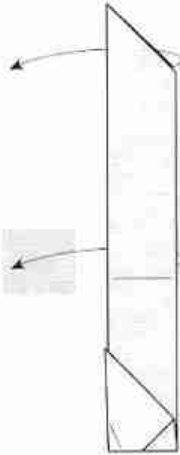
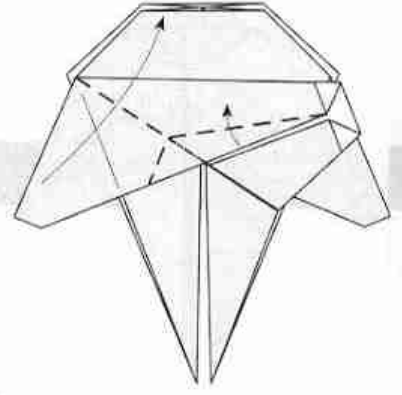
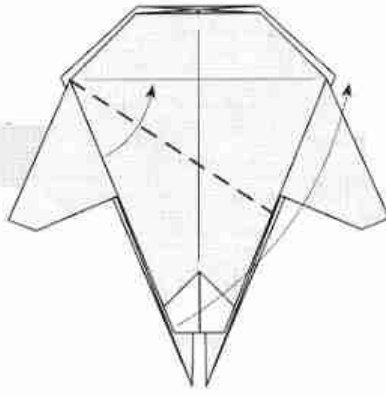
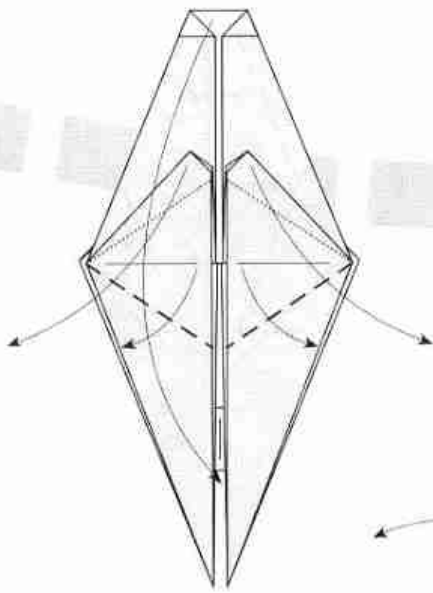

Rosa
Rosa

10cm
10cm

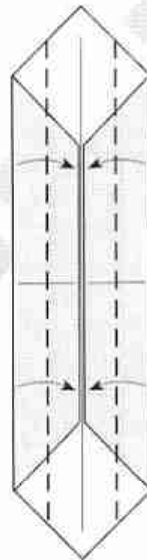
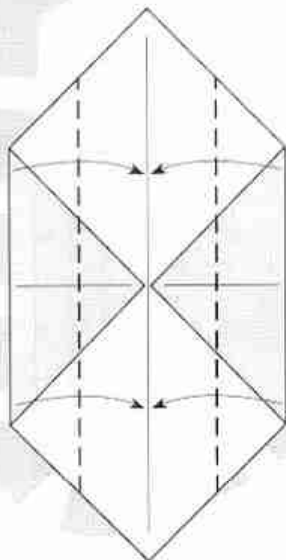

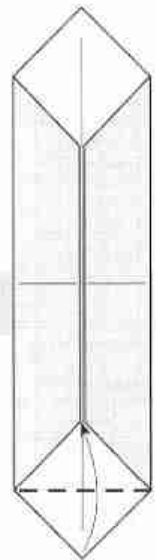
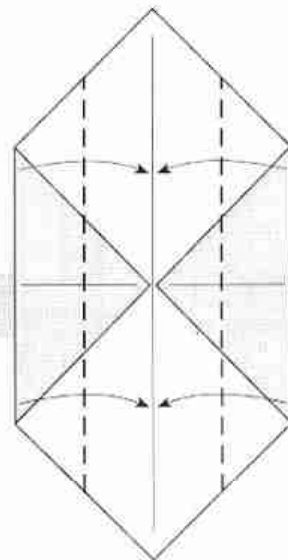
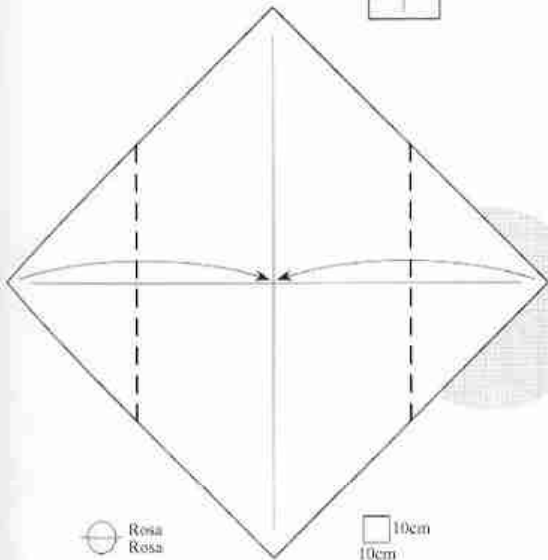
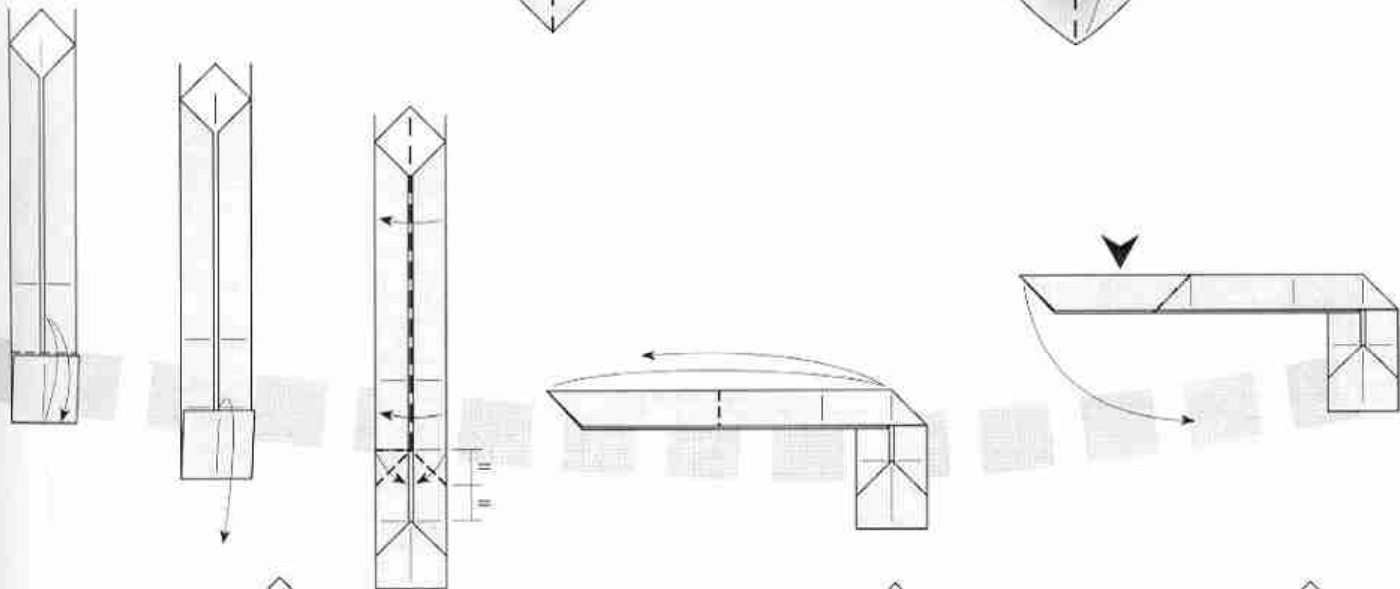
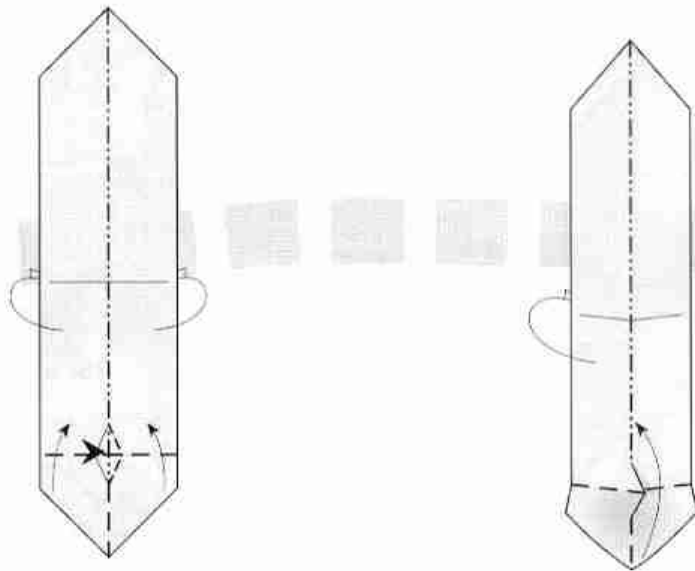
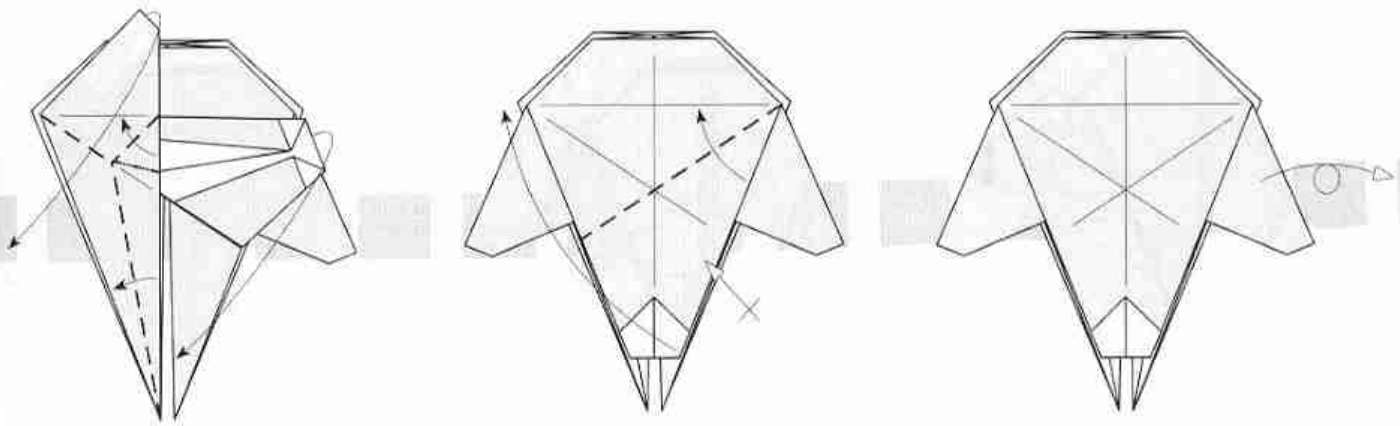

Rosa
Rosa

10cm
10cm



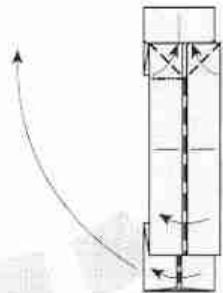
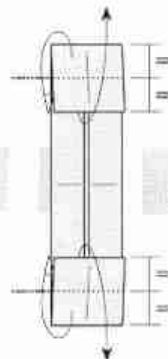
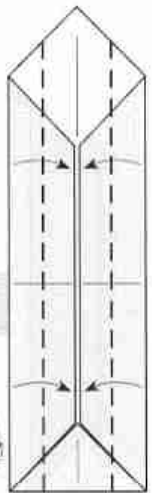
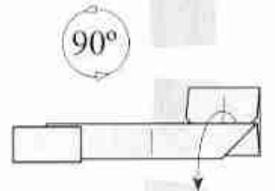
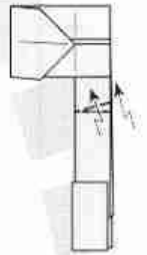
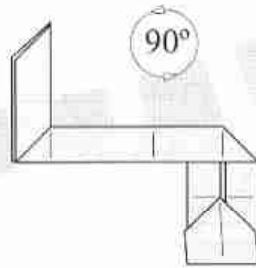
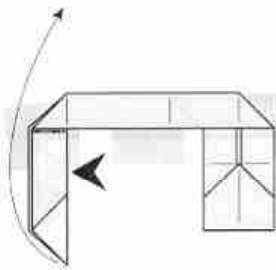
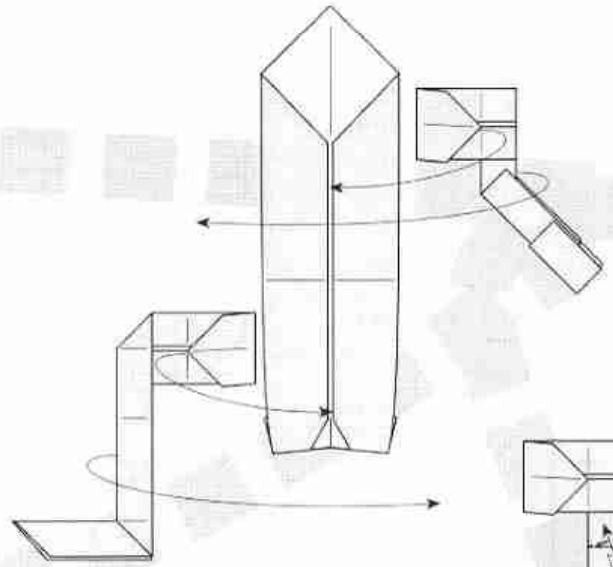
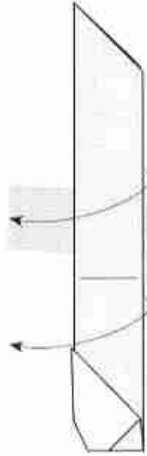
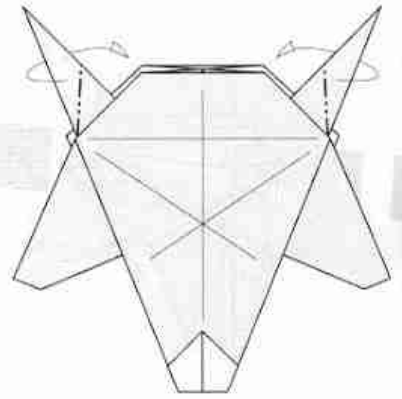
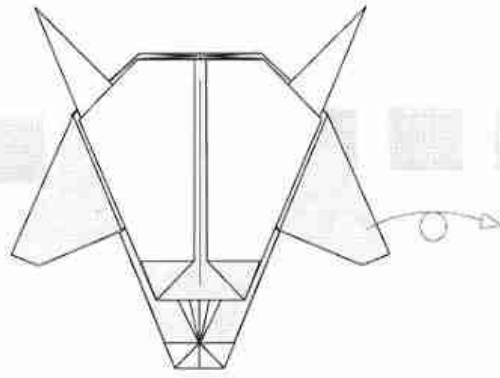
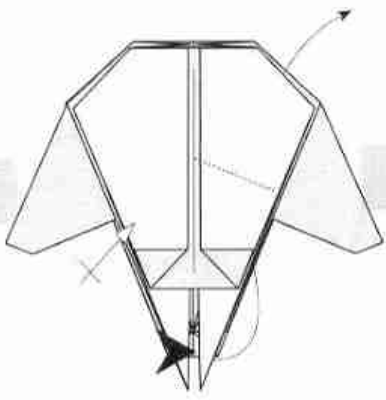

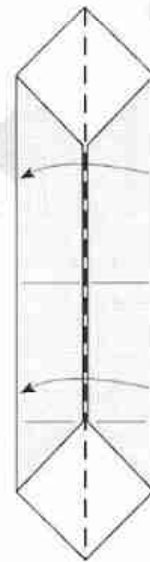
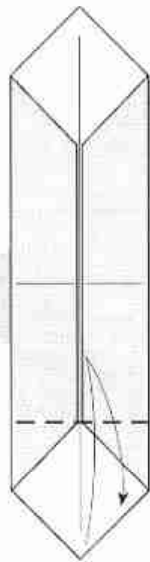
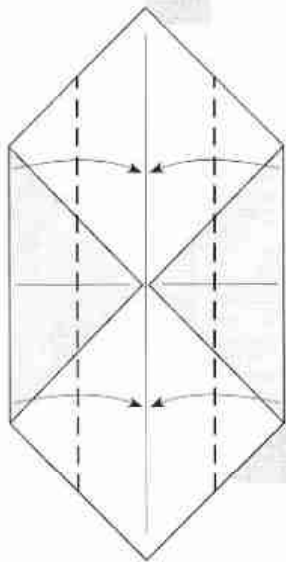
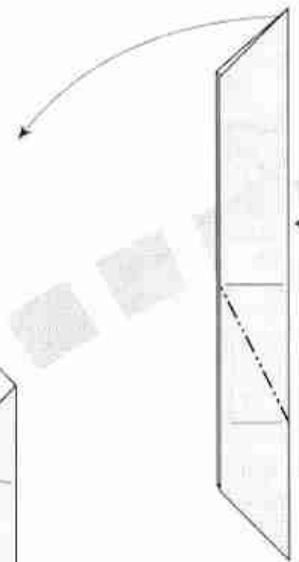
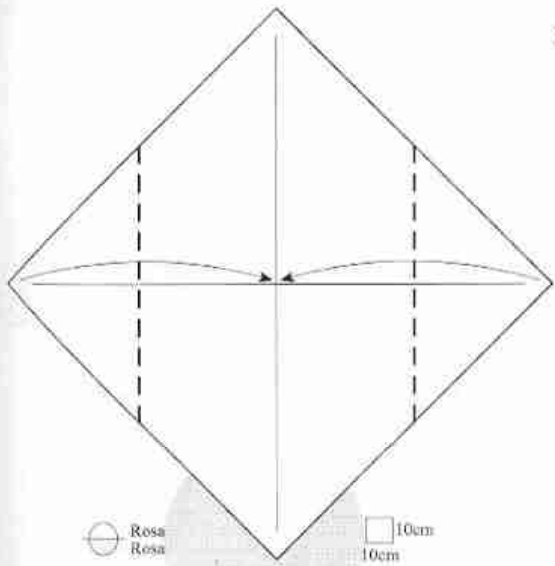
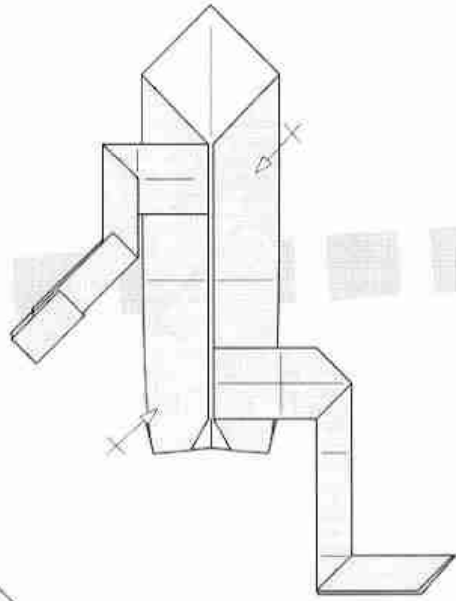
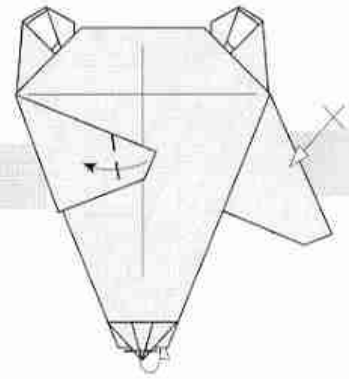
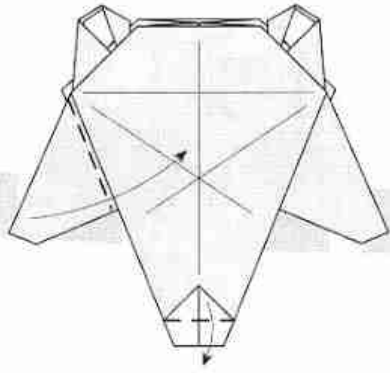
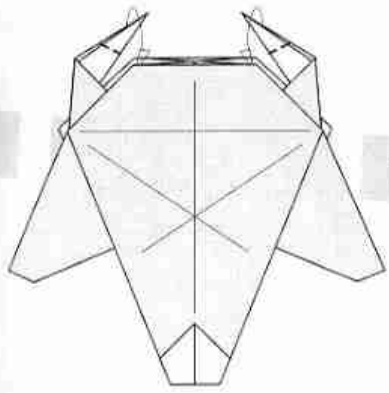

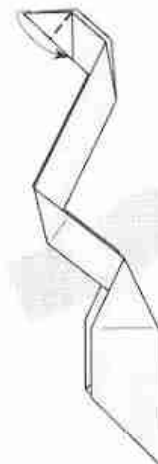
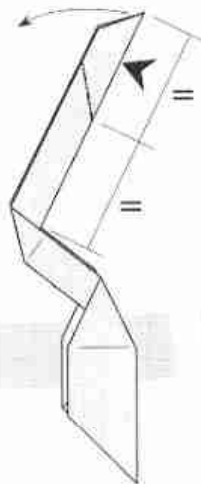
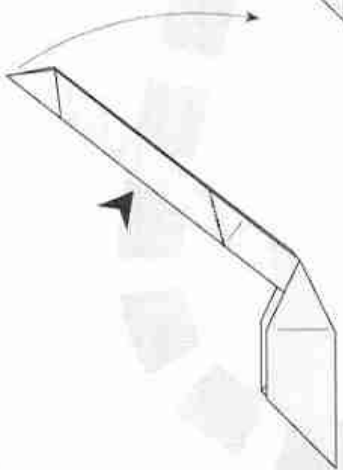
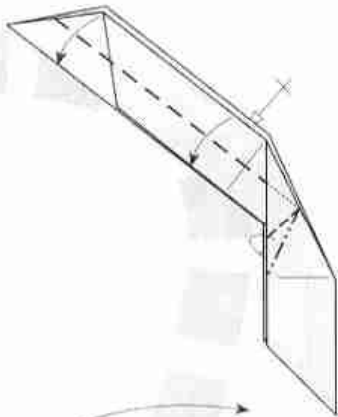
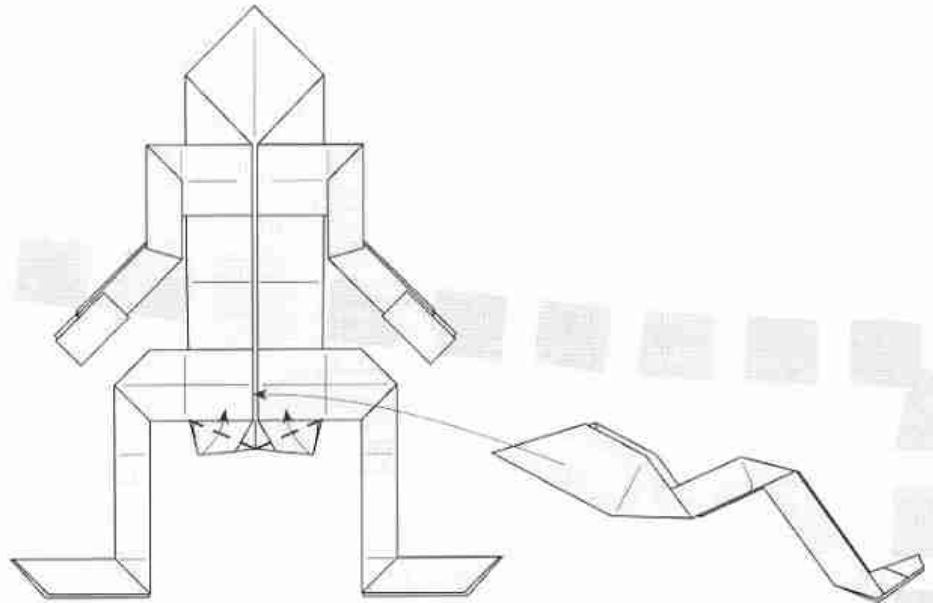
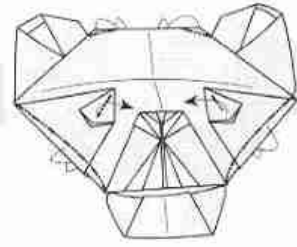
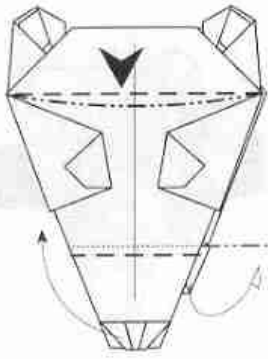

90°

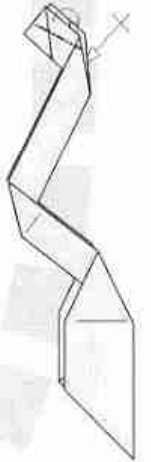

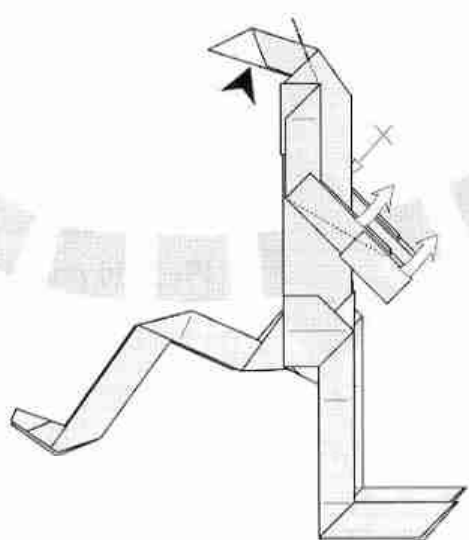
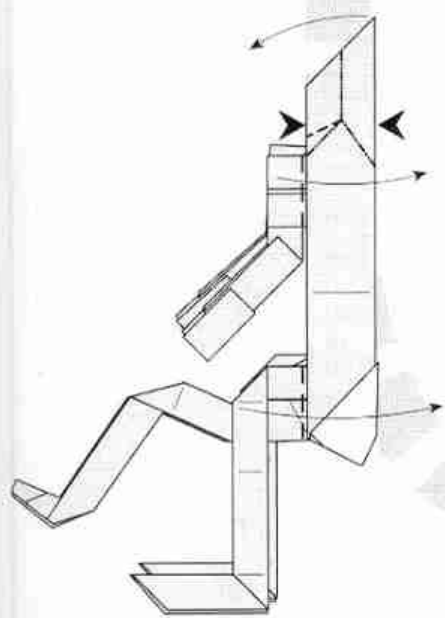
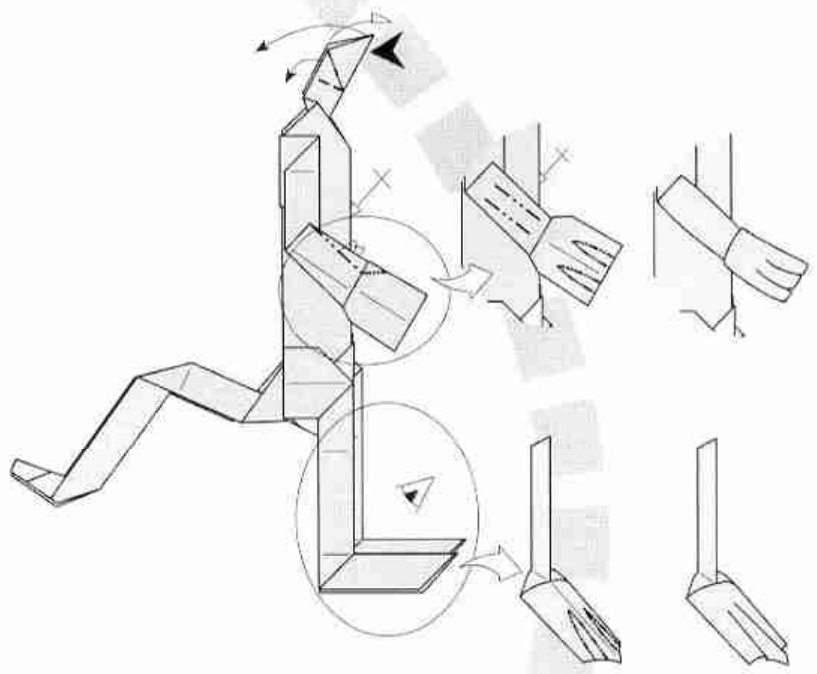
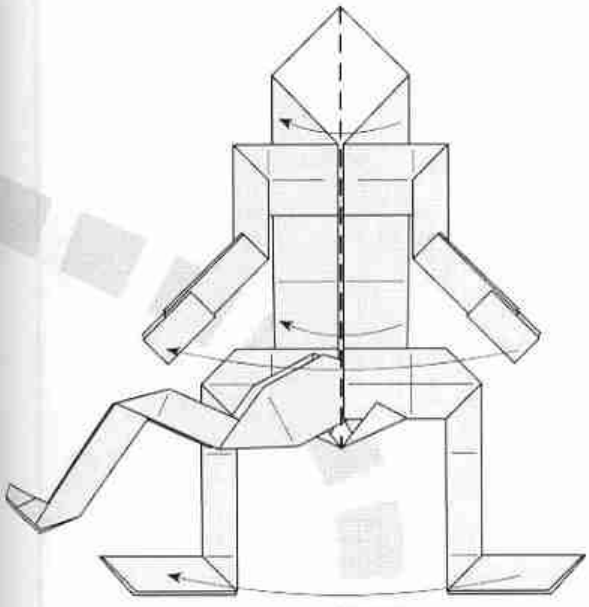
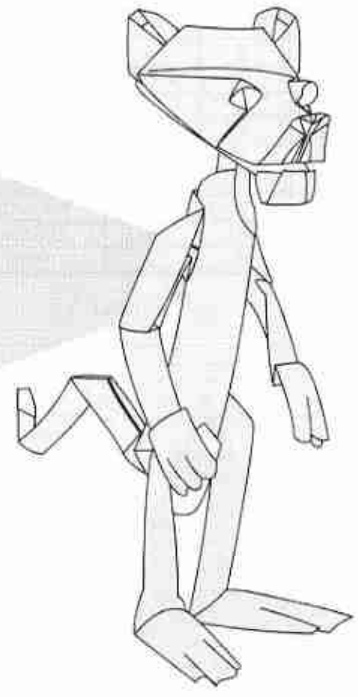
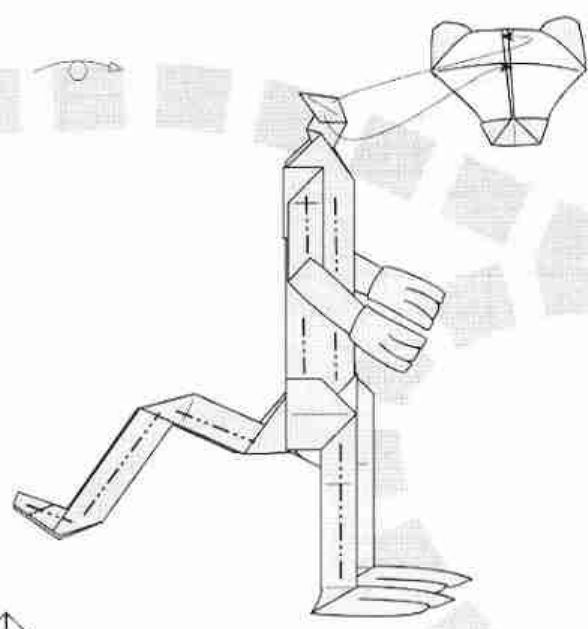
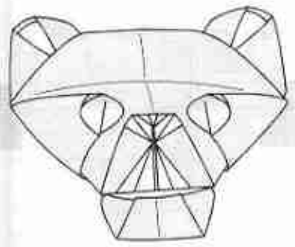

Página (Desarr.)	Pieza n°	Cantidad	Porción	COLORES		Tamaño original	Tamaño 3/10	Tamaño 2/5	Tamaño 3/5
				Anverso	Reverso	24 cm alto	7,2 cm alto	9,6 cm alto	14,4 cm alto
						Lado (cm) =	Lado (cm) =	Lado (cm) =	Lado (cm) =
101	1	1	Orejas	Rojo	Blanco	20	6	8	12
101	2	1	Cuerpo	Neutro	Negro	20	6	8	12
102	3	1	Ojos	Negro	Blanco	10	3	4	6
103	4	1	Cola	Blanco	Negro	30	9	12	18
104	5	1	Pelo	Neutro	Blanco	7,5	2,25	3	4,5
104	6	1	Cuerpo	Blanco	Negro	30	9	12	18
105	7	1	Naricilla	Neutro	Negro	7,5	2,25	3	4,5
105	8	1	Brazos	Neutro	Negro	15	4,5	6	9
106	9	2	Pies	Neutro	Negro	15	4,5	6	9

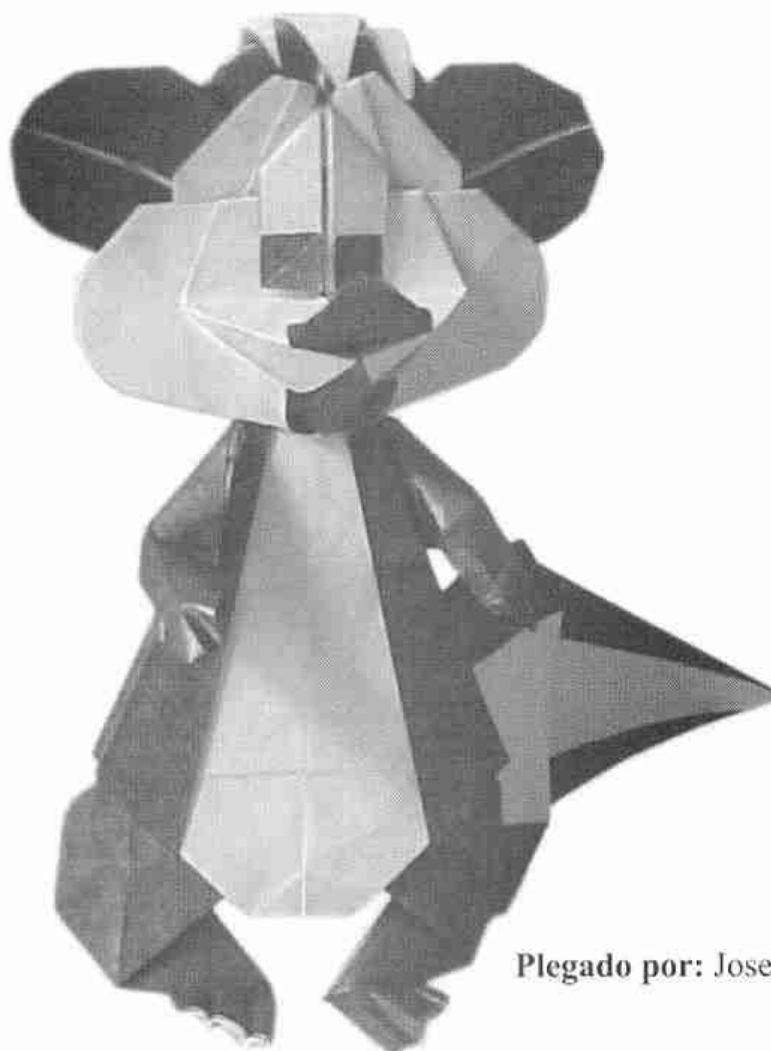

Plegado por: Jose R. Quintana Delgado

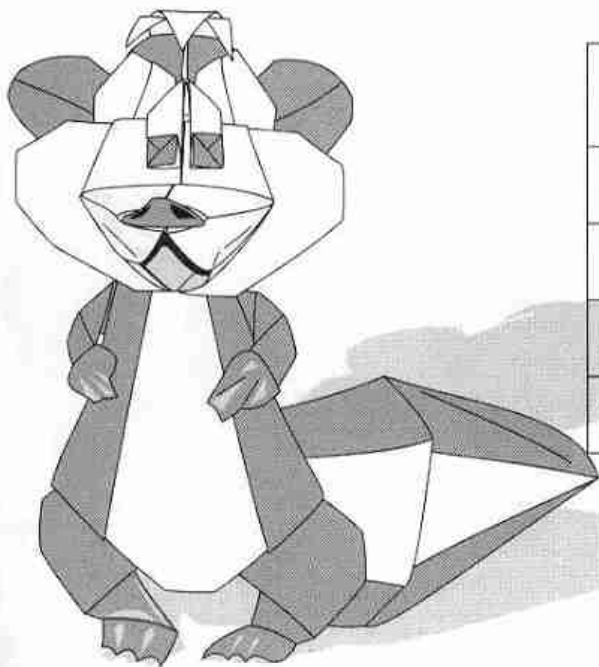

Utilizando las medidas recomendadas, se obtiene un modelo final de 24 cms.

Autor:	Halle
Nivel de dificultad:	Medio-Alto
Número de piezas:	10
Forma de las piezas:	Cuadrados

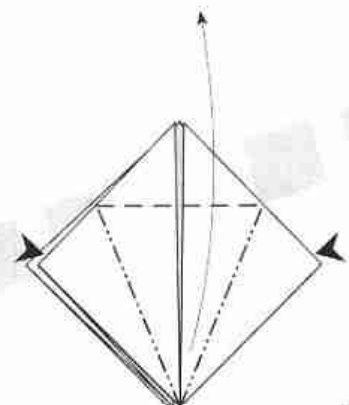
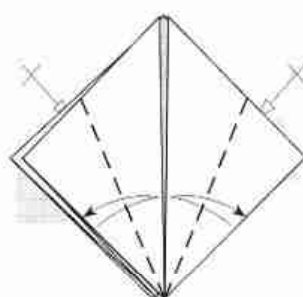
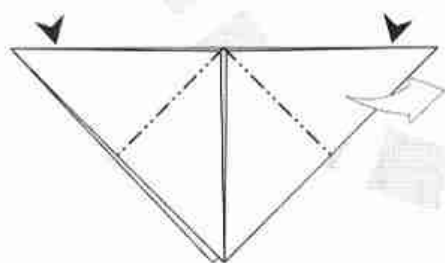
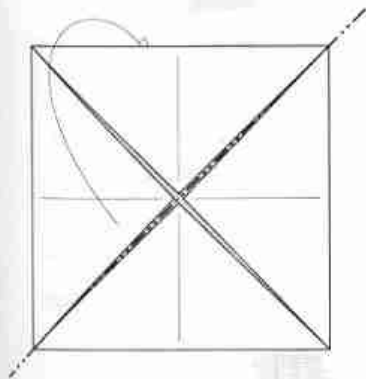
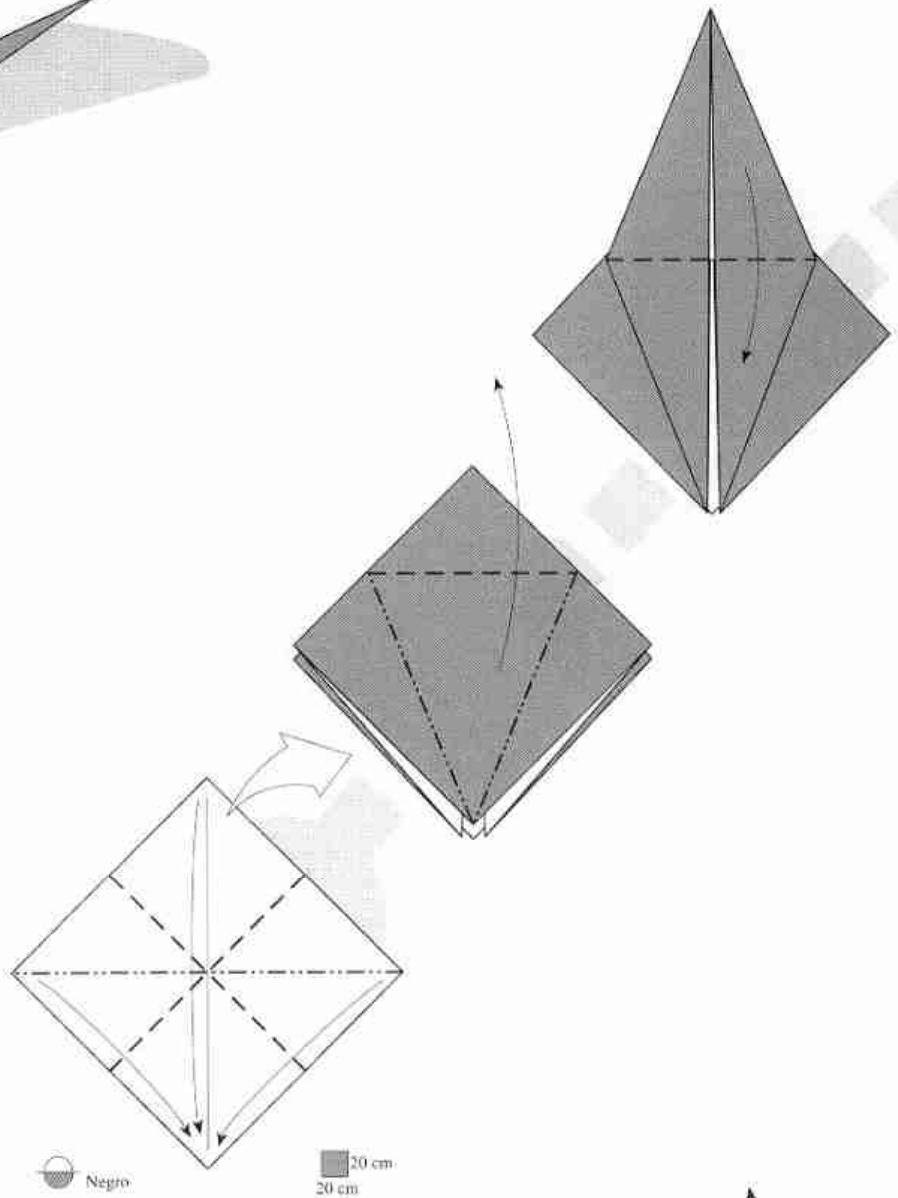
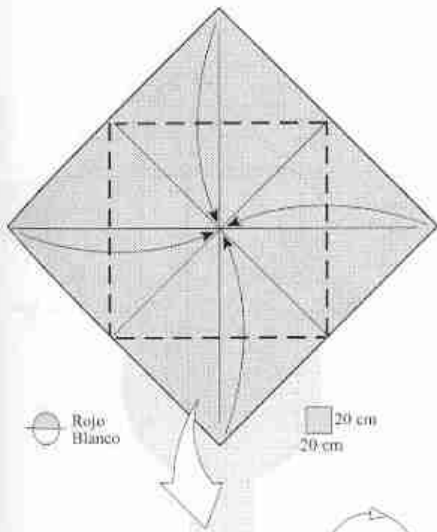

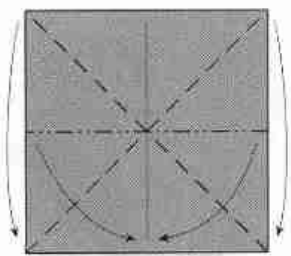
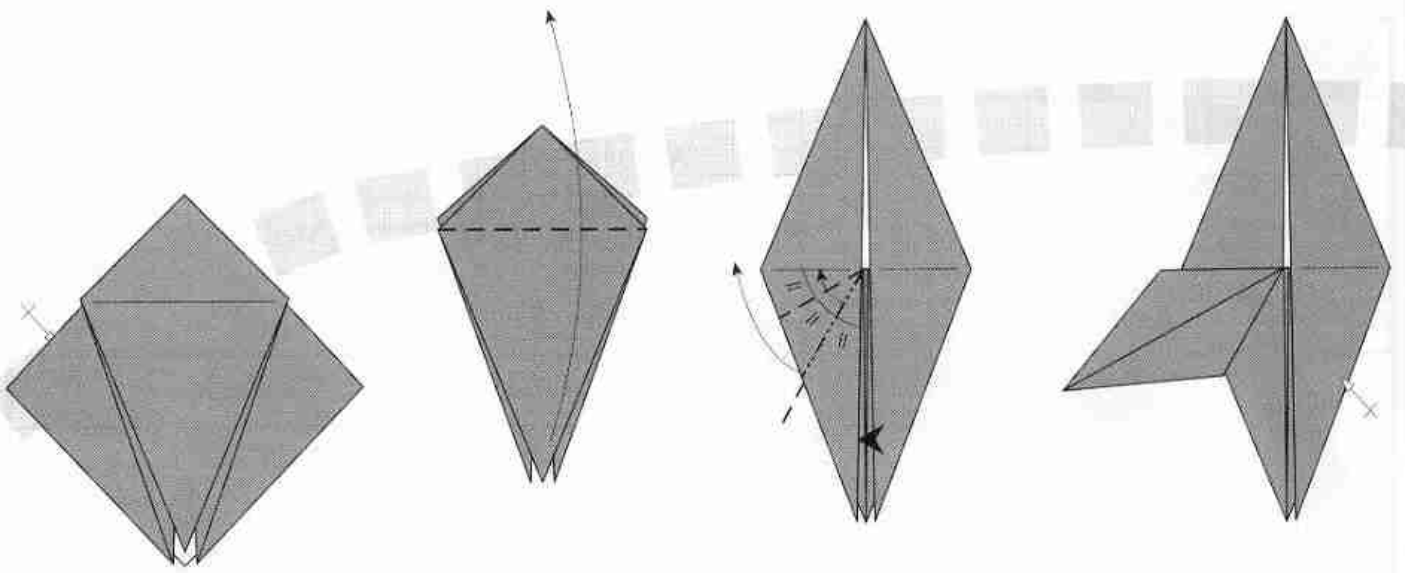

● Negro
○ Blanco

■ 10 cm
□ 10 cm

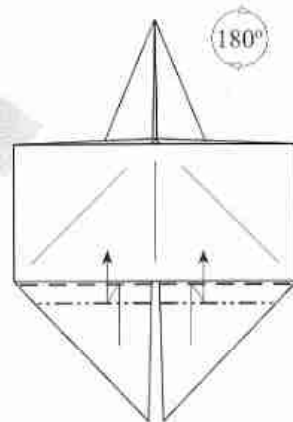
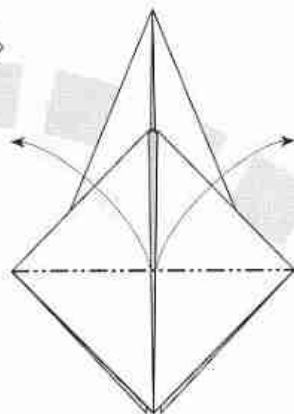
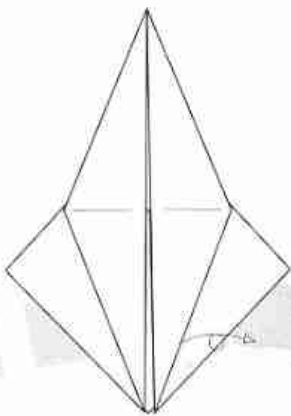
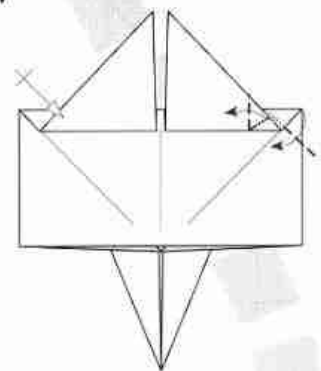
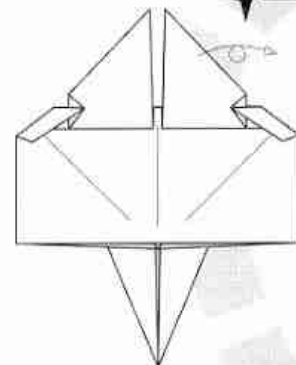
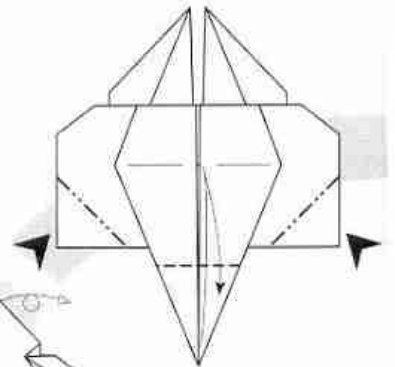
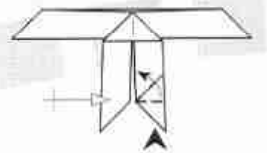
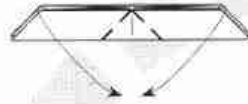
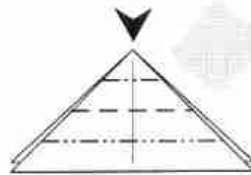
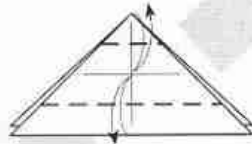
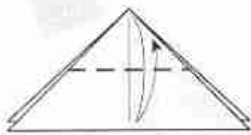

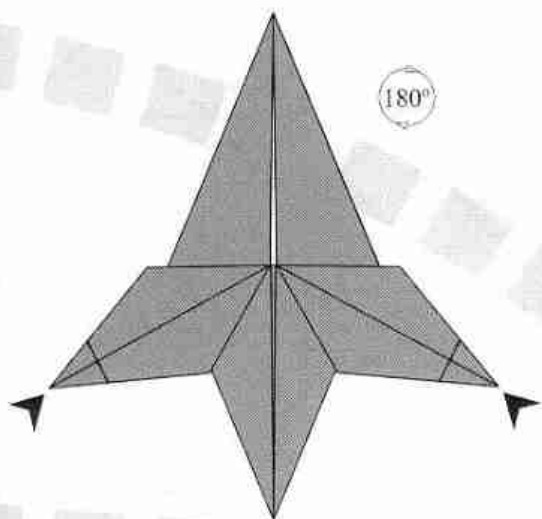

180°

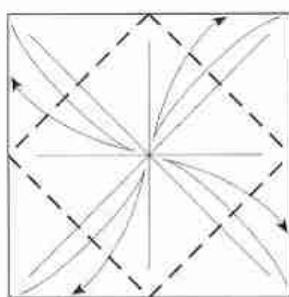
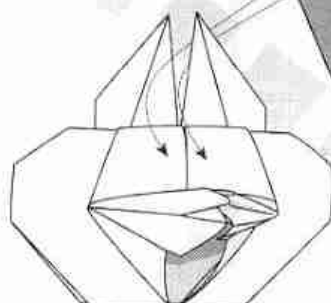
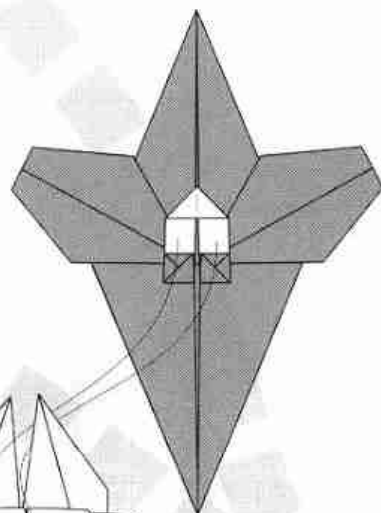
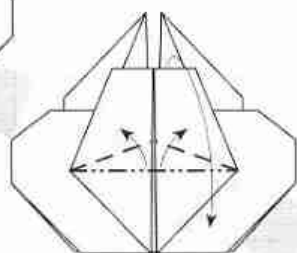
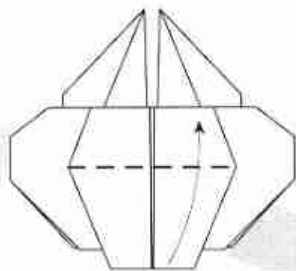
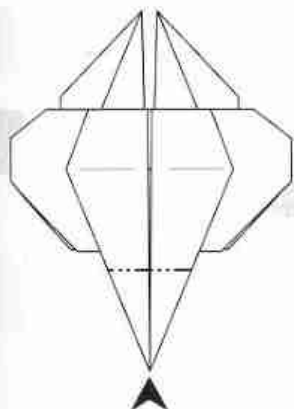
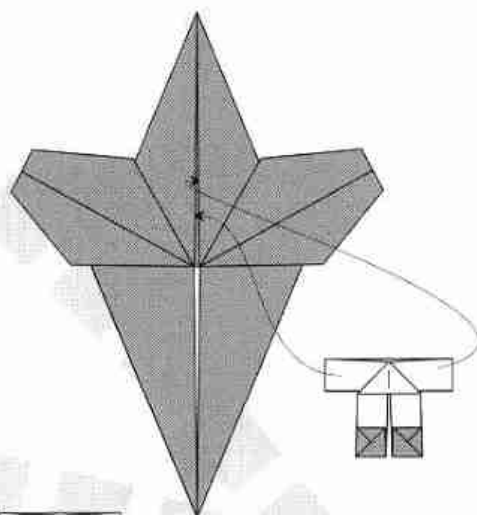

Blanco
Negro

30 cm
30 cm

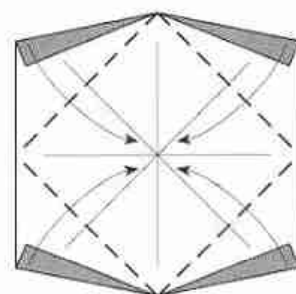
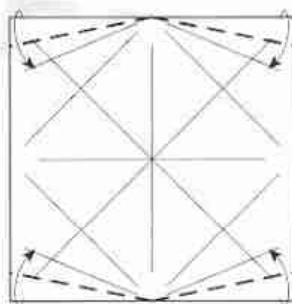
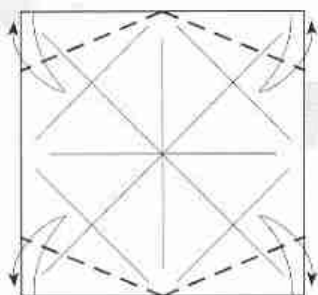

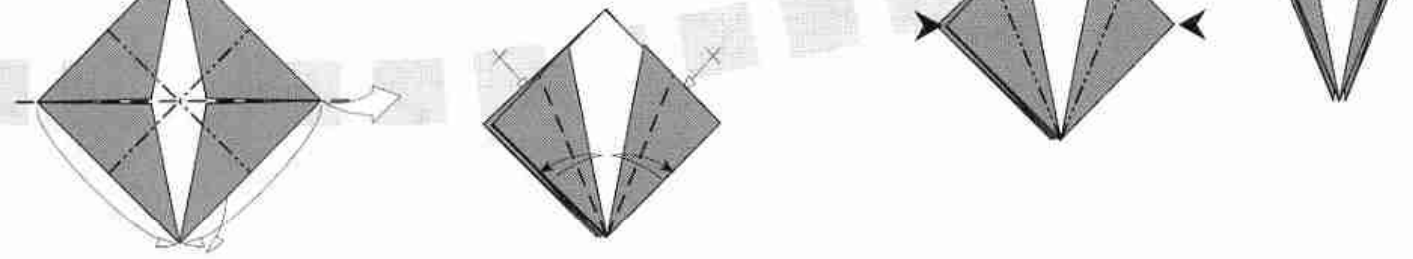
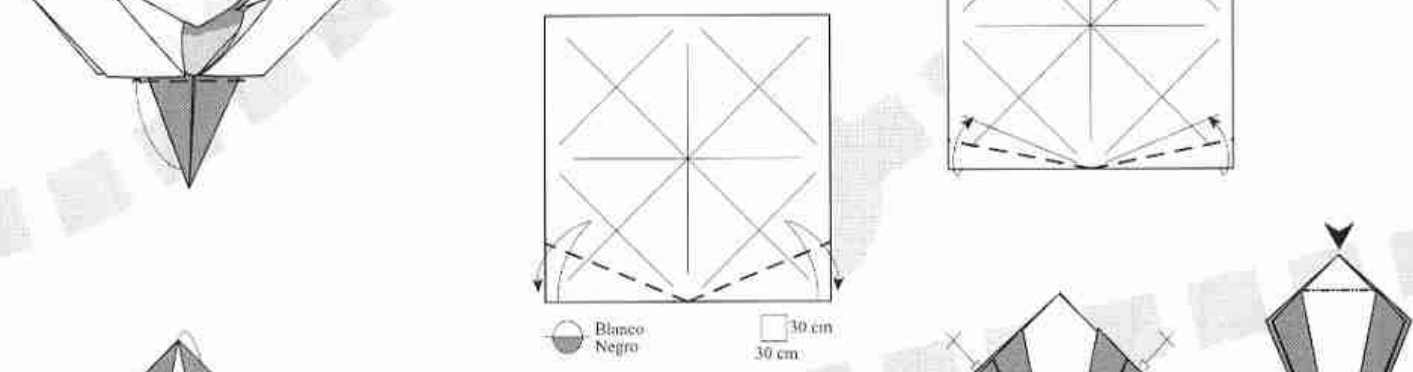
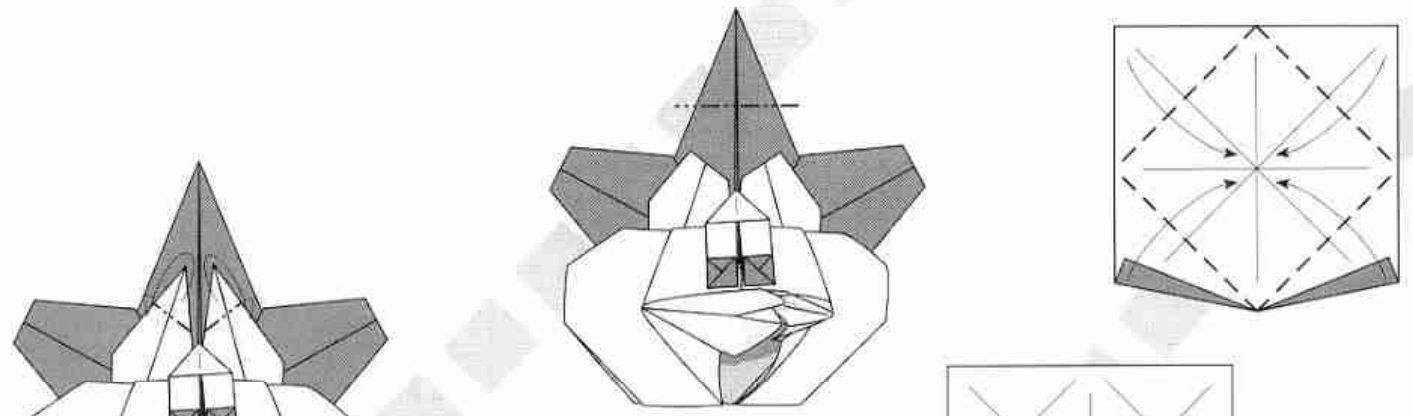
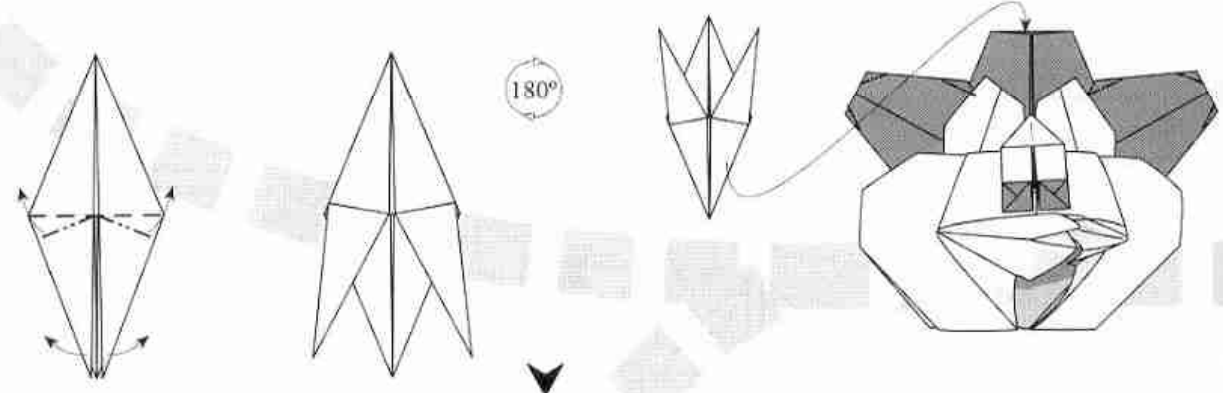
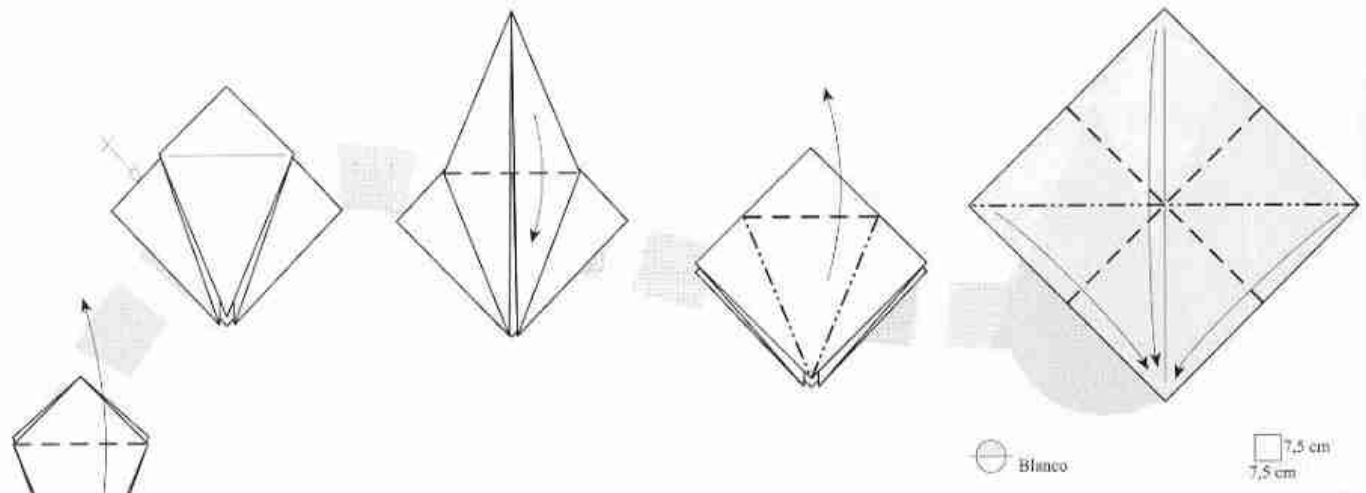

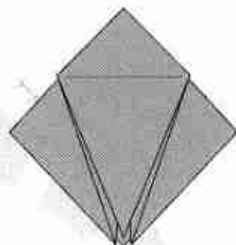
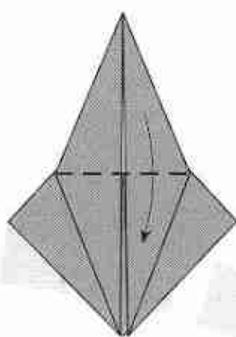
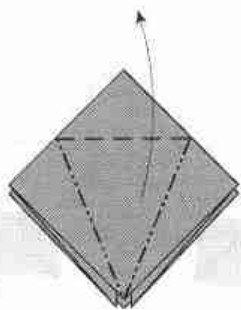
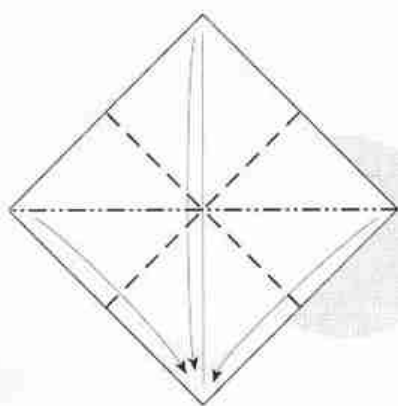

● Negro

■ 7,5 cm
7,5 cm

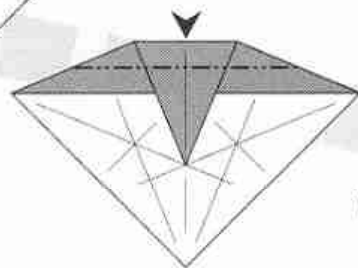
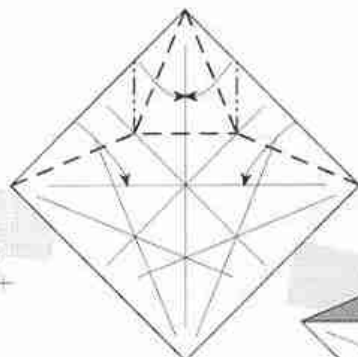
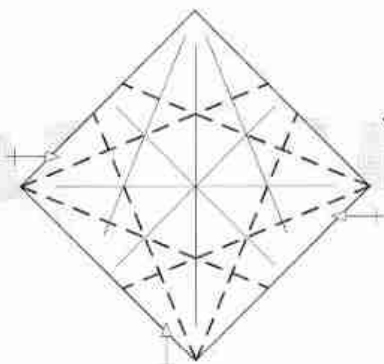
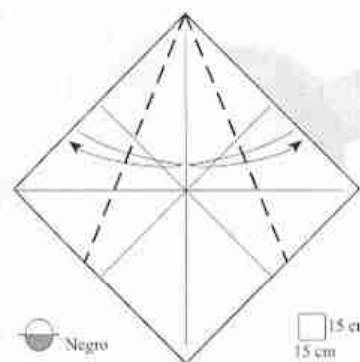
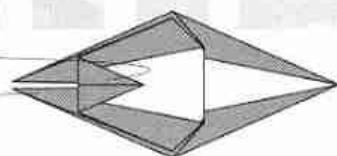
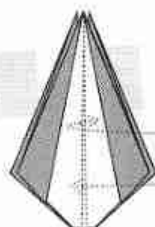
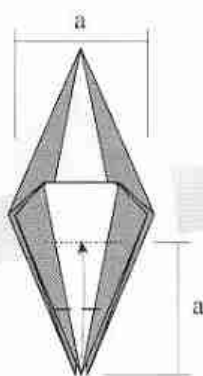
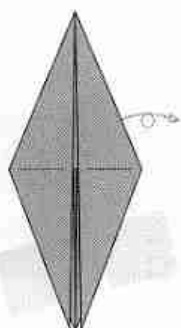
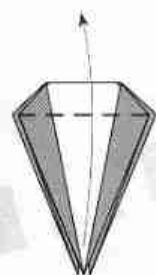
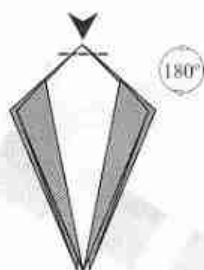
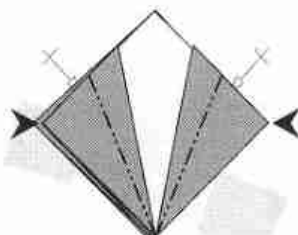
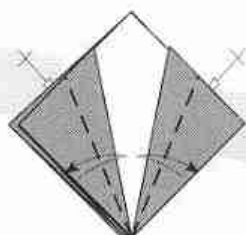
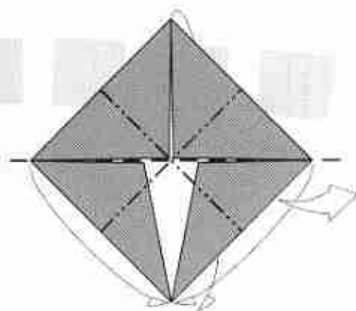
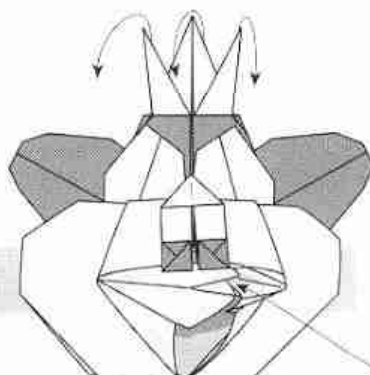
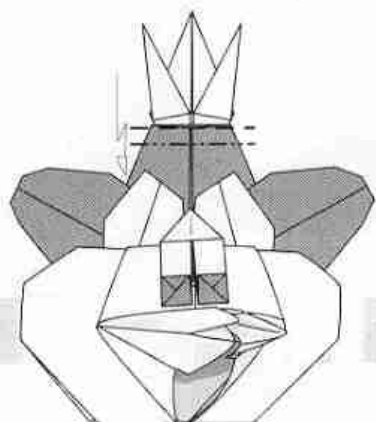

● Negro

□ 15 cm
15 cm



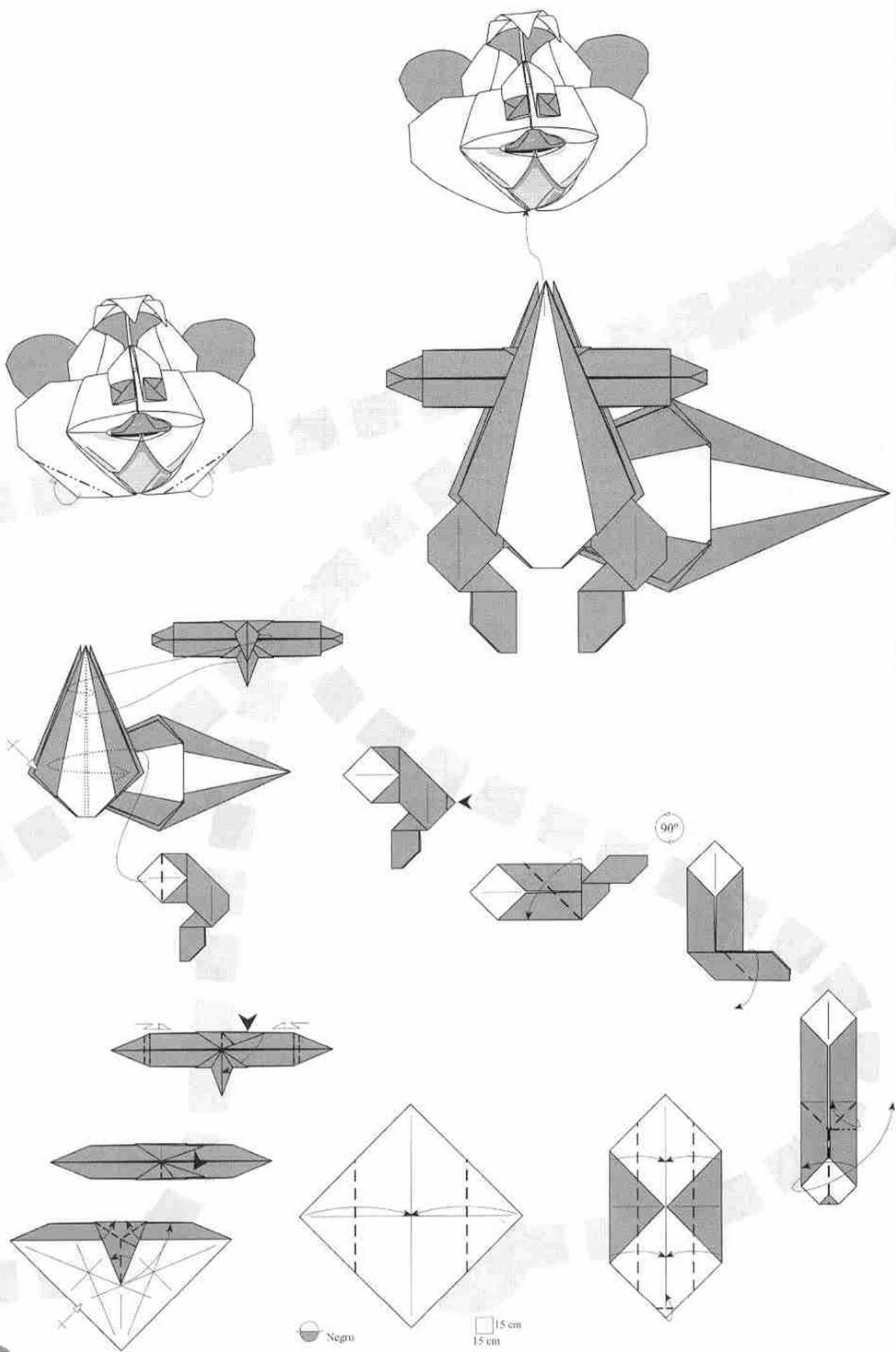

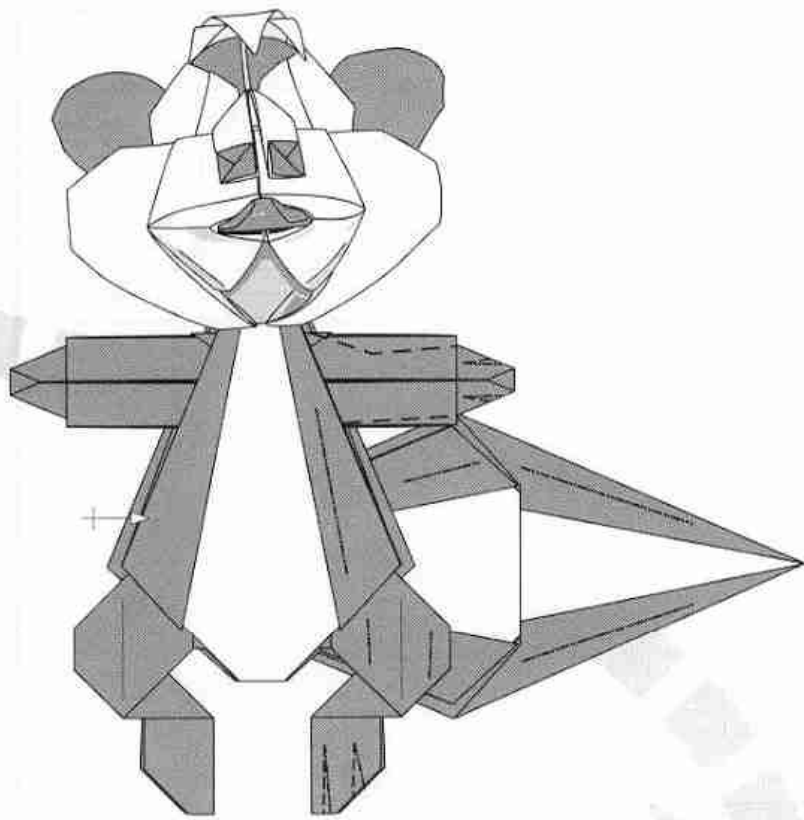

Página (Desarr.)	Pieza n°	Cantidad	Porción	COLORES		Tamaño original	Tamaño 3/10	Tamaño 2/5	Tamaño 3/5
				Anverso	Reverso	15 cm alto	4,5 cm alto	6 cm alto	9 cm alto
						Lado (cm) =	Lado (cm) =	Lado (cm) =	Lado (cm) =
109	1	1	Cuerpo	Neutro	Amarillo	20	6	8	12
110	2	1	Brazos	Neutro	Naranja	10	3	4	6
111	3	1	Alas	Neutro	Blanco	10	3	4	6
111	4	1	Cara	Naranja	Amarillo	15	4,5	6	9
112	5	4	Listas	Neutro	Negro	7,5	2,25	3	4,5
112	6	1	Antenas	Amarillo	Negro	10	3	4	6
114	7	2	Patas	Neutro	Naranja	7,5	2,25	3	4,5
115	8	1	Ojos	Negro	Blanco	5	1,5	2	3



Plegado por: Jose R. Quintana Delgado

Utilizando las medidas recomendadas, se obtiene un modelo final de 15 cms.

Autor:

Halle

Nivel de dificultad:

Medio

Número de piezas:

12

Forma de las piezas:

Cuadrados

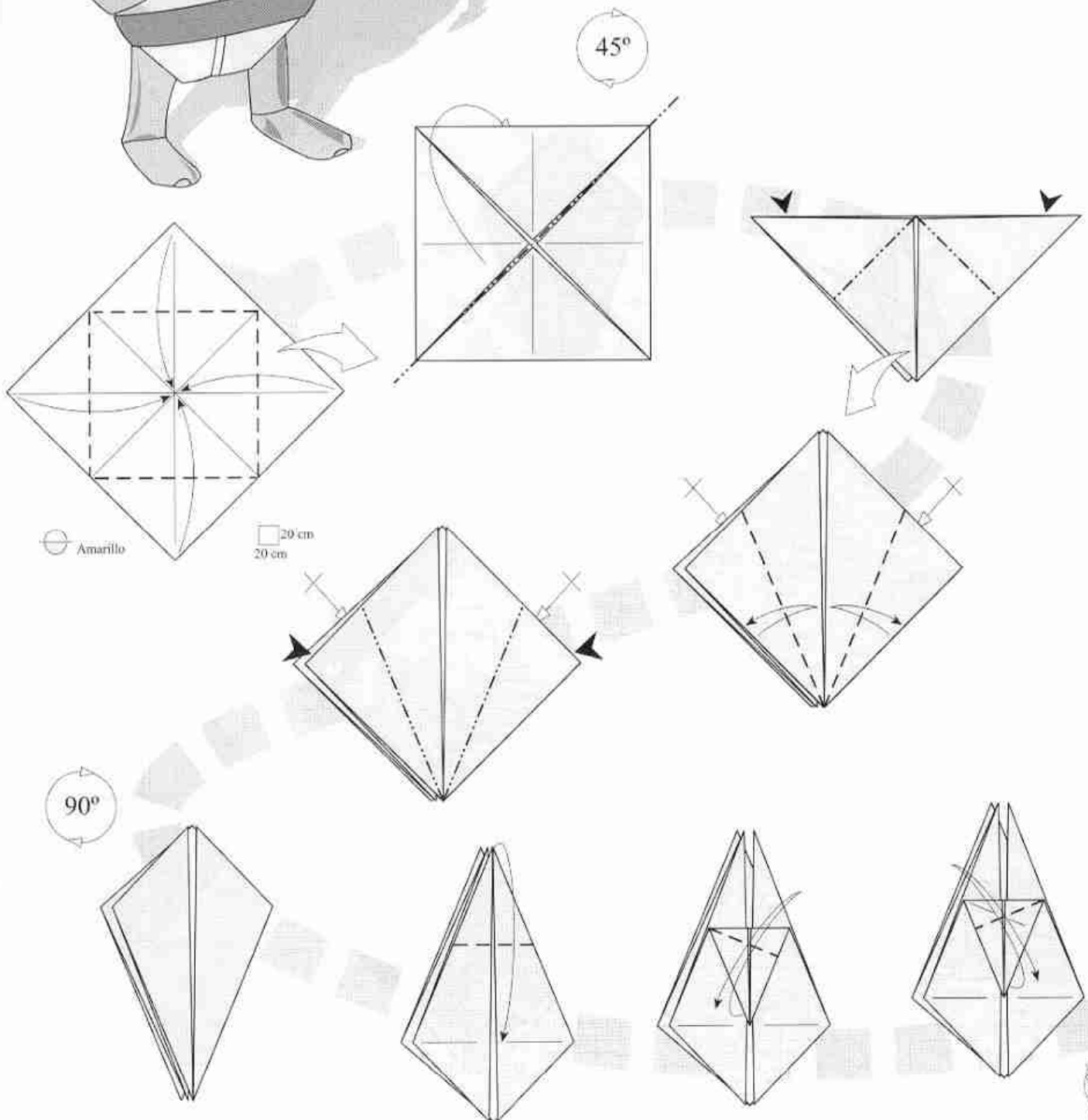

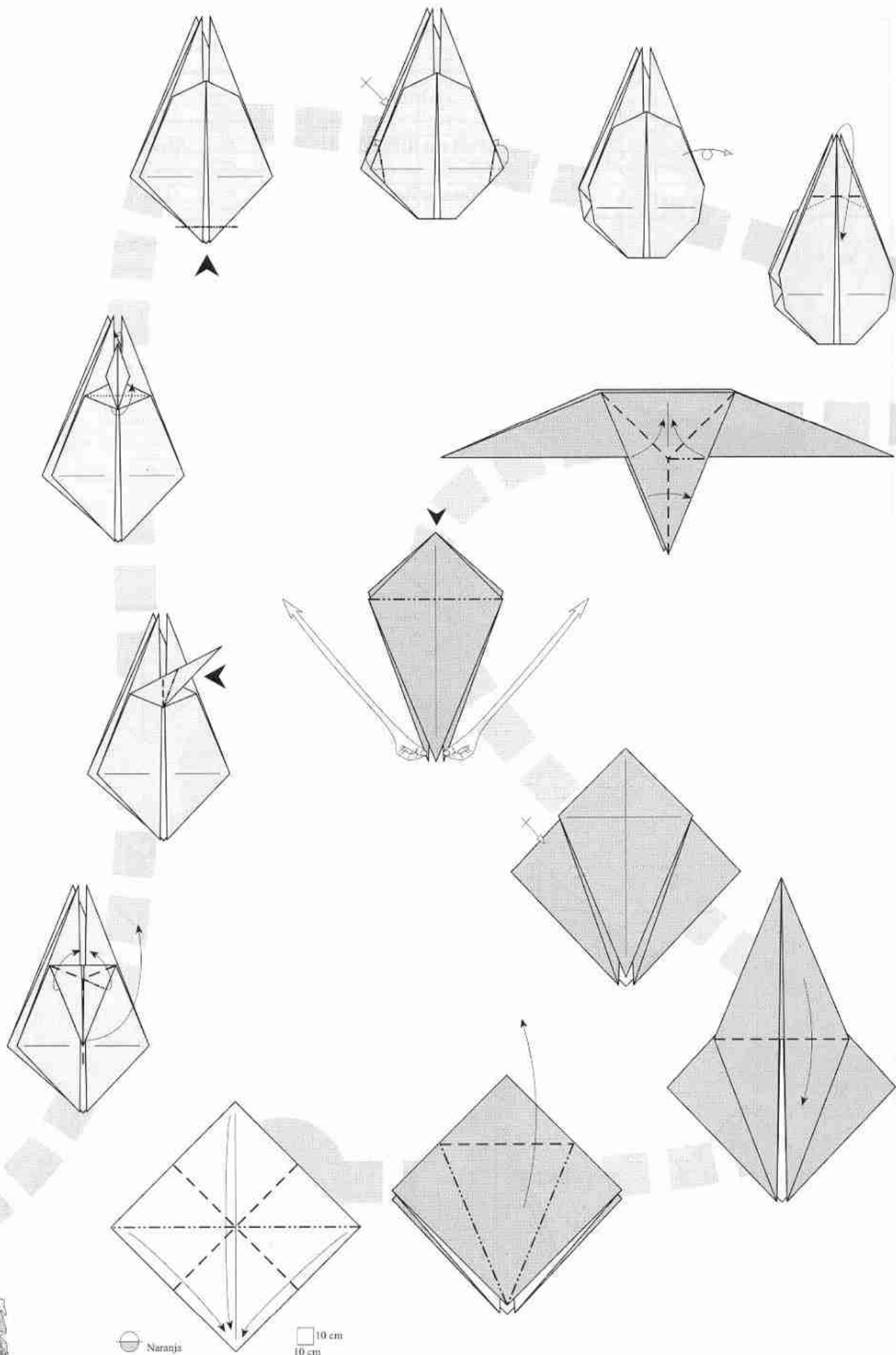

● Naranja

□ 10 cm
10 cm



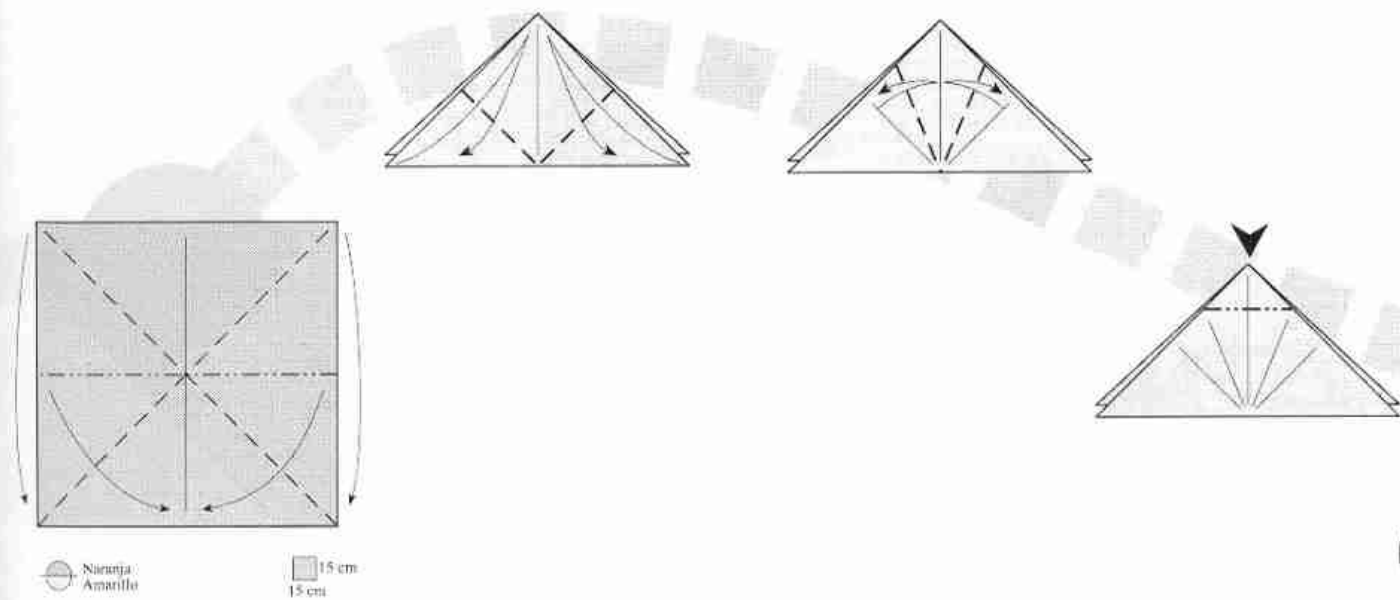
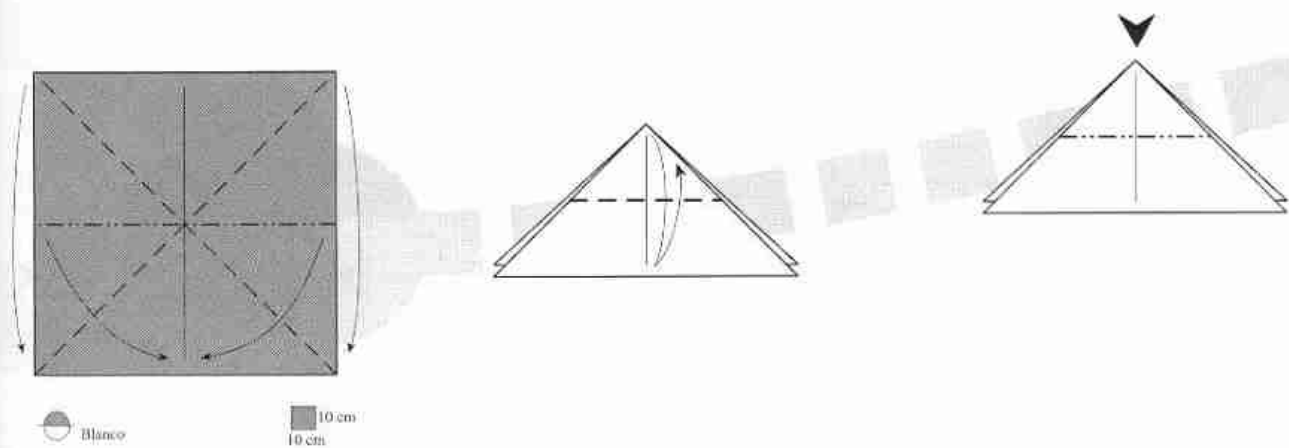
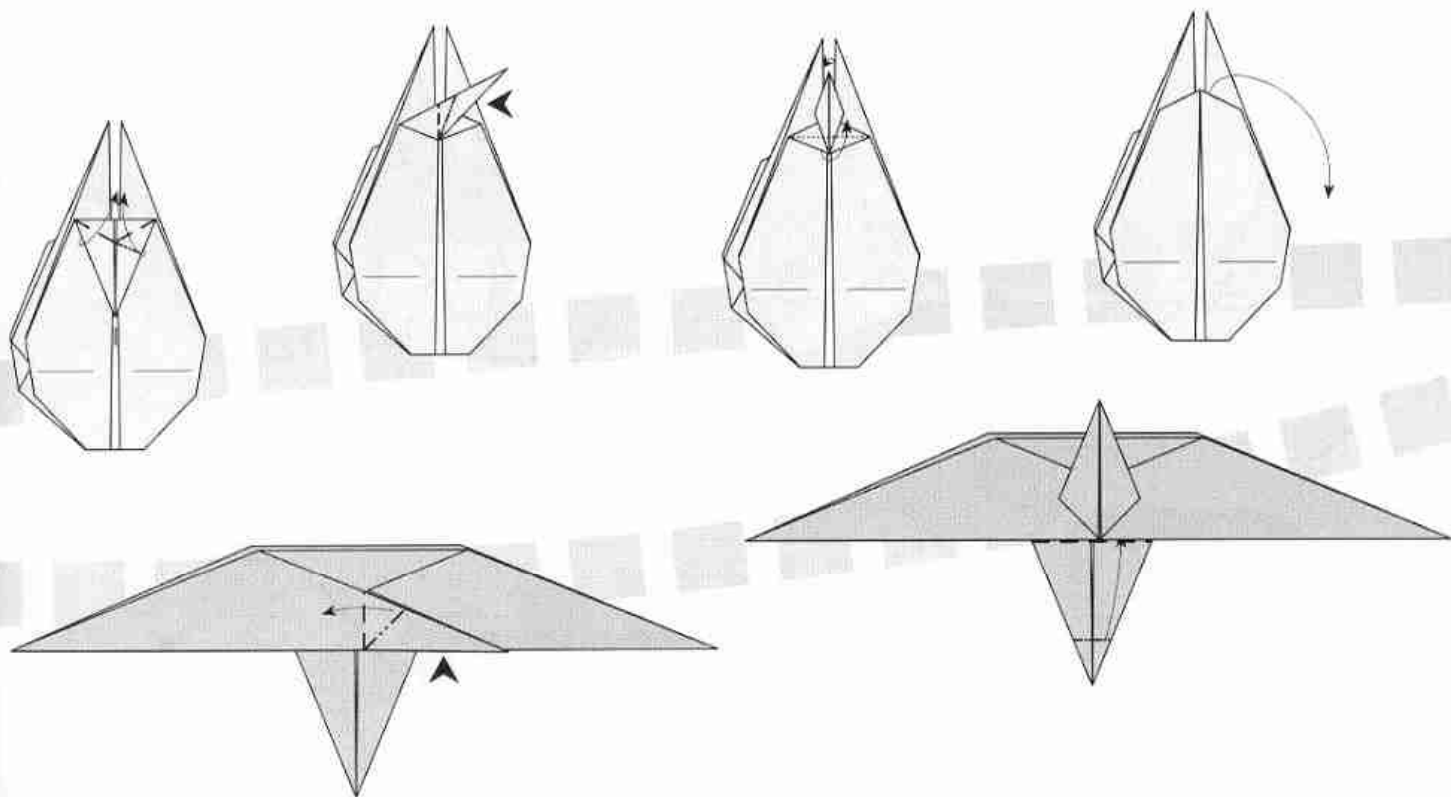

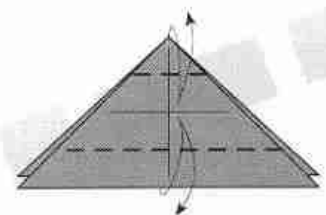
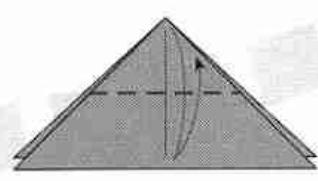
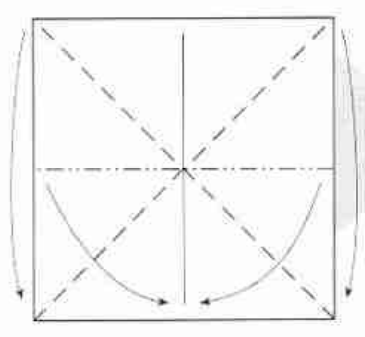
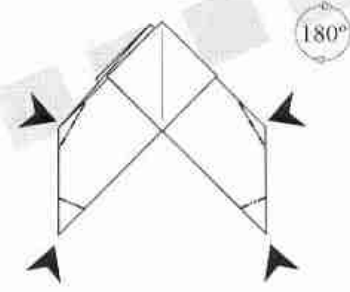
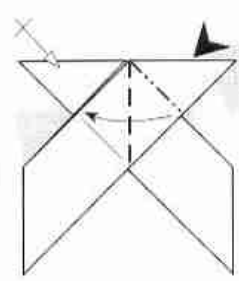
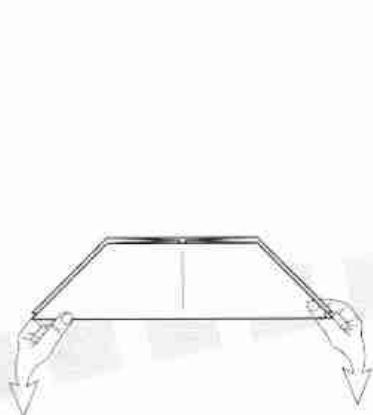
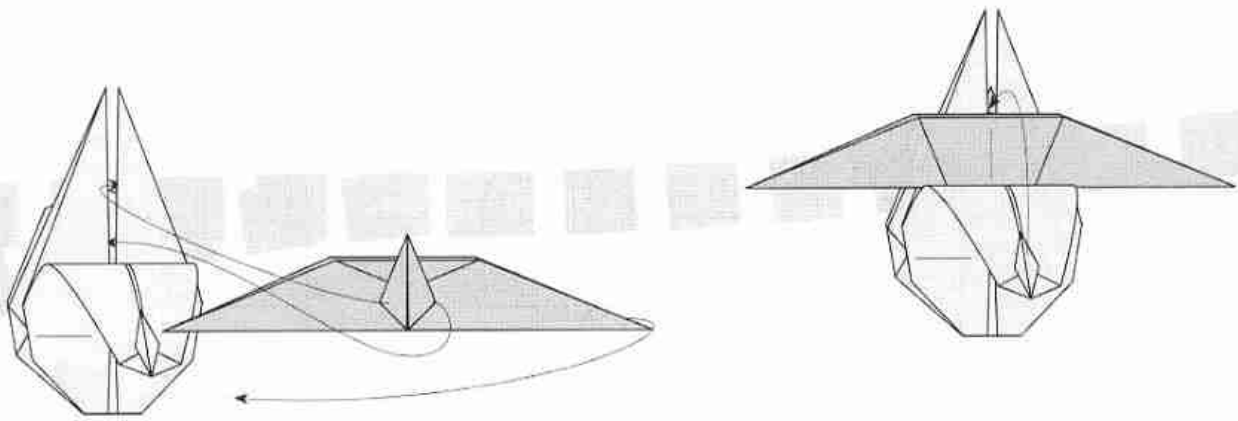

 Negro
 7,5 cm
 7,5 cm

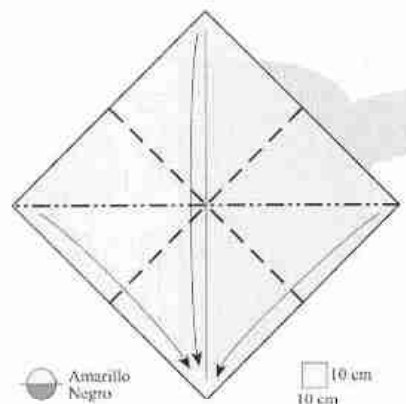
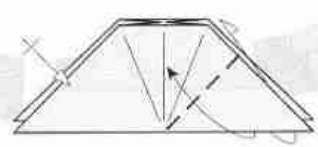
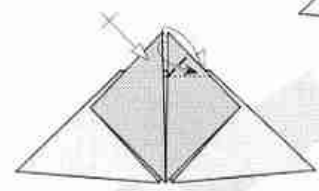
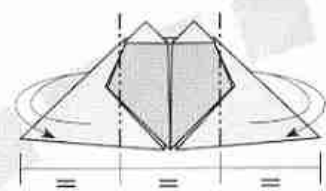
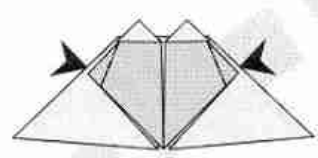

 Amacillo Negro
 10 cm
 10 cm



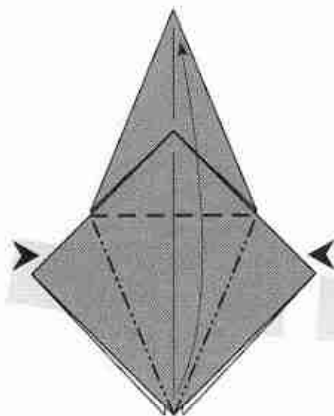
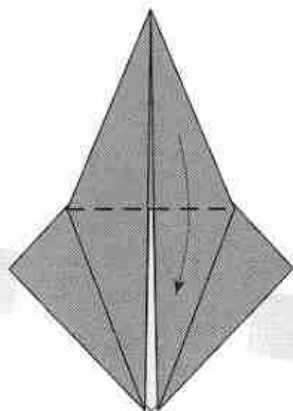
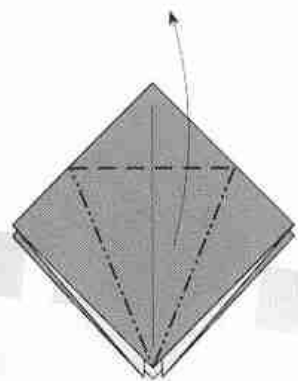
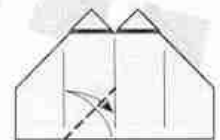
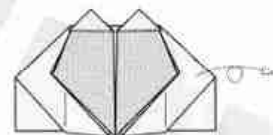
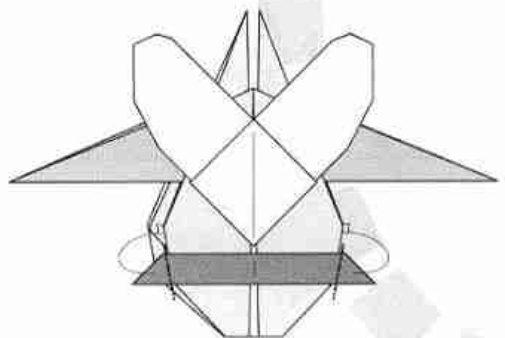
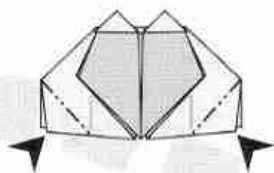
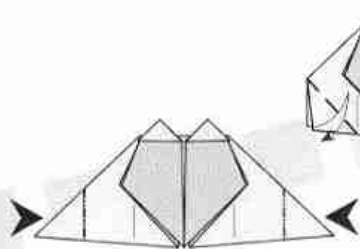
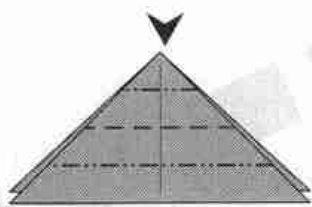
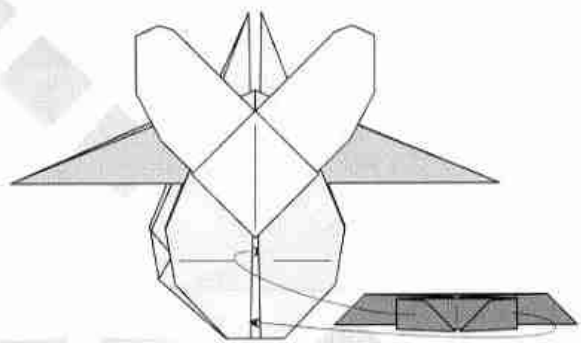
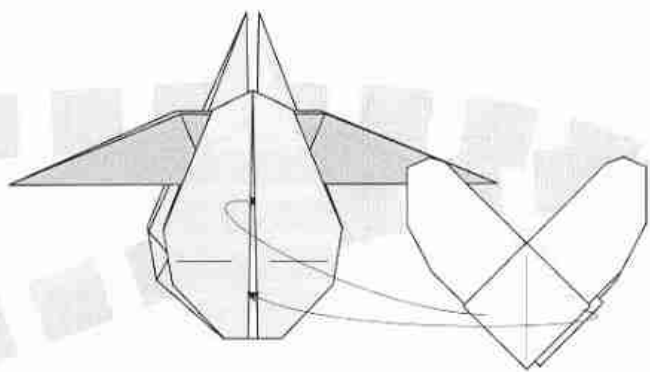

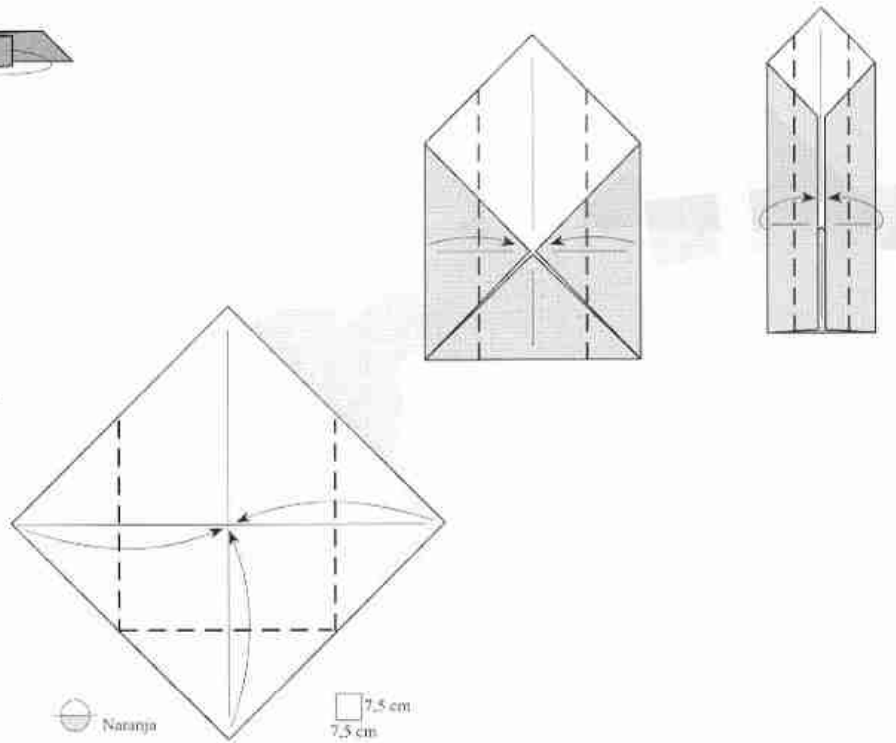
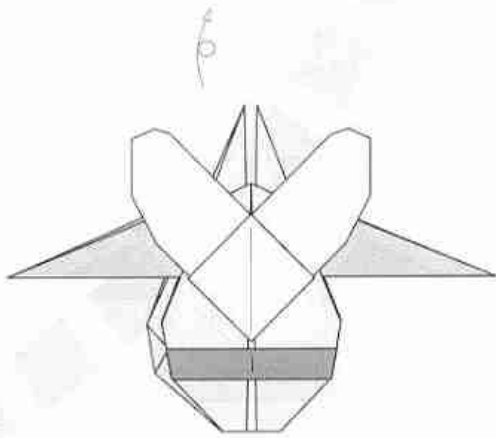
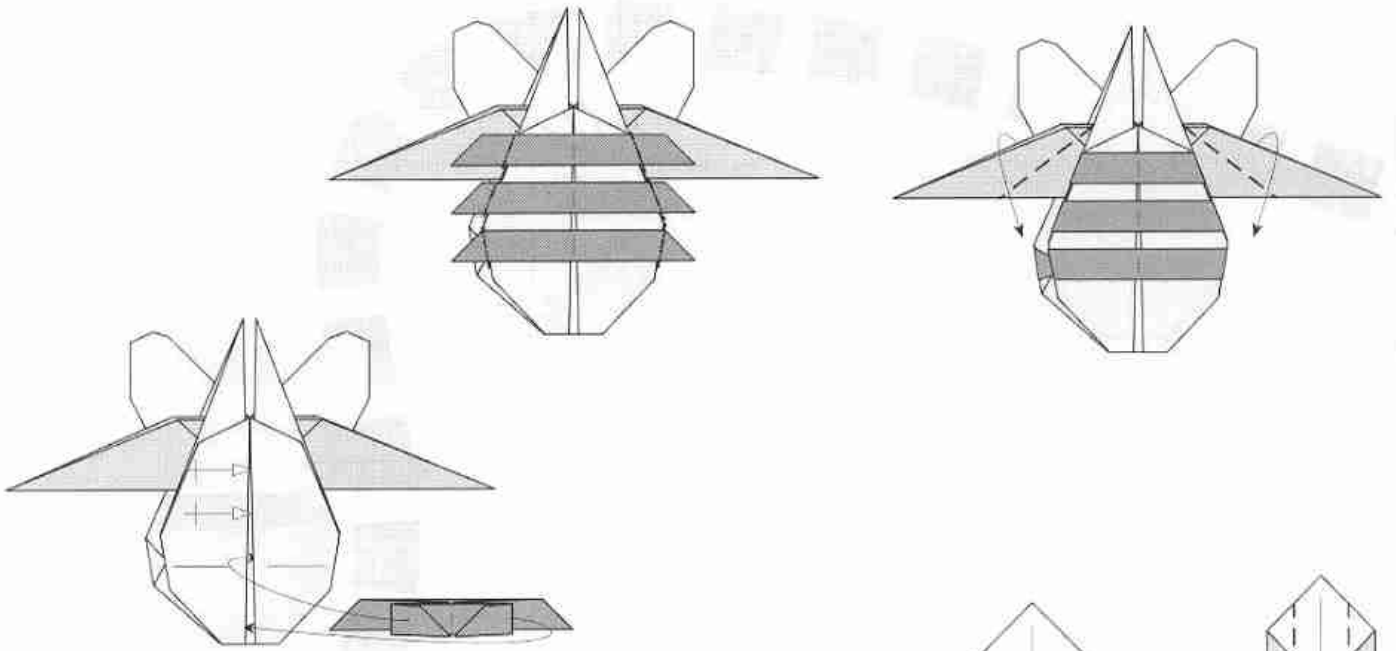

○ Naranja □ 7,5 cm
7,5 cm

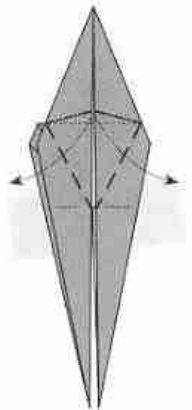
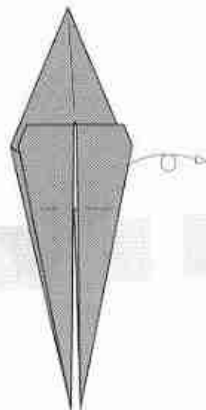
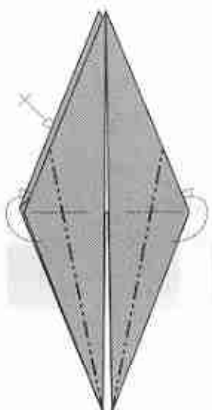
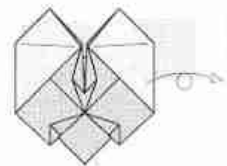
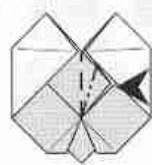
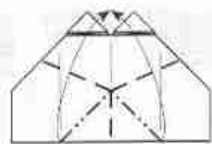
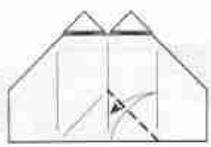

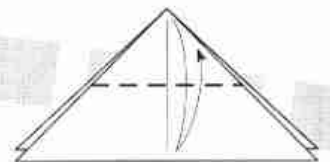
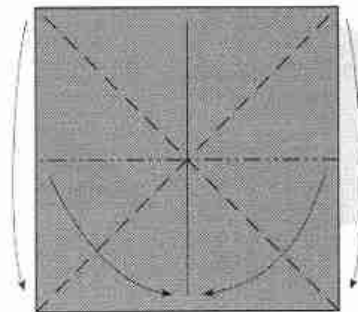
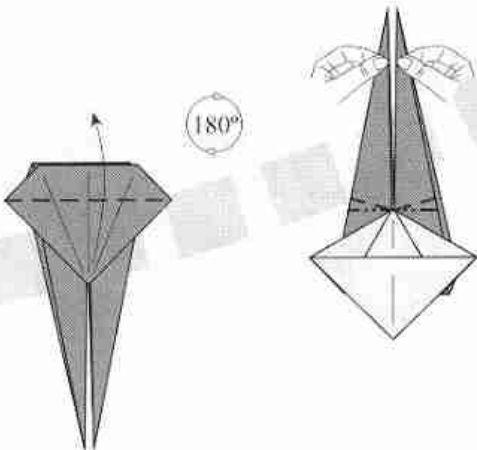
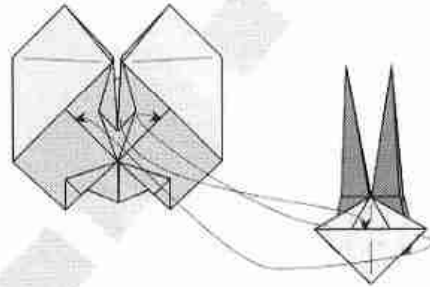
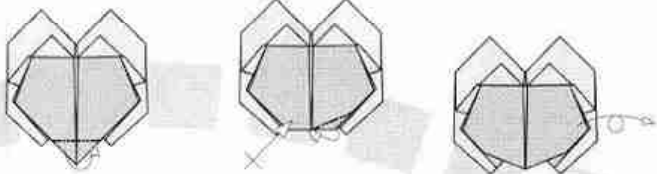
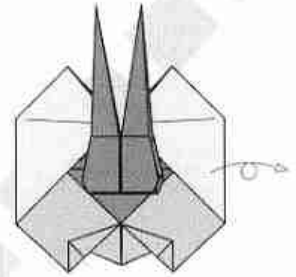
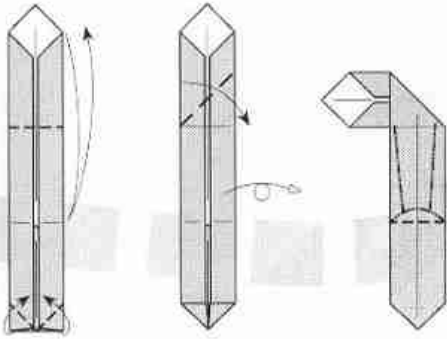
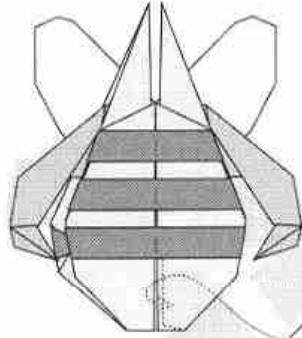
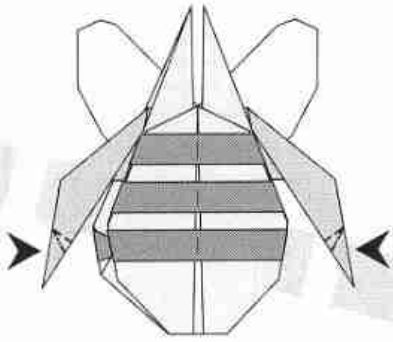

● Negro
○ Blanco

■ 5 cm
□ 5 cm



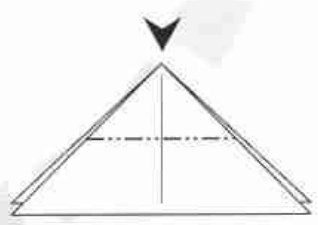
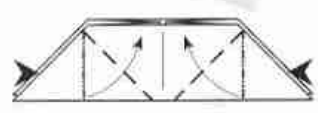
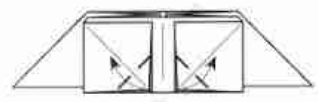
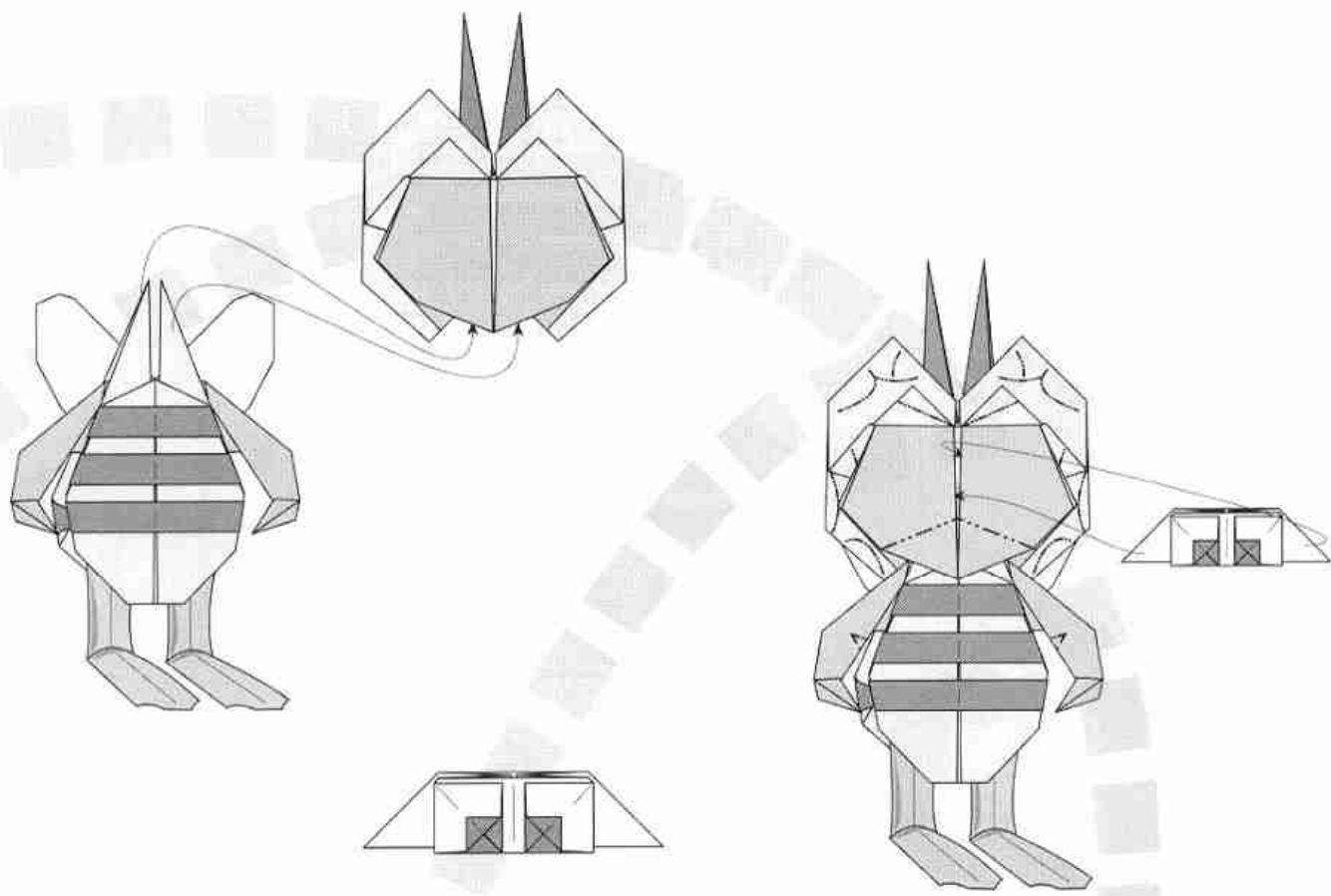

Página (Desarr.)	Pieza nº	Cantidad	Porción	COLORES		Tamaño original	Tamaño 3/10	Tamaño 2/5	Tamaño 3/5
				Anverso	Reverso	18 cm alto	5,4 cm alto	7,2 cm alto	10,8 cm alto
						Lado (cm) =	Lado (cm) =	Lado (cm) =	Lado (cm) =
118	1	1	Cuerpo	Rojo	Marrón	20	6	8	12
118	2	1	Piernas	Marrón	Rojo	15	4,5	6	9
118	3	1	Brazos	Marrón	Naranja	15	4,5	6	9
119	4	1	Orejas	Naranja	Marrón	5	1,5	2	3
123	5	2	Tirantes	Neutro	Verde	5	1,5	2	3
123	6	1	Corbata	Neutro	Azul	3,75	1,125	1,5	2,25
125	7	1	Gorro	Neutro	Azul	5	1,5	2	3
125	8	1	Ojos	Negro	Bianco	3,75	1,125	1,5	2,25

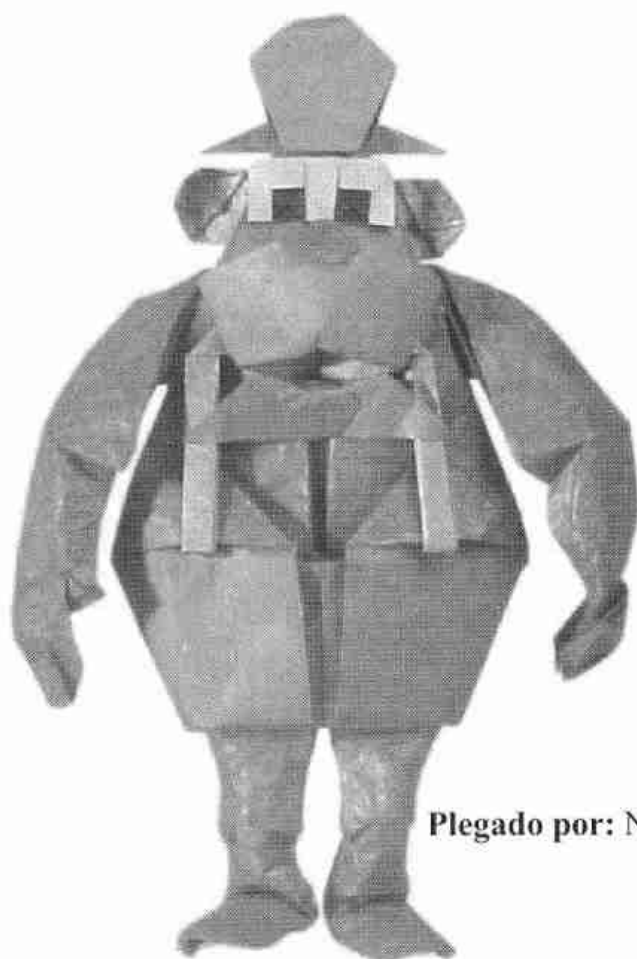

Plegado por: Nicolas Terry

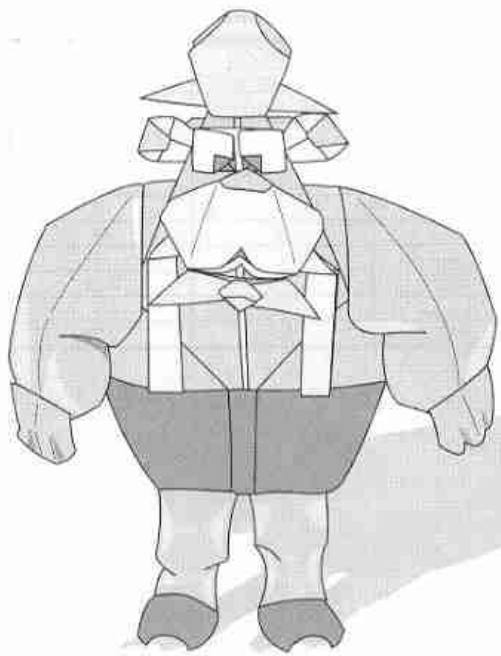

Utilizando las medidas recomendadas, se obtiene un modelo final de 18 cms.

Autor:	Halle
Nivel de dificultad:	Medio-Alto
Número de piezas:	9
Forma de las piezas:	Cuadrados

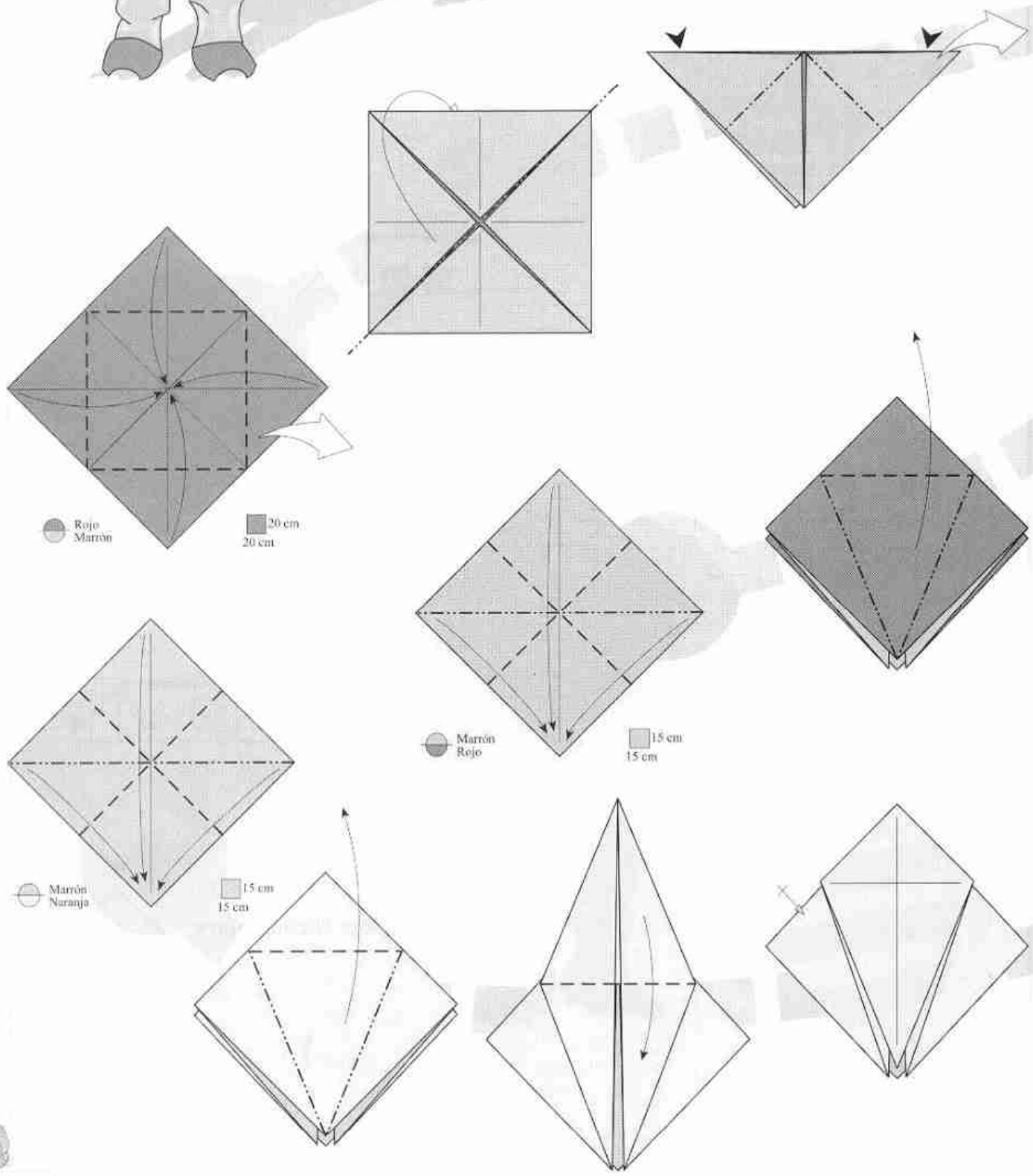

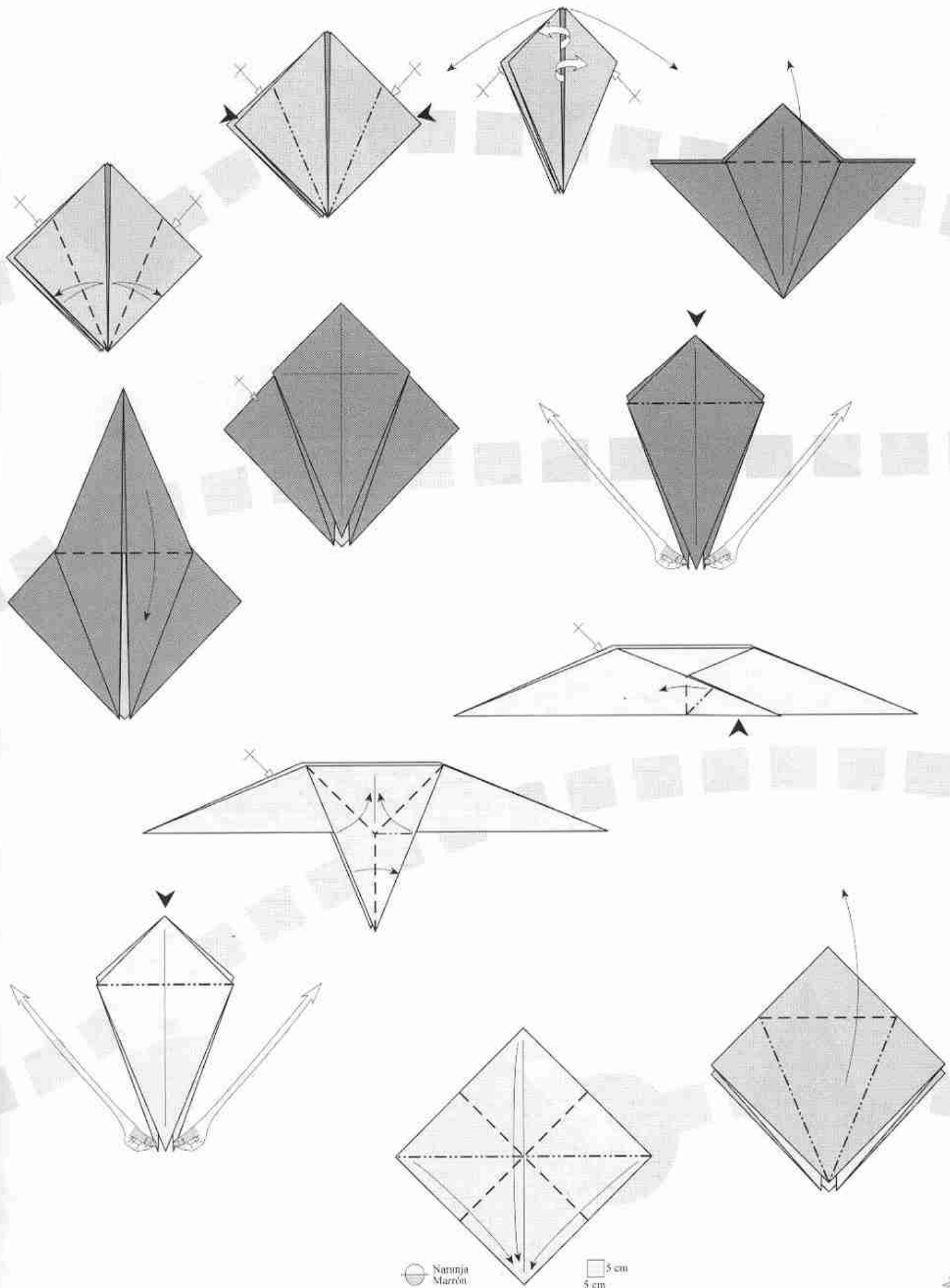

Naranja
 Marrón

5 cm
 5 cm



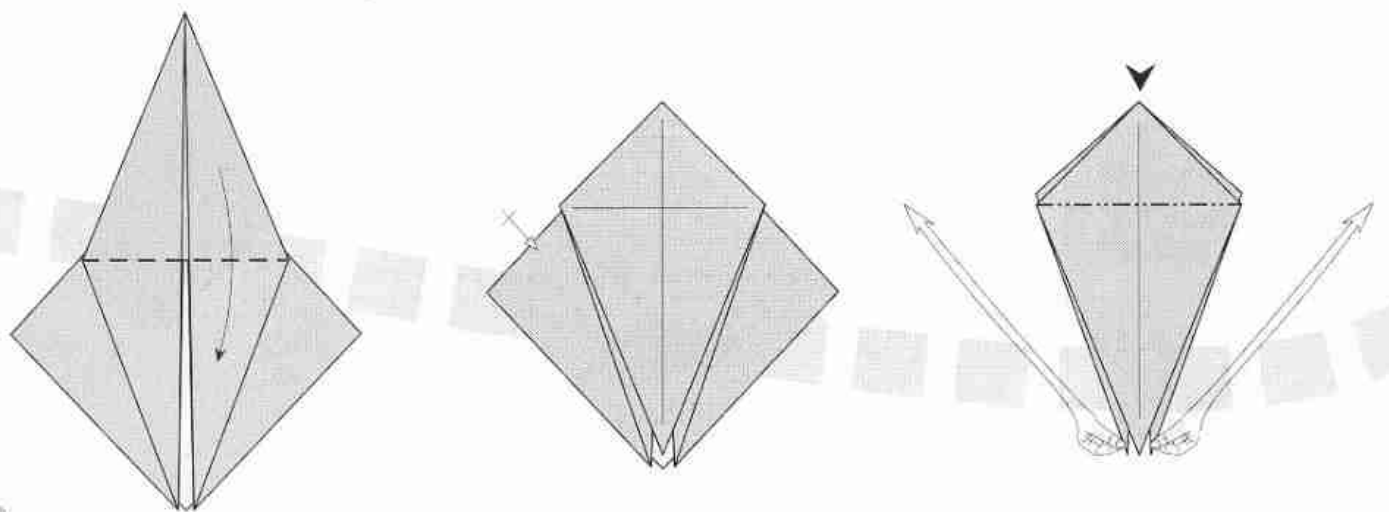
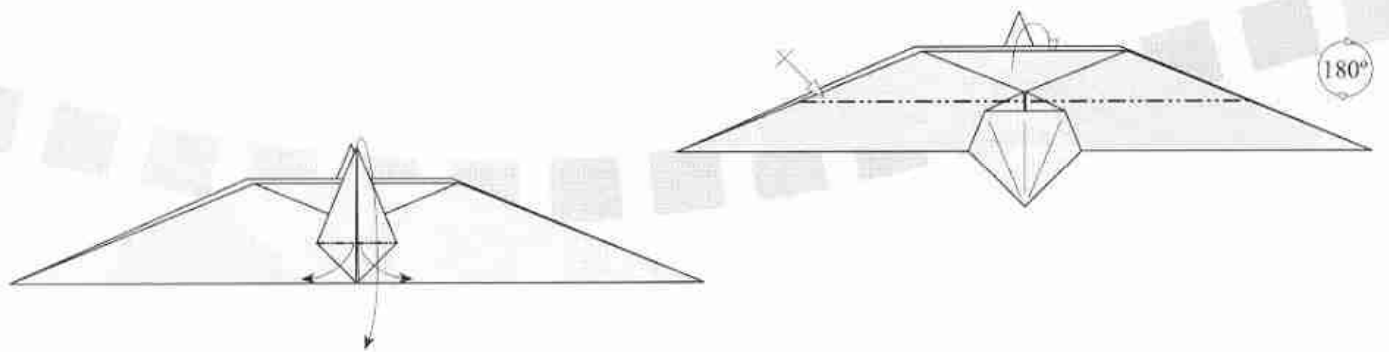
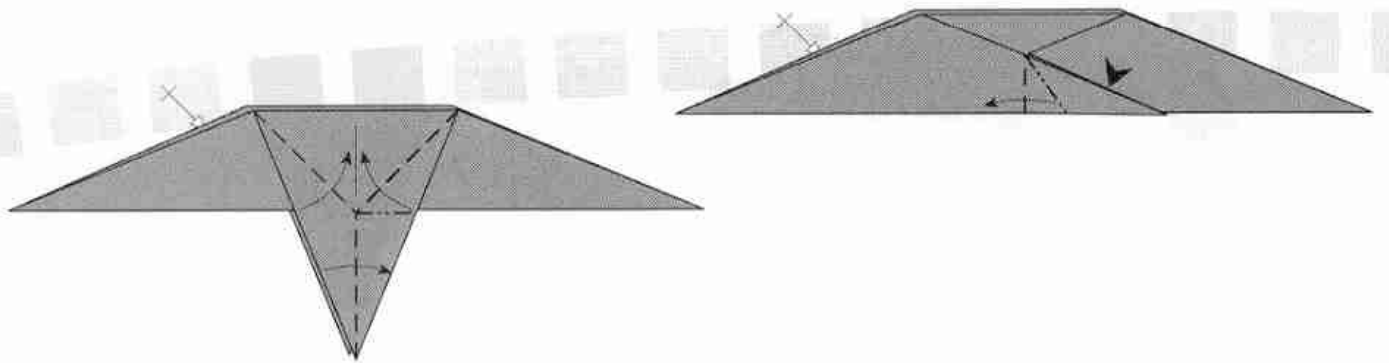
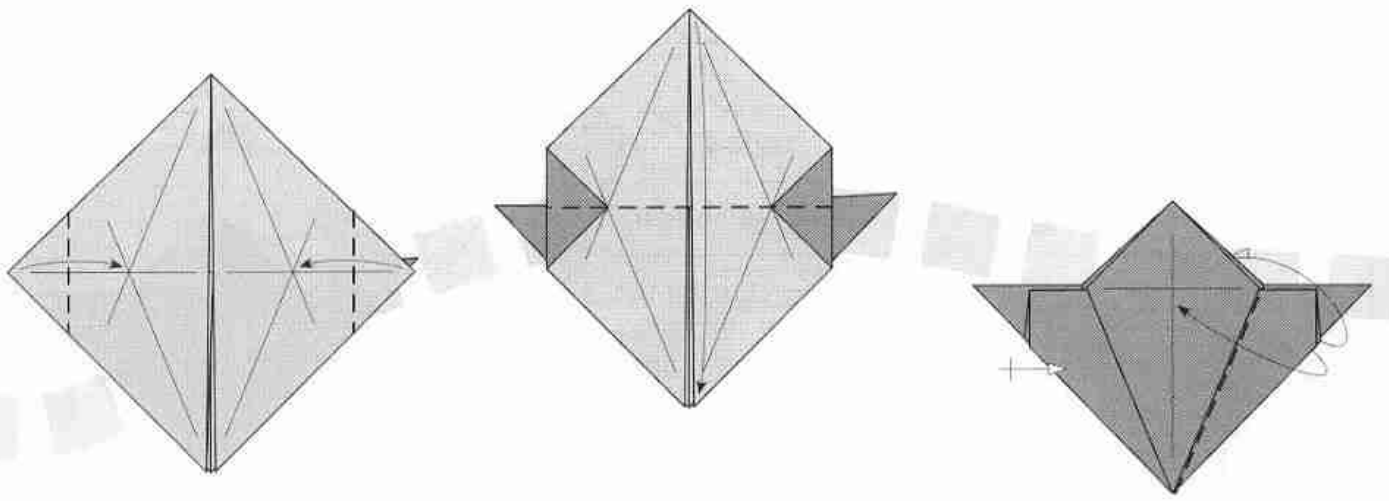

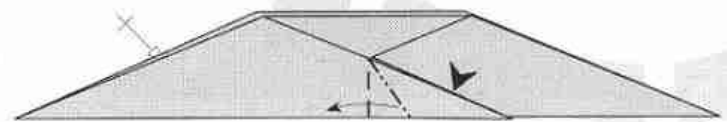
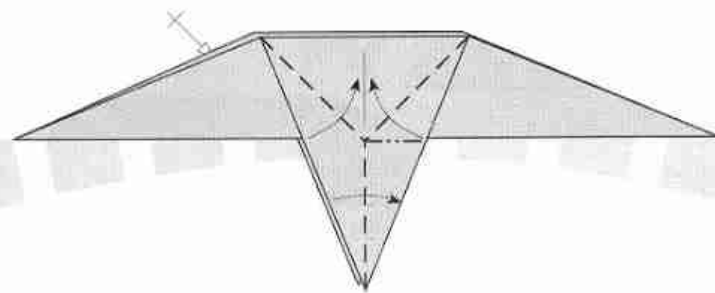
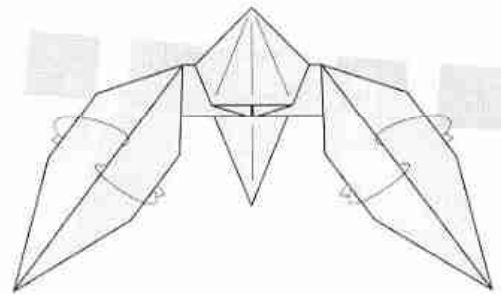
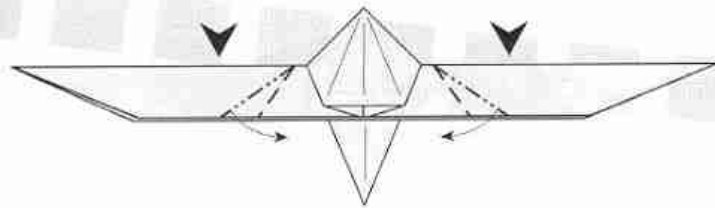
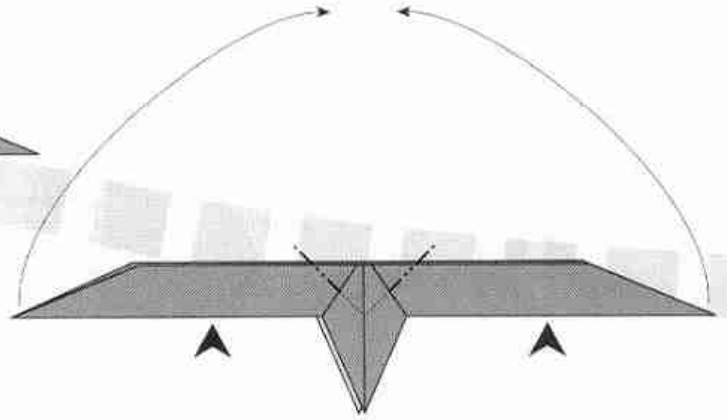
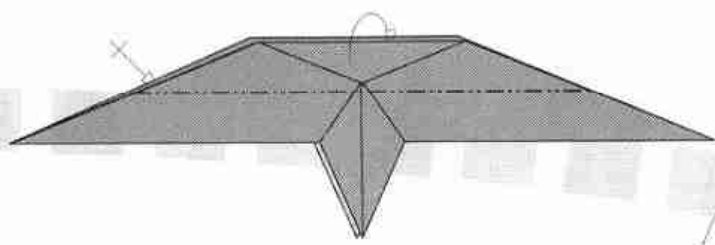
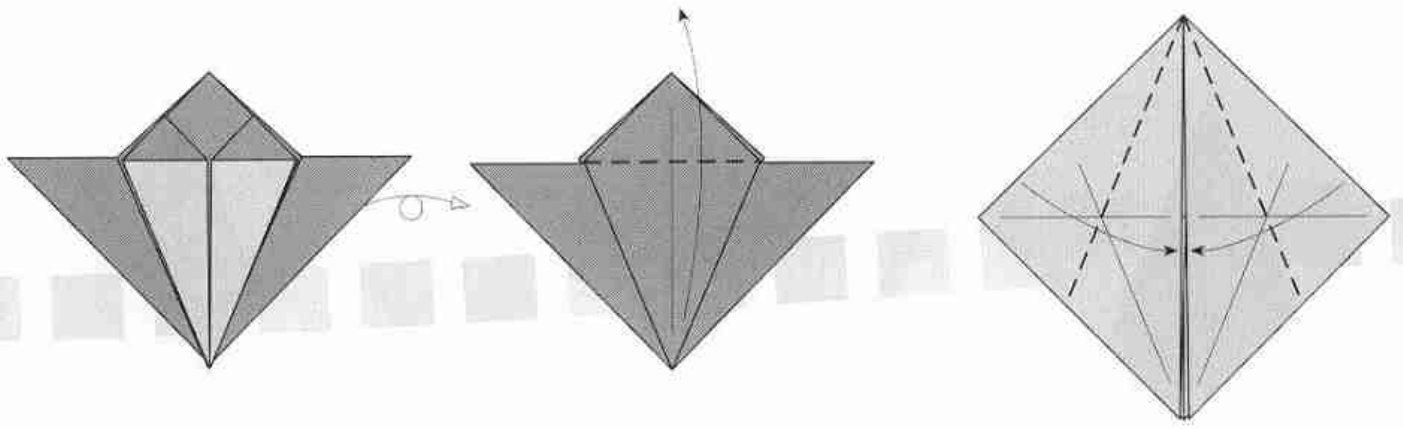

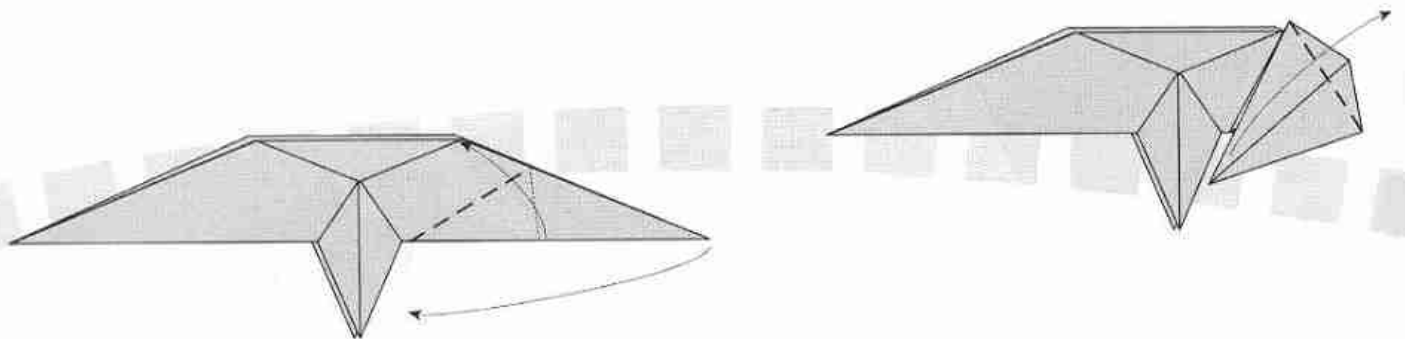
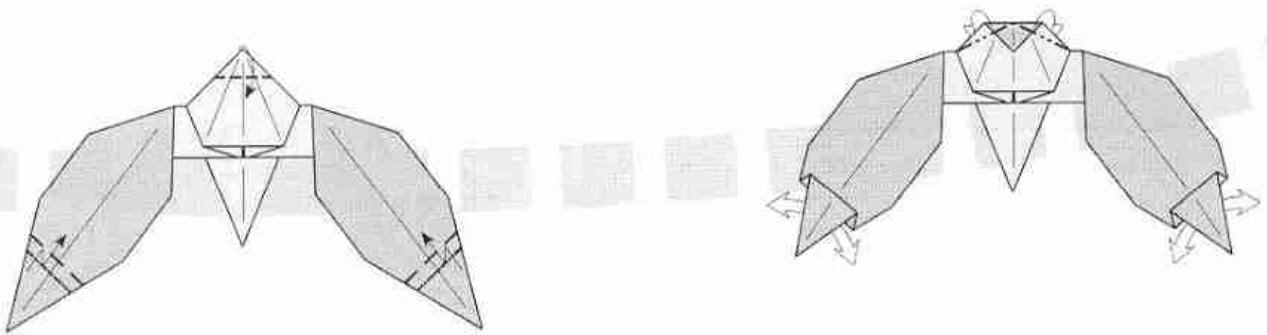
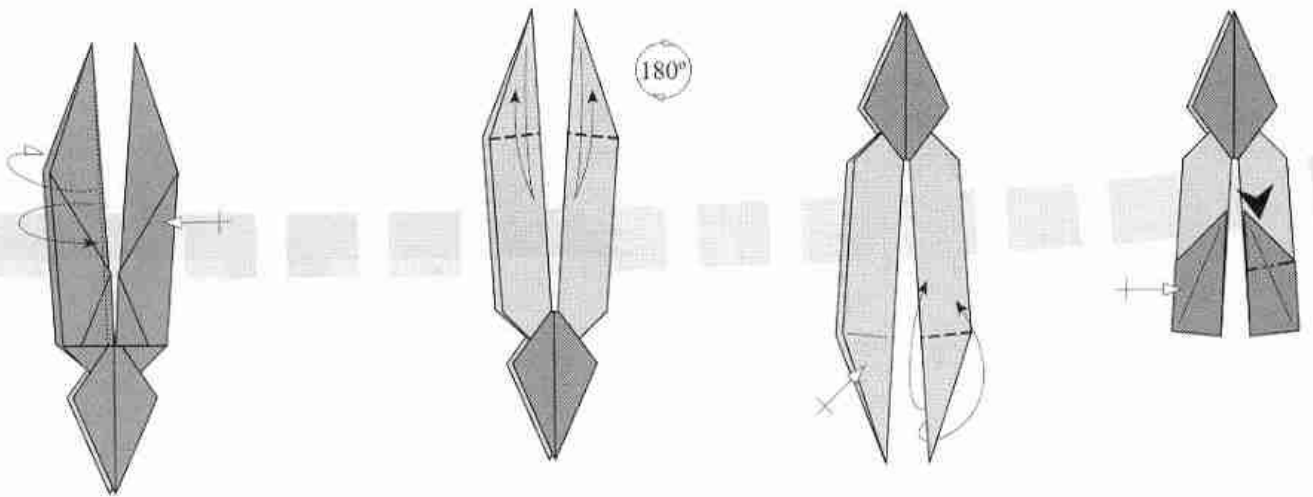
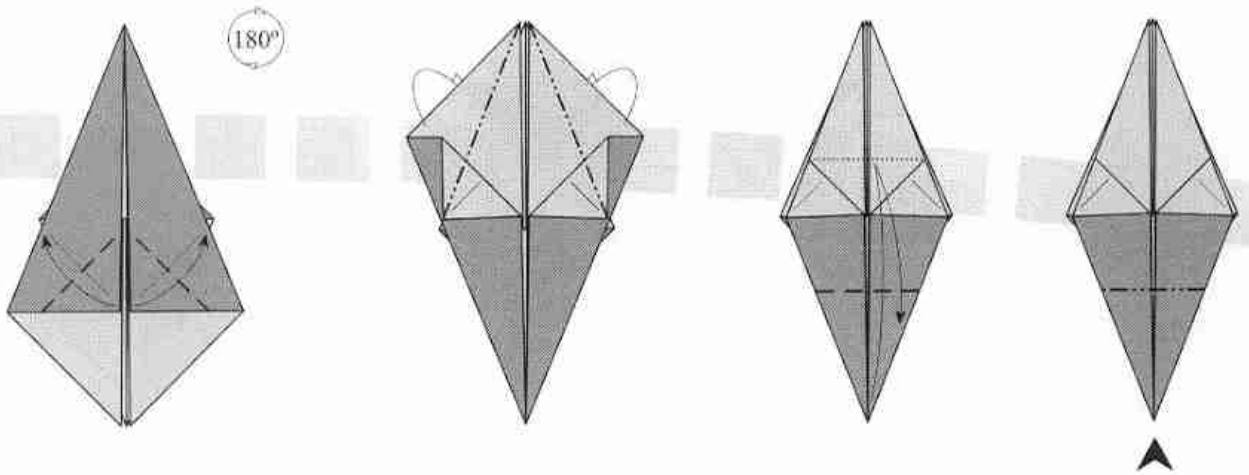

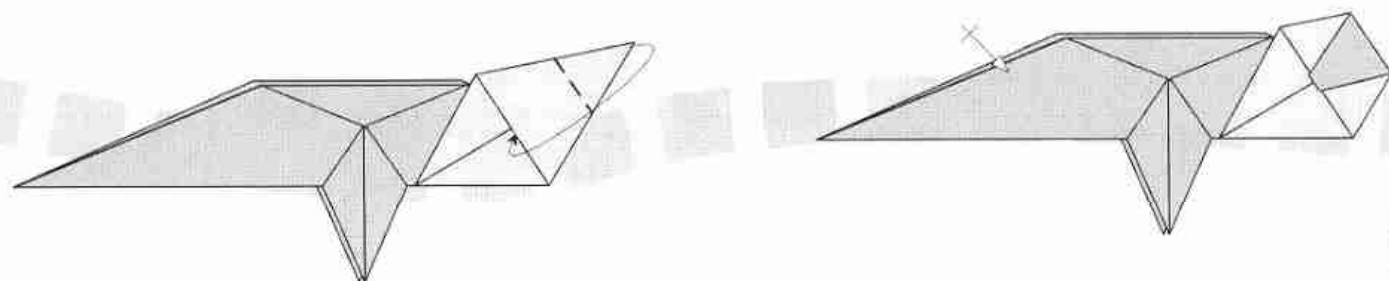
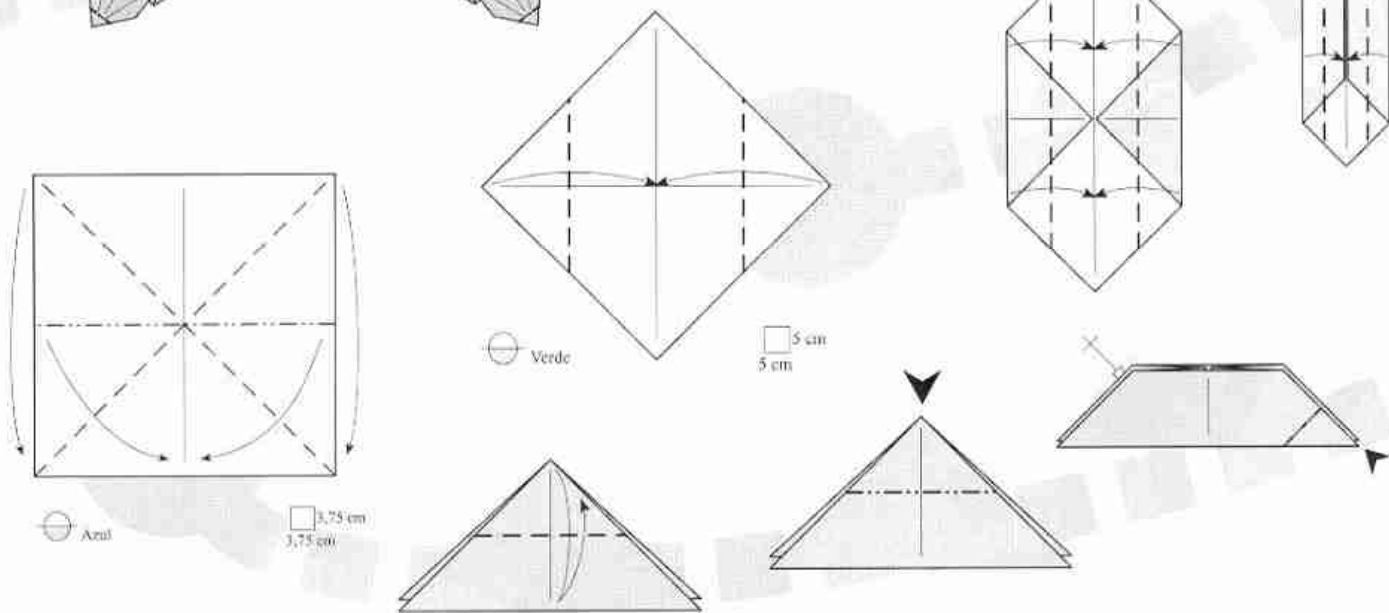
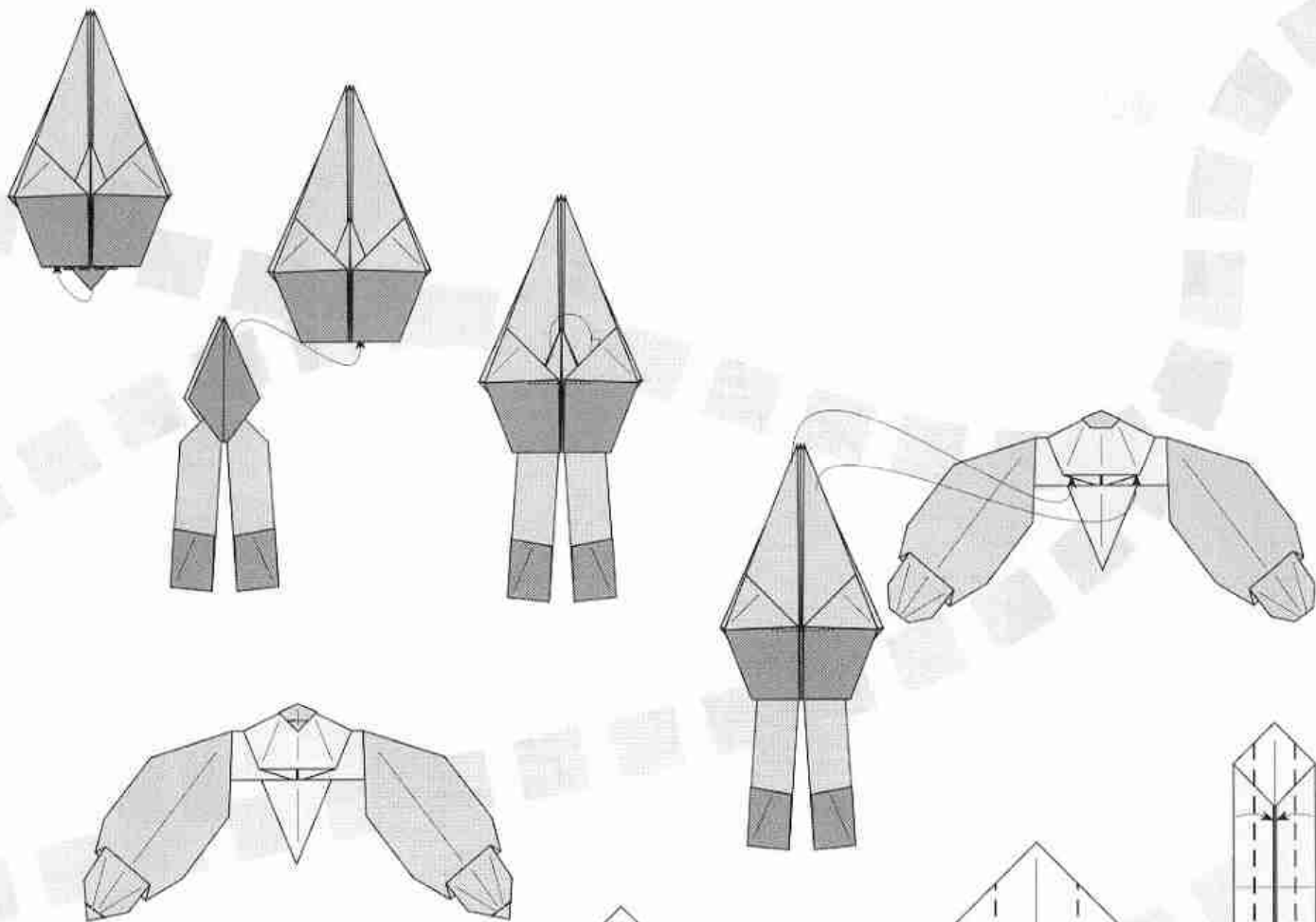

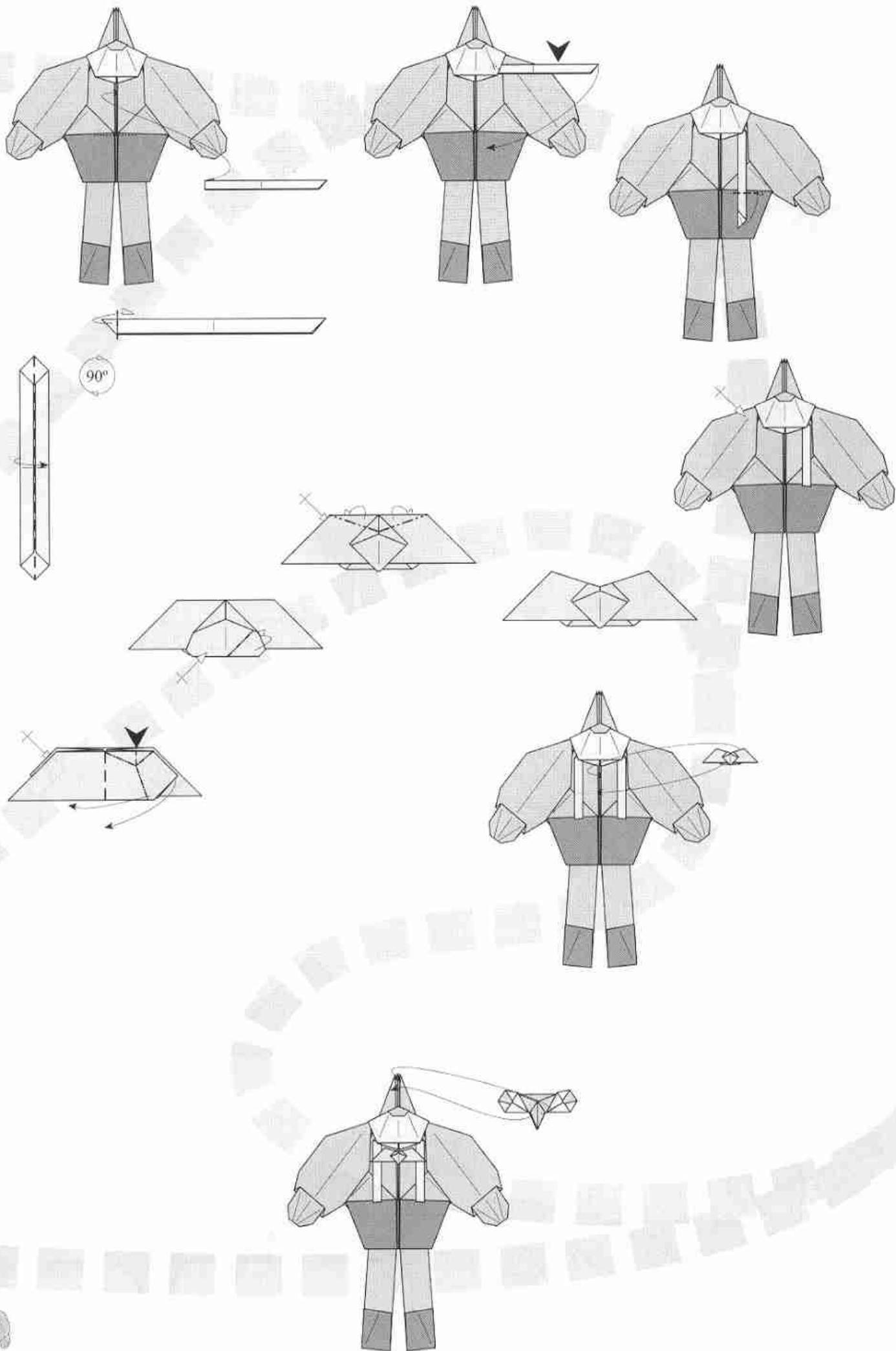

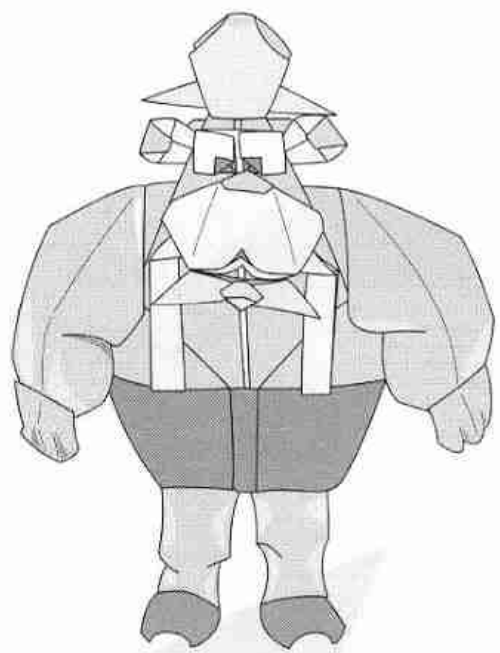
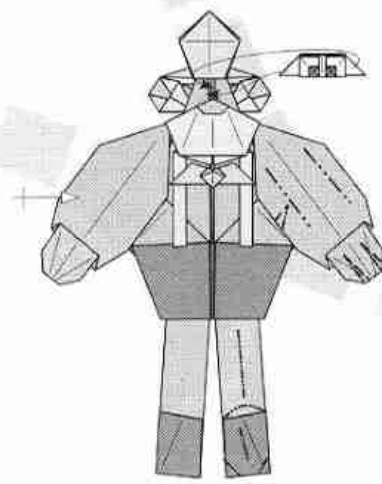
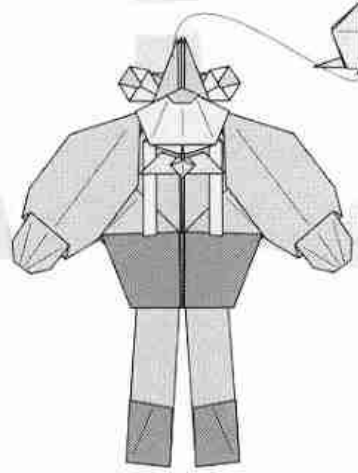
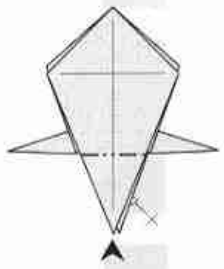
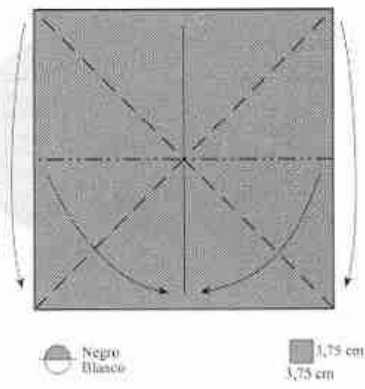
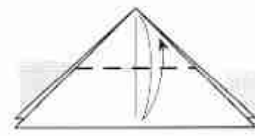
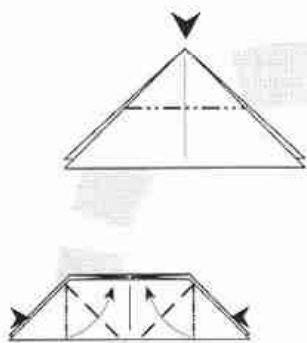
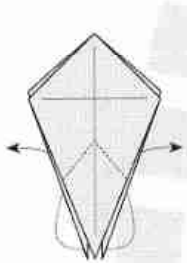
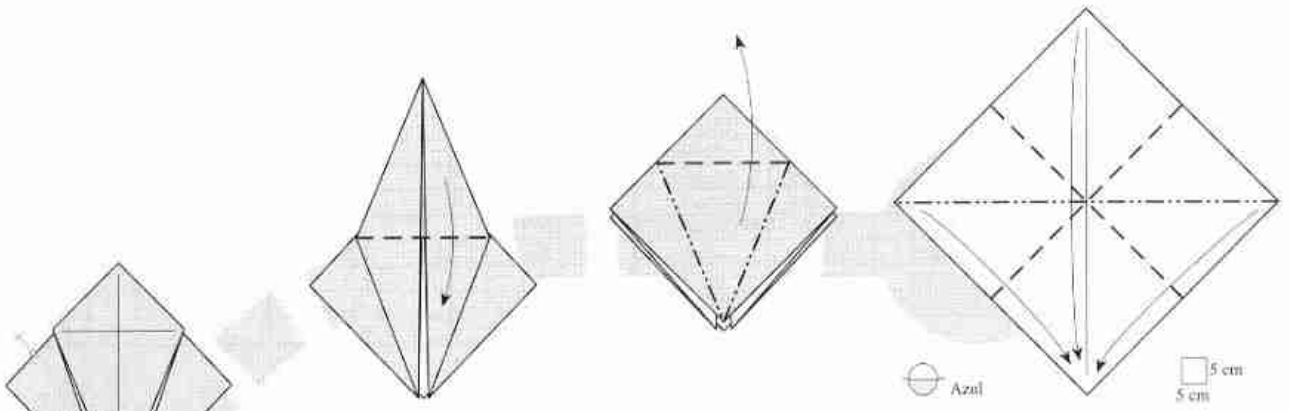

Página	Pieza nº	Cantidad	Porción	COLORES		Tamaño original	Tamaño 3/10	Tamaño 2/5	Tamaño 3/5
				Anverso	Reverso	19 cm alto	5,7 cm alto	7,6 cm alto	11,4 cm alto
						Lado (cm) =	Lado (cm) =	Lado (cm) =	Lado (cm) =
128	1	1	Ojos	Amarillo	Blanco	5	1,5	2	3
128	2	2	Cara	Verde	Verde	10	3	4	6
130	3	1	Boca	Neutro	Amarillo	10	3	4	6
128	4	1	Cuerpo (1)	Neutro	Amarillo	20	6	8	12
127	5	1	Cuerpo (2)	Verde	Neutro	30	9	12	18
127	6	1	Brazos	Blanco	Verde	25	7,5	10	15
130	7	2	Manos	Neutro	Verde	5	1,5	2	3
131	8	1	Sombrero	Violeta	Neutro	20	6	8	12
132	9	1	Cola	Neutro	Verde	15	4,5	6	9

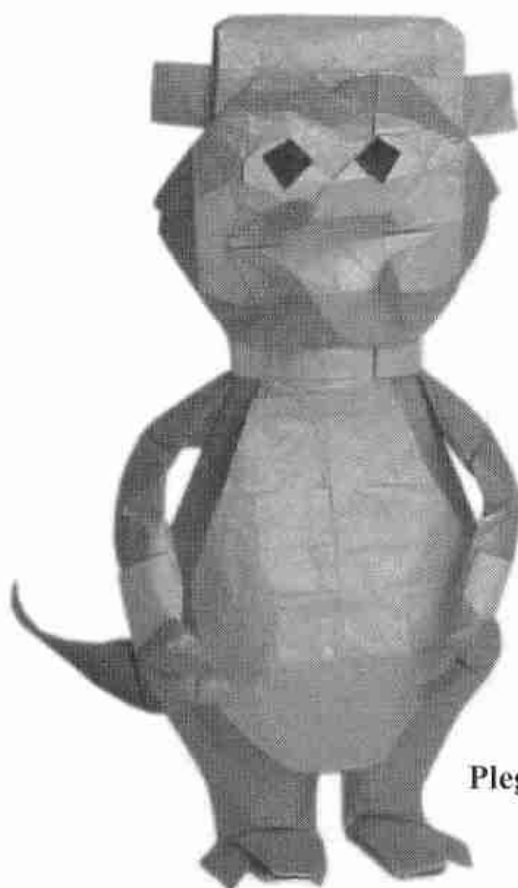

Plegado por: Nicolas Terry

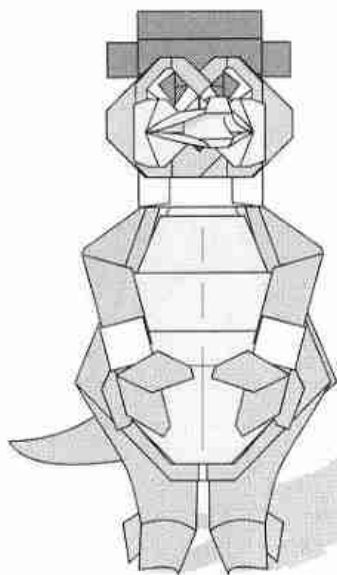

Utilizando las medidas recomendadas, se obtiene un modelo final de 19 cms.

Autor:	Halle
Nivel de dificultad:	Medio-Alto
Número de piezas:	11
Forma de las piezas:	Cuadrados

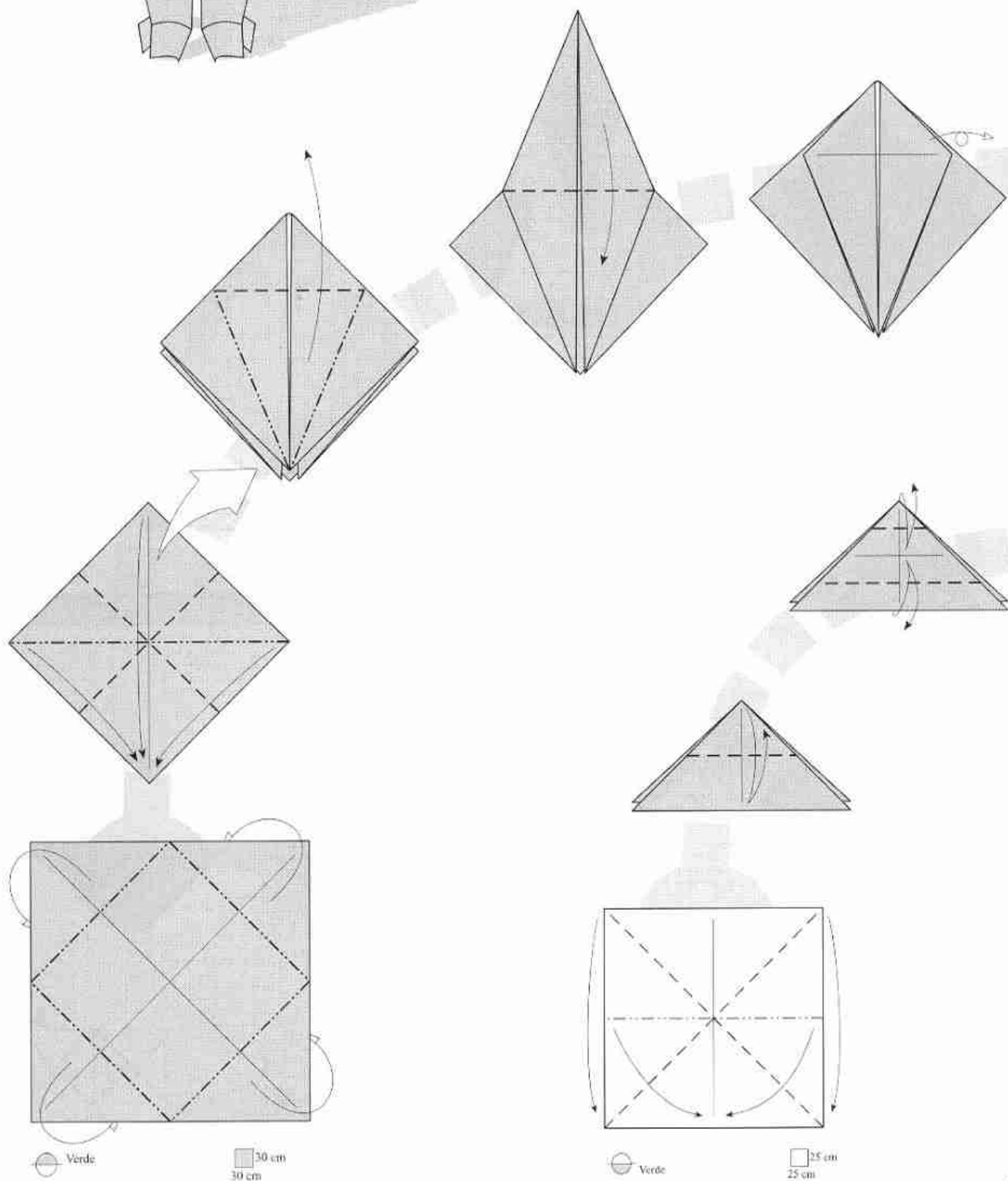

Verde

30 cm
30 cm

Verde

25 cm
25 cm



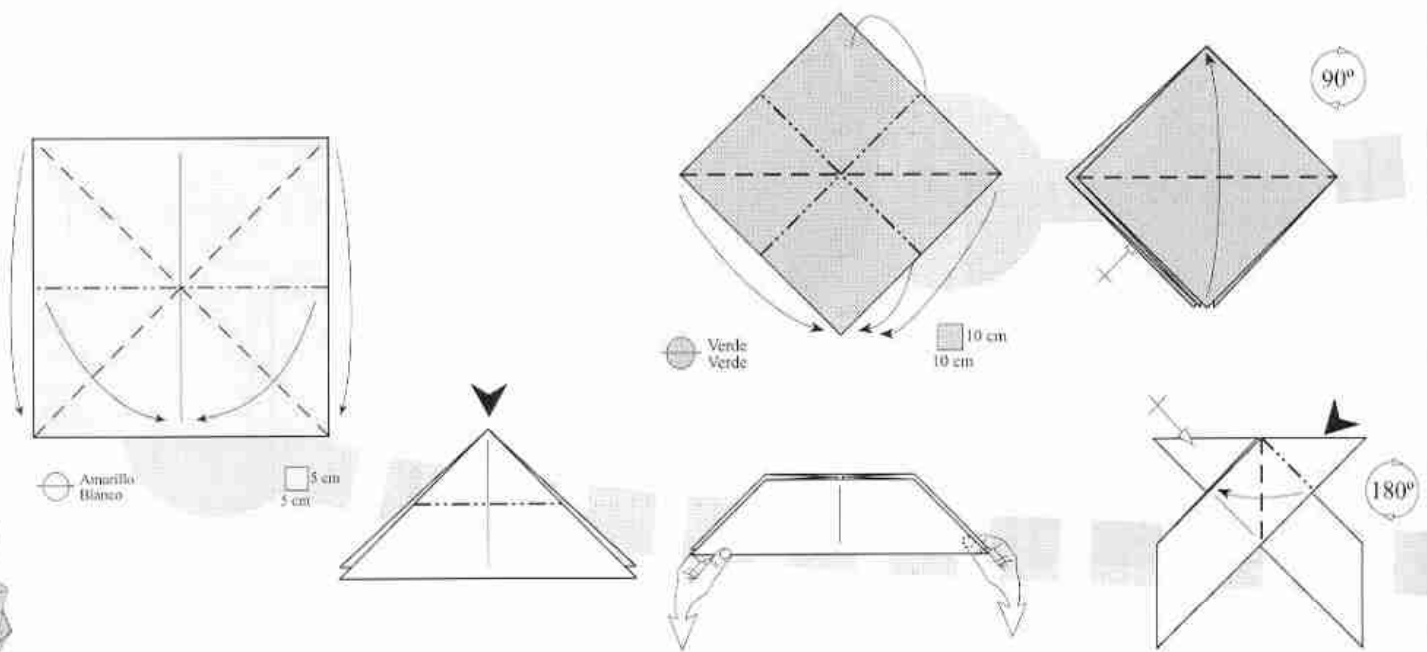
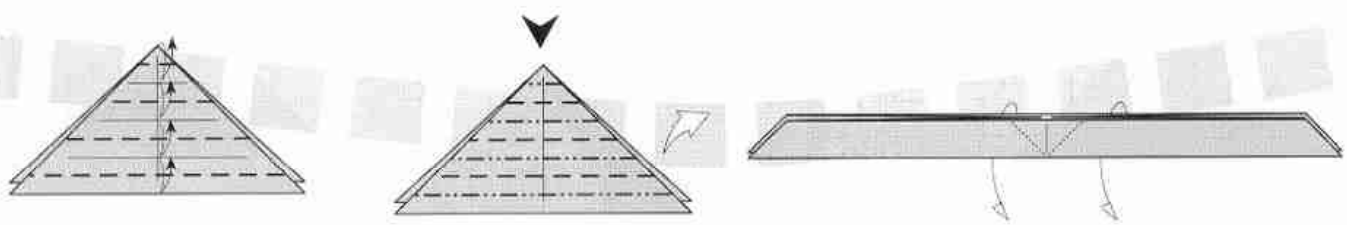
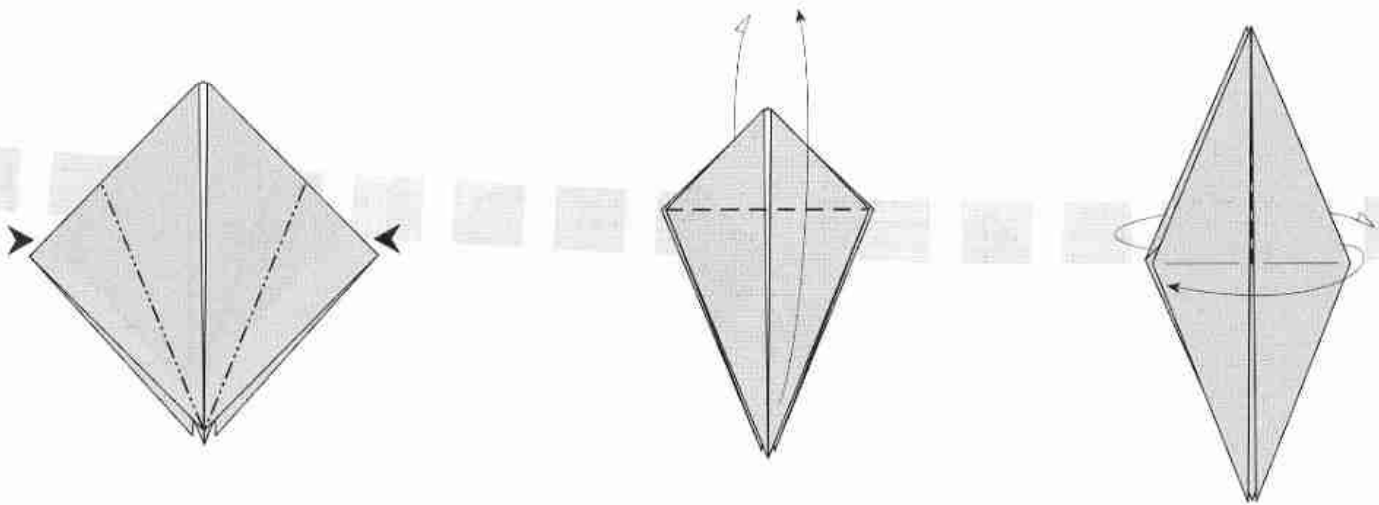
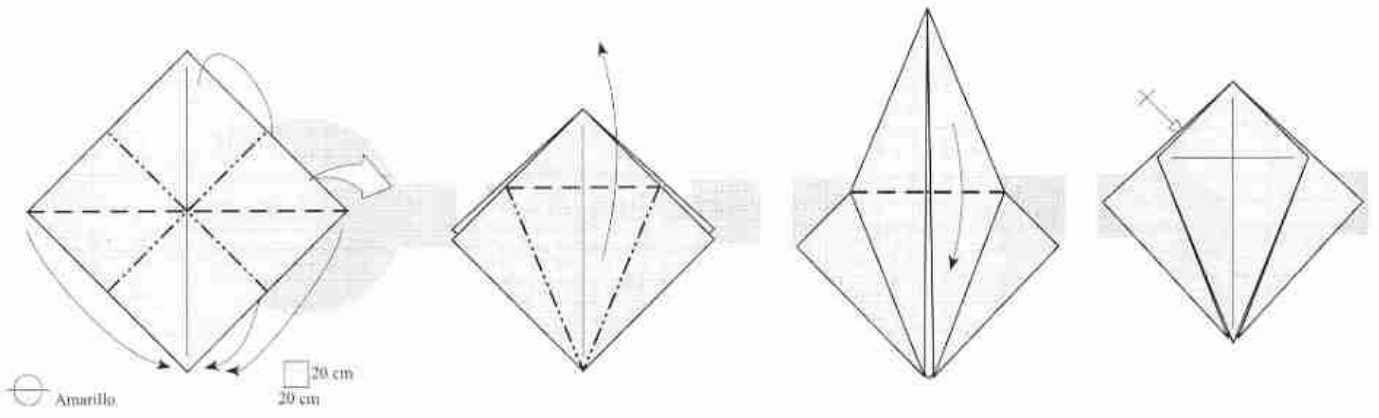

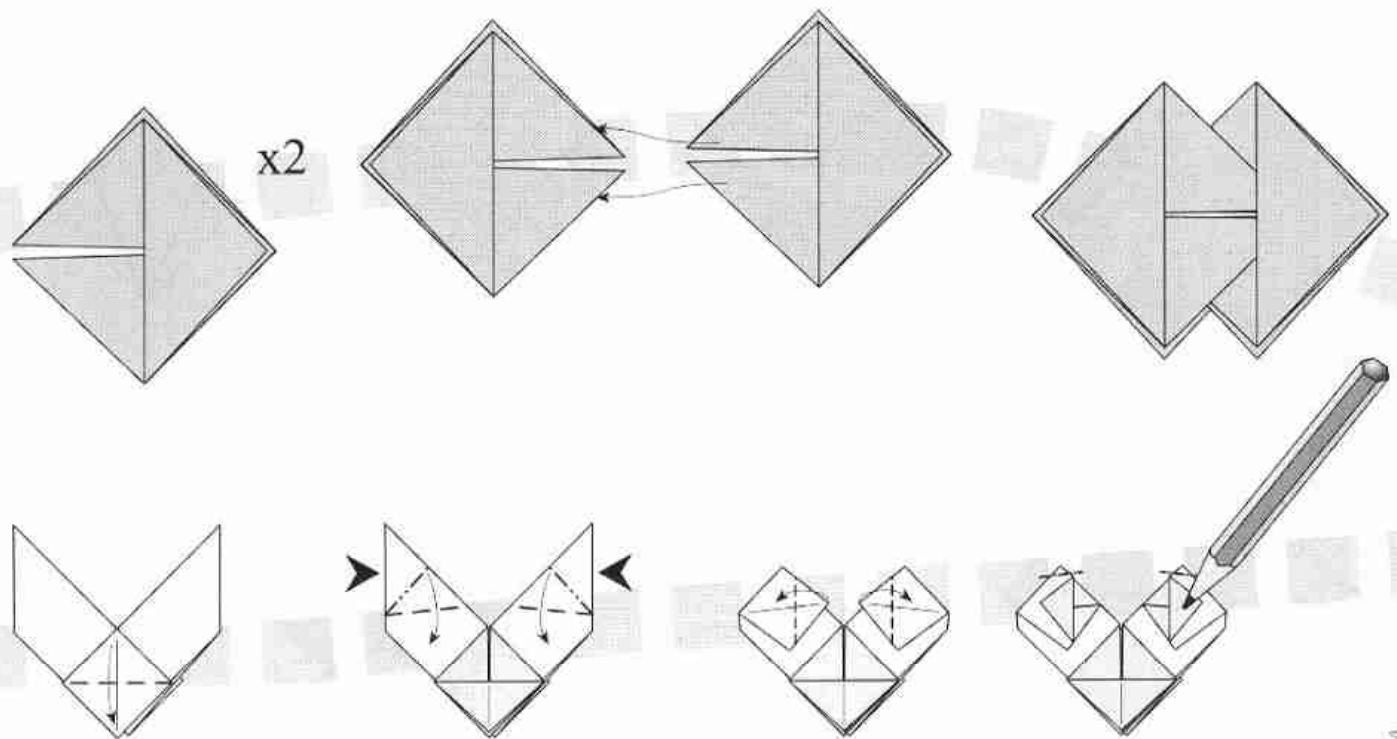
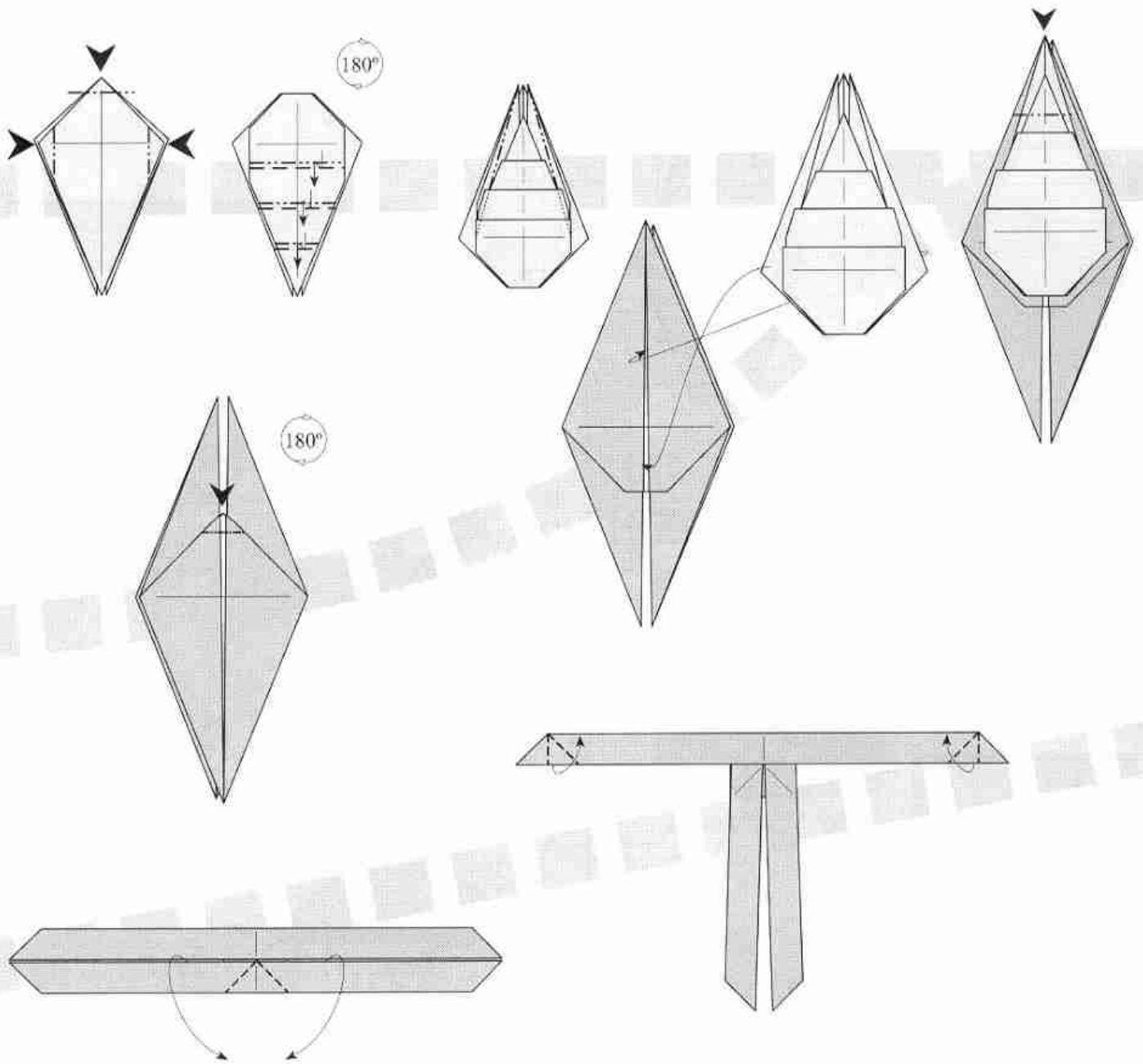

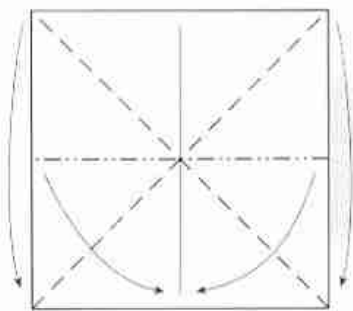
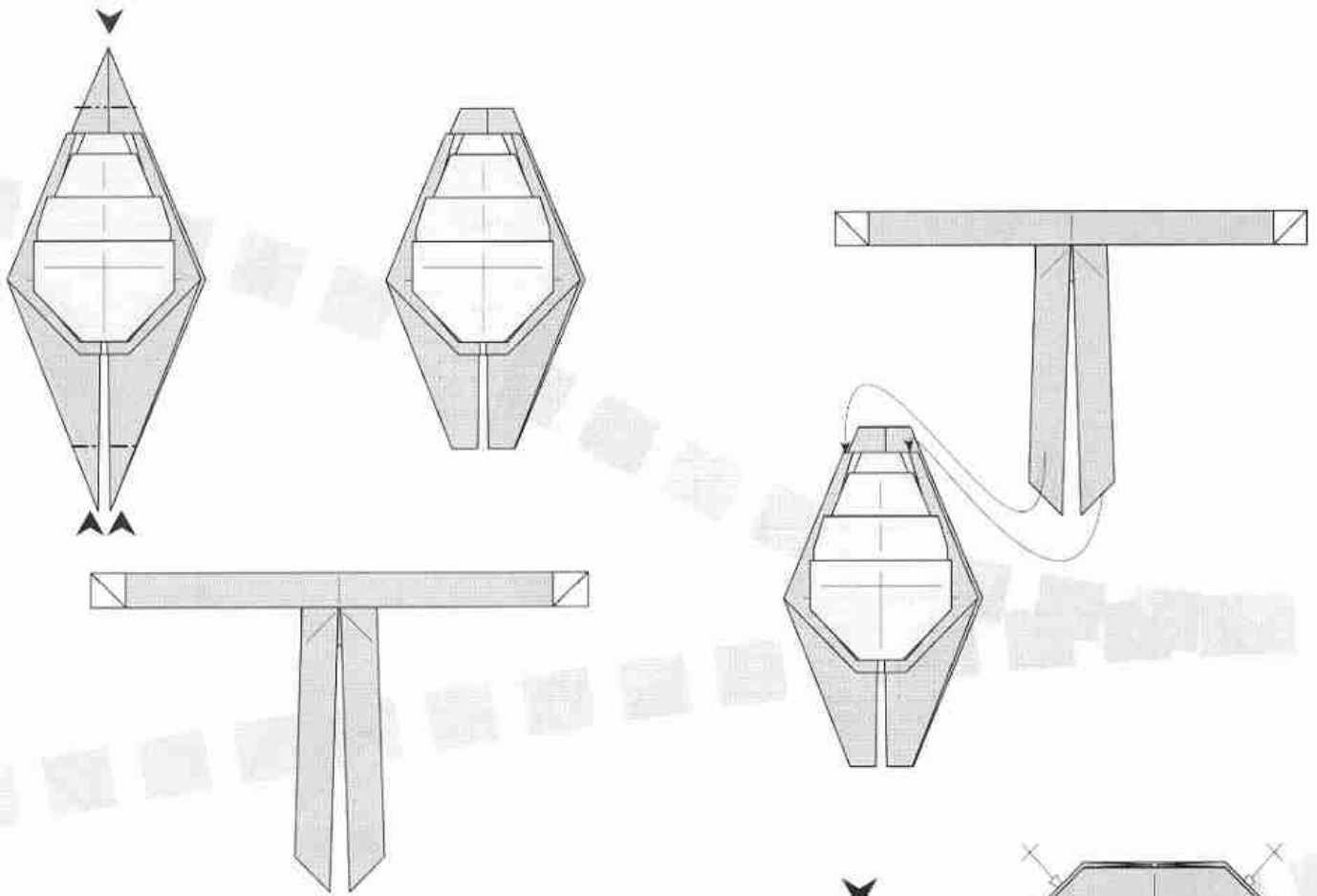

Verde

5 cm
5 cm

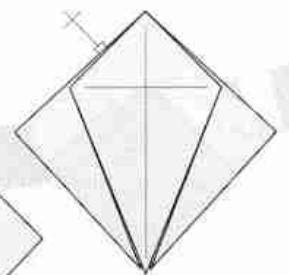
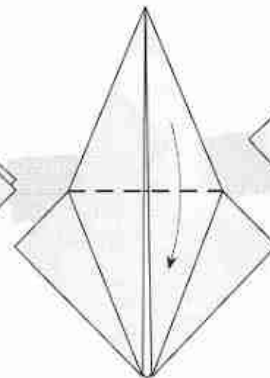
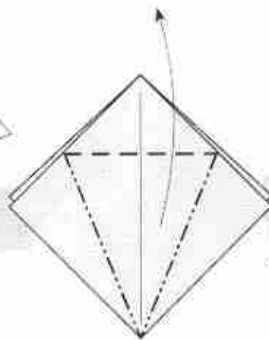
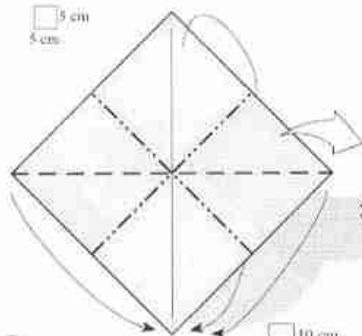
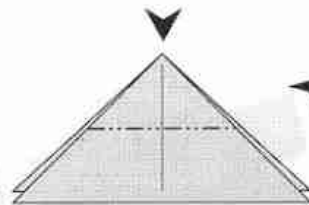
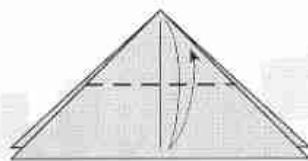

Amarillo

10 cm
10 cm

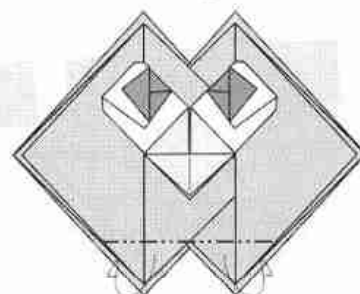
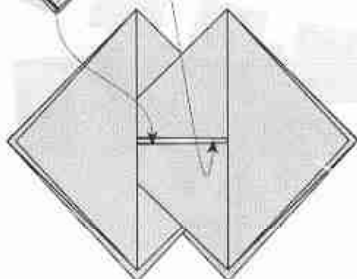

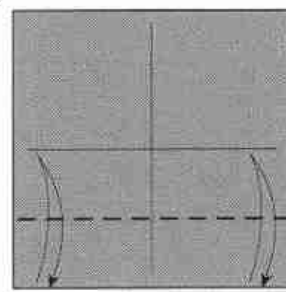
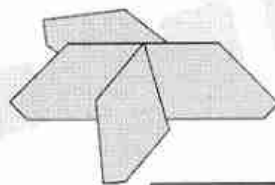
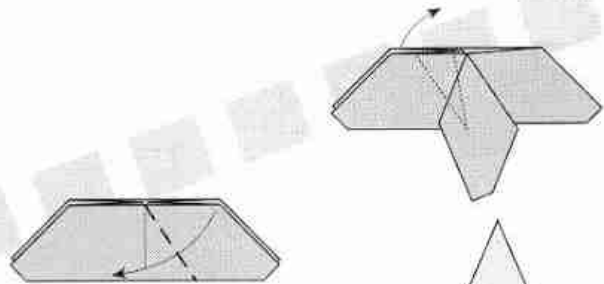
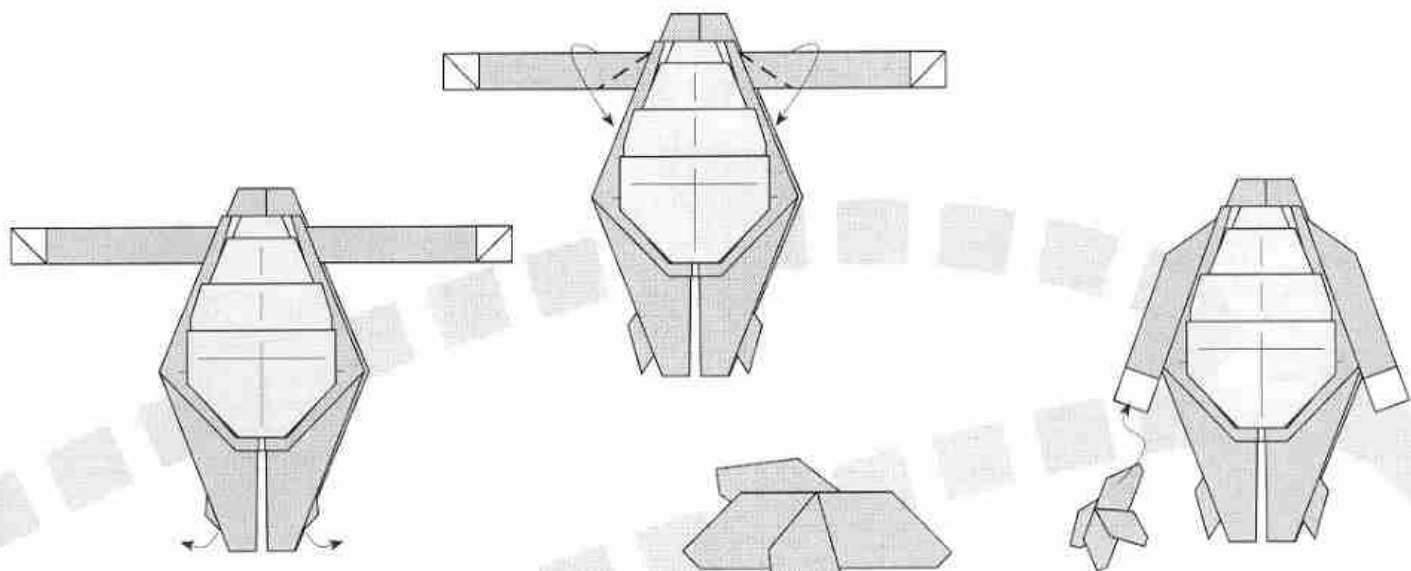

● Violeta ■ 15 cm
 15 cm

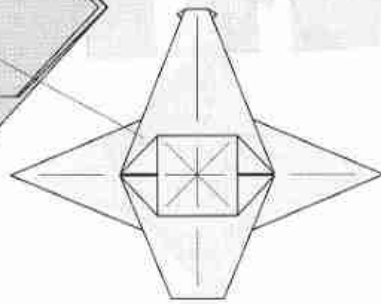
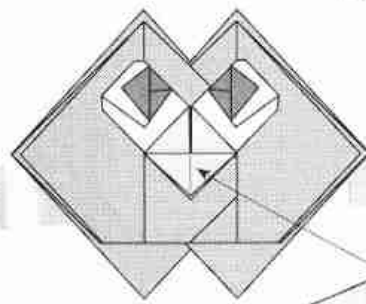
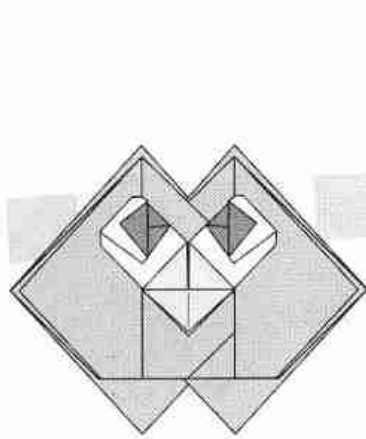
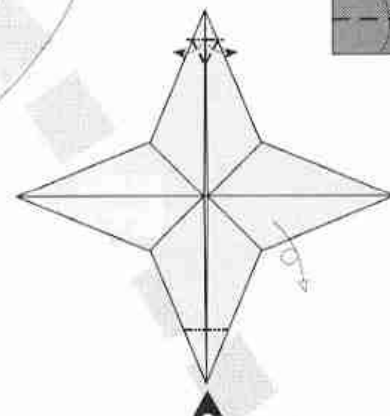
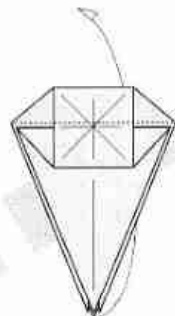
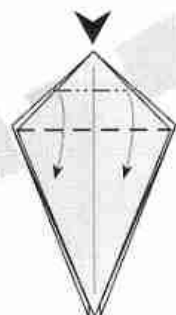
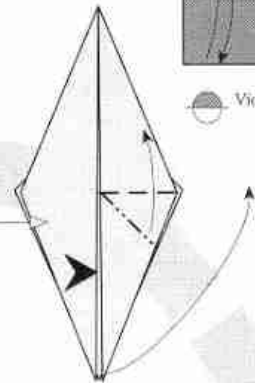
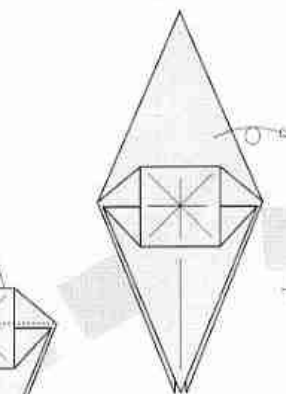
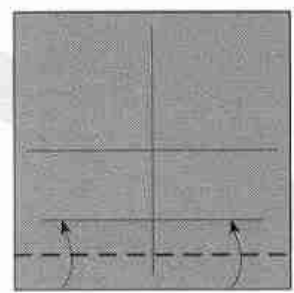

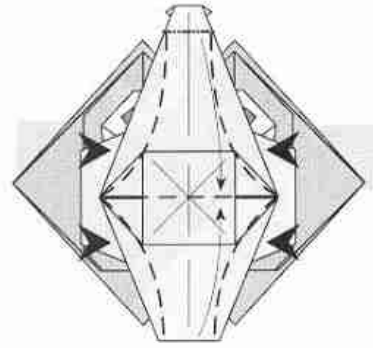
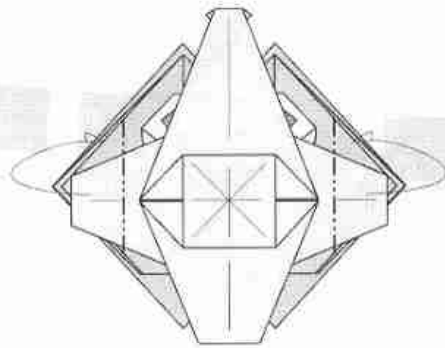
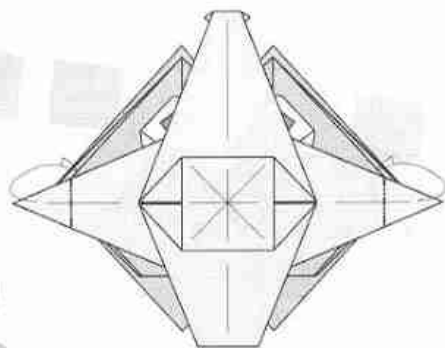
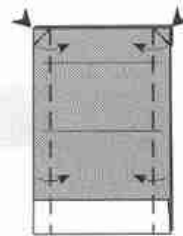
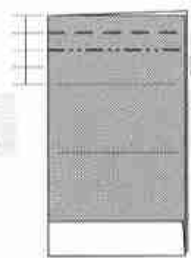
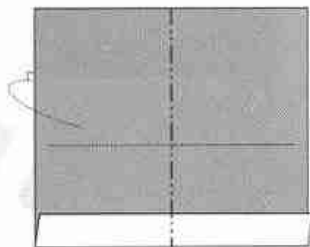
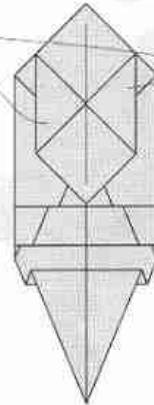
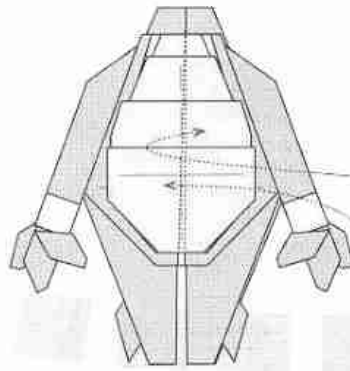
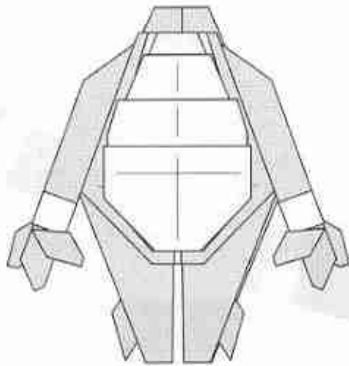
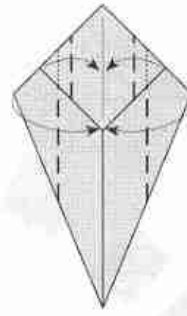
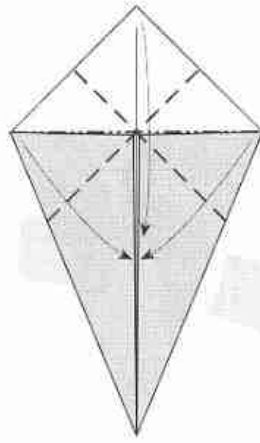
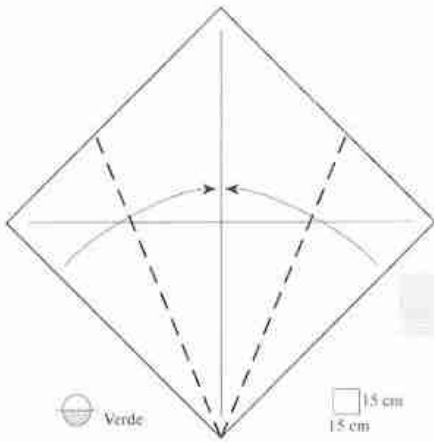

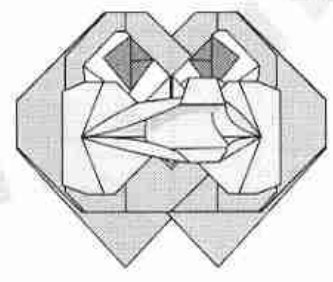
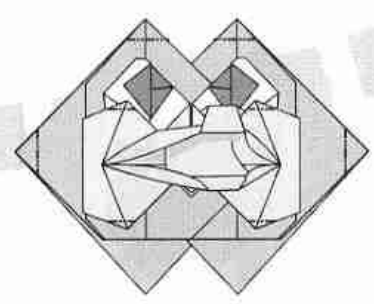
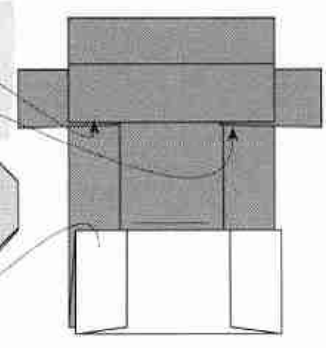
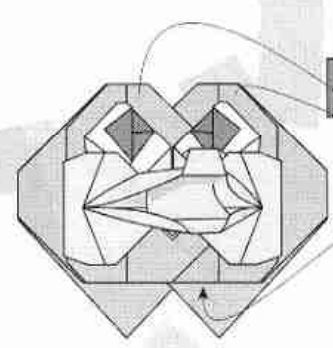
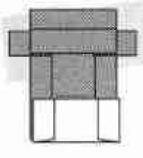
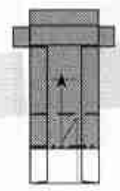
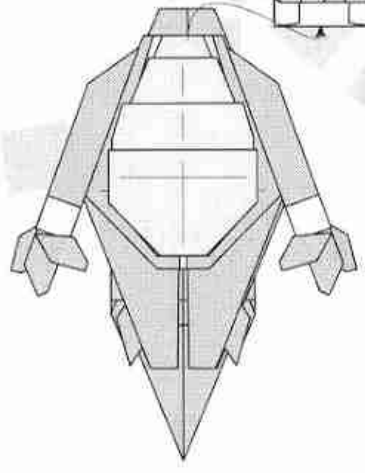
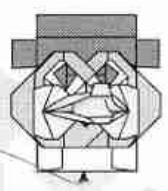
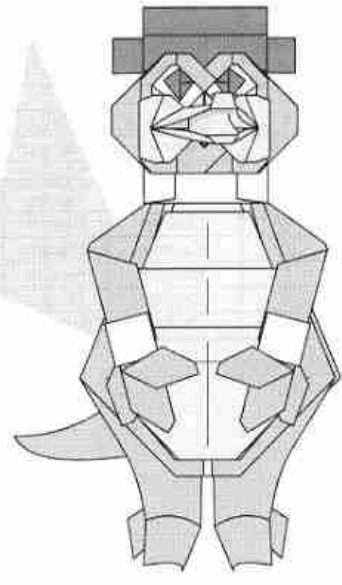
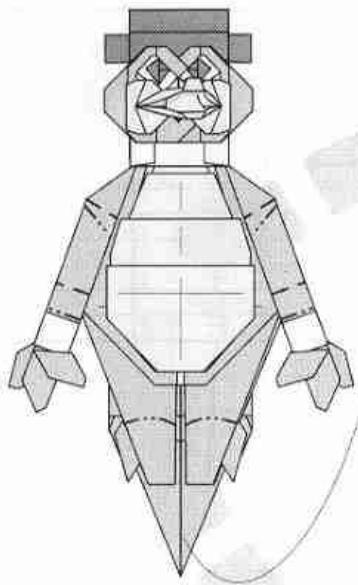

Página (Desarr.)	Pieza nº	Cantidad	Porción	COLORES		Tamaño original	Tamaño 3/10	Tamaño 2/5	Tamaño 3/5
				Anverso	Reverso	15 cm alto	4,5 cm alto	6 cm alto	9 cm alto
						Lado (cm) =	Lado (cm) =	Lado (cm) =	Lado (cm) =
135	1	1	Base cara	Blanco	Neutro	10	3	4	6
136	2	1	Boca	Neutro	Negro	4	1,2	1,6	2,4
137	3	2	Ojos	Neutro	Negro	1,3	0,39	0,52	0,78
136	4	1	Orejas	Neutro	Negro	10	3	4	6
135	5	1	Cuerpo	Blanco	Rojo	20	6	8	12
135	6	1	Piernas	Neutro	Bianco	15	4,5	6	9
137	7	1	Brazos	Neutro	Bianco	15	4,5	6	9
138	8	1	Caseta	Neutro	Bianco	20	6	8	12
139	9	1	Tejado	Neutro	Bianco	20	6	8	12

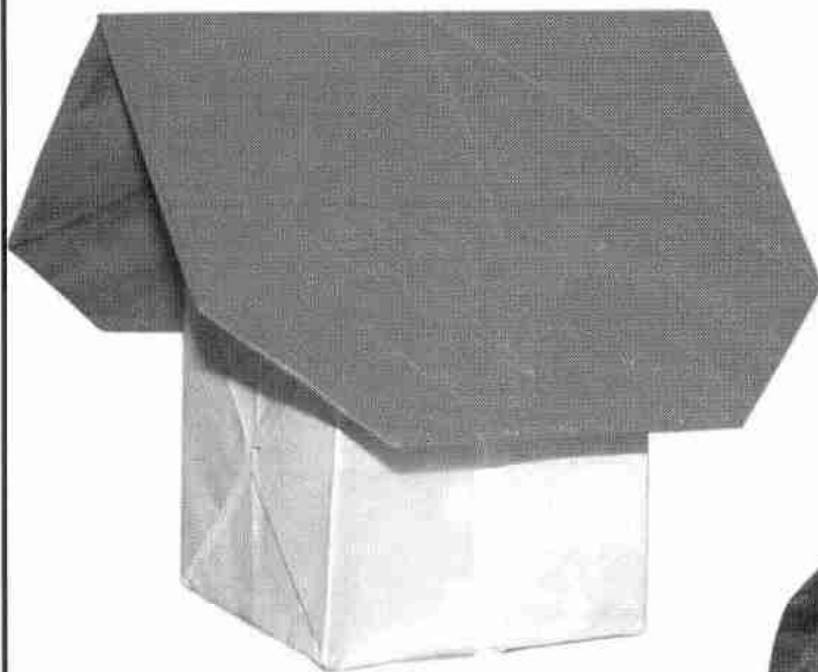

Plegado por: Halle

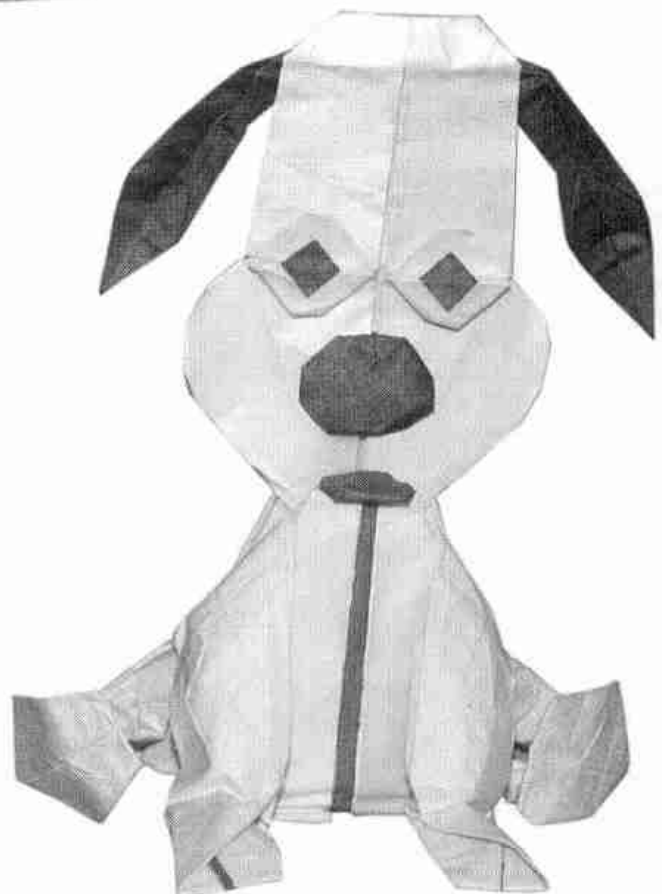



Utilizando las medidas recomendadas, se obtiene un modelo final de 15 cms.

Autor:	Halle
Nivel de dificultad:	Medio
Número de piezas:	8
Forma de las piezas:	Cuadrados

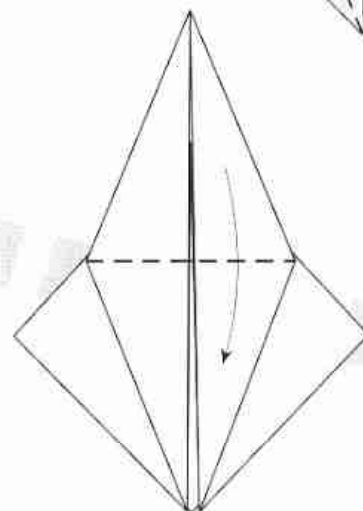
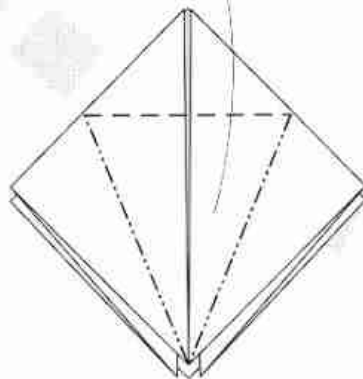
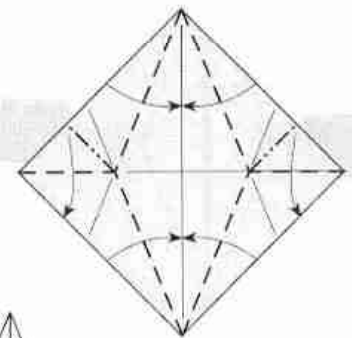
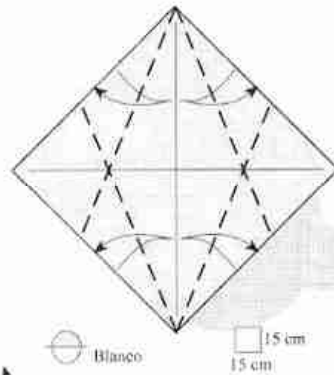
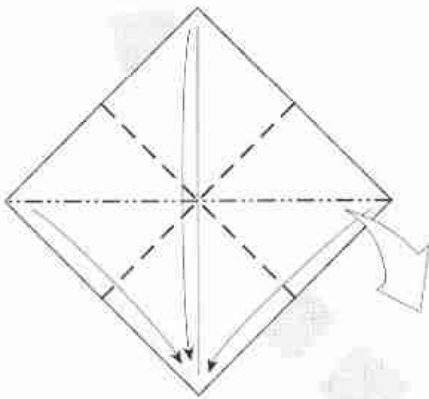
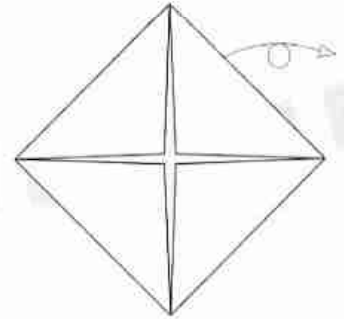
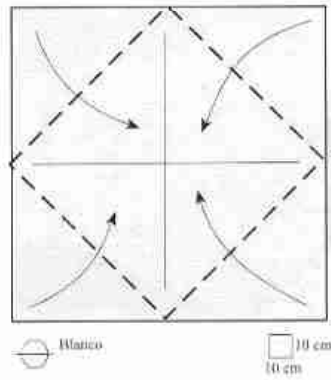
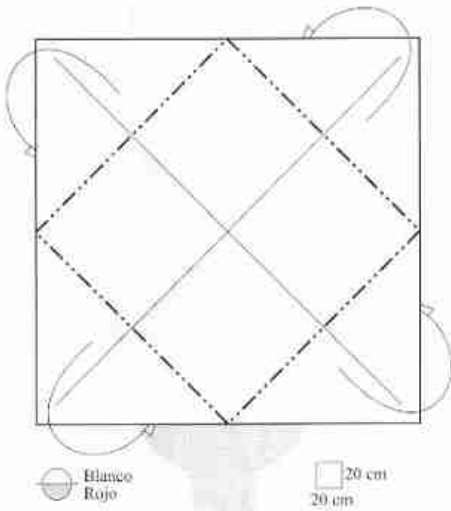

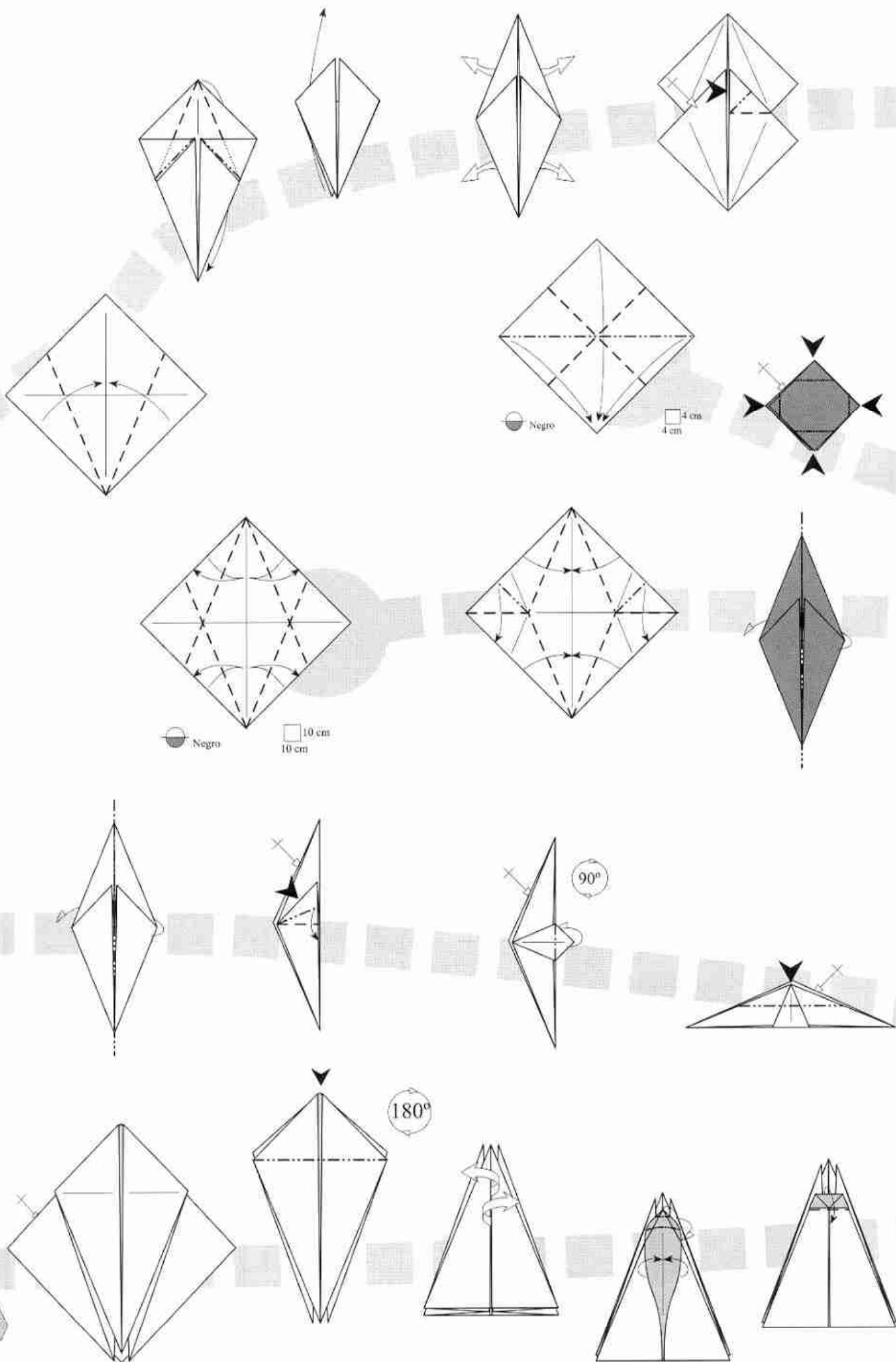

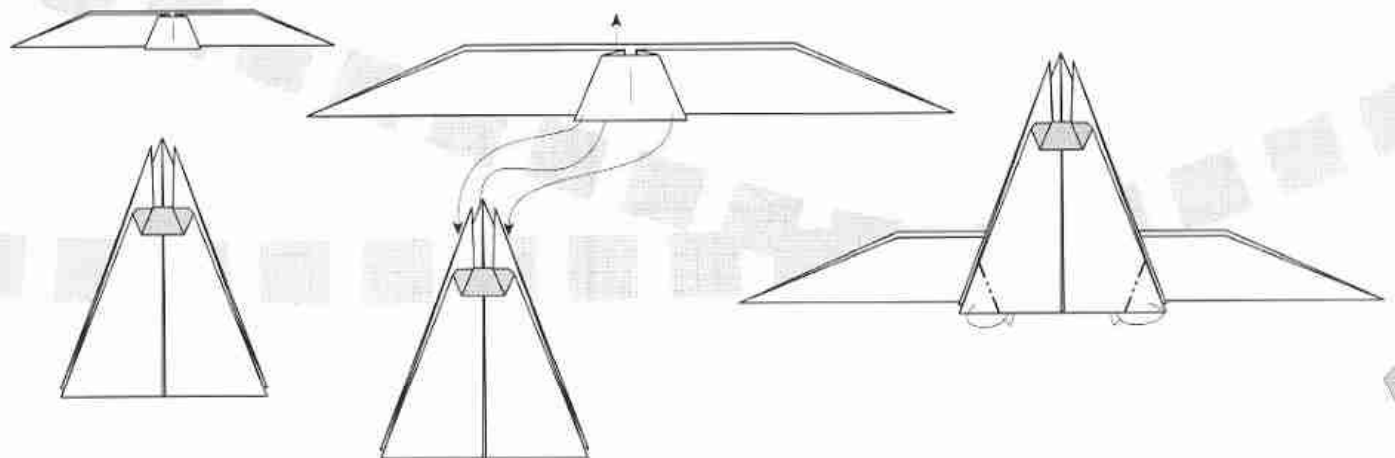
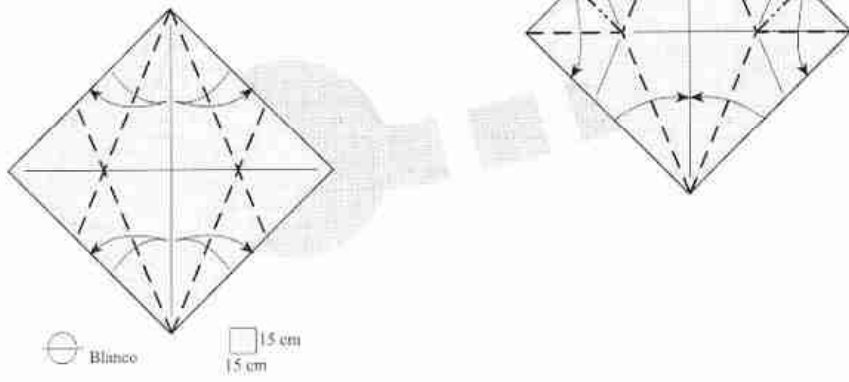
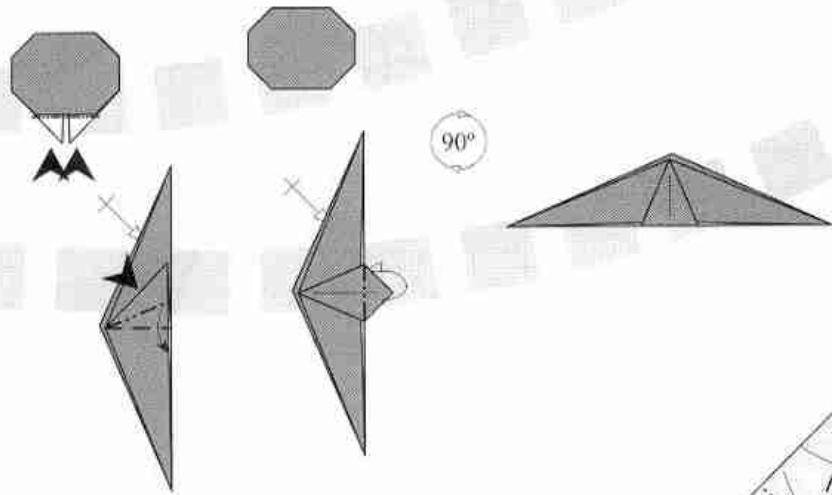
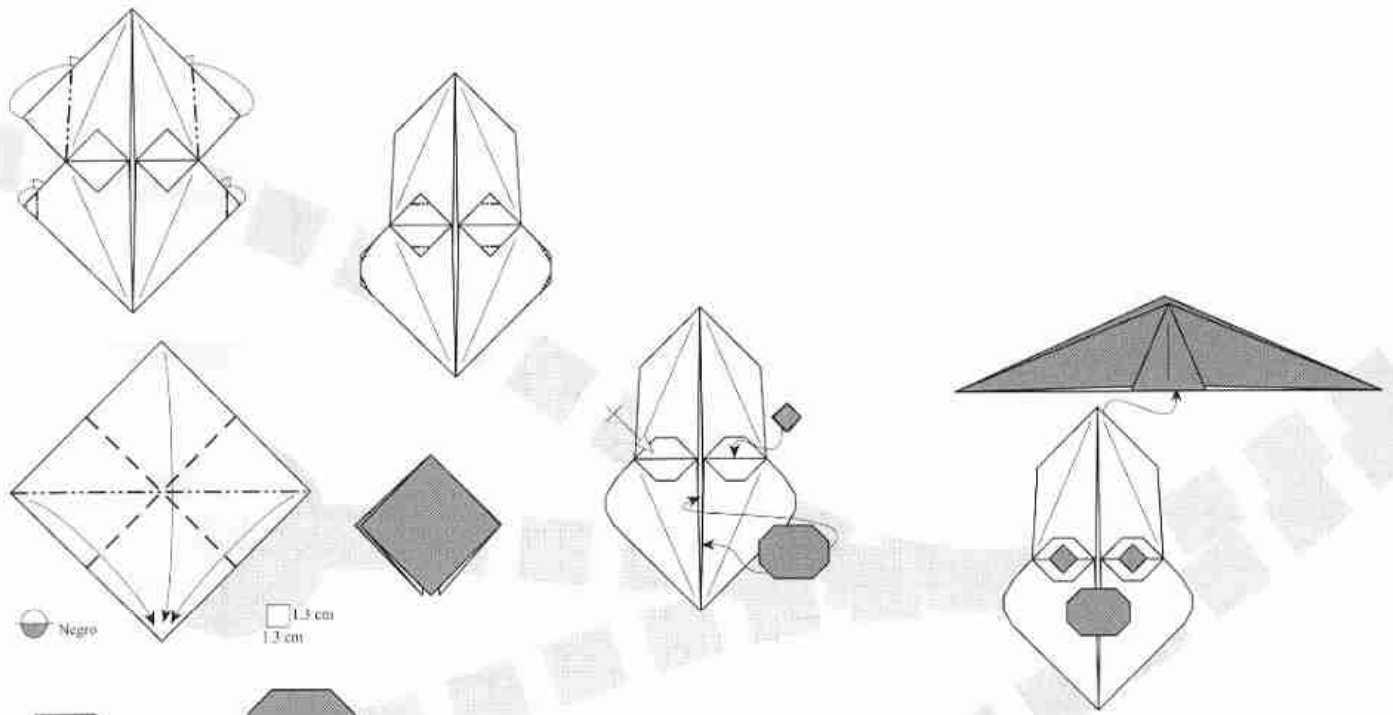

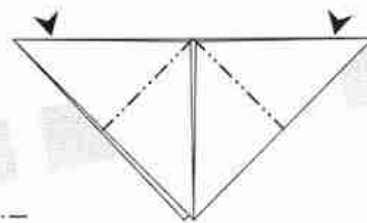
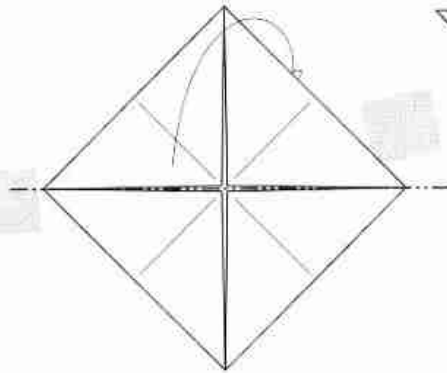
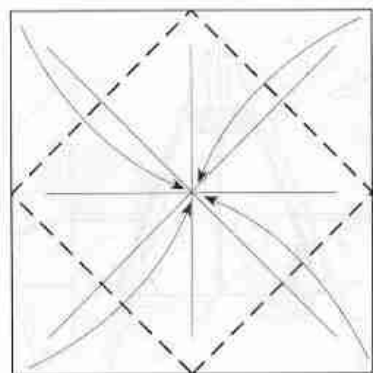
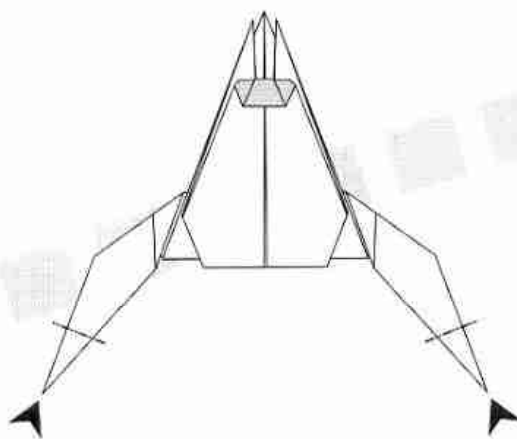
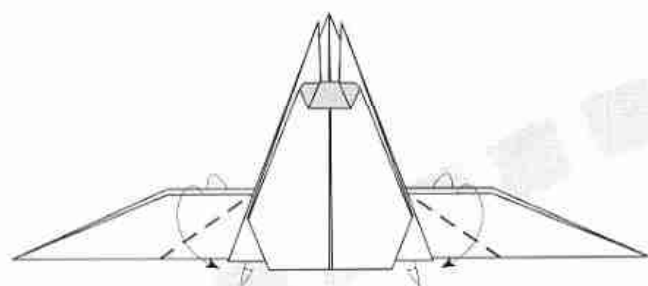
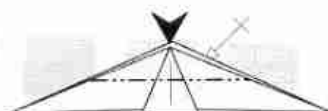
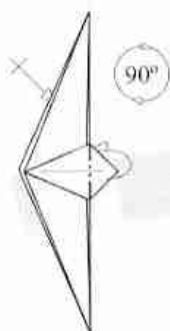
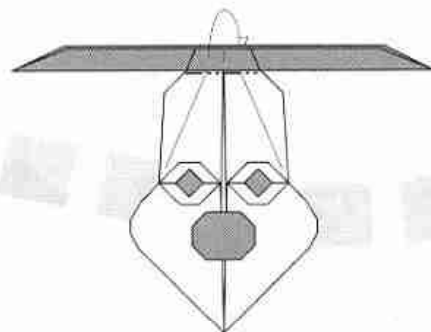
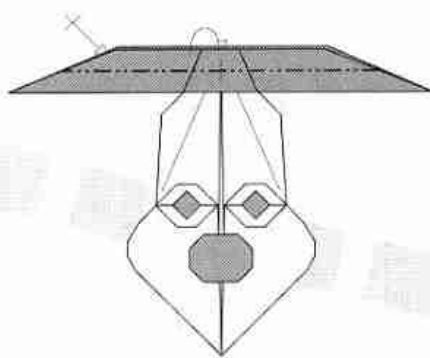
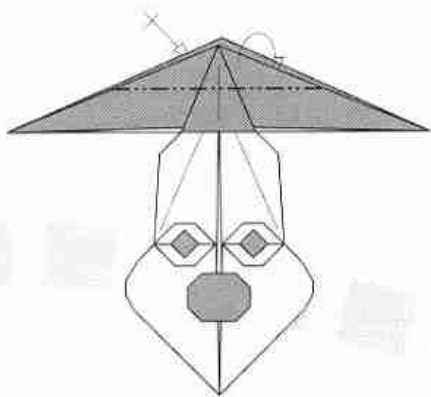

○ Bianco

□ 20 cm
20 cm



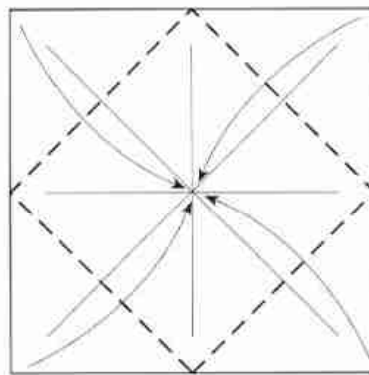
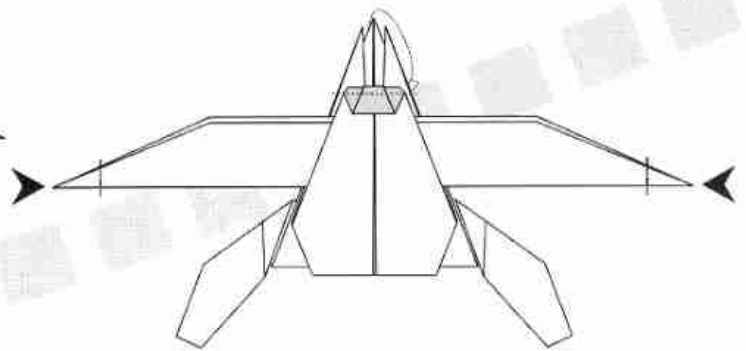
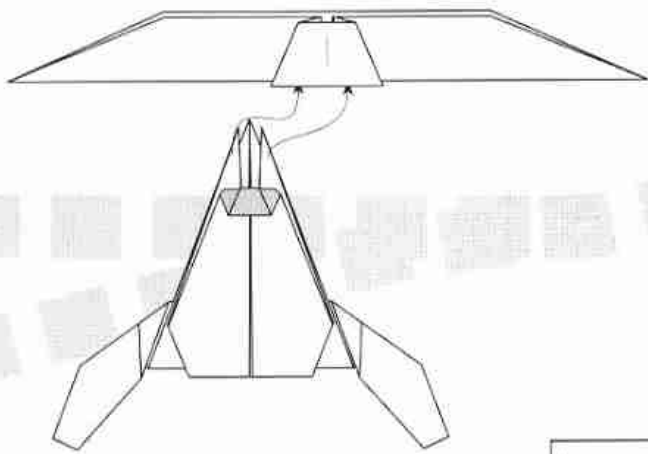
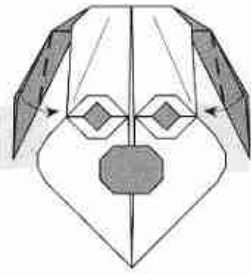
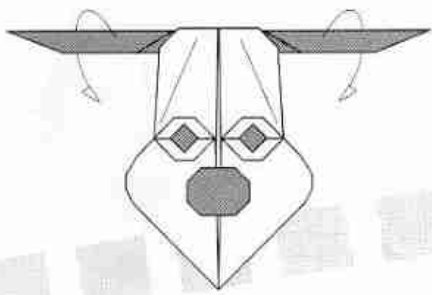

Blanco

20 cm
20 cm

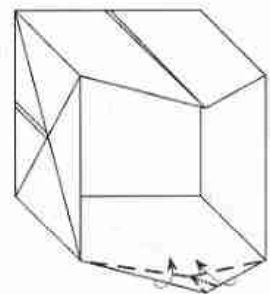
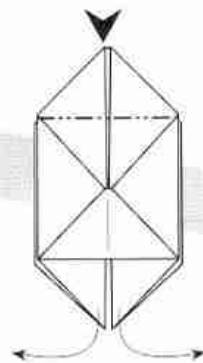
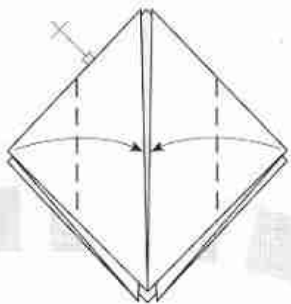
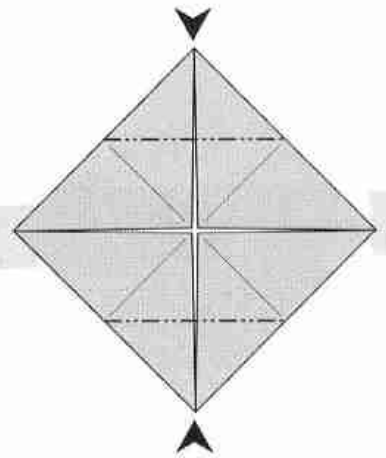

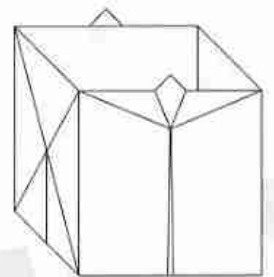
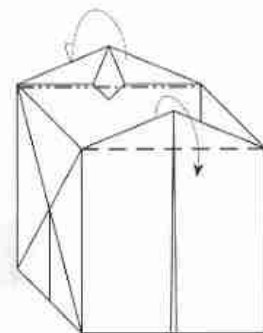
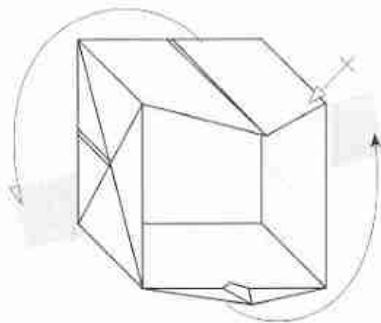
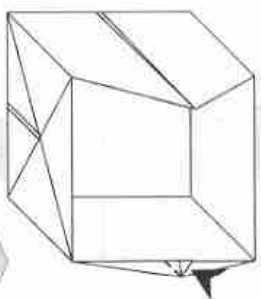
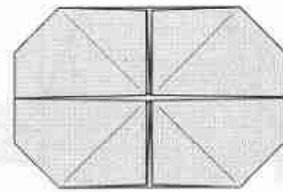
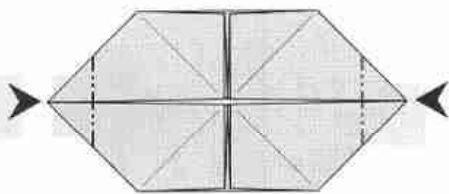
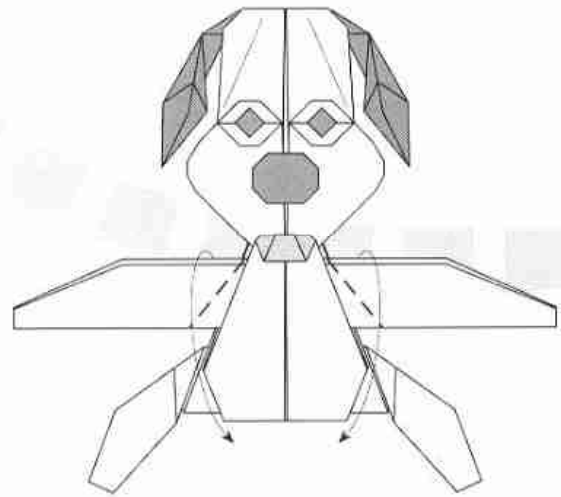
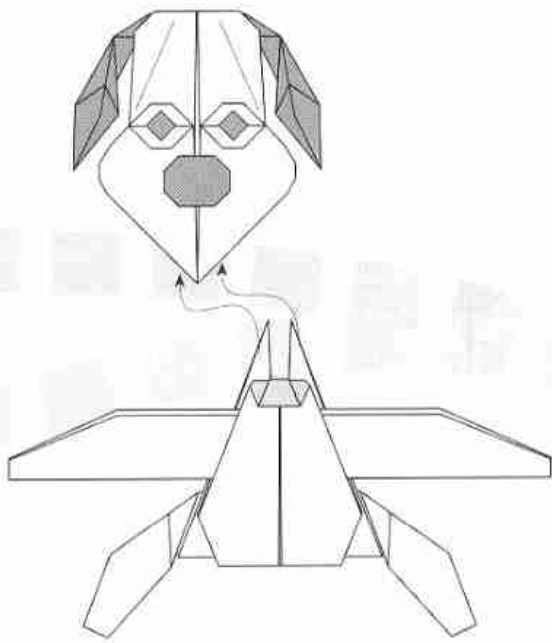

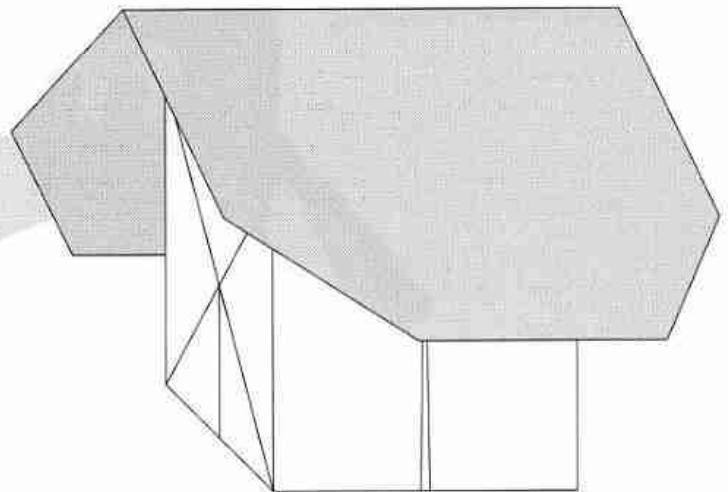
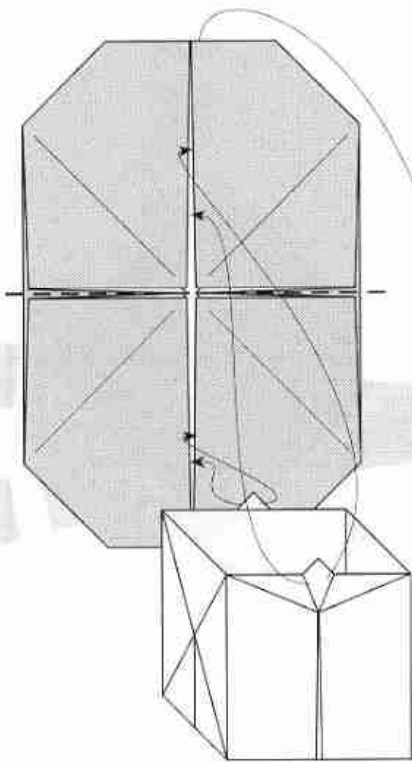
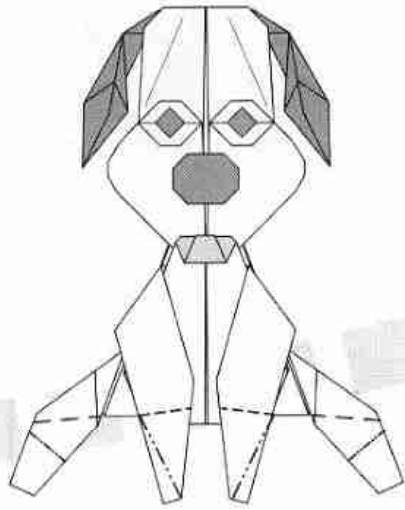

Página (Desarr.)	Pieza nº	Cantidad	Porción	COLORES		Tamaño original	Tamaño 3/10	Tamaño 2/5	Tamaño 3/5
				Anverso	Reverso	10 cm alto	3 cm alto	4 cm alto	6 cm alto
						Lado (cm) =	Lado (cm) =	Lado (cm) =	Lado (cm) =
143	1	1	Cabeza	Neutro	Azul	20	6	8	12
143	2	1	Cara	Azul	Verde	10	3	4	6
143	3	1	Ojos	Negro	Bianco	5	1,5	2	3
144	4	1	Nariz/Boca	Neutro	Negro	1,7	0,51	0,68	1,02
144	5	2	Piernas	Rojo	Negro	10	3	4	6
145	6	2	Brazos	Bianco	Negro	10	3	4	6
145	7	2	Manos	Neutro	Amarillo	5	1,5	2	3
147	8	2	Cejas	Neutro	Negro	2,5	0,75	1	1,5

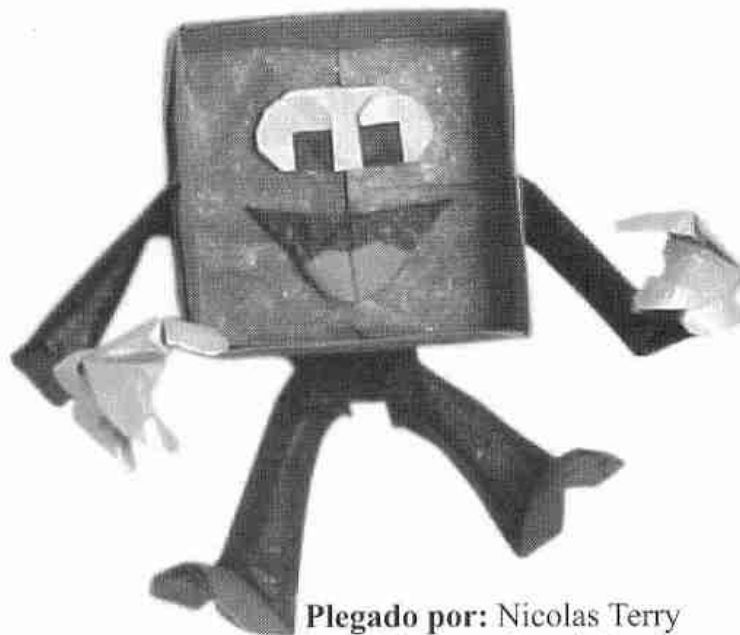

Plegado por: Nicolas Terry
<http://design.origami.free.fr>

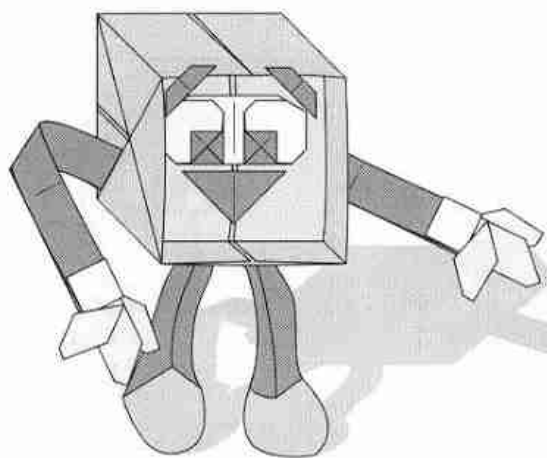

Utilizando las medidas recomendadas, se obtiene un modelo final de 10 cms.

Autor:	Halle
Nivel de dificultad:	Baja
Número de piezas:	12
Forma de las piezas:	Cuadrados

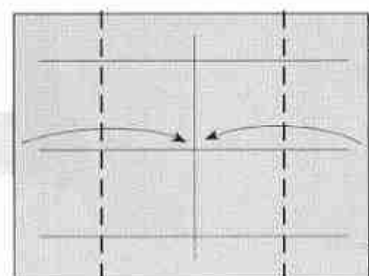
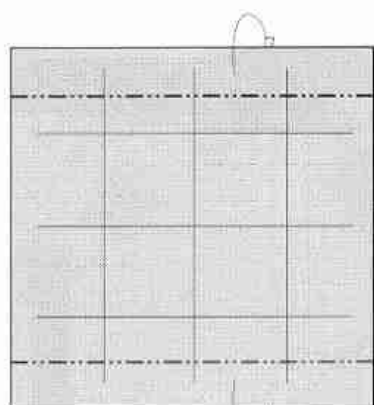
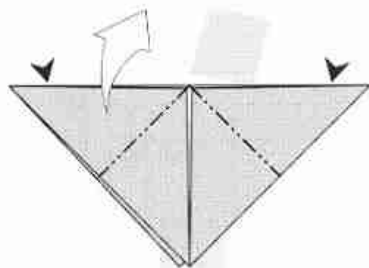
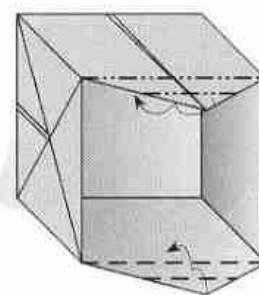
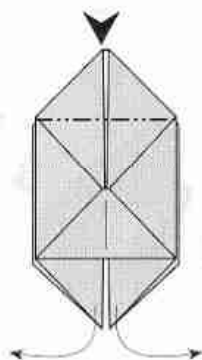
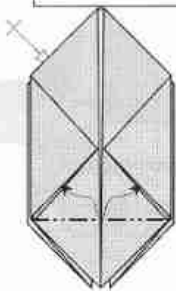
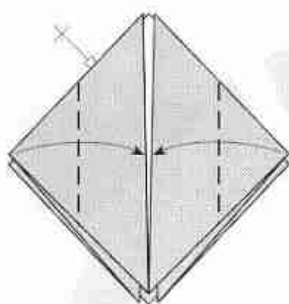

● Azul Verde 10 cm 10 cm

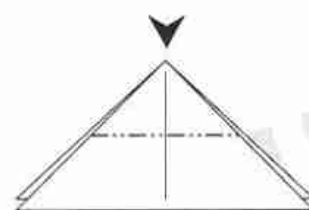
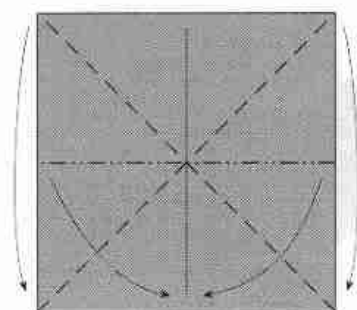
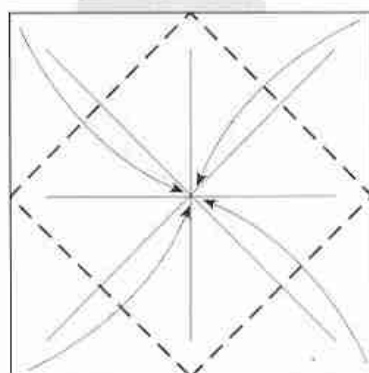
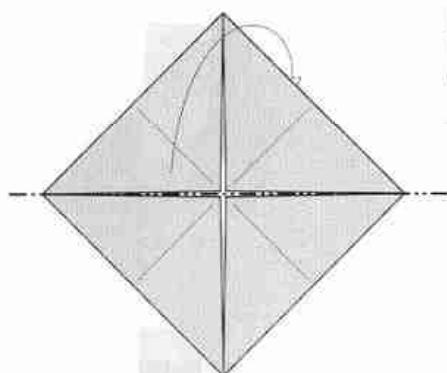

● Negro Blanco 5 cm 5 cm

● Azul 20 cm 20 cm



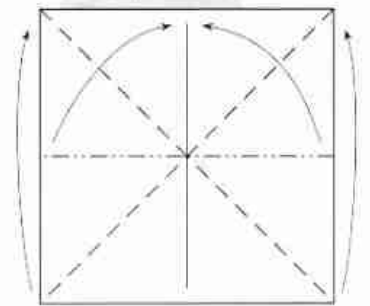
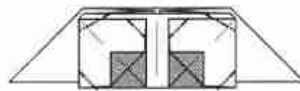
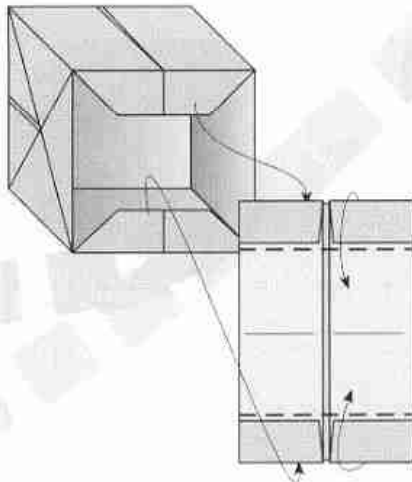
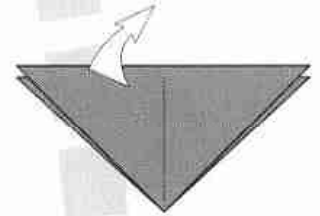
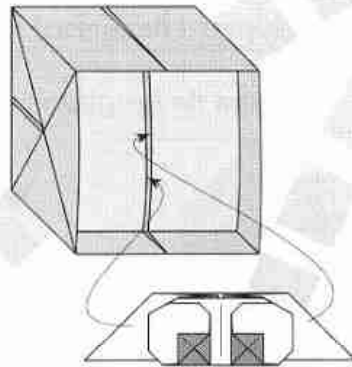
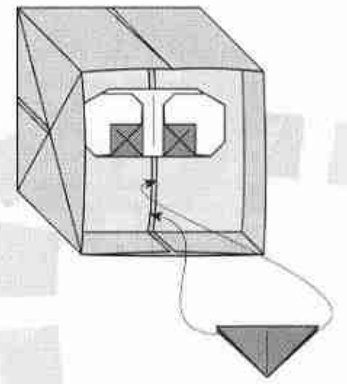

● Negro

■ 1,7 cm
1,7 cm

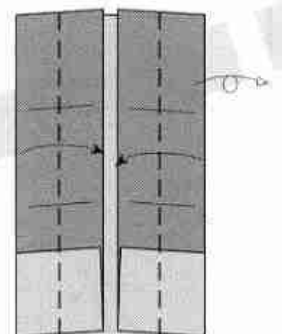
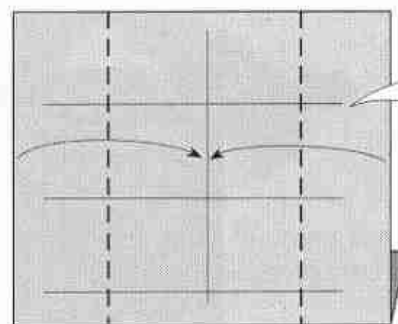
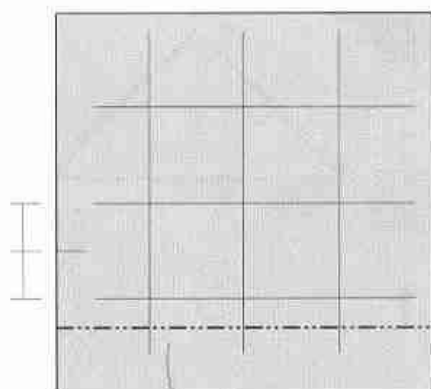
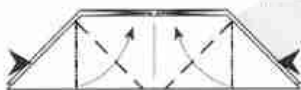

● Negro
● Rojo

■ 10 cm
10 cm





La boca admite muchas posibilidades, dependiendo de la base de que partamos y con muy pocos plegados podemos obtener gran variedad de expresiones

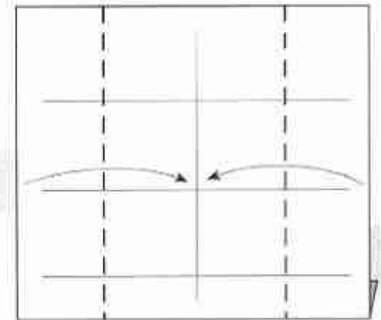
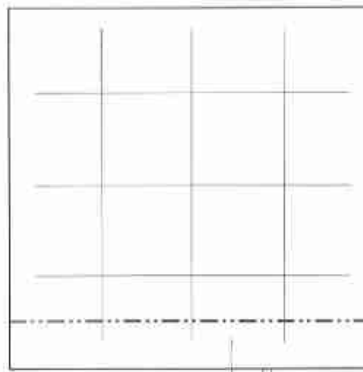
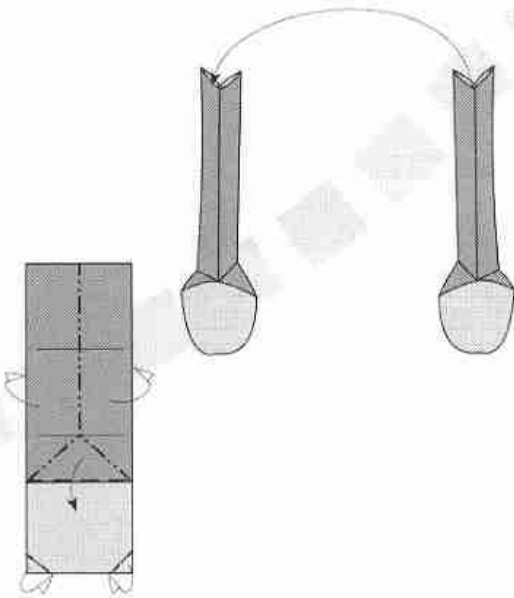
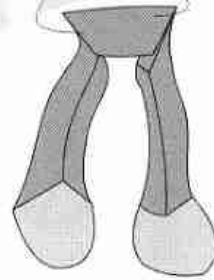
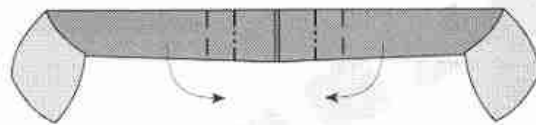
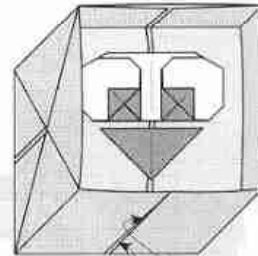
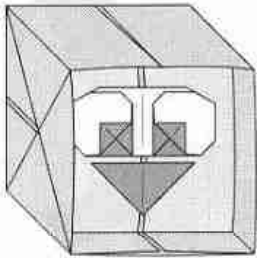
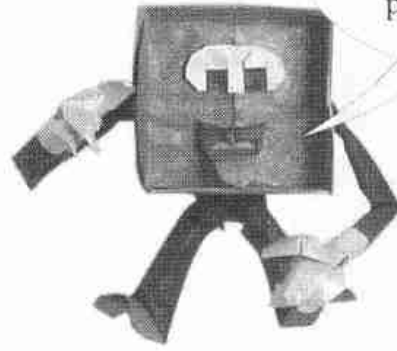

● Blanco
● Negro

□ 10 cm
□ 10 cm

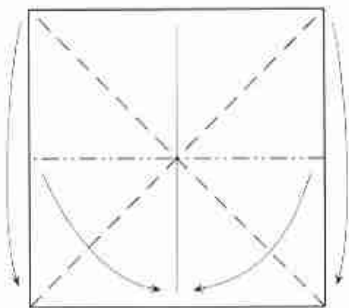

● Amarillo

□ 5 cm
□ 5 cm

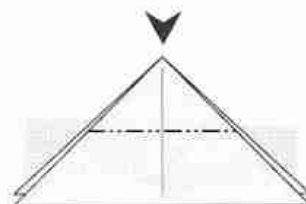
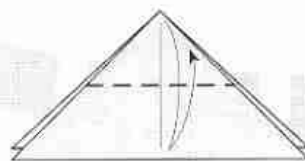

Las muchas ranuras que tiene "Webby", nos facilita la unión de los brazos con el cuerpo, permitiendonos además una gran variedad de posiciones para estos e incluso podemos ponerle sombrero.

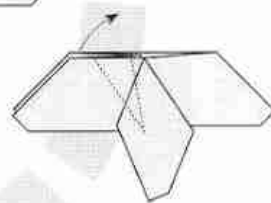
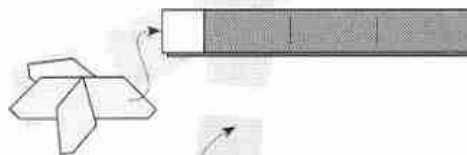
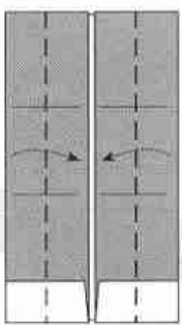
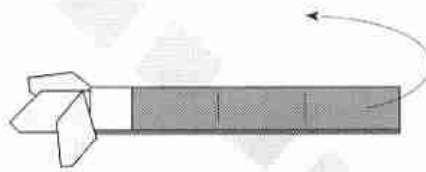
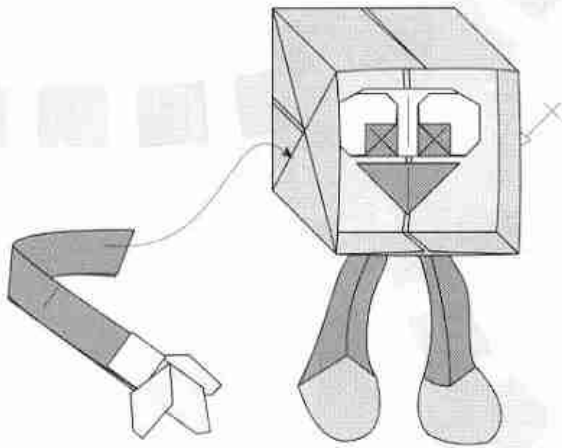
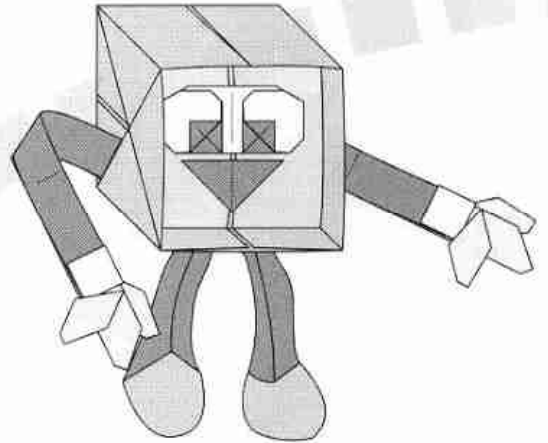
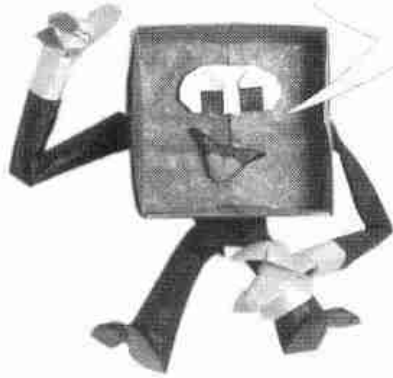
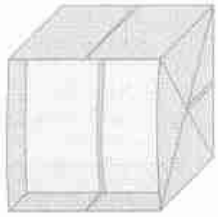

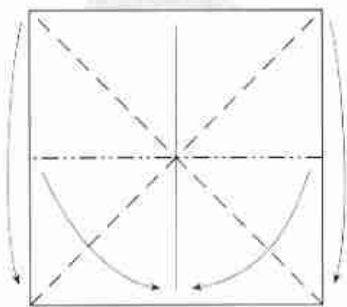
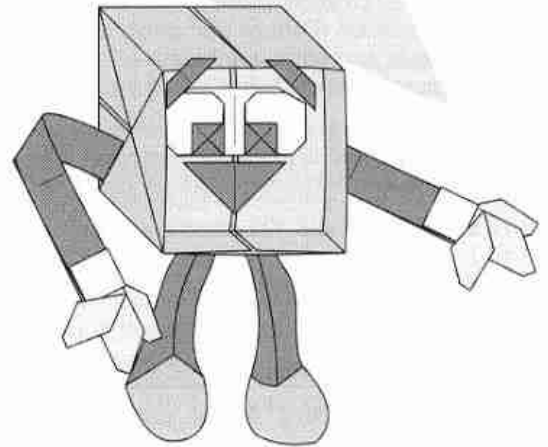
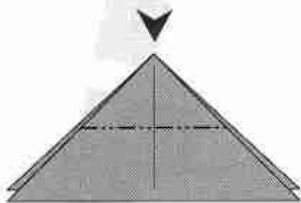
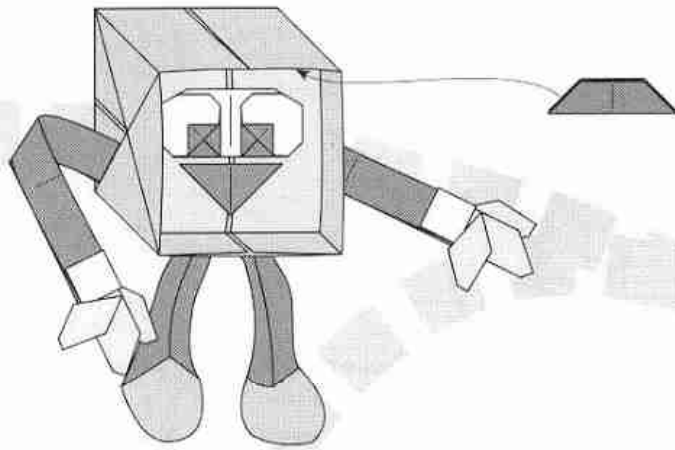

● Negro

■ 2.5 cm
2.5 cm

LA NAISSANCE D'UN CARTOON

Par Halle

Mes sincères remerciements à Alfredo Pérez Jiménez pour ses conseils et son assistance dans l'écriture de cet article, ainsi qu'à Anibal Voyer pour les illustrations.

- I) **INTRODUCTION**
- II) **PROCESSUS DE CREATION**
- III) **CONCLUSION**



I) **INTRODUCTION**

Depuis qu'est né mon tout premier Cartoon en origami, une version personnelle de la Panthère Rose, On m'a souvent demandé d'expliquer comment je faisais, qu'elles étaient mes techniques de création.

Dans cet article, je vais tenter de vous expliquer mon "mode opératoire", mais cela ne veut pas dire que je le suis mot à mot. Absolument pas. Ce qu'il y a de vraiment fascinant dans le monde de la création, c'est bien la liberté de l'artiste qui ne suit pas des règles établies mais qui est guidé par son intuition et son inspiration; c'est seulement ainsi, je crois, que l'on peut trouver son propre style ...du moins, c'est ce que j'essaie.

Je considère la "création", hormis pour les génies, comme un processus qui ne peut s'acquérir en un seul jour. Personnellement, je pense que c'est d'abord une question de temps avec un désir profond de faire ses propres modèles. Il est difficile d'expliquer la sensation que cela produit. Je sais seulement que cela m'enveloppe, le temps défile sans que je ne m'en rende compte; et par-dessus tout, je me sens détendu.

J'ai passé beaucoup de temps à plier des modèles d'autres créateurs avant que naisse ce désir de créer. Et quand celui-ci est apparu, je me suis demandé comment je pourrais créer quelque chose qui différerait des modèles classiques tels que les dinosaures, les insectes et autres animaux.

Avec cette idée en tête, j'ai commencé par un premier pas important : la maîtrise des bases traditionnelles. Et puis, comme le dit Juan Gimeno, j'ai "lu" beaucoup d'origami, ce qui consiste, en fait, à examiner avec attention les diagrammes sans même faire un simple pli, juste pour enregistrer mentalement le processus de pliage et de construction du modèle.

Mais sans plus attendre, passons au sujet principal de cet article.

II) **LE PROCESSUS DE CREATION**

Lors de la création d'un nouveau modèle, je suis les points décrits ci-dessous:



1) Tout d'abord, je détermine ce que je veux créer. Puis, je dessine une image du modèle, ce qui met en évidence les parties fondamentales et tous les petits détails qui font sa personnalité et lui donnent vie

2) Une fois que le modèle est dessiné, je réfléchis à toutes les pièces que je dois utiliser pour le construire. Je les associe alors chacune avec une base traditionnelle et j'élimine tous les détails superflus.

3) Ayant déterminé ces pièces, je commence à les travailler, commençant par celle que je considère comme la plus dure et qui définit souvent l'"âme" du personnage..

4) Durant la construction, je détermine les tailles relatives des carrés de papier afin que toutes les pièces soient dans des proportions adéquates.

5) Finalement, j'analyse les pièces et j'essaie de les assembler entre elles.

Pour faire le dessin initial, j'utilise une technique de dessin basé sur les cercles et ellipses; je crée un petit brouillon, par exemple celui de l'adorable Titi.

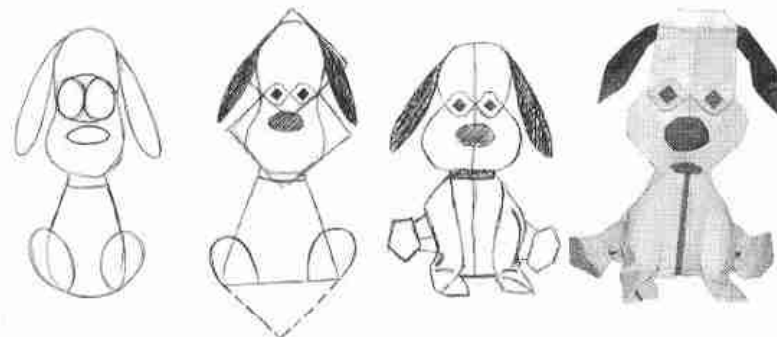

Cette technique de dessin est très simple et permet beaucoup de possibilités.

Après cela, j'affine le dessin initial en ajoutant plus de détails jusqu'à ce que cela ressemble à ce que je veux créer.

La partie la plus importante du modèle est habituellement la tête. Obtenir une expression qui transmette la douceur, la gentillesse, l'envie de nous faire



rire ... C'est ce que je considère comme le plus important.

Durant cette période créative, il peut arriver qu'une certaine combinaison de pièces, de couleurs ou de proportions me suggère plus d'un personnage. Prenez l'exemple du visage d'Homer Simpson et un premier brouillon de l'énigmatique Kenny

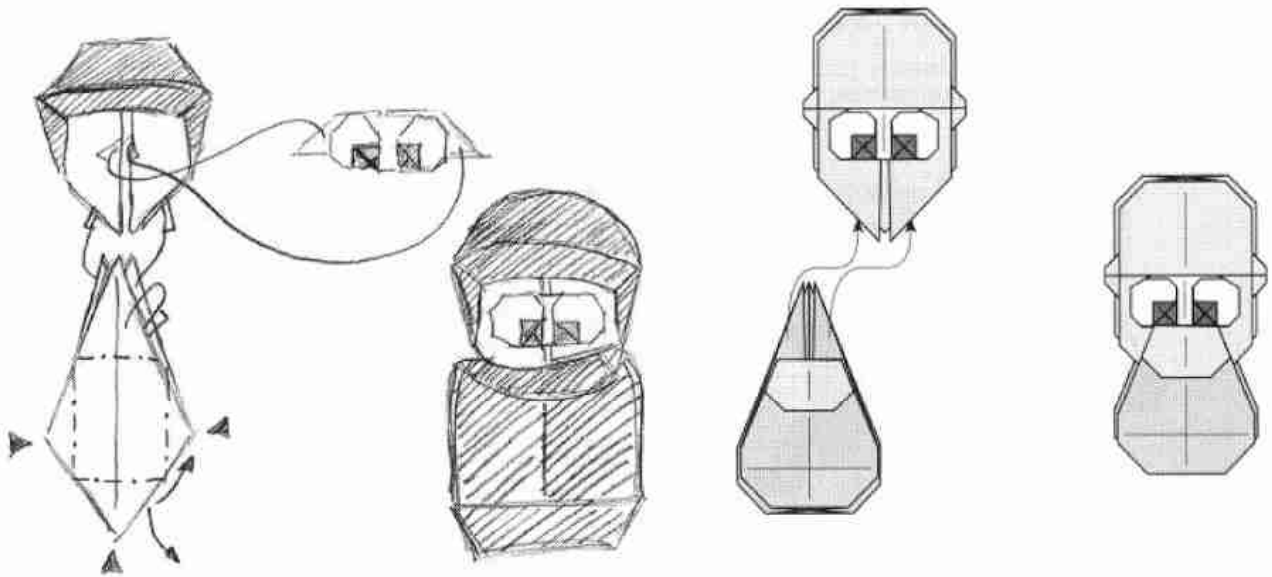

Ces deux personnages utilisent des pièces identiques : une base préliminaire et une base de l'oiseau, assemblées de la même façon. Mais la combinaison des couleurs et les différentes proportions nous donnent des résultats très différents.

Une tête a normalement deux oreilles, deux yeux, une base pour le visage ... Ainsi, beaucoup trop de points doivent être créés juste avec une simple base. Je dois alors "sacrifier" certaines parties de la tête pour les réaliser avec un autre carré... C'est une question d'imagination, d'inspiration et de chance ...

Quelquefois, je plie les bases traditionnelles et je joue avec elles comme avec un puzzle. Le simple fait de les arranger entre elles me donne un bon résultat comme par exemple la tête de cette petite souris, qui a été créée avec un mélange de toutes les bases simples (base préliminaire, base de la bombe à eau, base de l'oiseau)

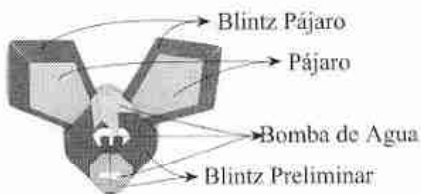

Je tiens à souligner que j'essaie toujours de me laisser conduire par mon intuition et par tout ce que mon imagination m'apporte, sans restriction.

Pour le corps lui-même, ma base préférée est celle de l'oiseau avec un Blintz parce qu'elle laisse une fente Eau milieu de la pièce et me permet ainsi d'assembler d'autres pièces.

Avec cette base, il est aussi possible de faire un changement de couleur.

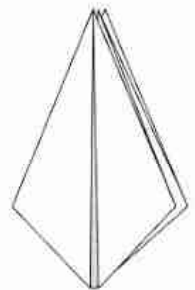

Je dois enfin faire attention au modèle et, en fonction de sa constitution, il est facile de créer un corps robuste ou plus stylisé.

Donner du volume à un modèle est quelquefois facile et d'autres fois plus difficile. Une simple superposition de lignes verticales et horizontales dans l'espace m'aide beaucoup. Enfin, la création d'articulations pour les membres conduit à un meilleur réalisme.

J'en suis venu à la conclusion que, habituellement, il est préférable de simuler certaines parties du corps plutôt que

d'essayer de créer de nouvelles pièces. Par exemple, les doigts, en certaines occasions, sont mieux rendus avec de légers plis. Je les fais avec l'aide d'une pince à épiler suivant le conseil que m'a donné mon ami Anibal Voyer.

Avec l'utilisation de différentes pièces, j'ai l'avantage de pouvoir donner plus de couleurs à mes créations, ce qui leur donne un meilleur "look" et un aspect plus sympa.

Mais je n'abuse pas cet avantage. Si j'utilise une nouvelle pièce, c'est qu'auparavant, je me suis creusé la tête et que je n'ai pas trouvé comment créer la partie du

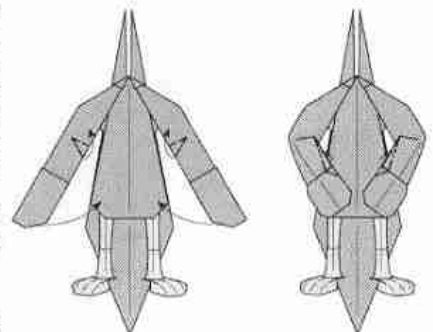

modèle voulue avec les couleurs et les pièces déjà en place

Pour expliquer ceci, voici un exemple récent :

D'abord, je dessine le personnage avec tous ses détails.

Faire une version simple de Kenny du dessin animé South Park, est facile et quatre pièces sont plus que suffisantes.

Je peux compliquer un peu le modèle en ajoutant les mains sans utiliser de pièces supplémentaires.

Si je veux être encore plus réaliste, je peux ajouter une étape supplémentaire: en créant deux nouvelles pièces et en modifiant les couleurs des pièces initiales, j'obtiens les yeux et un capuchon plus détaillé .

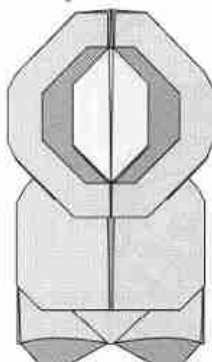

III) CONCLUSION

En dépit des nombreuses années passées à créer des cartoons, je n'ai jamais arrêté d'étudier l'origami. En effet, cela me suggère des méthodes que j'applique alors à certains modèles que je n'ai pas terminés faute d'inspiration.

En parlant d'inspiration, lorsque je ne peux plus créer quoique ce soit, je ne désespère pas. J'arrête tout simplement pendant quelques jours. Je crois que l'inconscient prend la relève car après cette période, je reprends le modèle avec plaisir et, de manière surprenante, je trouve une nouvelle voie, je résous un problème ou encore une nouvelle base apparaît et me suggère un nouveau cartoon.

J'essaie de capter l'âme du personnage; je laisse de côté les aspects qui n'amènent pas de vie et qui quelquefois ralentissent ma créativité.

Les critiques ne me découragent pas pour continuer de créer, même les plus dures qui habituellement proviennent de ma propre famille. De plus, une critique constructive m'aide à me surpasser.

Aujourd'hui, je crois, sans modestie, que je suis capable de continuer à créer d'autres cartoons, bien que j'ai conscience que je dois franchir une nouvelle étape: créer moi-même un personnage, avec sa propre personnalité, qui sera à la hauteur de ces magnifiques et universels cartoons qui me remplissent de joie, et de leurs créateurs que j'admire et respecte sincèrement.

Artículo traducido por: Nicolas Terry

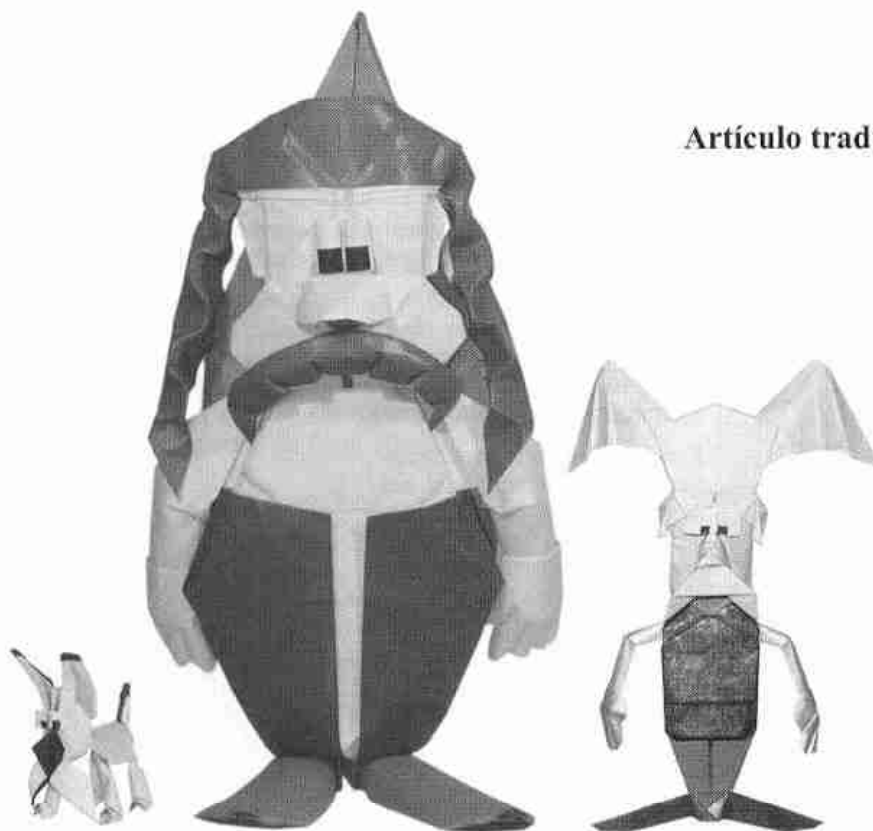

CREANDO CARTOONS

By Halle

Mi más sincero agradecimiento a Alfredo Pérez Jiménez por sus consejos y matizaciones a la hora de redactar este artículo, y a José Aníbal Voyer por las ilustraciones que lo acompañan.

- I) INTRODUZIONE
- II) PROCESSO DELLA CREAZIONE
- III) ASPETTI FINALI



I) INTRODUZIONE

Sin dalla nascita del mio primissimo cartoon origami, una versione speciale della Pantera Rosa, mi è stato chiesto spesso di spiegare come e quale sia la mia tecnica creativa.

In questo articolo svelerò il mio "modus operandi" ma non significa che lo seguo parola per parola. Assolutamente no, il mio motto è, che se c'è qualcosa di affascinante nel favoloso mondo della creazione, è il fatto che il creatore ha la libertà di non seguire nessun ruolo ma di essere guidato solo dall'intuito e dall'ispirazione; solo in seguito uno può cercare il proprio stile... almeno io tento di fare ciò.

Io considero che il "creare", eccetto forse per i geni, sia un processo che non si può acquisire in un solo giorno. Personalmente penso che sia una questione di tempo e che il desiderio di inventare modelli venga dal di dentro. E' difficile spiegare il sentimento che produce, io so solo che mi circonda, il tempo vola e io non me ne rendo conto; e soprattutto mi rilasso.

Ho trascorso molto tempo piegando modelli di altri creatori prima che nascesse questo desiderio e quando ciò è successo, ho iniziato a domandarmi come avrei potuto iniziare a creare qualcosa di diverso dai soliti classici modelli come dinosauri, insetti, animali, ecc.

Per arrivare a questo io avevo già fatto un grande passo: mi ero impadronito delle conoscenze delle basi tradizionali ed inoltre, come dice J. Gimeno, avevo "letto" molti origami, il che consiste nell'esaminare accuratamente i diagrammi anche senza fare una singola piega e nel "ricalcare" mentalmente il processo per la costruzione del modello.

Ma adesso voglio essere diretto ed arrivare alla parte principale dell'articolo.

II) PROCESSO DELLA CREAZIONE

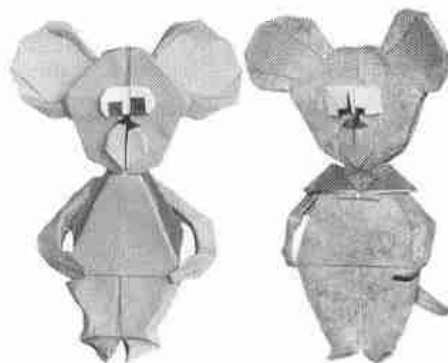

Nel processo per la creazione dei nuovi modelli, io seguo i seguenti parametri:

- 1) Determino il principio di cosa voglio creare e disegno un'immagine del modello dando enfasi alle parti principali e ad ogni tipo di dettaglio che definisce la personalità o dà vita al disegno.
- 2) Una volta che il modello è disegnato penso a quanti pezzi sono necessari per costruirlo. Li associo alle basi tradizionali e cancello tutti i dettagli che possono essere considerati superficiali.
- 3) Avendo determinato i pezzi, inizio a lavorare con loro, iniziando con quello che reputo il più difficile e che per coincidenza è quello che definisce l'anima del modello.

4) Mentre proseguo nella costruzione determino le relative misure dei quadrati di carta in modo che le singole parti siano proporzionate.

5) Infine analizzo le parti e tento di unirle assieme.

Per fare il disegno iniziale uso la tecnica di disegnare cerchi ed ellissi; creo un piccolo abbozzo, nell'esempio Tweety.

Questa tecnica di disegno è semplicissima e offre molte possibilità.

Poi rifinisco il disegno iniziale con più dettagli fino a rendere evidente ciò che voglio creare.

La parte più importante del modello è spesso il volto. Deve avere un'espressione che trasmette dolcezza, gentilezza, che sorride da....

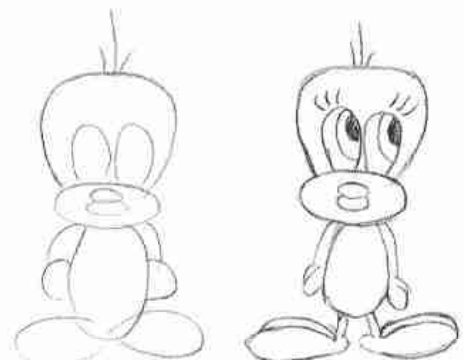

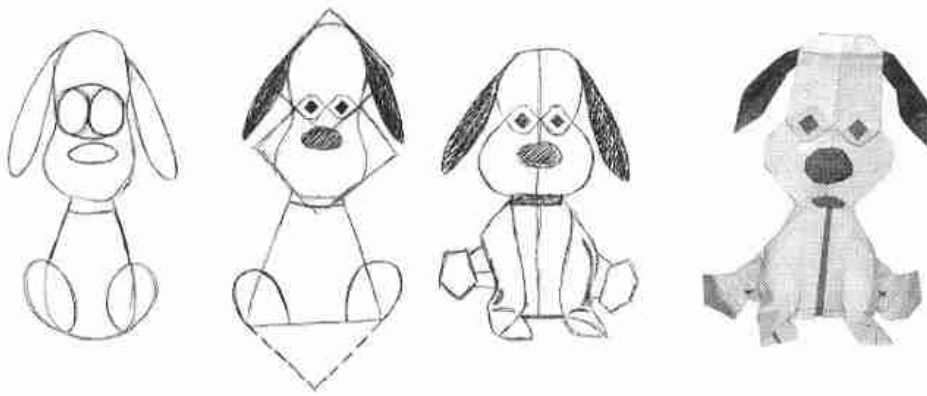

Considero questo importantissimo.

Mentre si sta creando può essere che la combinazione dei pezzi, dei colori e delle proporzioni suggeriscano più di una caricatura.

Nell'esempio ci sono i volti di Homer Simpson e un primo abbozzo dell'enigmatico Kenny.

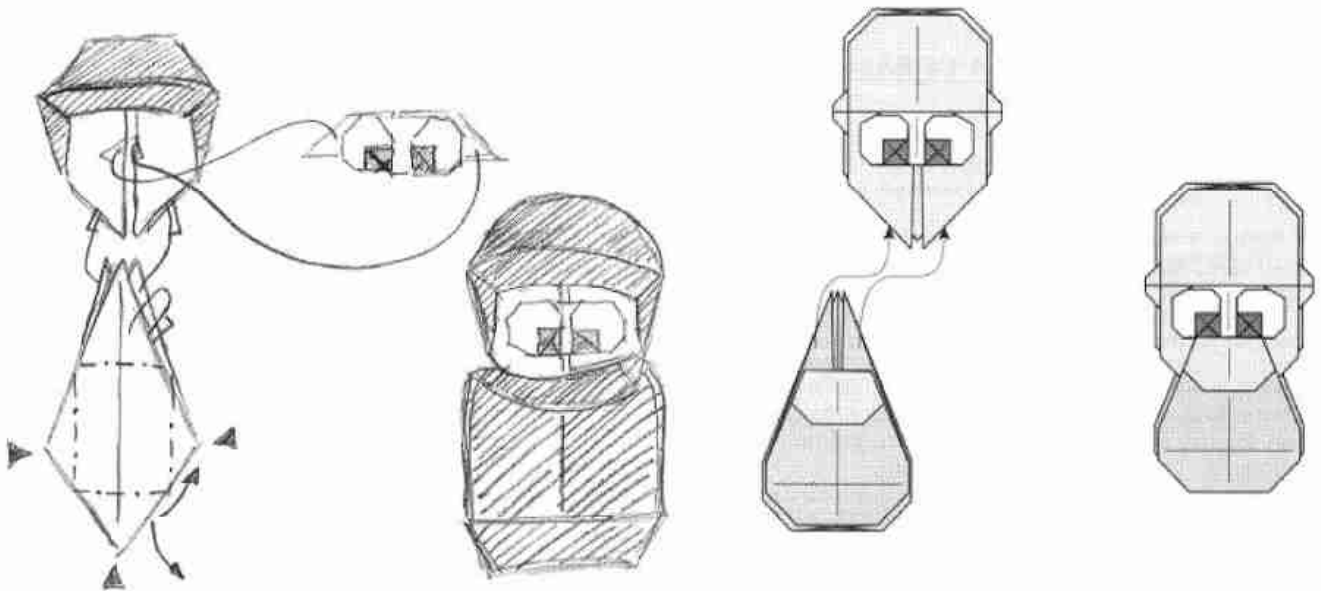

Entrambi sono basati su pezzi identici, una base preliminare e una base della gru unite nello stesso modo, ma con diverse combinazioni di colori e diverse proporzioni si ottengono risultati nettamente differenti.

La testa di norma ha due orecchie, due occhi, la base per il volto... questo significa che troppi punti sono necessari per crearla solo con una semplice base. Devo "sacrificare" alcune parti della testa per ottenerle da altri quadrati... E' una questione di immaginazione, intuizione e fortuna.

Talvolta piego le basi tradizionali e gioco con loro come in un puzzle. Il semplice atto di sistemarle mi dà un buon risultato come nel volto di questo piccolo topo che è creato da una miscela di quasi tutte le basi (preliminare, water bomb, base della gru).

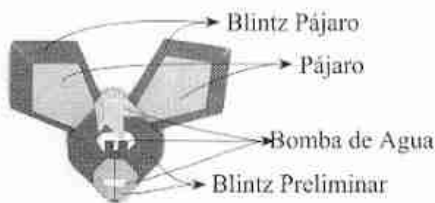

Con ciò voglio mettere in chiaro che quello che voglio sempre fare è lasciarmi prendere dall'intuizione e da qualunque cosa la mia immaginazione mi dica, senza restrizione.

Per il corpo la mia base preferita è la Bird Blitz perché possiede una fessura che corre lungo tutto il futuro giunzione specialmente con i margini.

L'uso di questa base mi permette spesso di fare un cambio colore.

Devo fare molta attenzione al modello e in base a come è composto è facile renderlo più robusto o stilizzato.

Dare volume al modello alcune volte è semplice altre volte più complesso.

La semplice sistemazione dei livelli orizzontali e verticali nello spazio aiuta molto. Dare forma alle giunzioni aumenta il realismo del modello.

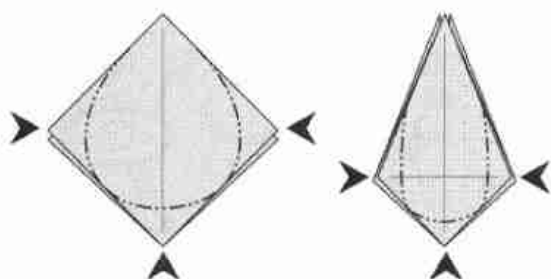

Sono arrivato alla conclusione che di solito è meglio simulare certe parti del corpo piuttosto che creare ulteriori pezzi per esse. Per esempio le dita appaiono meglio se rese da una leggera piega invece di crearle una per una.

Per fare queste pieghe uso piccole pinzette, consiglio che mi ha dato il mio amico Anibal Voyer.

Nell'uso dei singoli pezzi io ho l'ulteriore vantaggio di saper abbinare più colori, cosa che rende il modello accattivante.

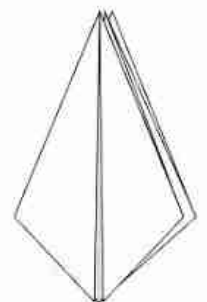

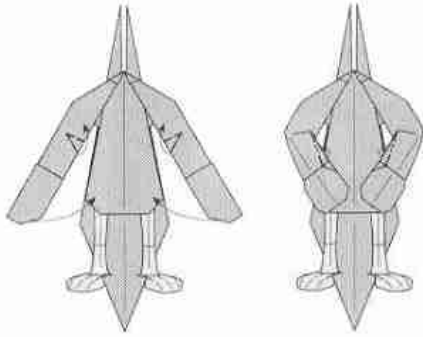

Ma non è necessario arrivare agli estremi. Se mi rendo conto che è impossibile rendere compatibili colori o parti del modello allora decido di usare un nuovo pezzo.

Per spiegare la situazione uso un esempio con tutti i dettagli.

Fare una versione semplice di Kenny del Polo Sud è molto semplice e quattro pezzi sono più che sufficienti. Uso semplicemente basi preliminari.

Posso renderlo un po' più complesso aggiungendo le mani senza bisogno di altri pezzi.

Se voglio renderlo più realistico posso aggiungere un passo in più e dalla creazione di due nuovi pezzi a cui viene cambiato il colore ottengo due occhi espressivi

ed il dettaglio del cappuccio sopra la testa.

III) ASPETTI FINALI

Dopo aver trascorso parecchi anni creando modelli non ho mai smesso di leggere libri di origami.

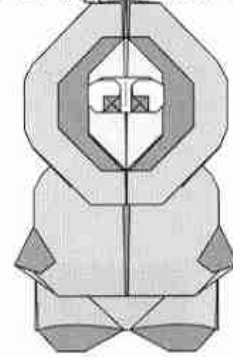
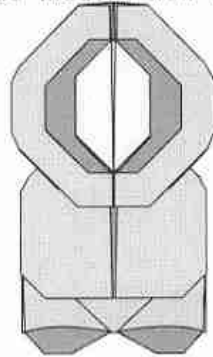

Leggere mi suggerisce metodi da applicare a quei modelli che non avevo finito perché mi mancava l'ispirazione.

A proposito d'ispirazione, quando non riesco a creare qualcosa non dispero. Quello che faccio è abbandonare il modello per qualche giorno. Credo che il subconscio continui a lavorare perché dopo poco tempo ritorno al modello con piacere e le soluzioni appaiono come per miracolo: trovo un nuovo metodo, risolvo un problema, una nuova base mi suggerisce una nuova caricatura.

Cerco di catturare l'anima del modello tralasciando gli aspetti che non lo rendono vivo ed in qualche caso ritardo il mio lavoro.

Non permetto a me stesso di perdere il desiderio di creare a causa delle critiche, anche se le peggiori vengono dalla mia stessa famiglia. Inoltre una buona critica costruttiva mi ha aiutato a fare meglio.

Oggi, io credo, senza modestia, di essere capace di continuare a "ricreare" con tecniche origami altri simpatici cartoons, essendo conscio di non aver raggiunto il livello più importante della creatività: creare dei personaggi miei con proprie personalità che siano belli come queste creazioni universali e magnifiche i cui creatori rispetto ed ammiro.

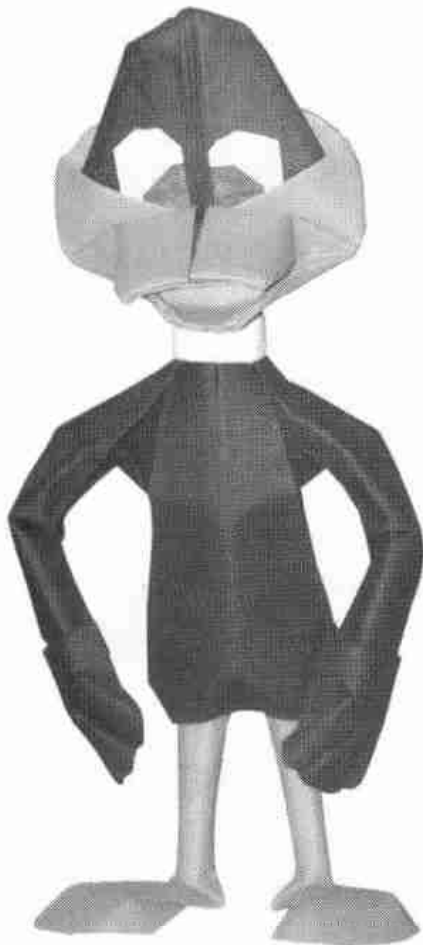

Artículo traducido por: Dario Motterle

