

CARTOON

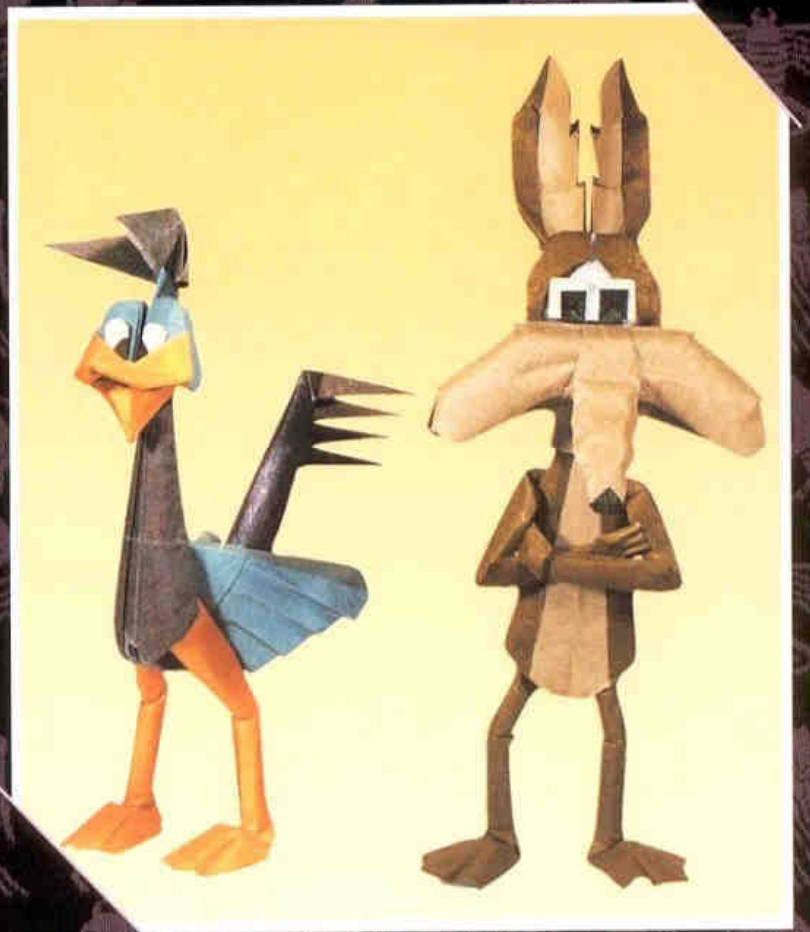

ORIGAMI

By Halle



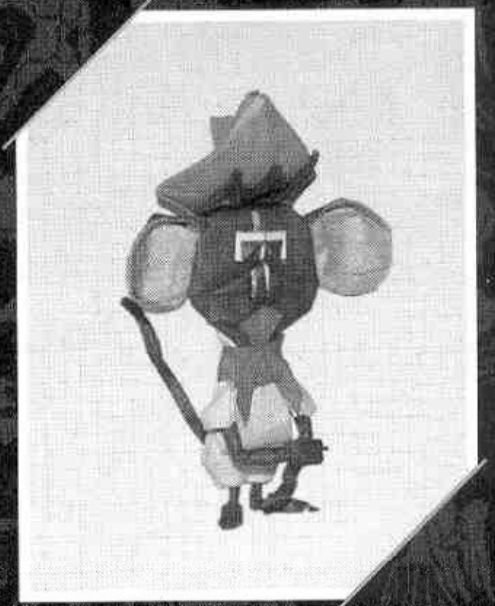
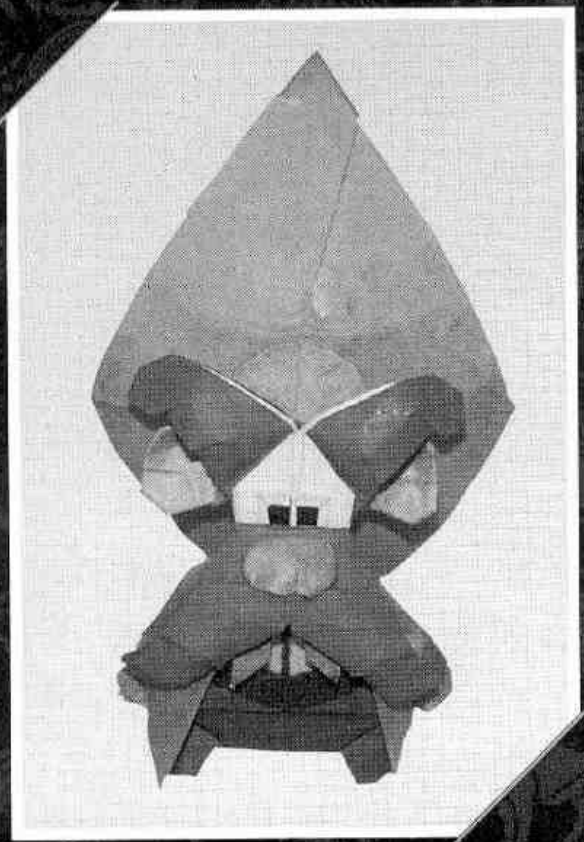
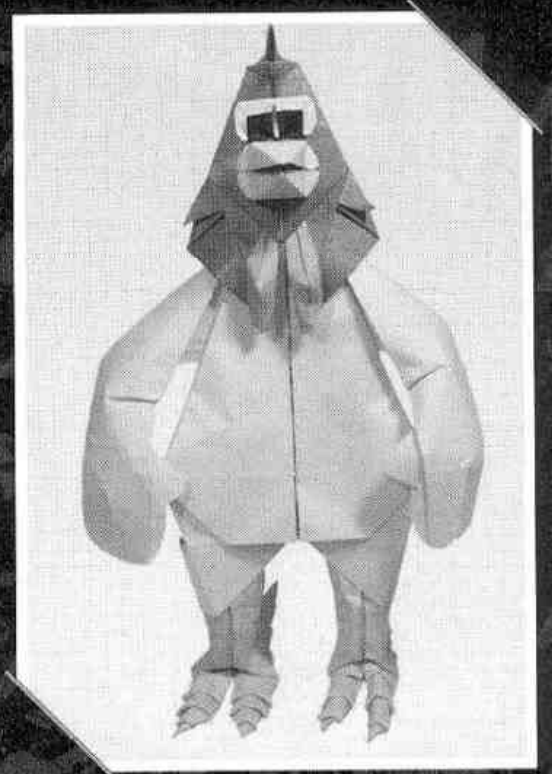

CARTOON

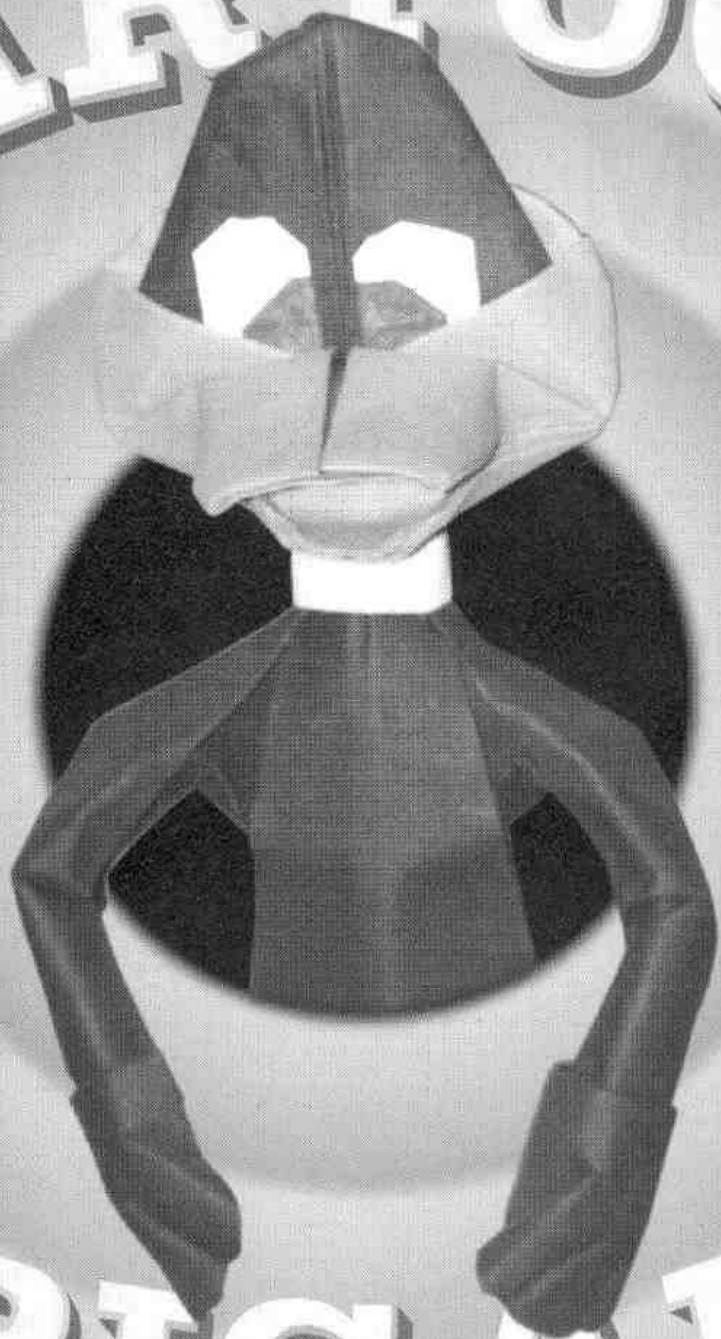

ORIGAMI

By Halle

Autor
Fecha de edición
Edición
Modelos diagramados por
Recortados de fotografías

Halle
Septiembre 2001
500 ejemplares
J.A.V.I.
Alfredo P.

Todos los modelos han sido plegados por **J.A.V.I.**
excepto el de la página 23 realizado por **J. Crowley**

CARTOON ORIGAMI

*By
Halle*

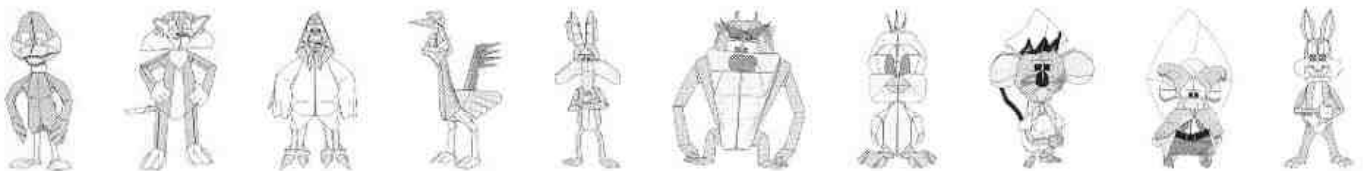

ÍNDICE

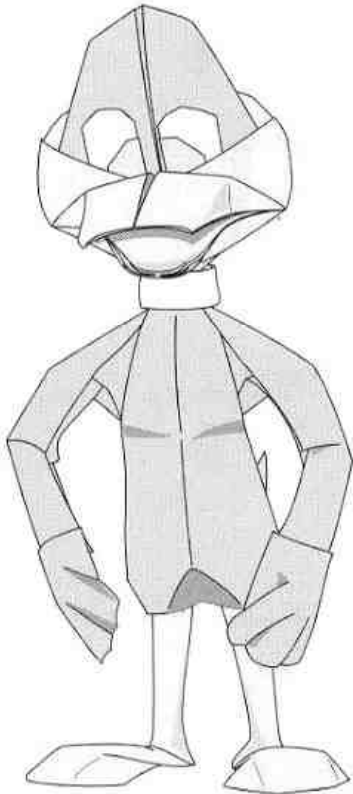

PÁGINA 15

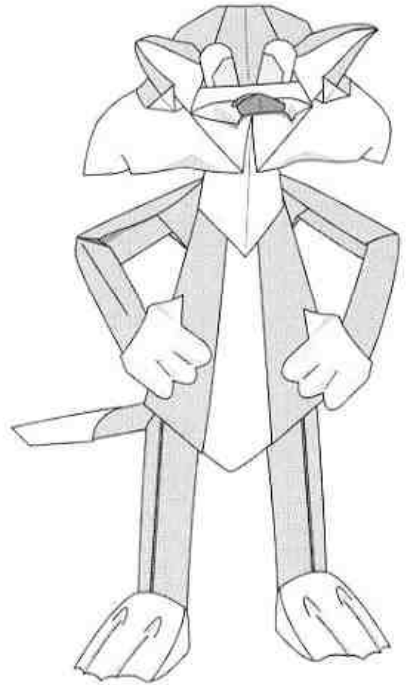

PÁGINA 23



PÁGINA 31



PÁGINA 41

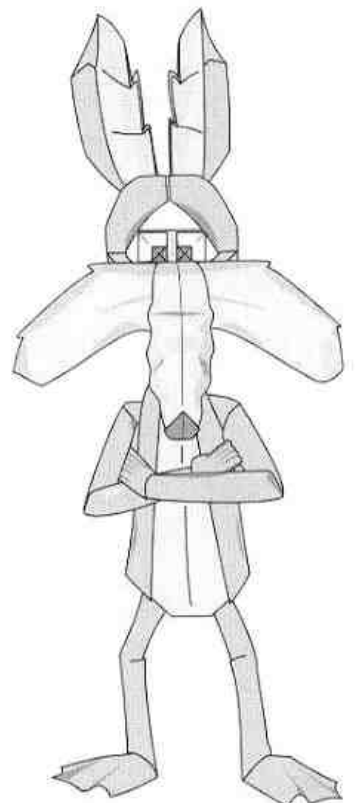

PÁGINA 51

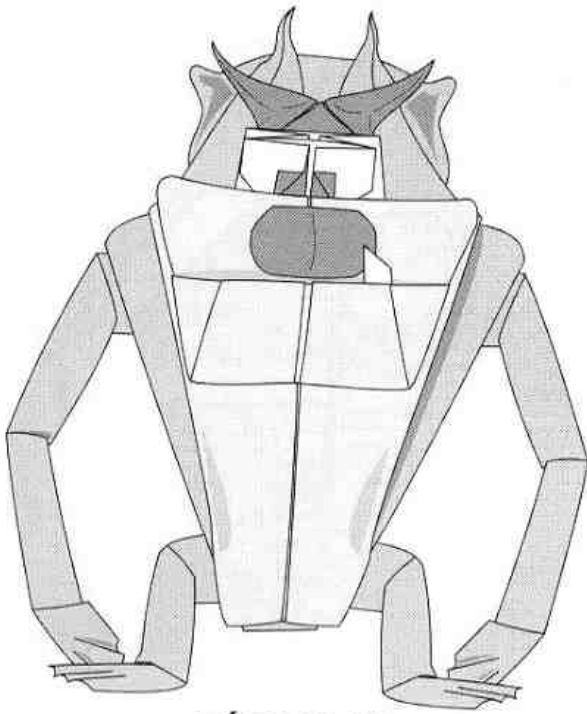

PÁGINA 61

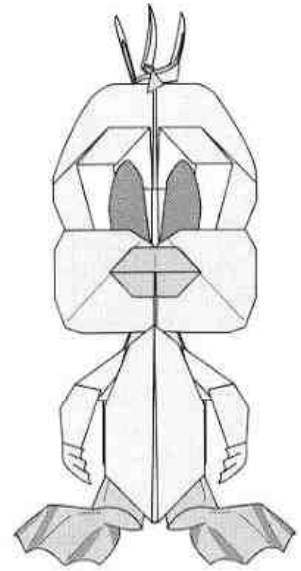

PÁGINA 71



PÁGINA 83

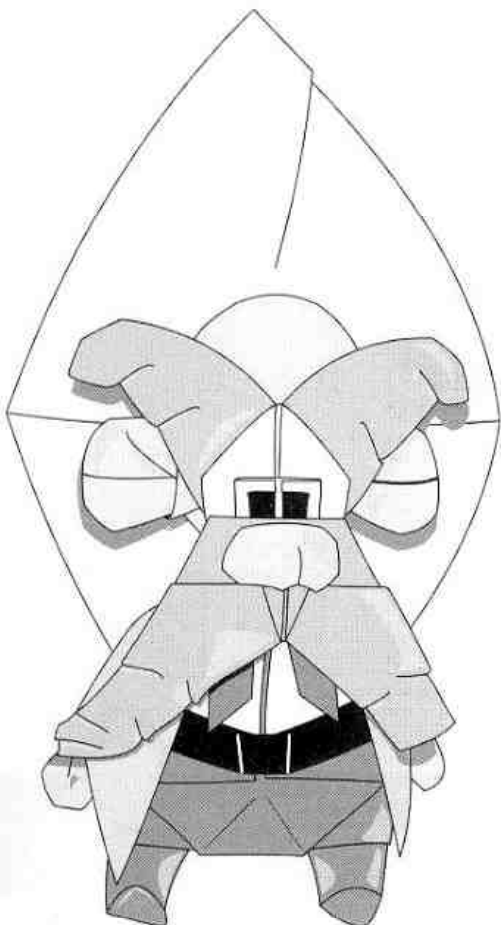

PÁGINA 95

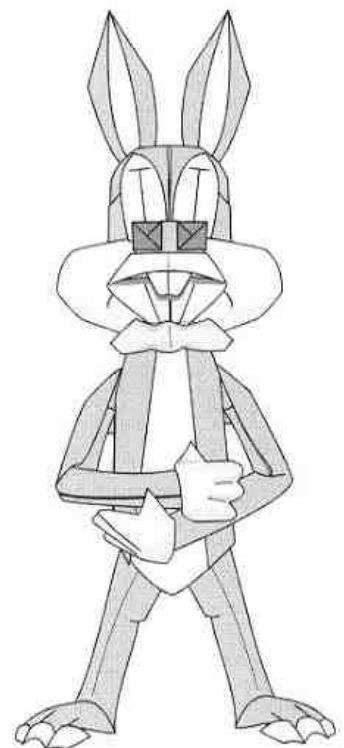

PÁGINA 107

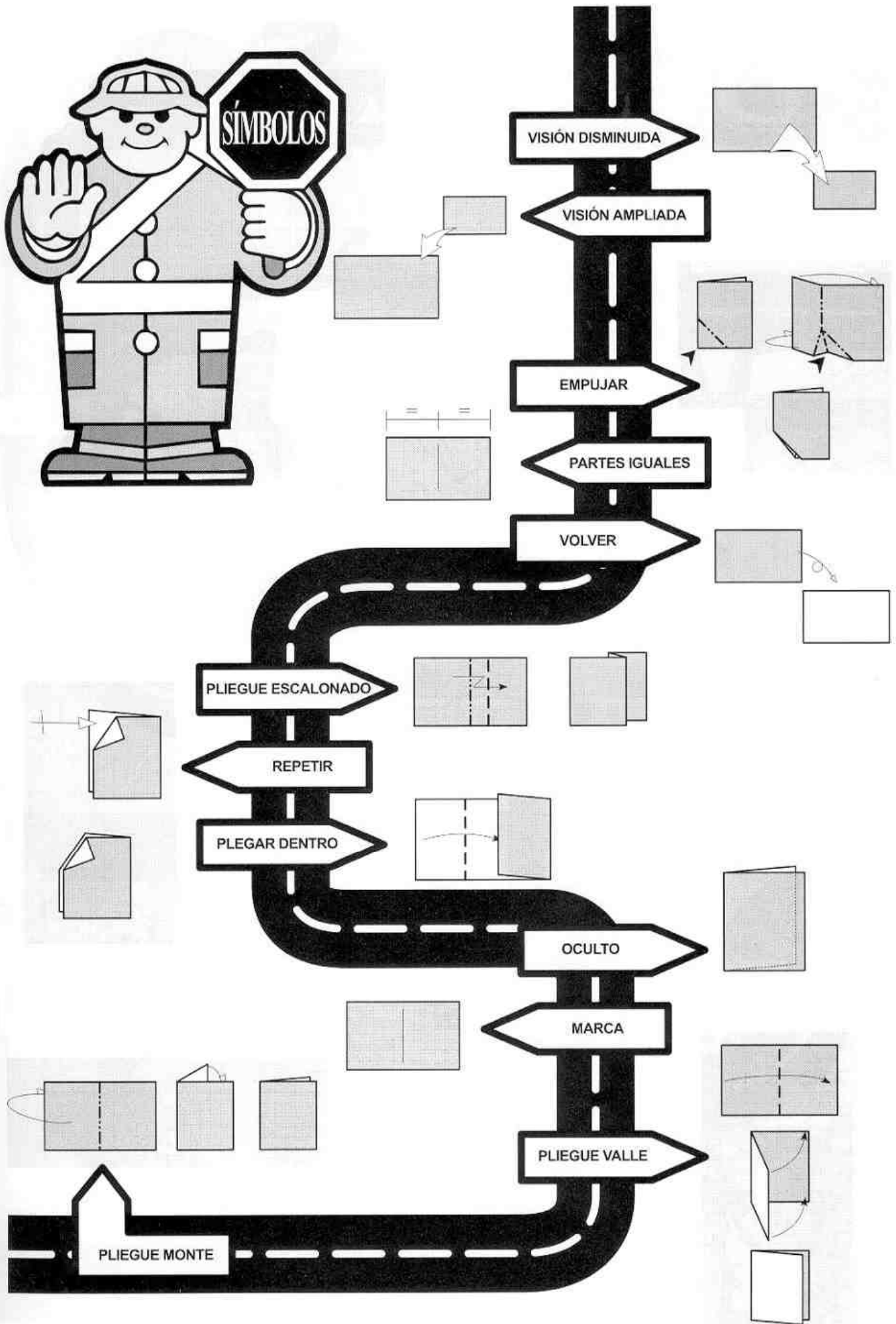

BASES

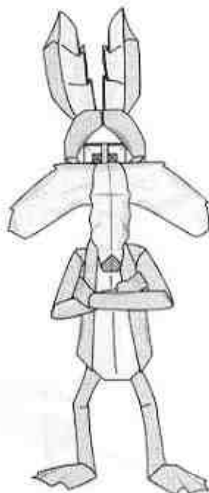
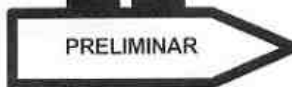
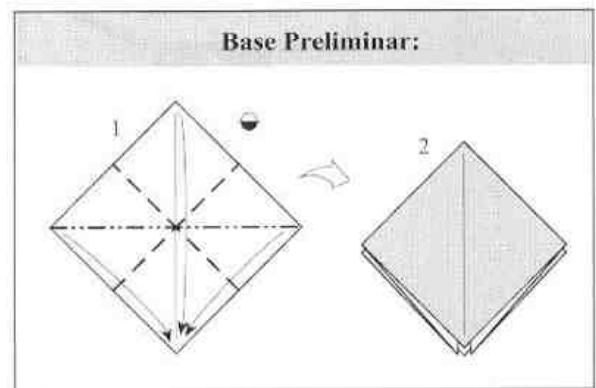
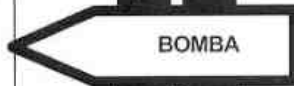
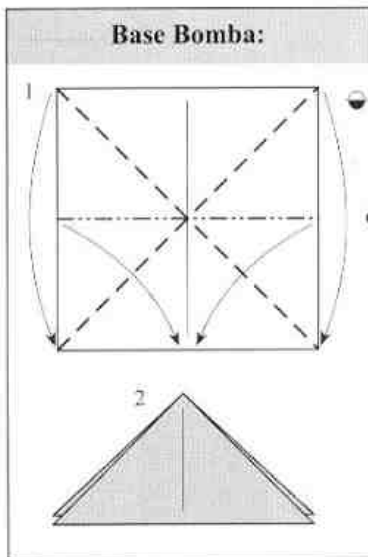
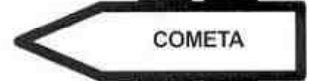
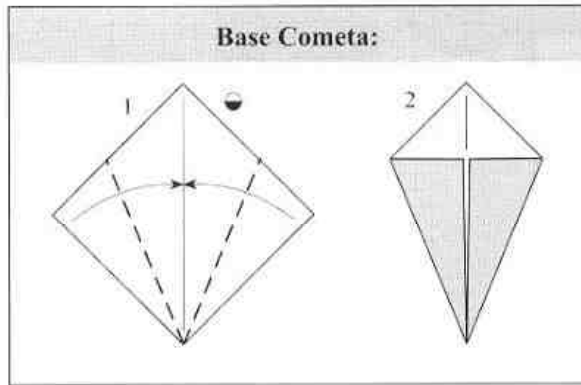

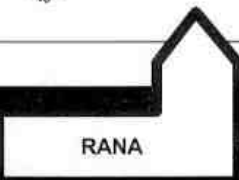
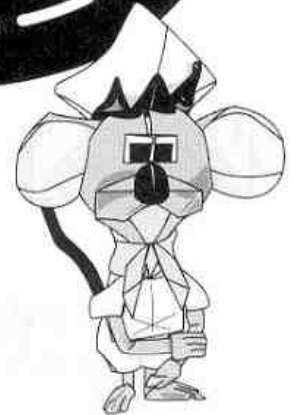
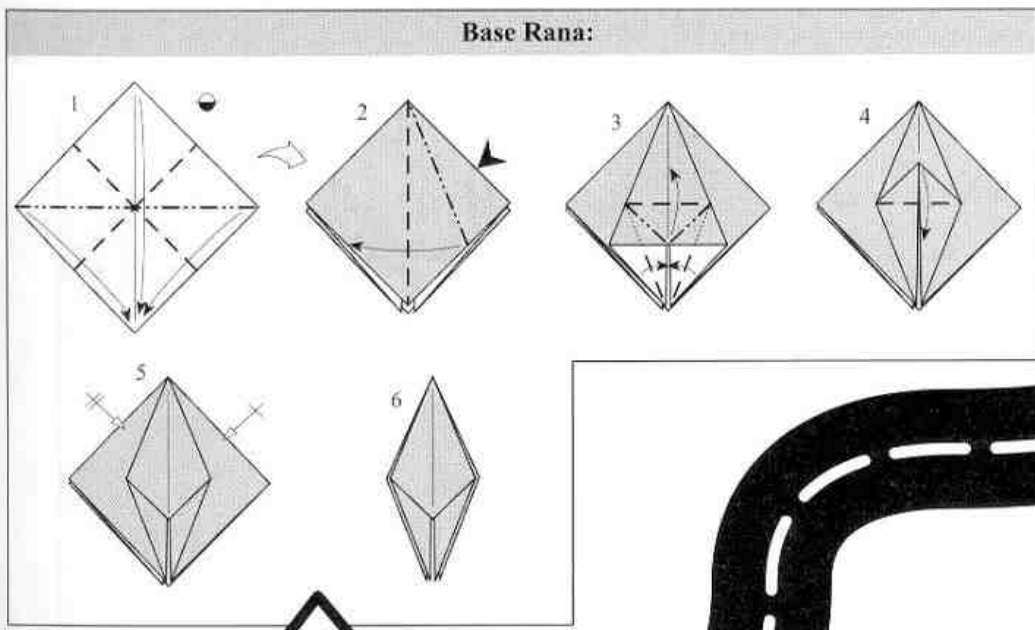
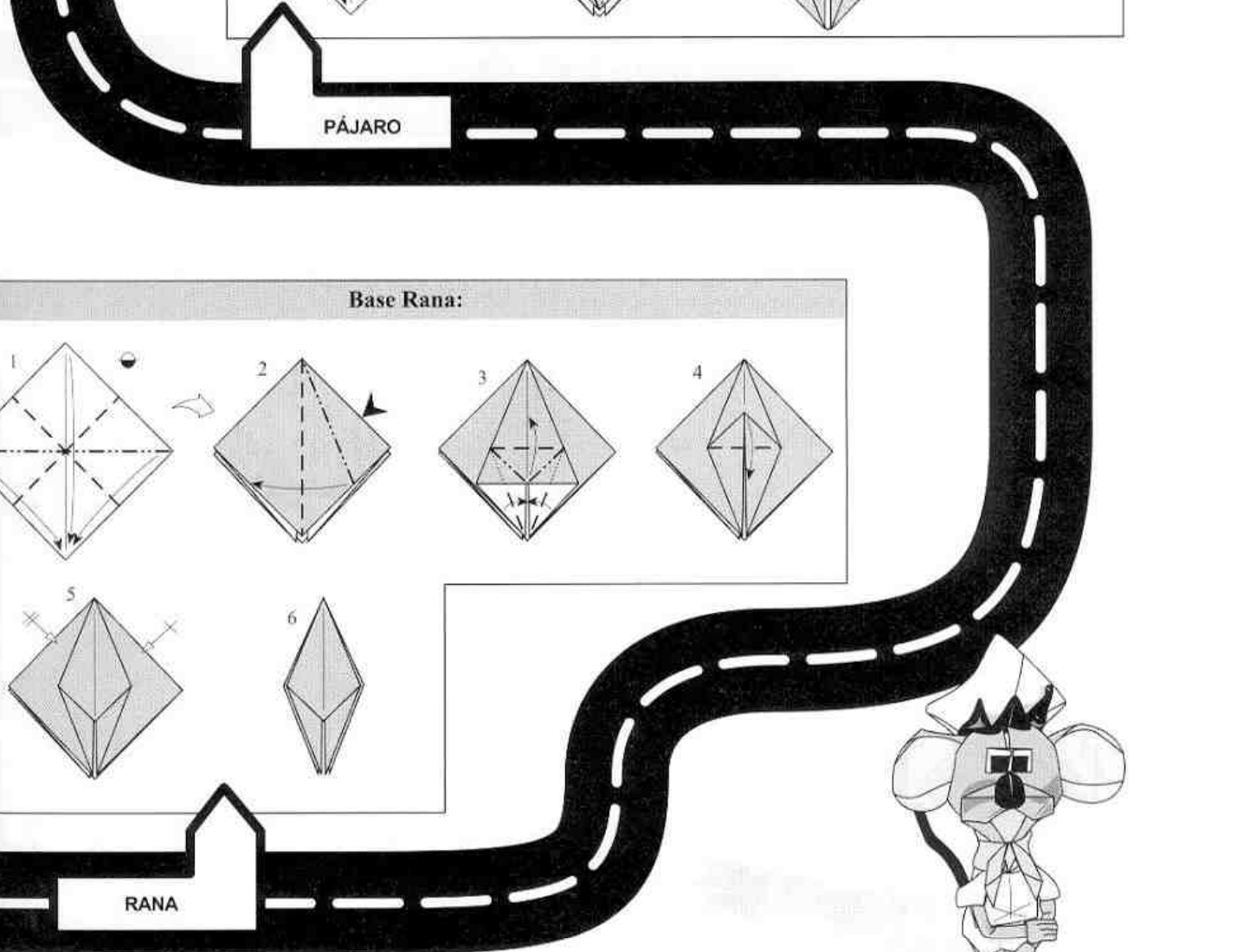
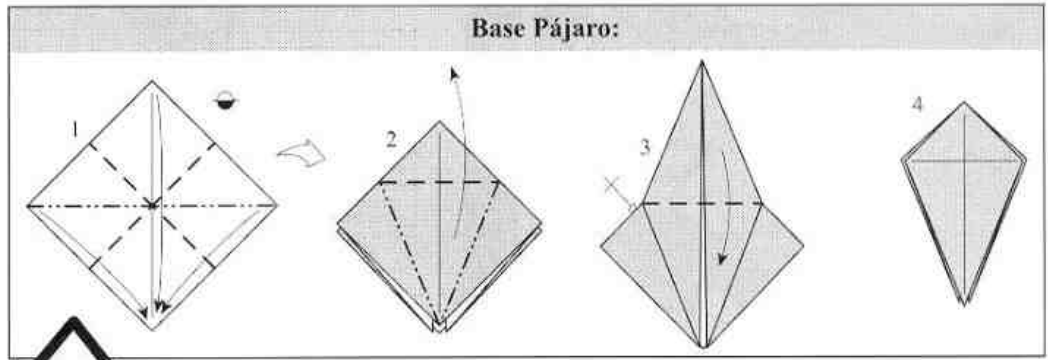
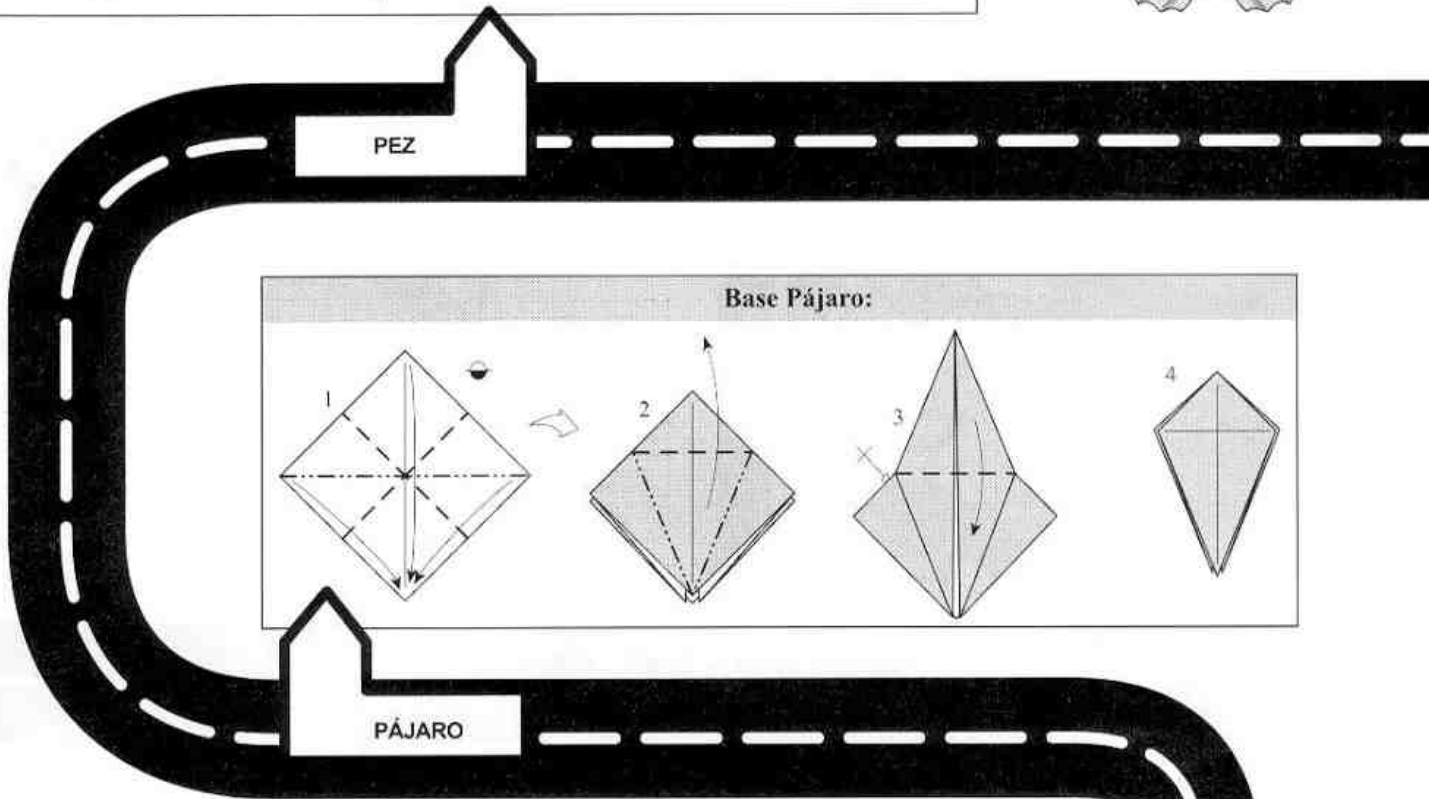
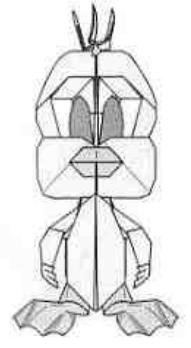
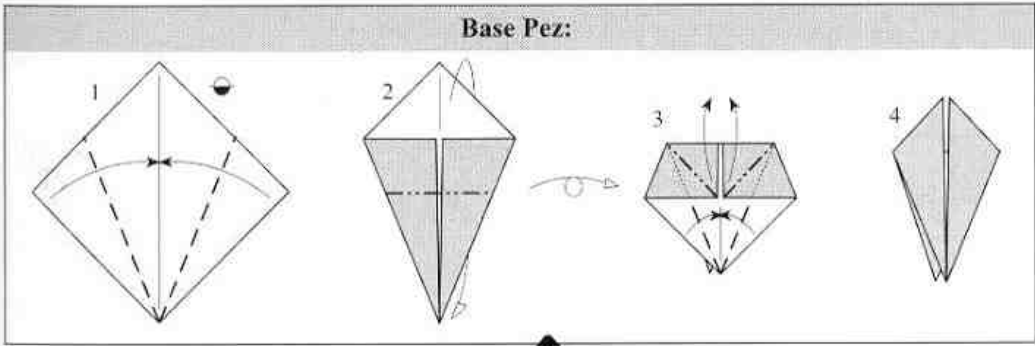

Base Pájaro estirada:

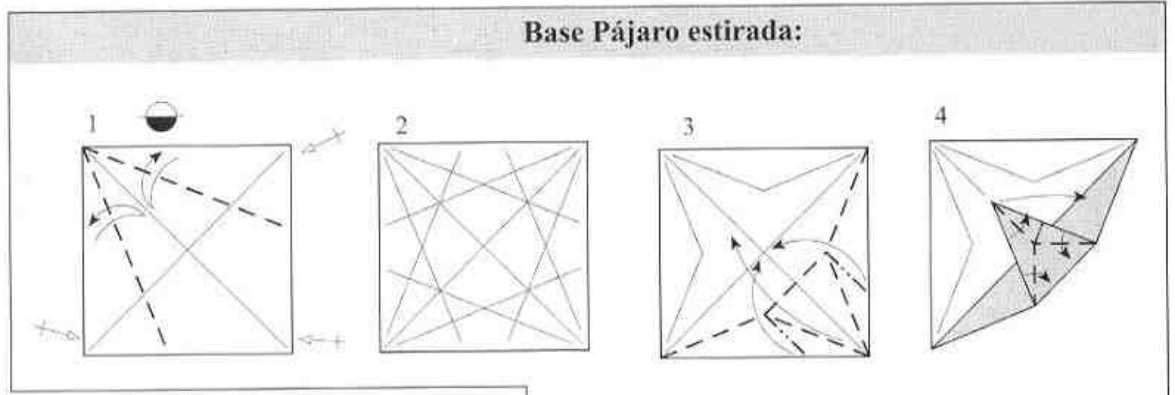

PÁJARO ESTIRADA



5 Repetir 3 y 4.

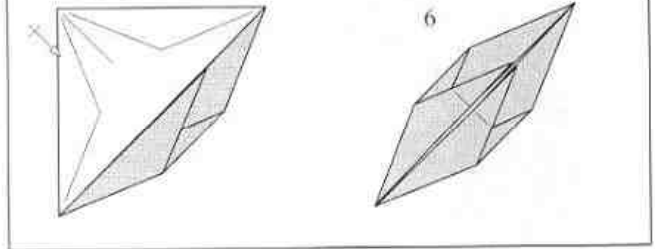

BLINTZ PEZ

Base Blintz Pez:

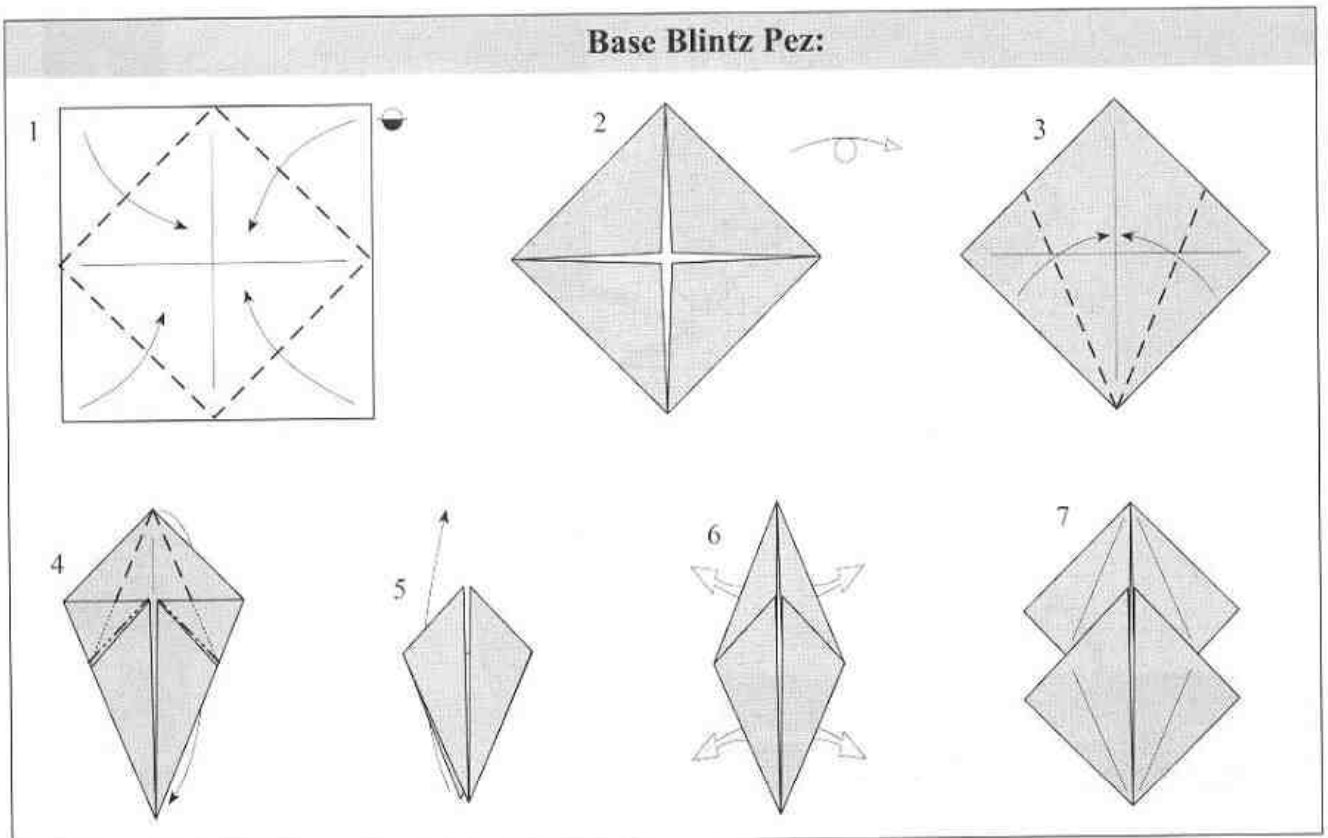

Base Blintz Pájaro:

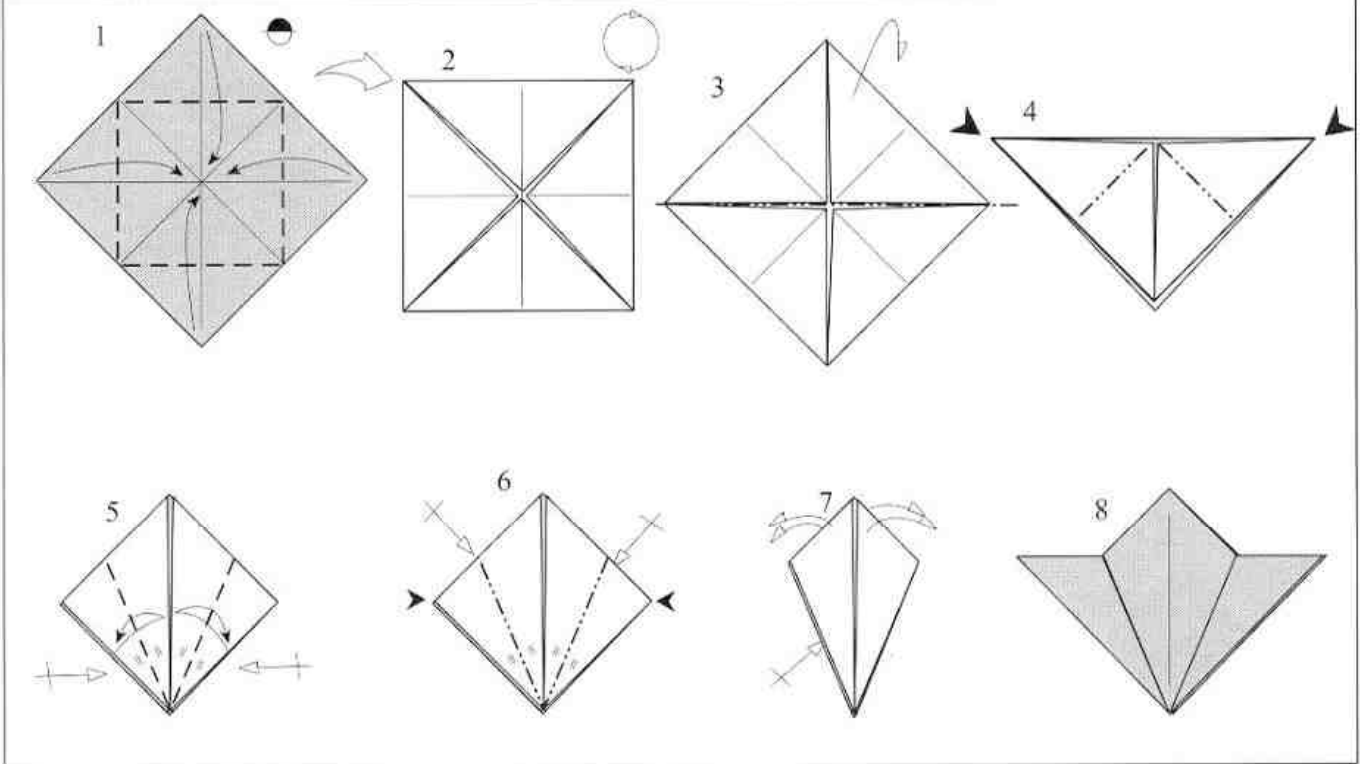

BLINTZ PÁJARO

BLINTZ RANA

Base Blintz Rana:

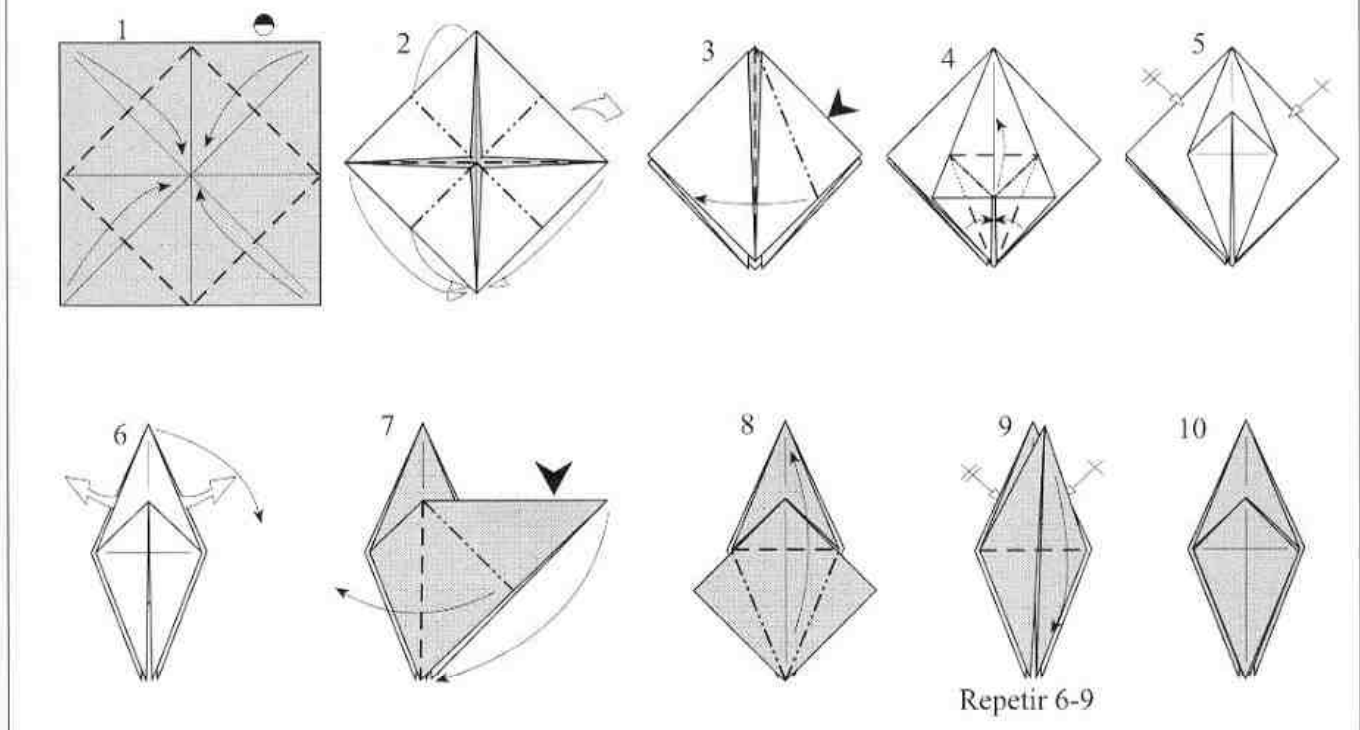

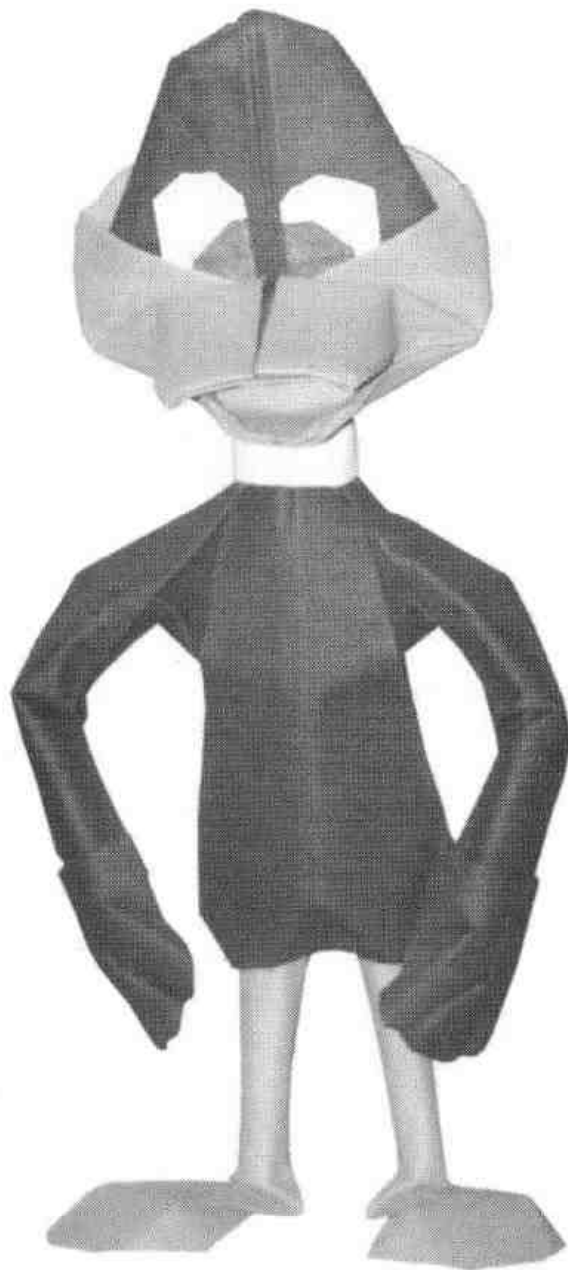

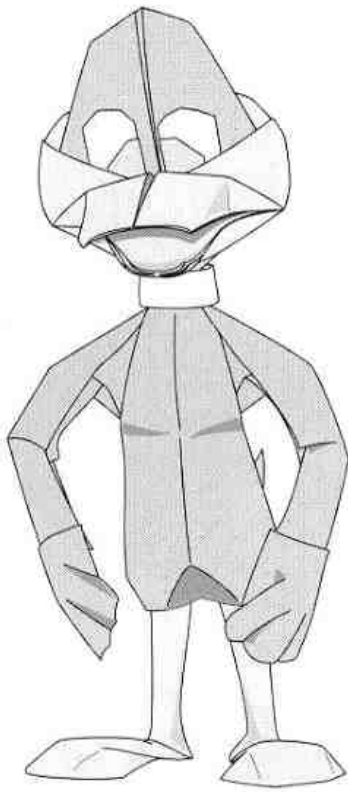

Utilizando las medidas recomendadas, se obtiene un modelo final de 14 cms.

Autor:	Halle
Nivel de dificultad:	Medio-Alto
Número de piezas:	8
Forma de las piezas:	Cuadrados

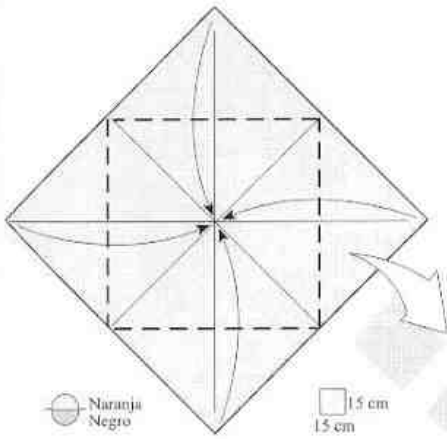

15 cm
15 cm

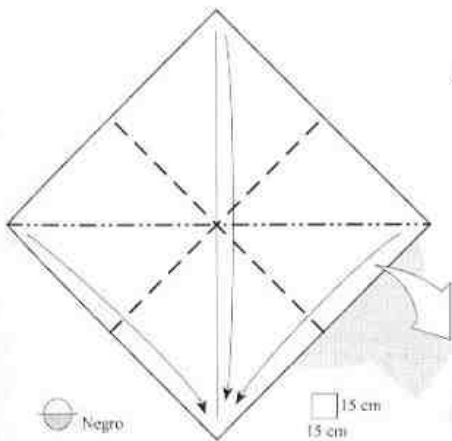
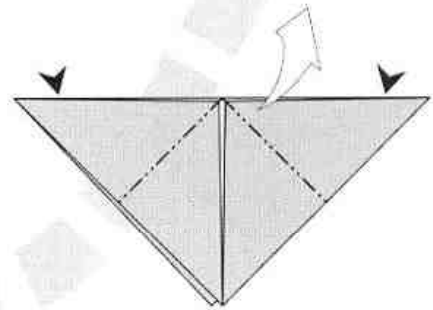
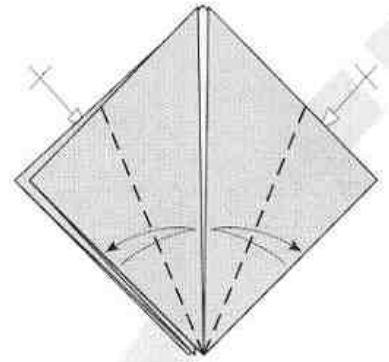
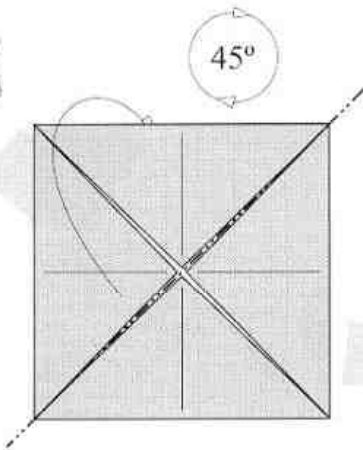

15 cm
15 cm

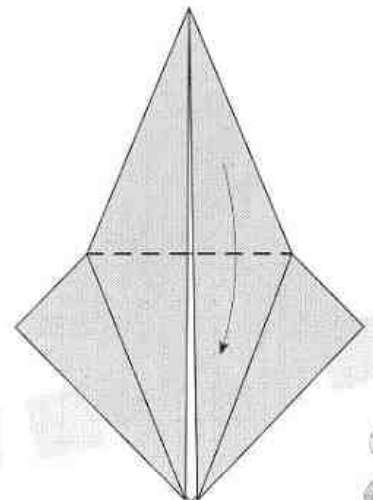
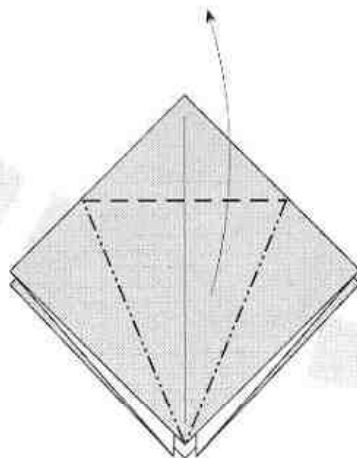

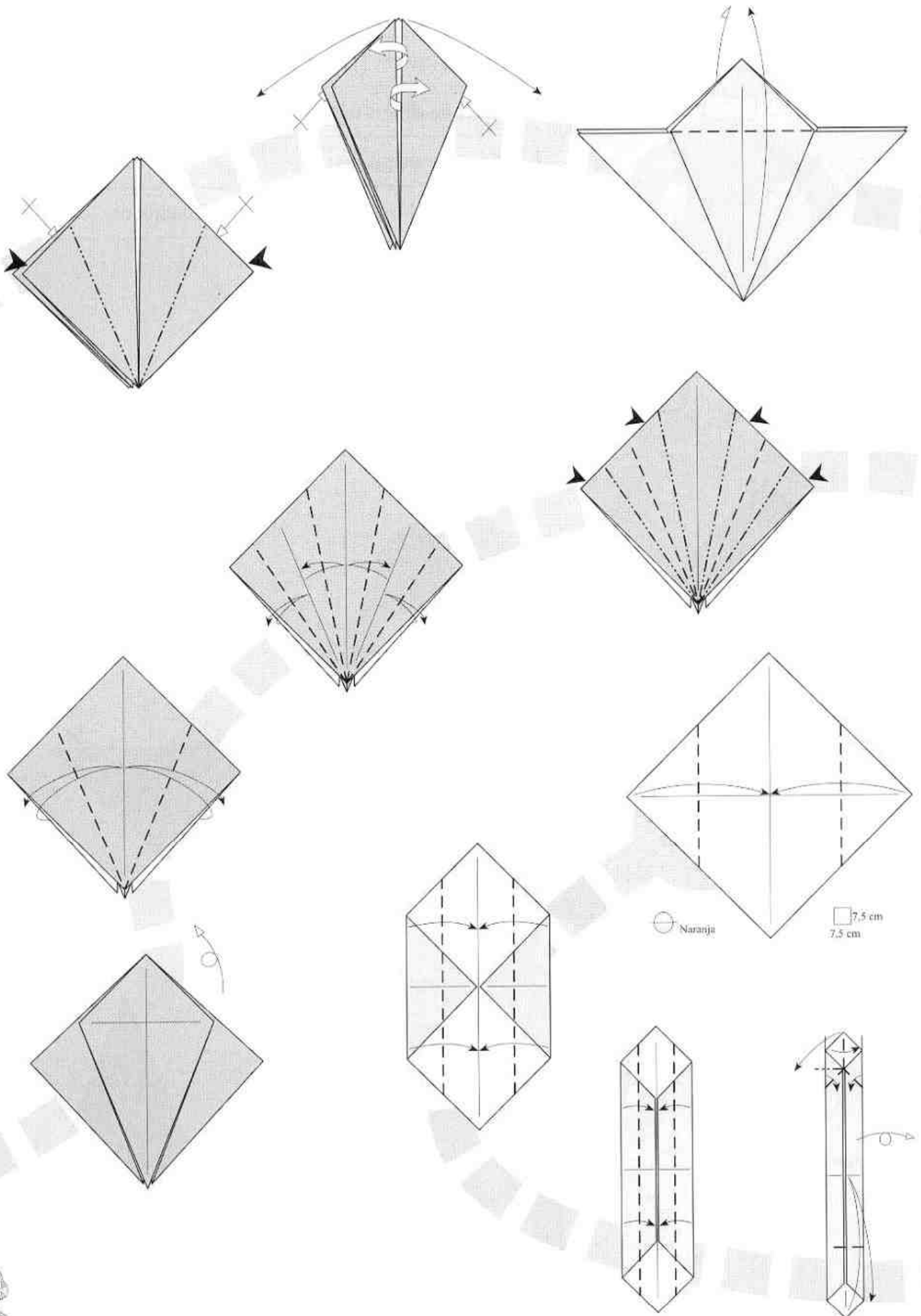

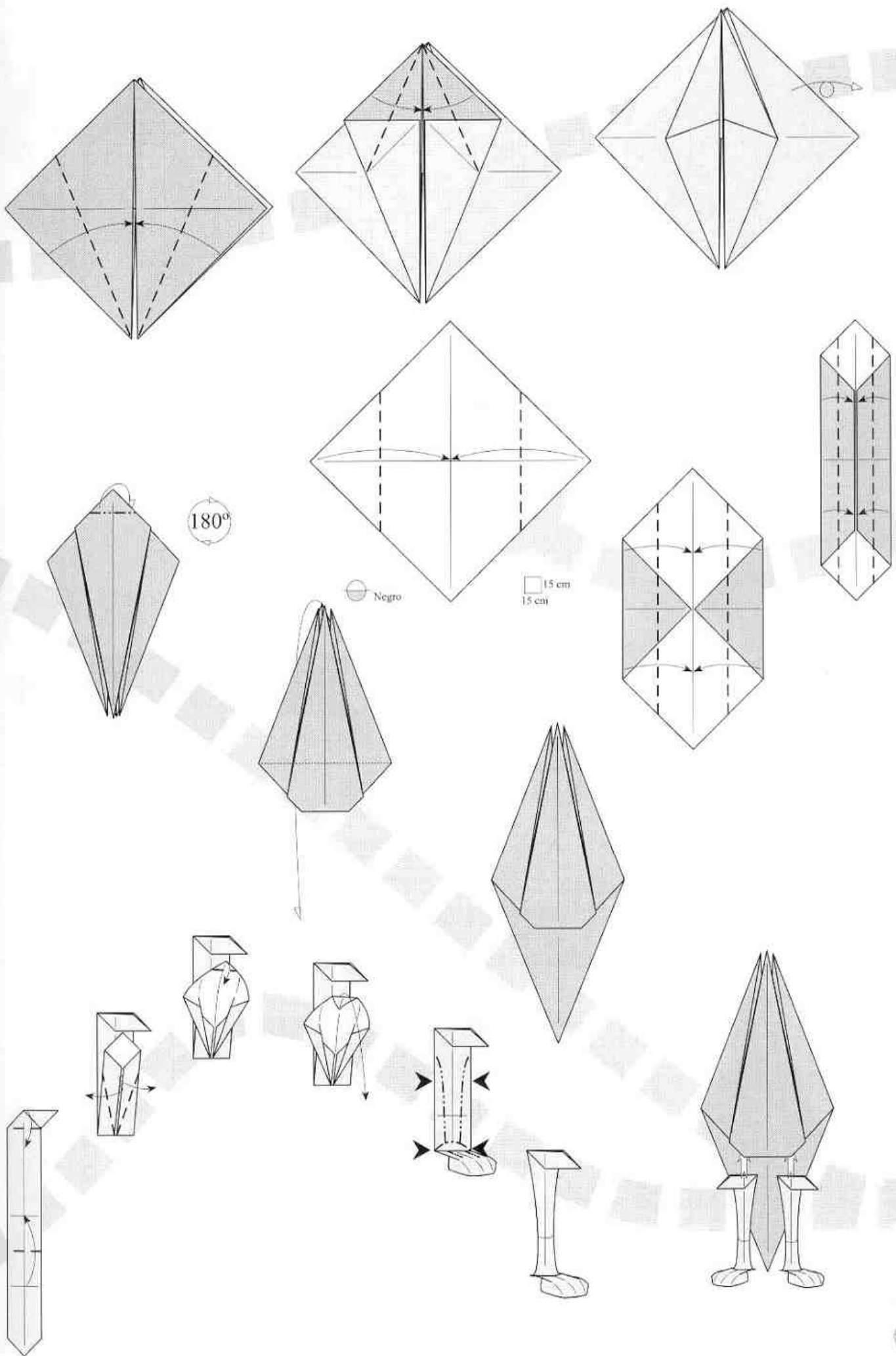

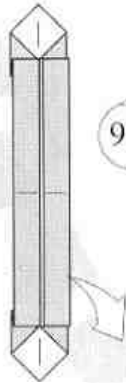
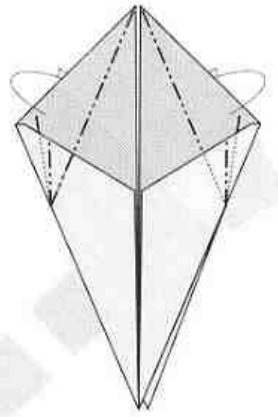
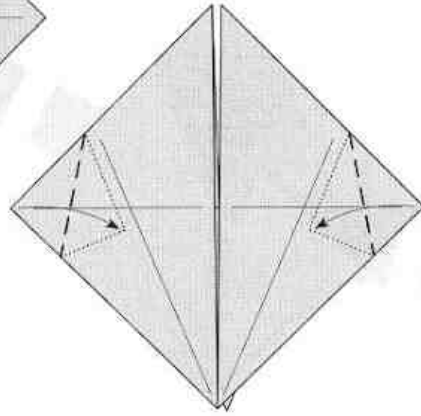
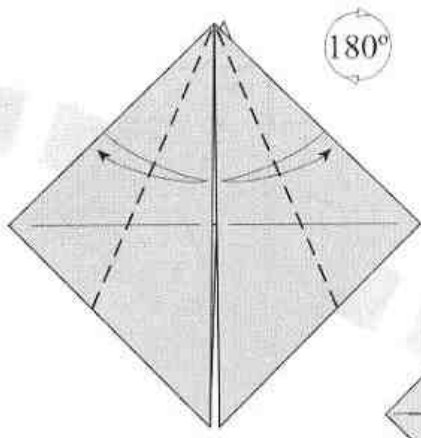

90°

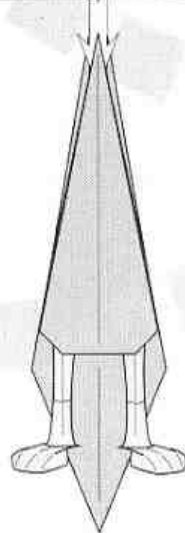
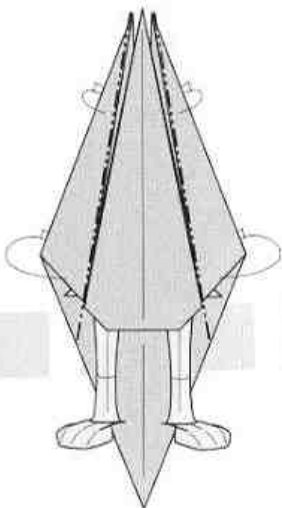
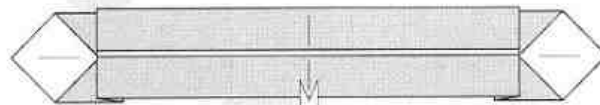
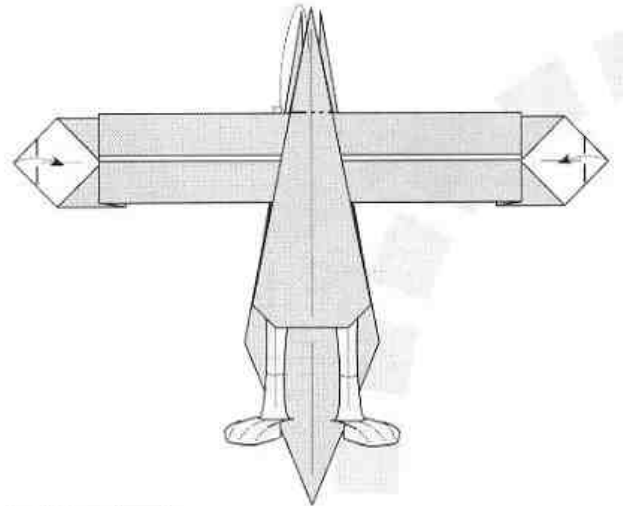
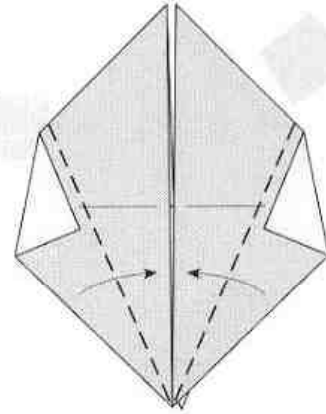

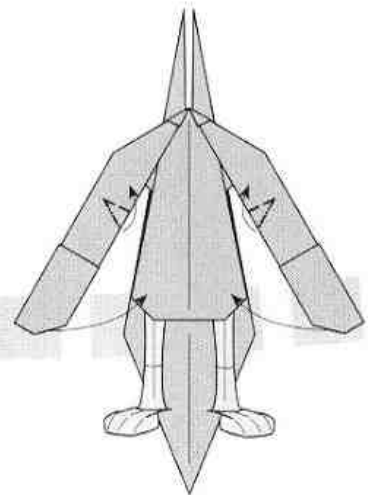
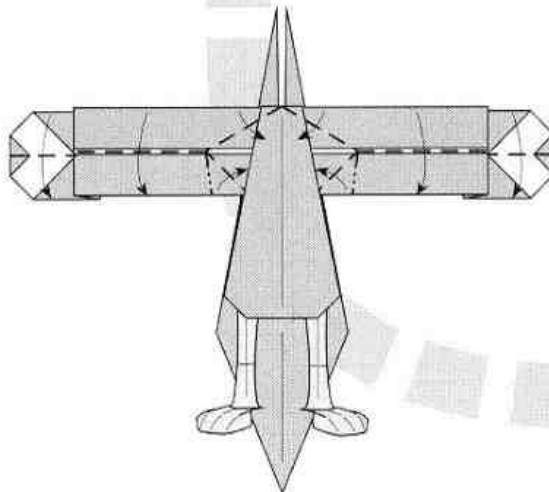
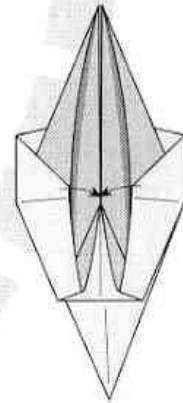
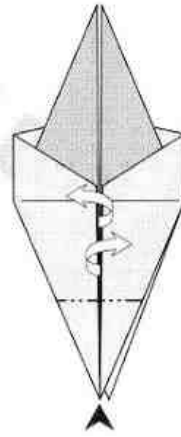
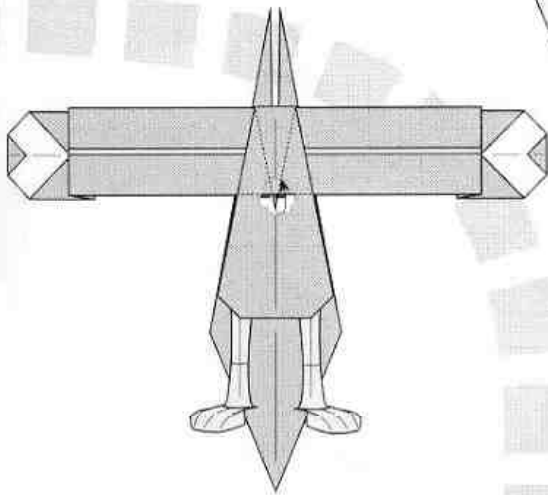
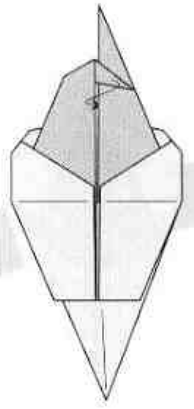
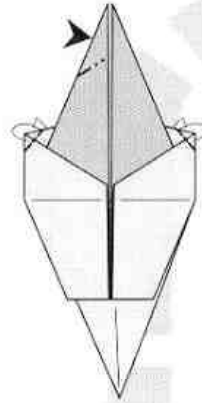
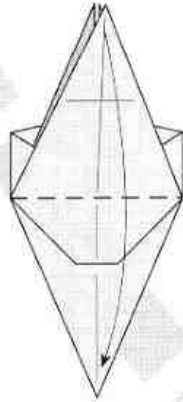
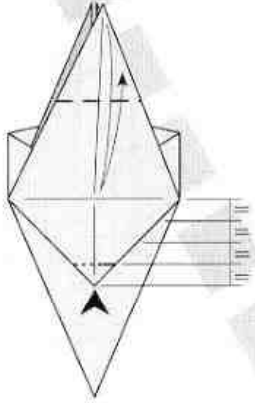
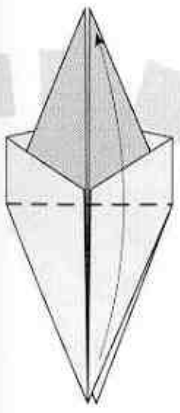

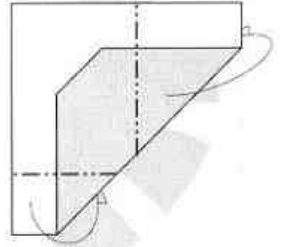
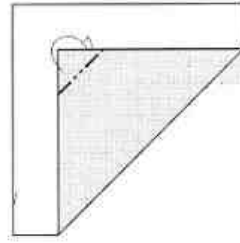
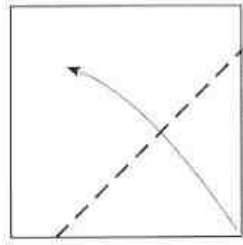
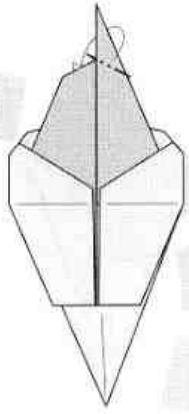

○ Blanco
○ Azul

□ 2 cm
□ 2 cm

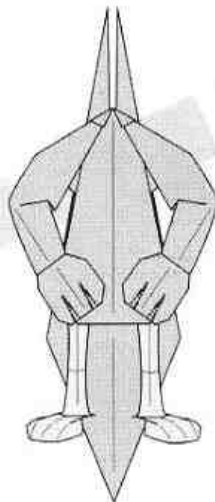
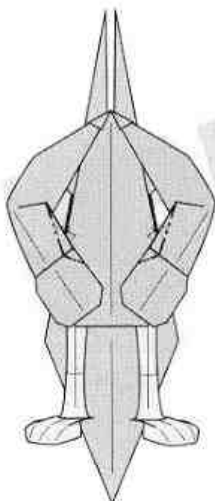
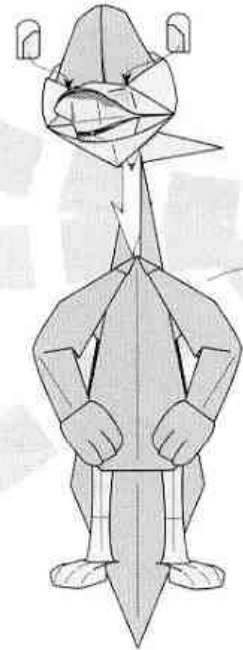
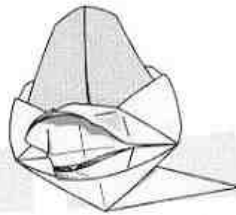
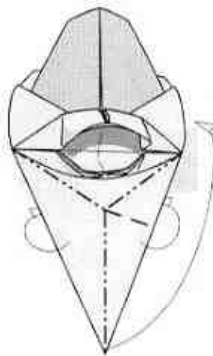
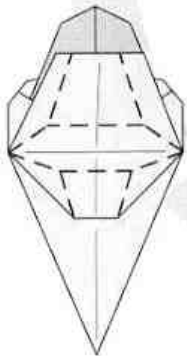
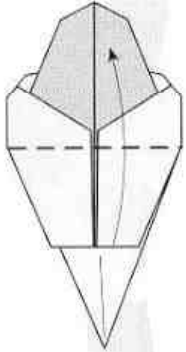
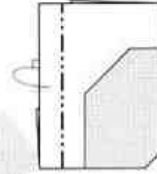

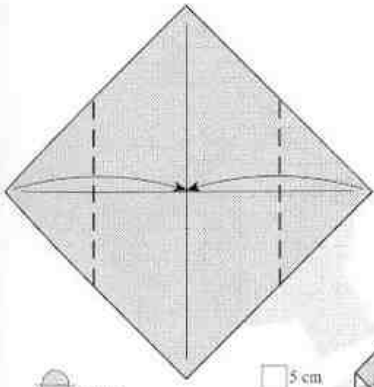

Blanco

5 cm
5 cm

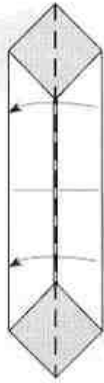
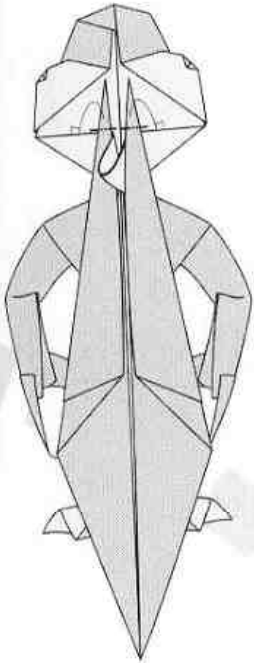
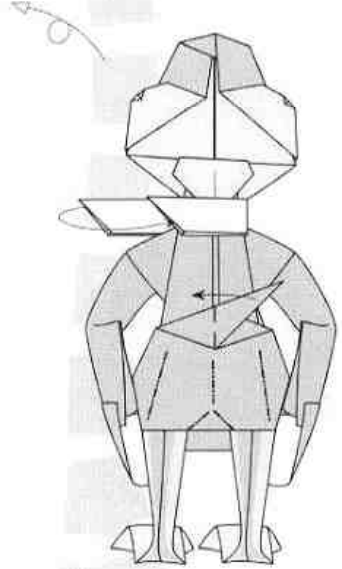
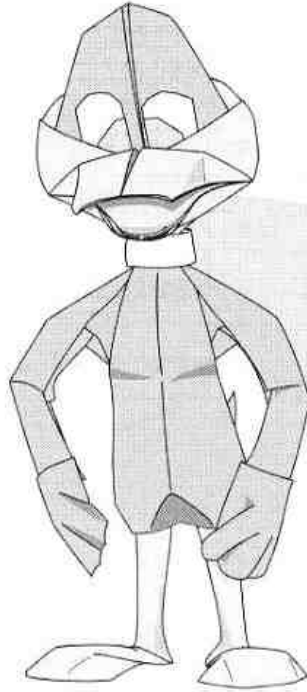
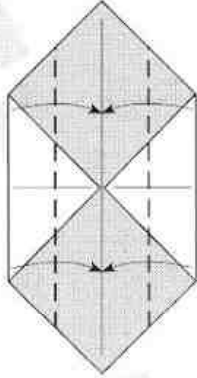

90°

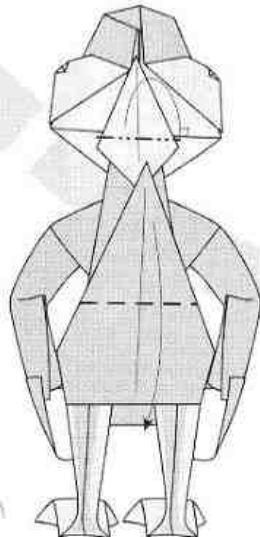
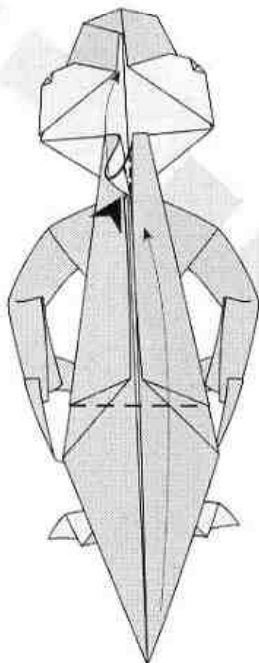
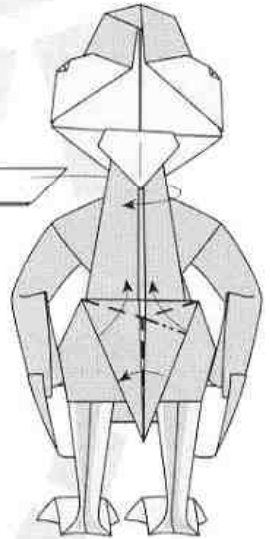



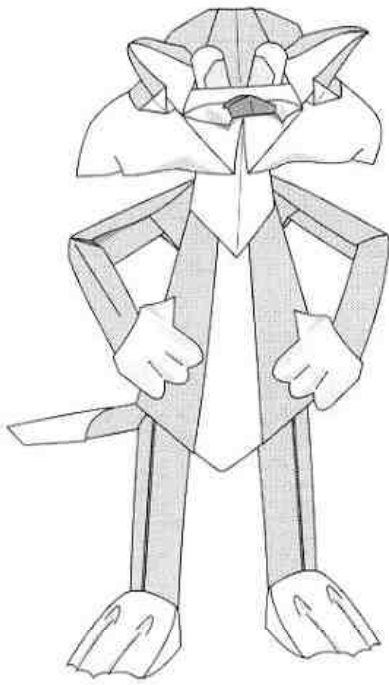

Utilizando las medidas recomendadas, se obtiene un modelo final de 15 cms.

Autor:	Halle
Nivel de dificultad:	Medio-Alto
Número de piezas:	10
Forma de las piezas:	Cuadrados

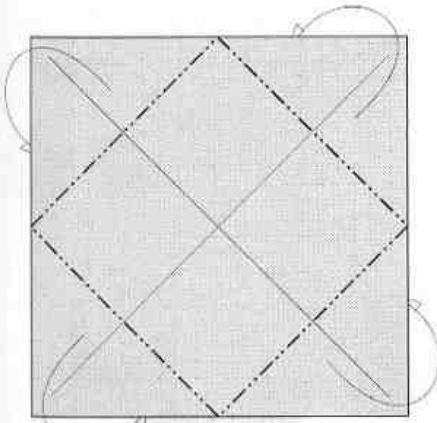

● Negro
○ Blanco

■ 20 cm
□ 20 cm

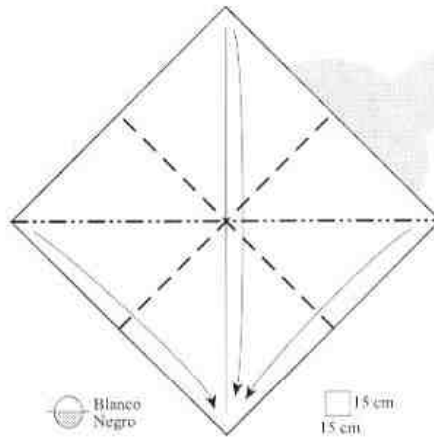
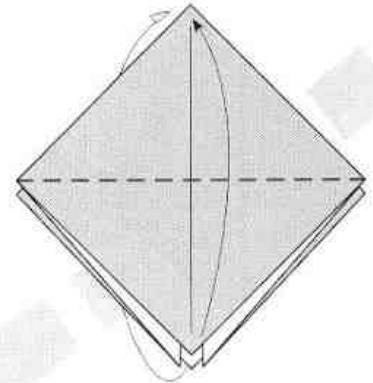

● Blanco
○ Negro

■ 15 cm
□ 15 cm

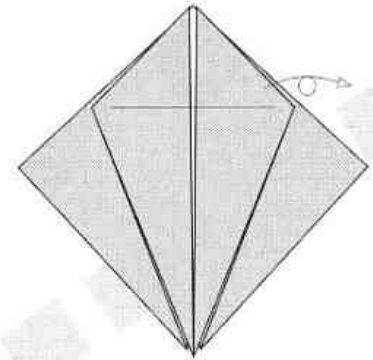
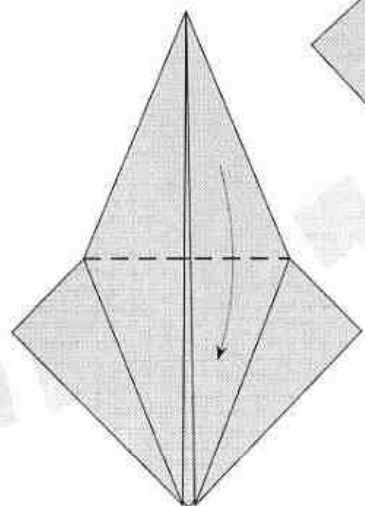
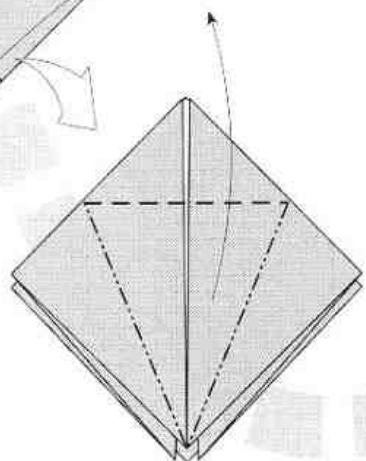
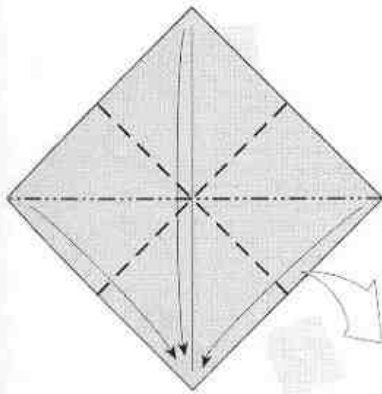

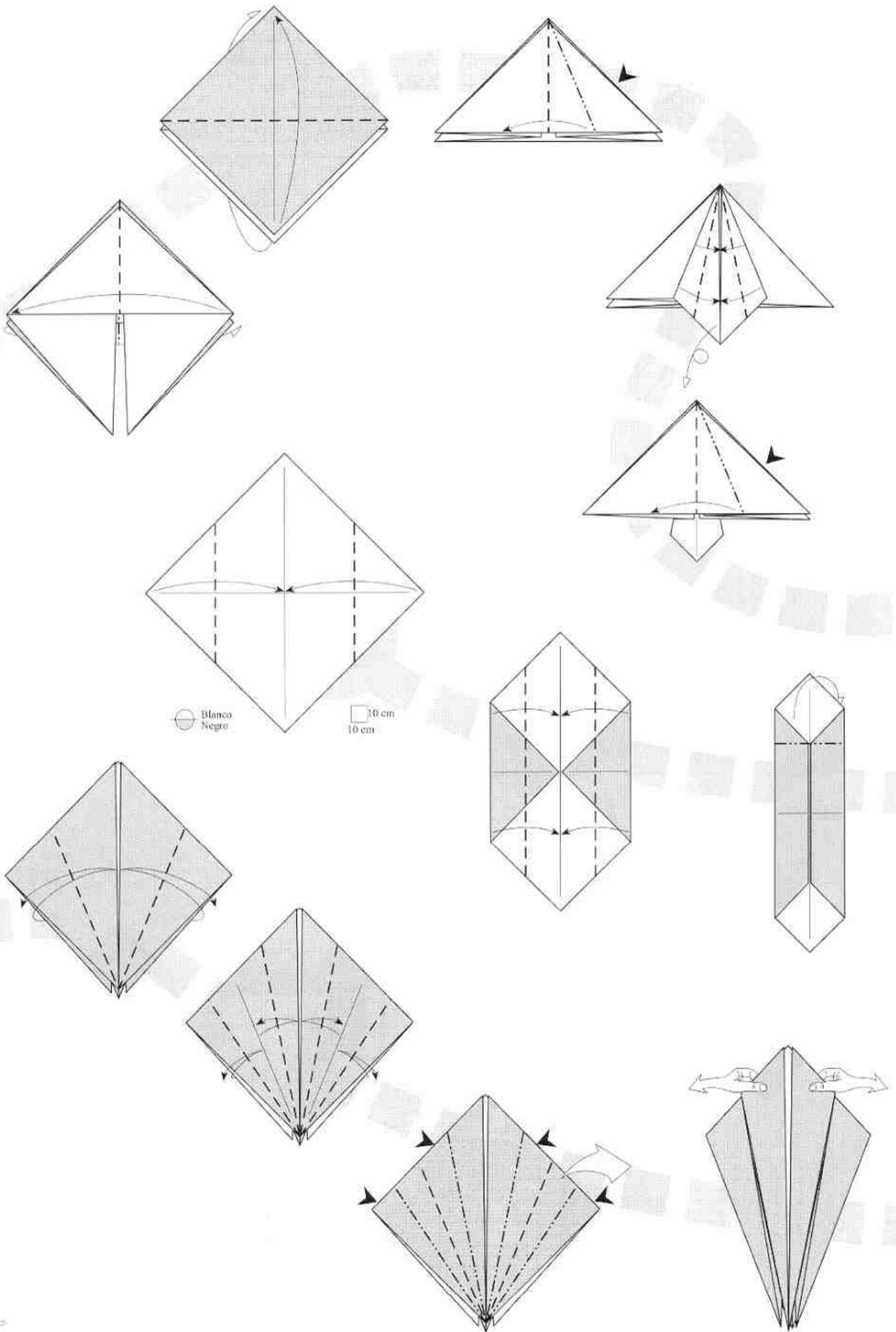

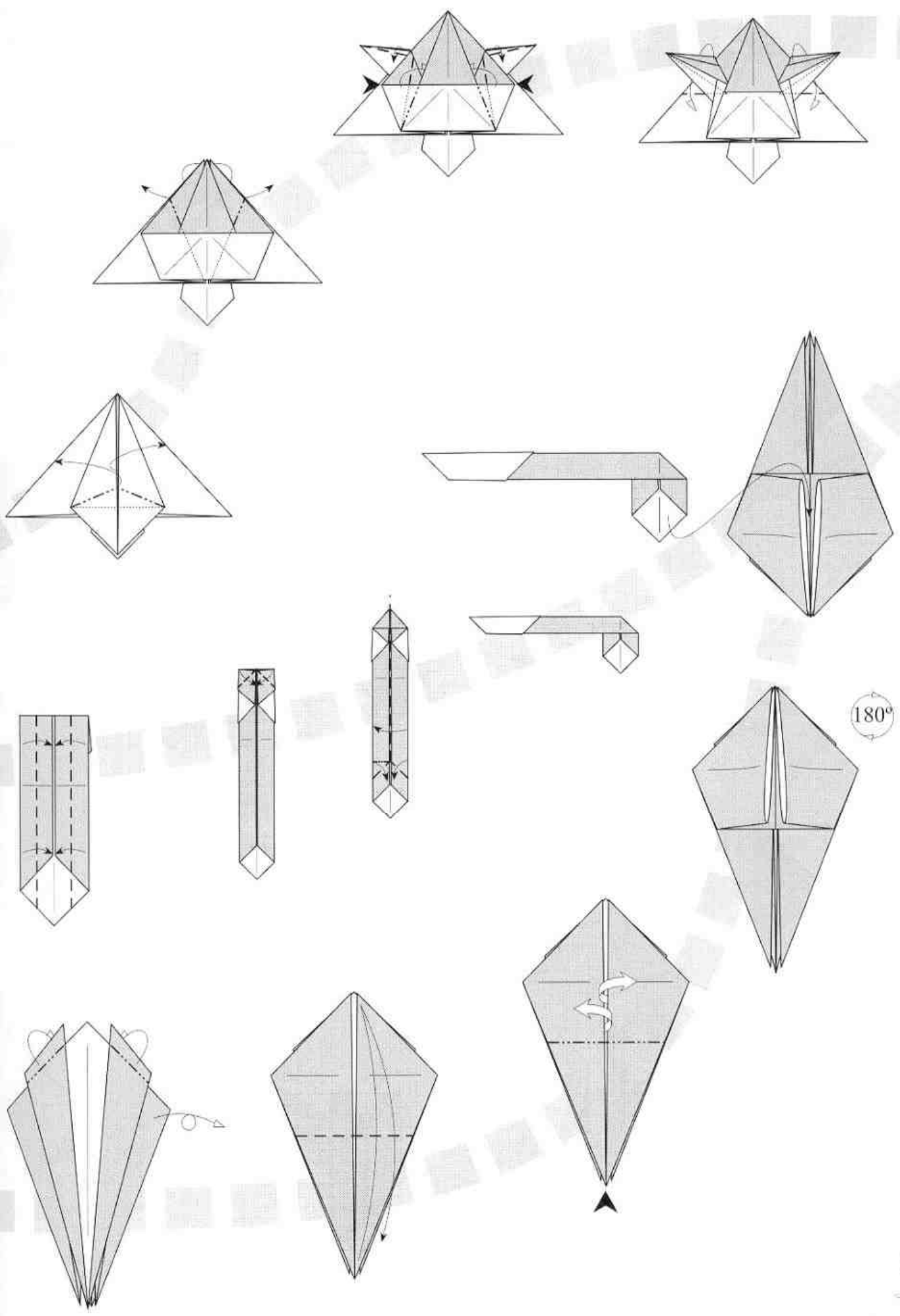

180°



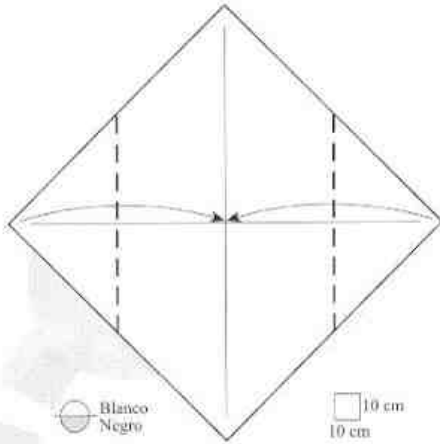
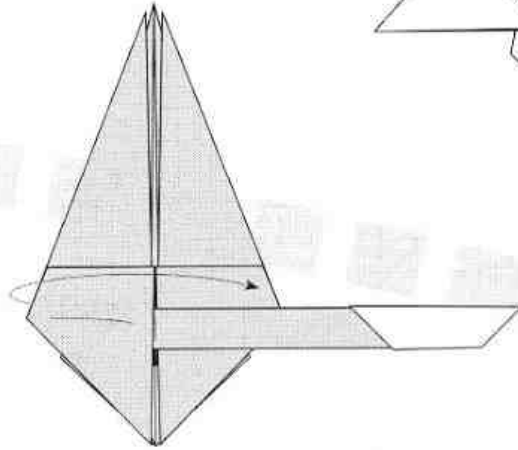
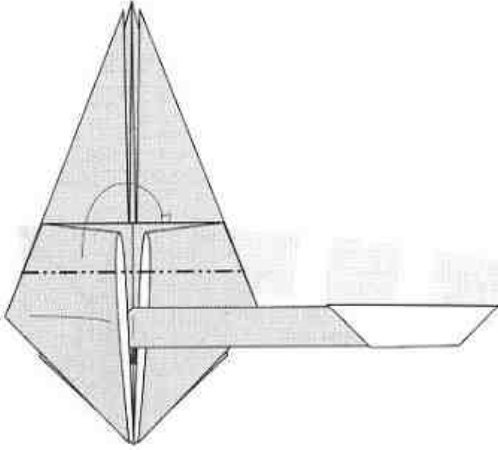
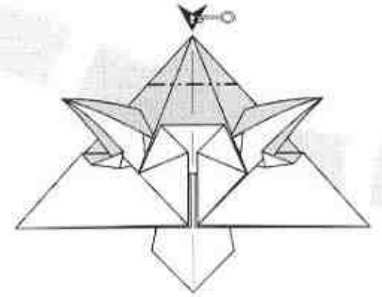
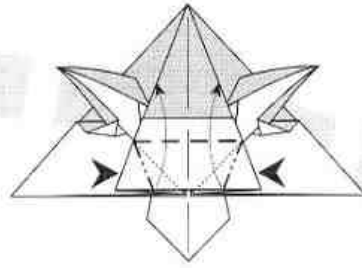
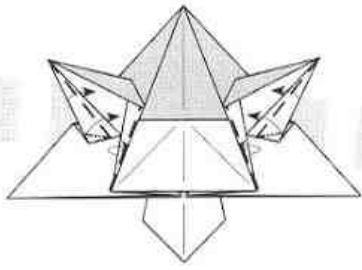

○ Blanco
● Negro

□ 10 cm
□ 10 cm

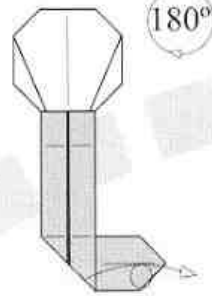
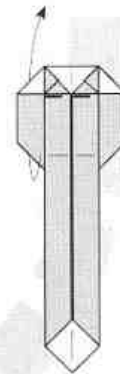
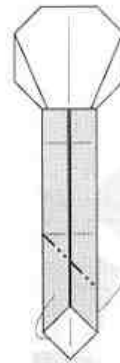
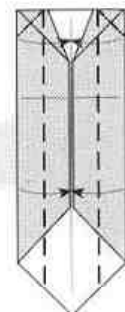
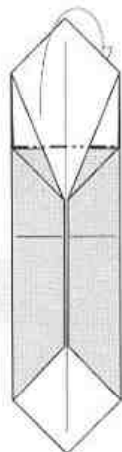
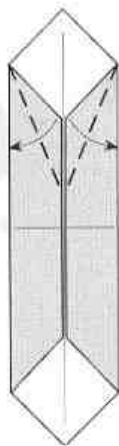
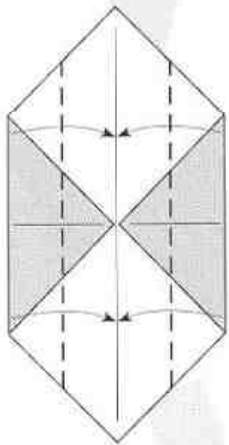

180°



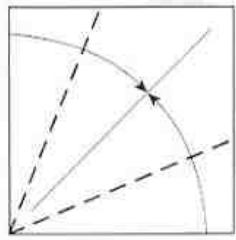

Blanco
Rojo

3,5 cm
3,5 cm

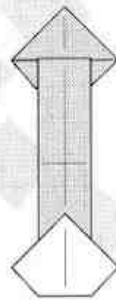
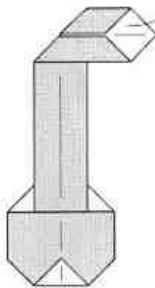
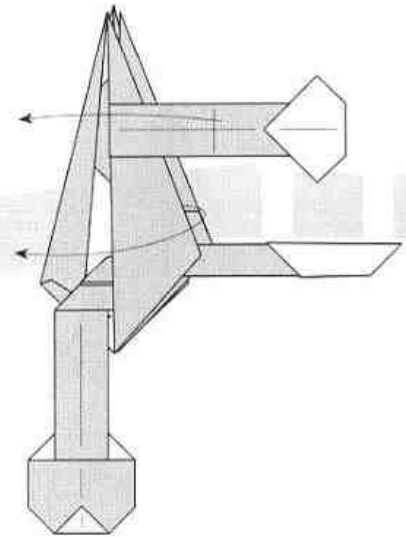
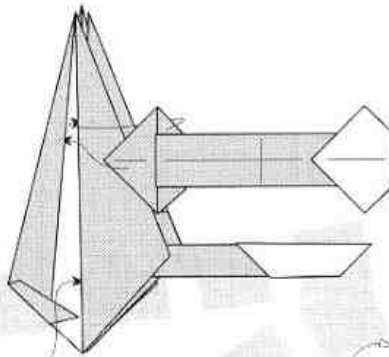
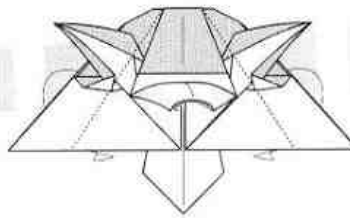
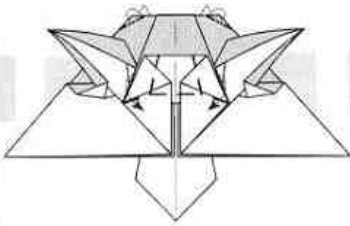
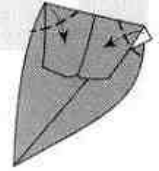
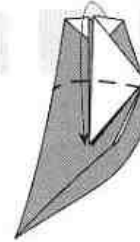
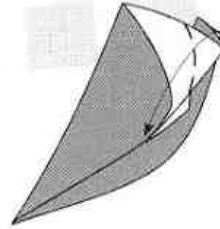
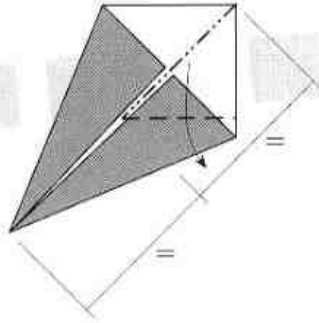

90°

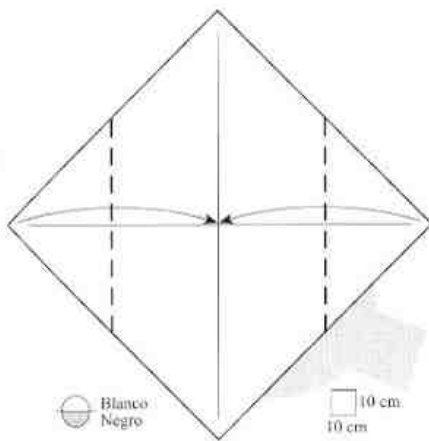
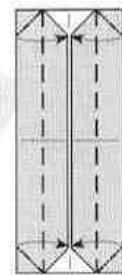
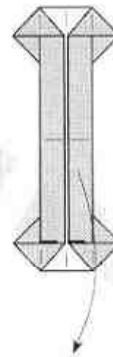

Blanco
Negro

10 cm
10 cm

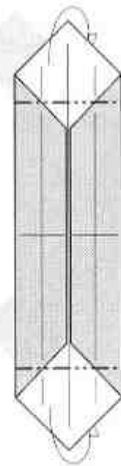
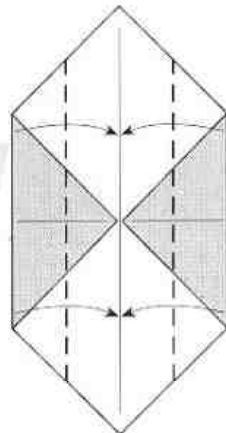

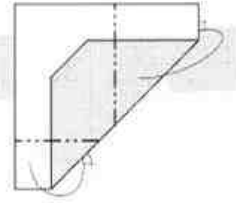
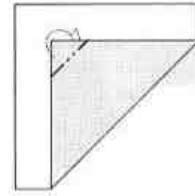
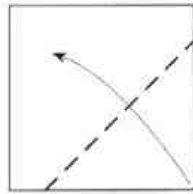
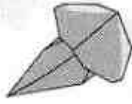
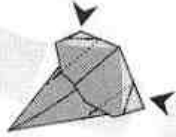
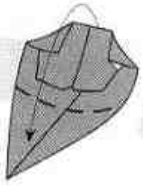

Blanco
Azul

2 cm
2 cm

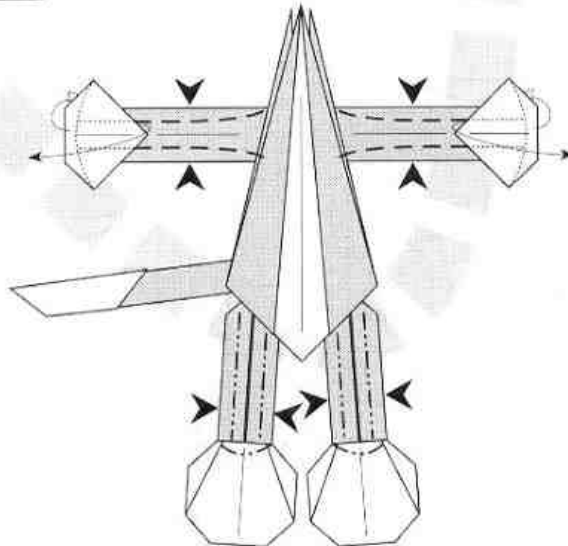
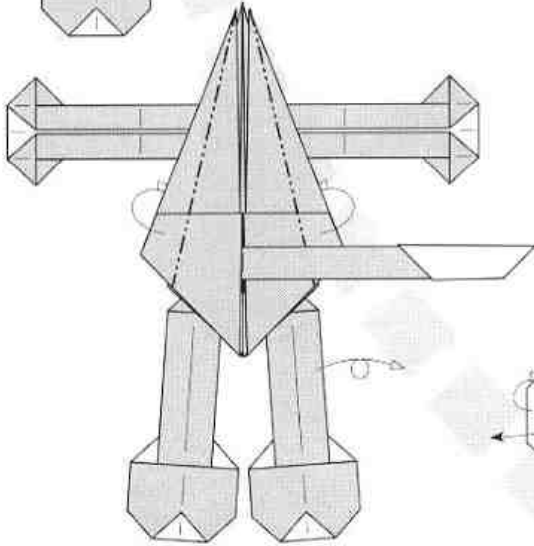
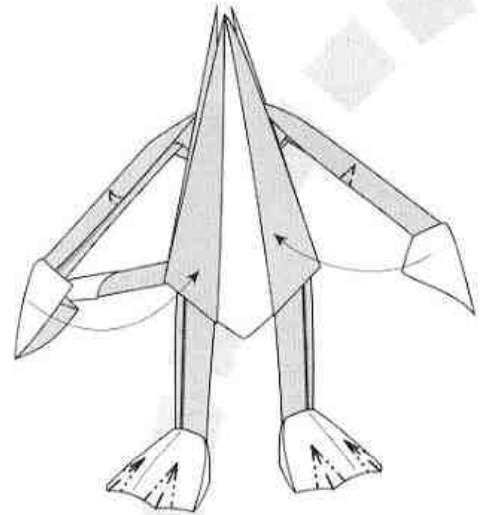
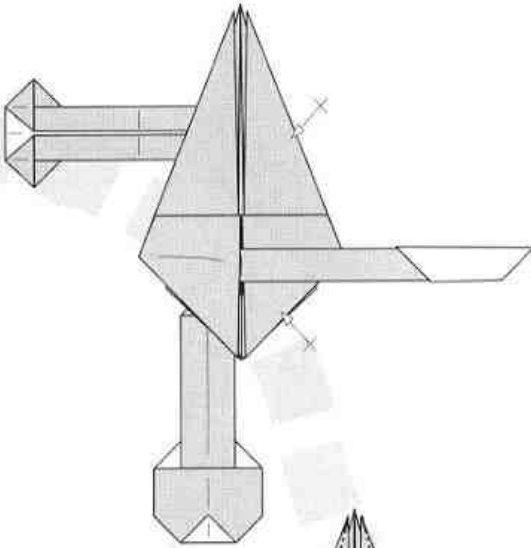
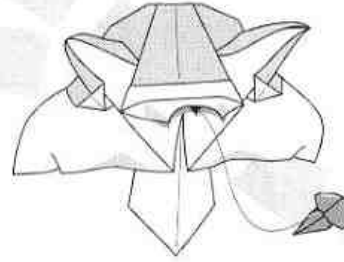
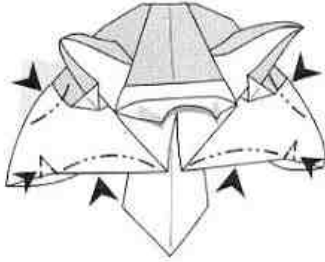

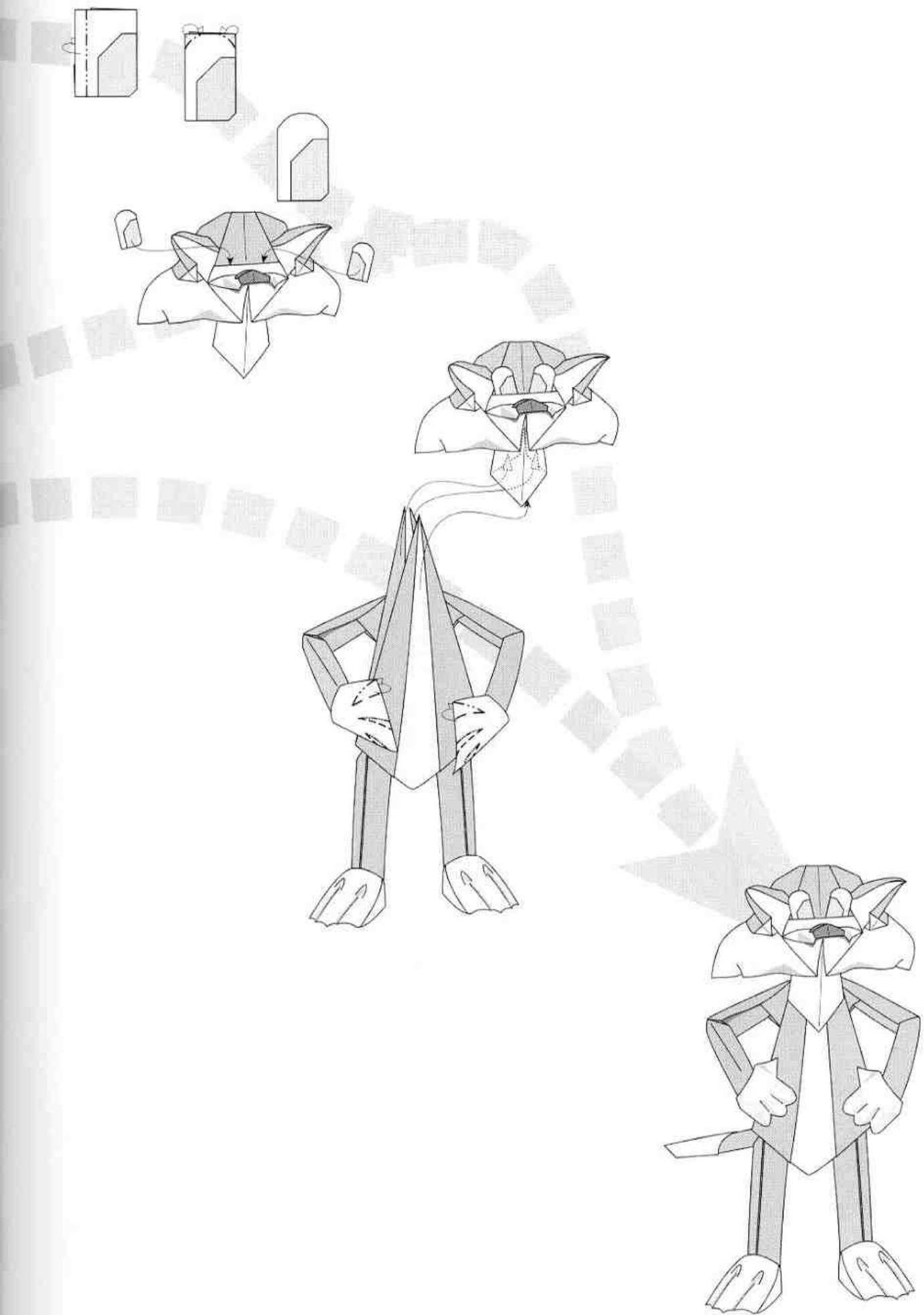

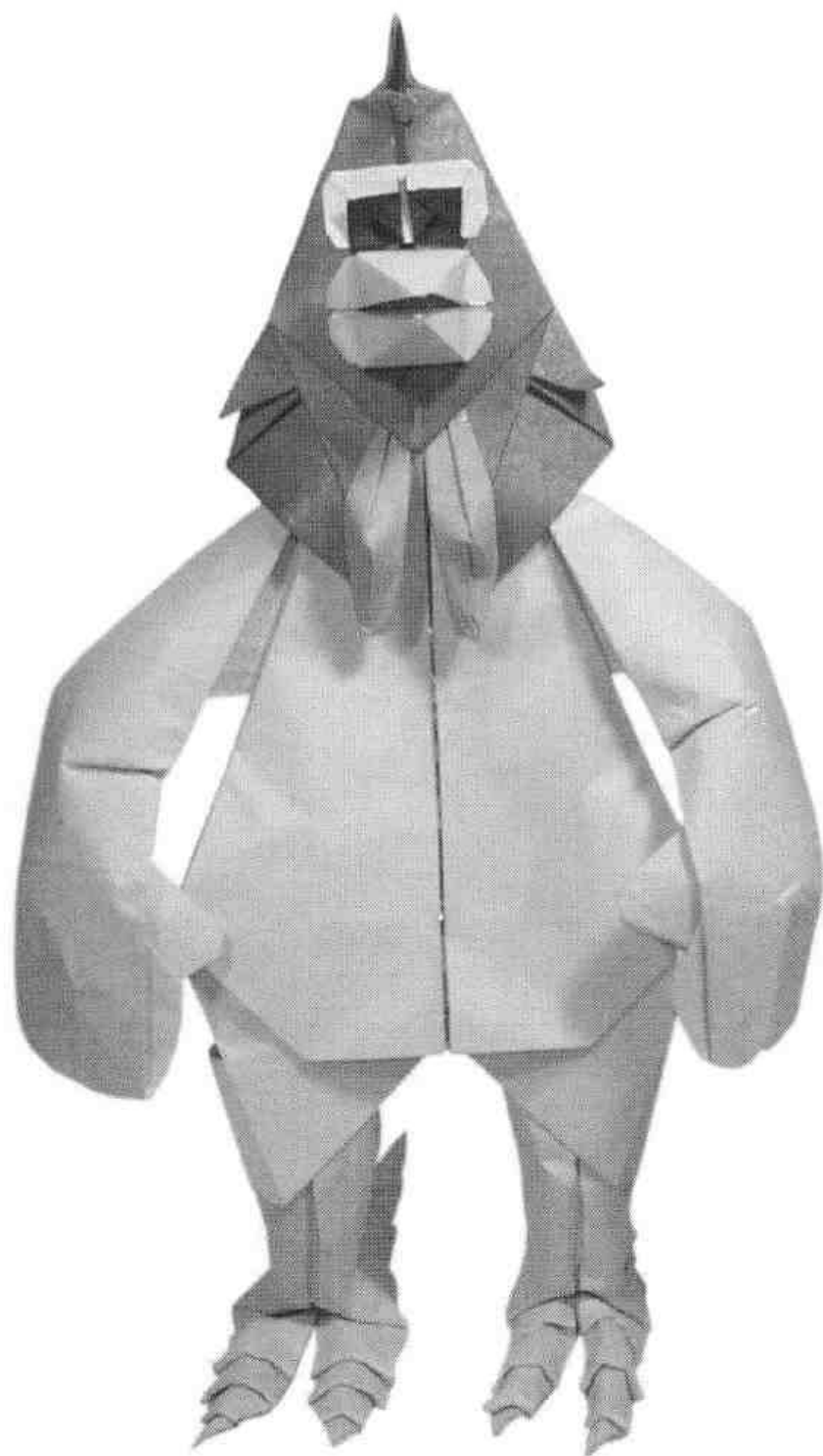

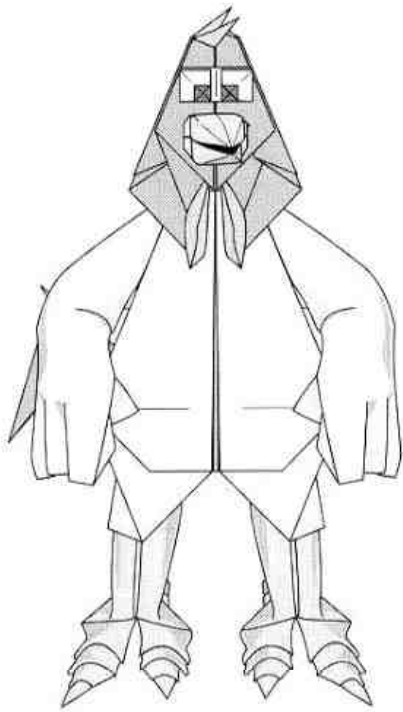

Utilizando las medidas recomendadas, se obtiene un modelo final de 22 cms.

Autor:	Halle
Nivel de dificultad:	Medio-Alto
Número de piezas:	10
Forma de las piezas:	Cuadrados

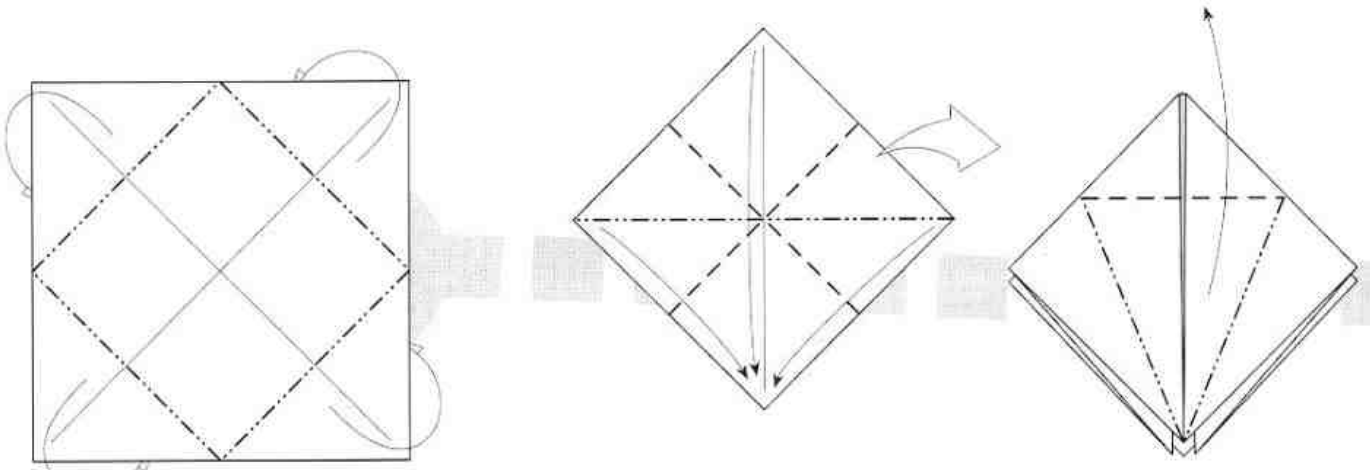

Blanco 30 cm
30 cm

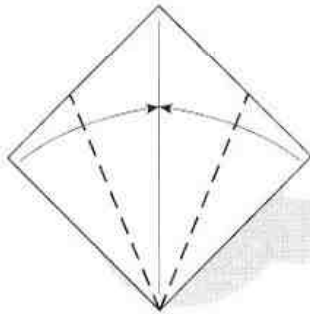

Rojo 5 cm
5 cm

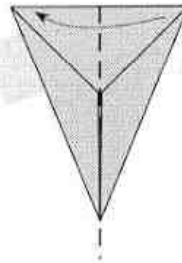
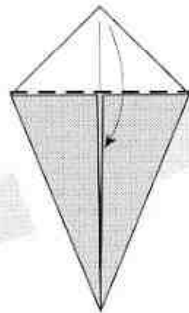

90°

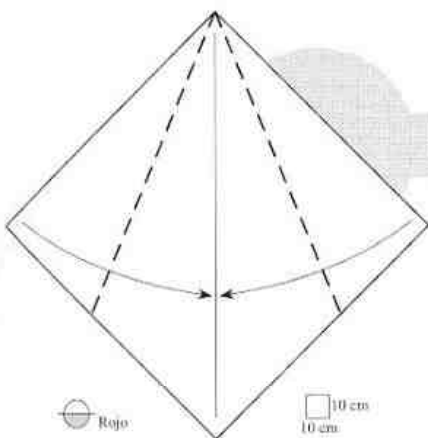

Rojo 10 cm
10 cm

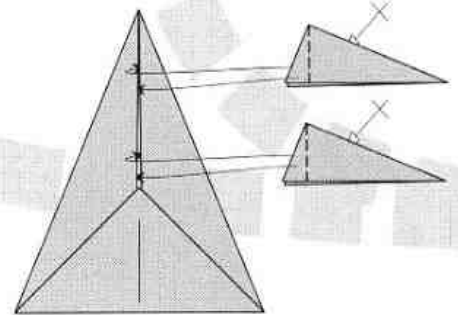
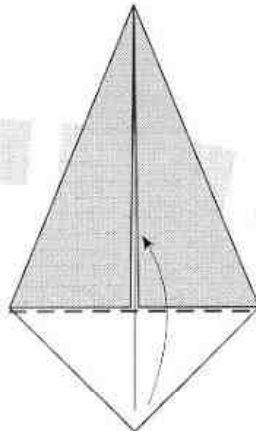

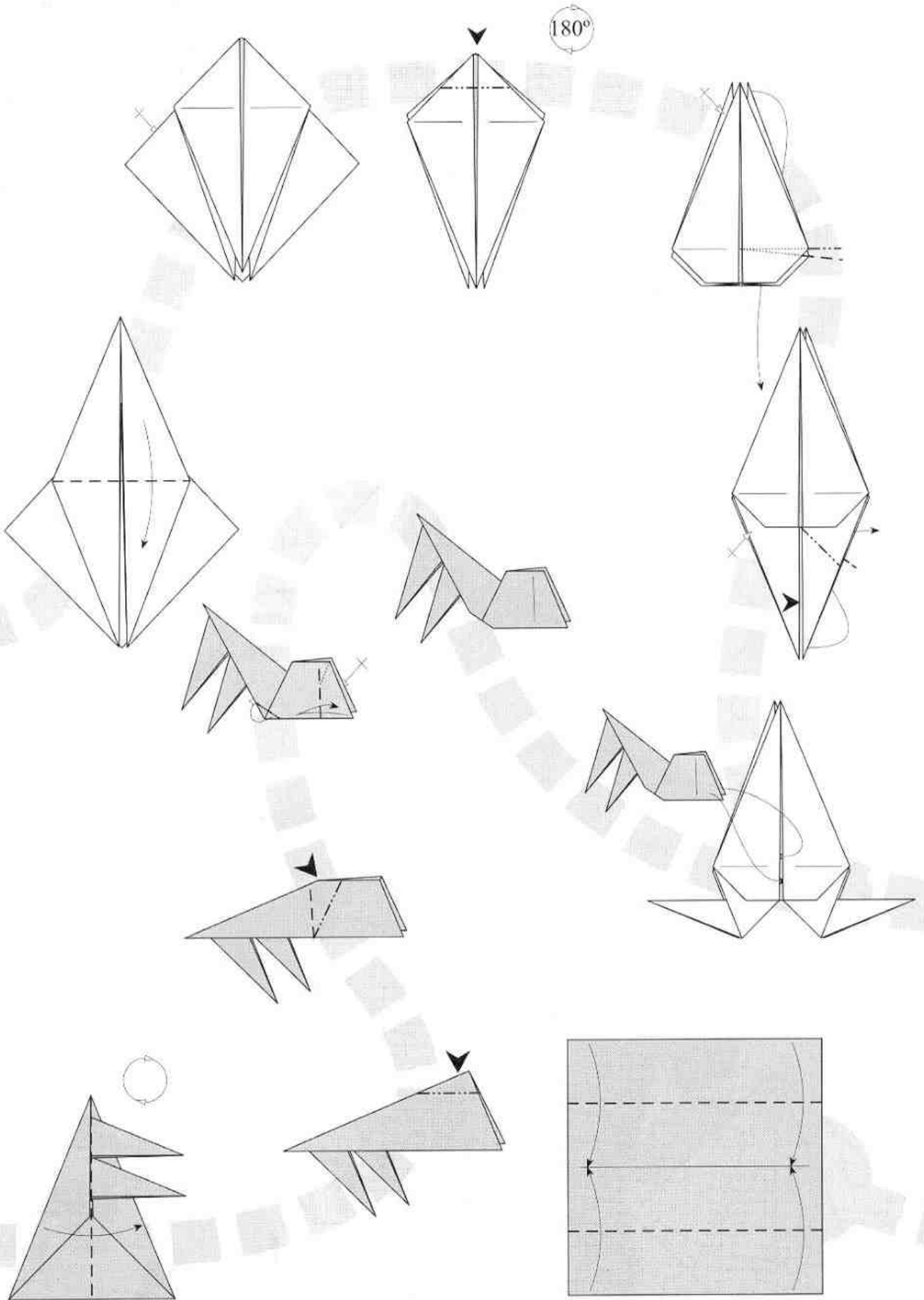

180°

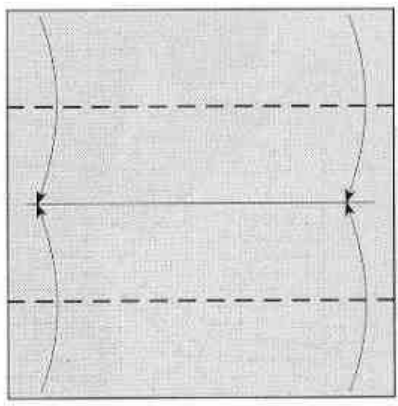

Blanco

80 cm
30 cm



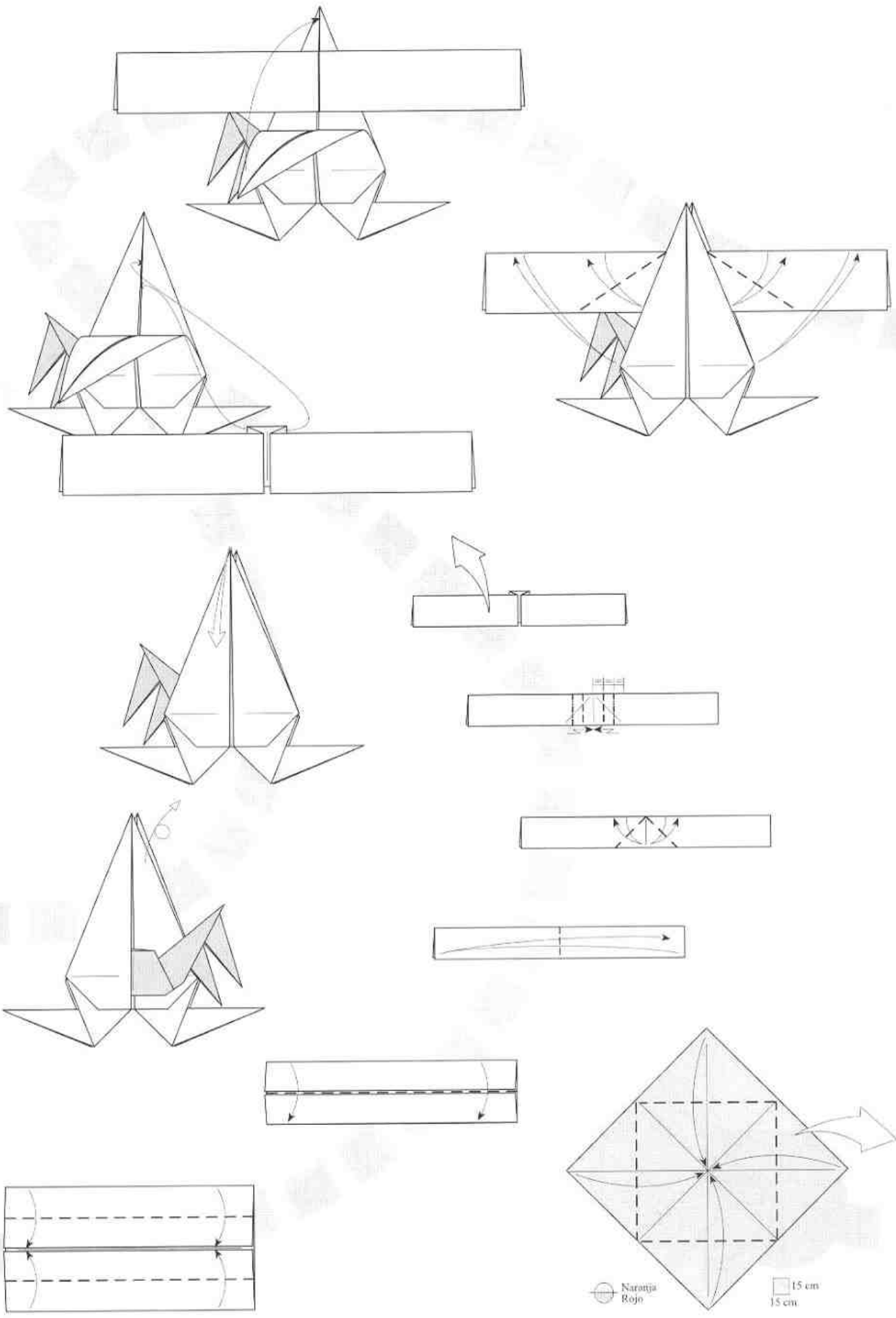

Narantja Rojo

15 cm



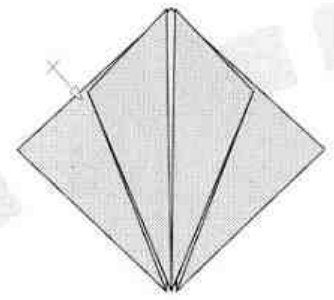
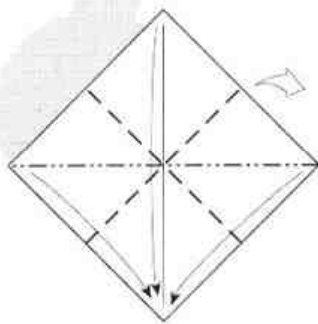
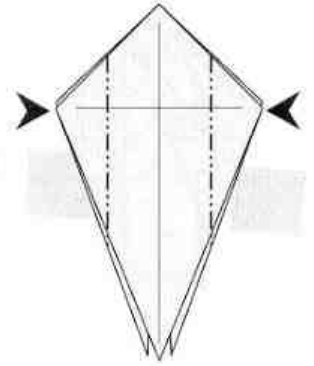
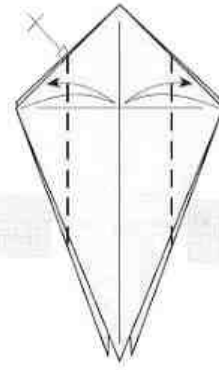
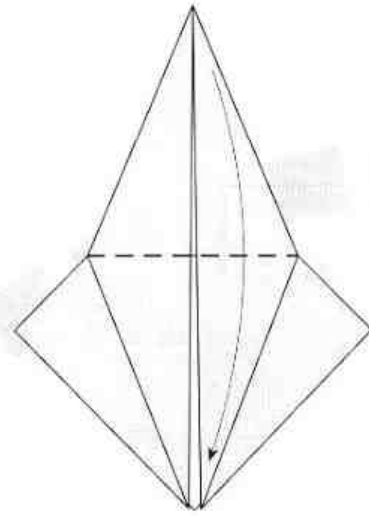
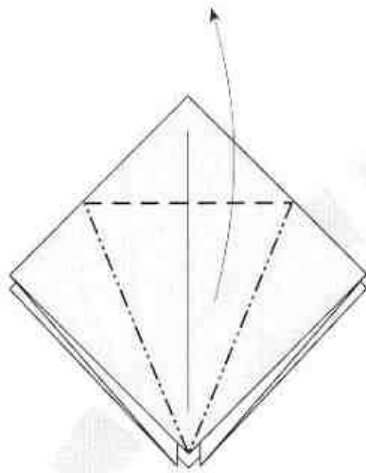
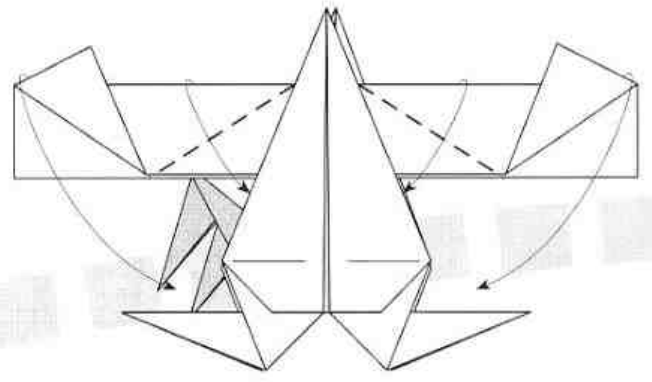
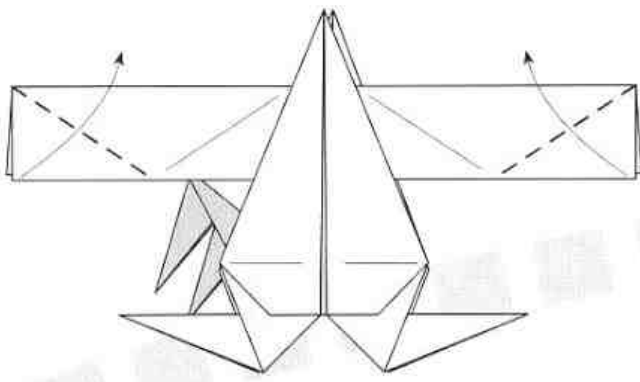

⊖ Amarillo

15 cm
15 cm

45°

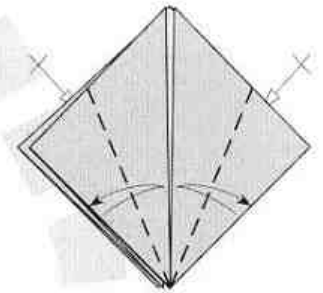
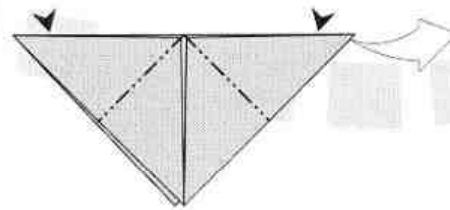
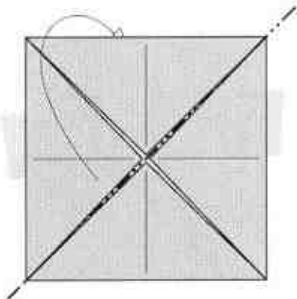

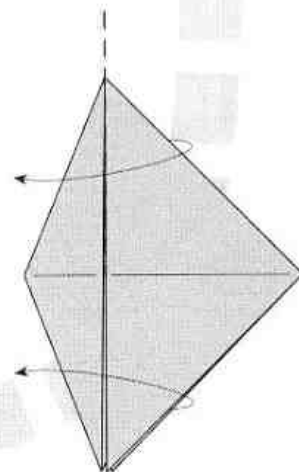
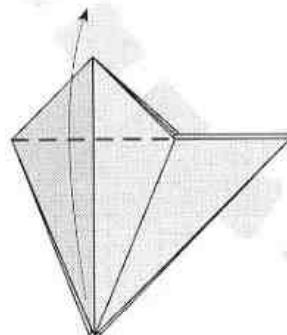
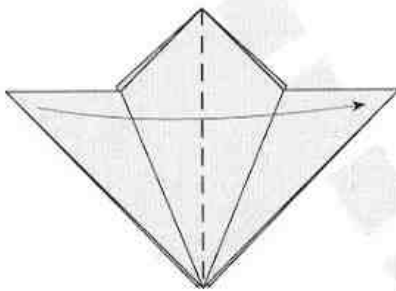
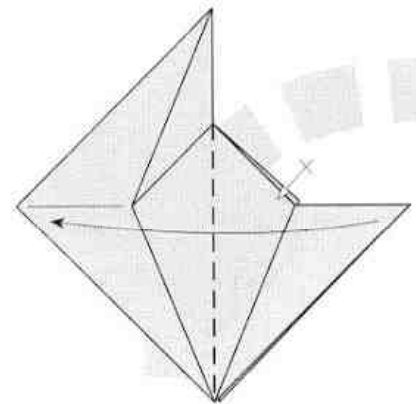
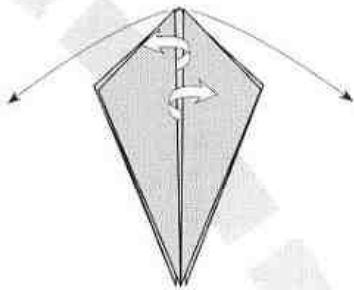
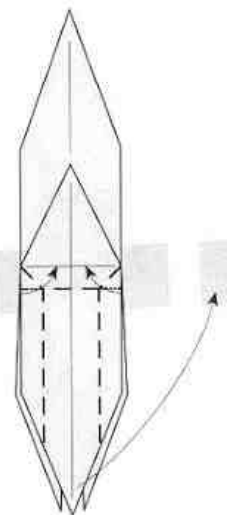
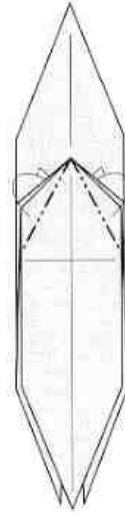
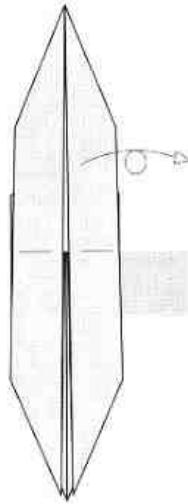
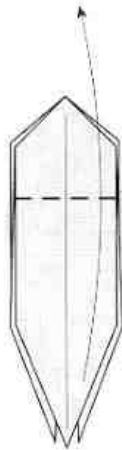
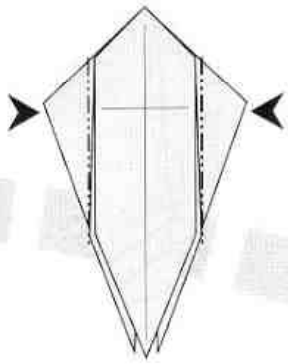
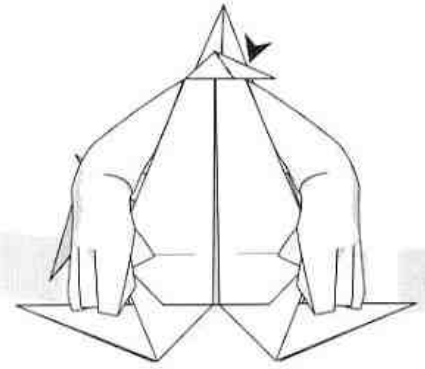
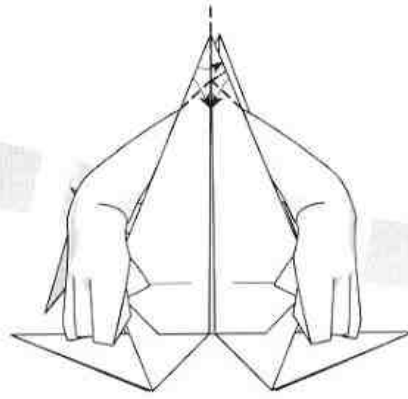
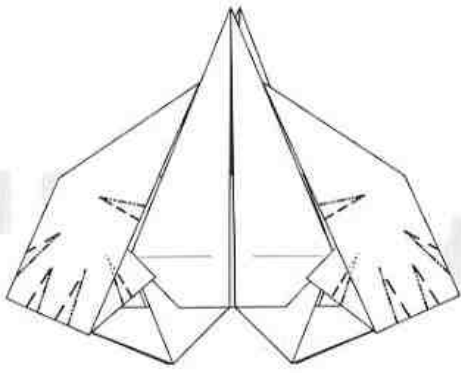

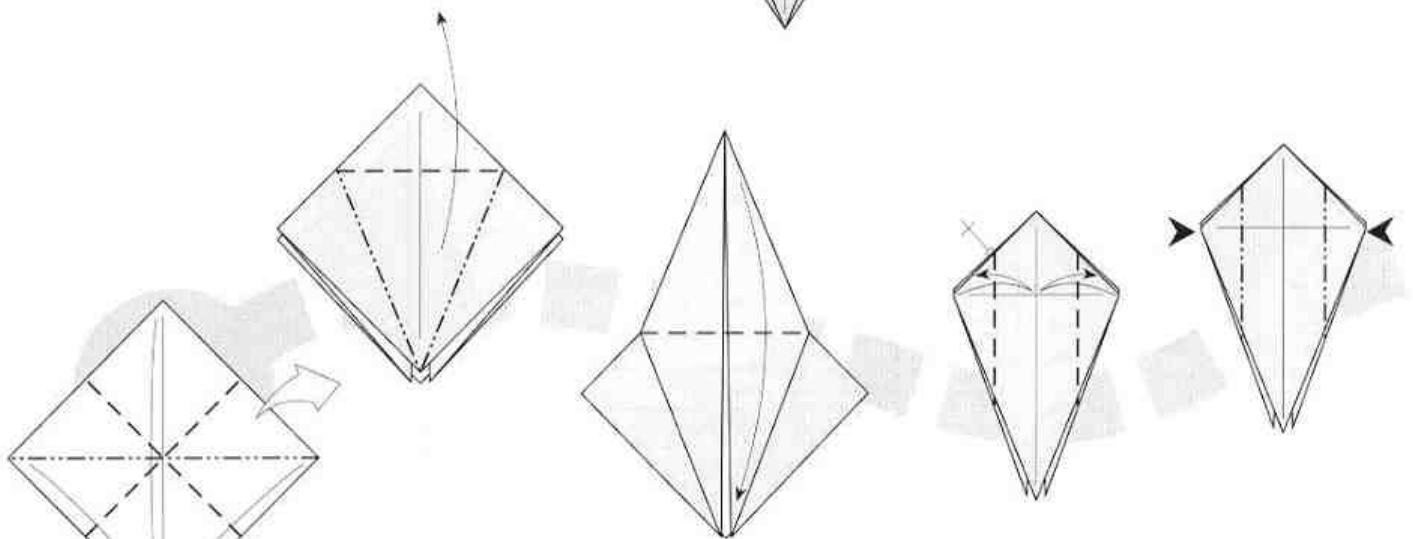
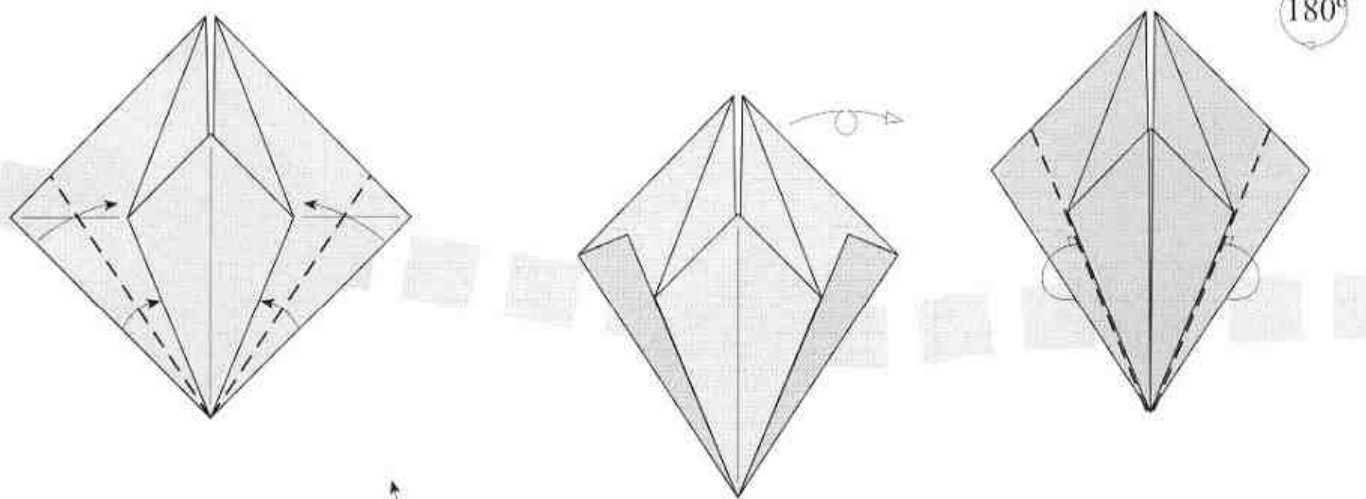
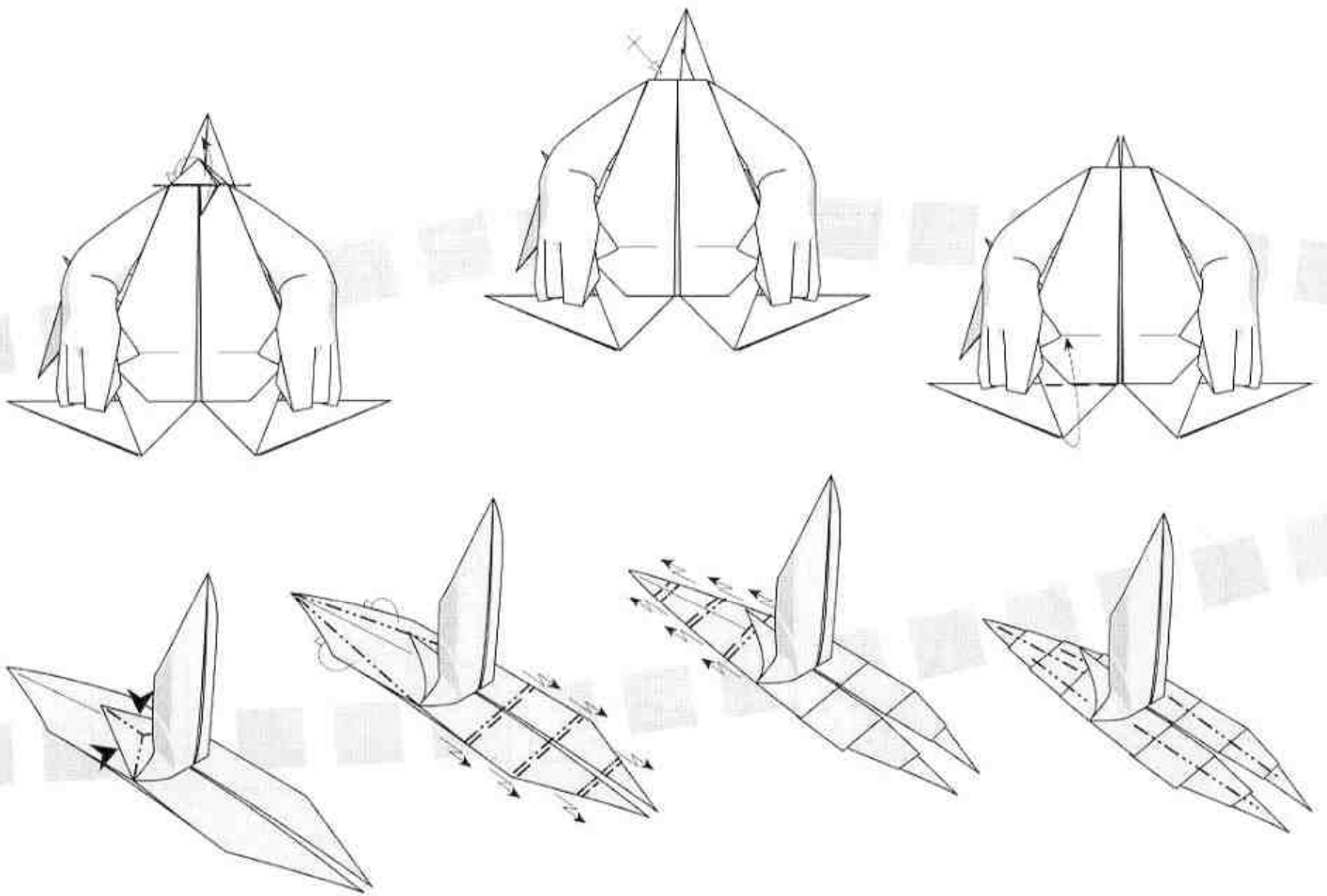

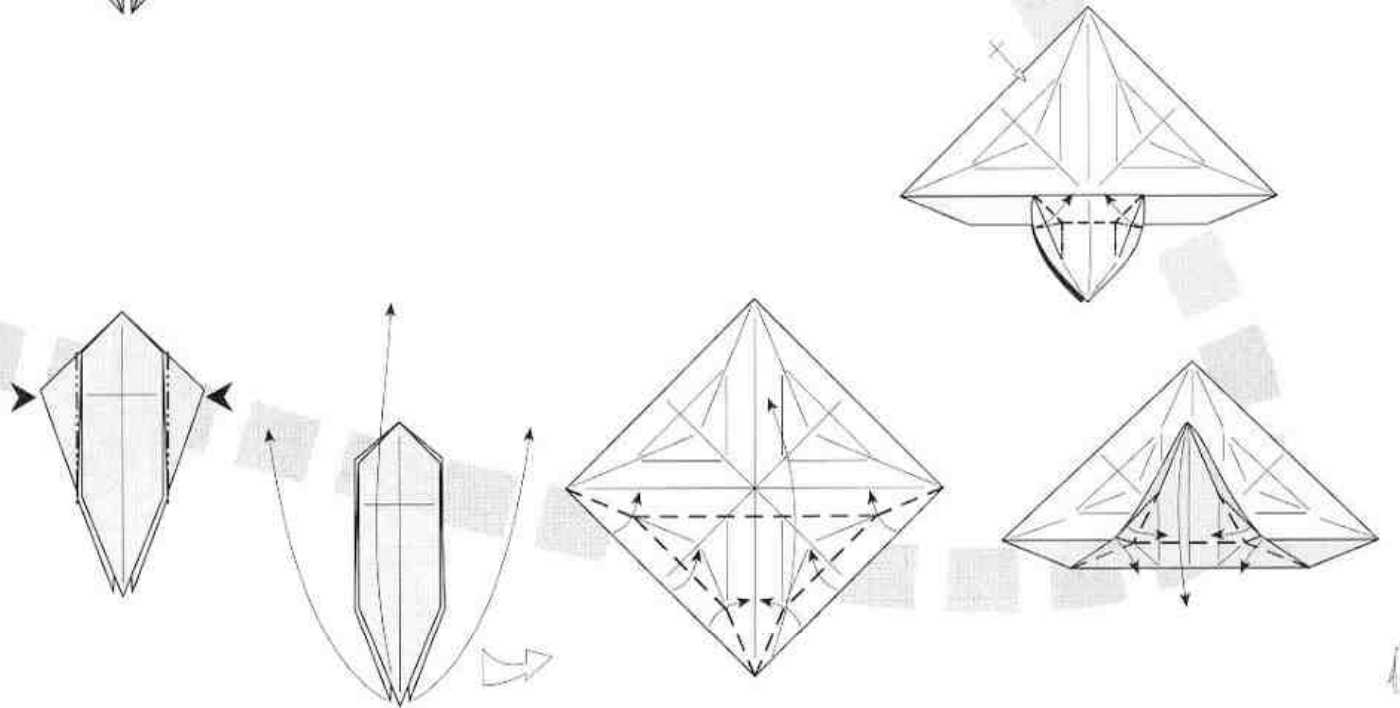
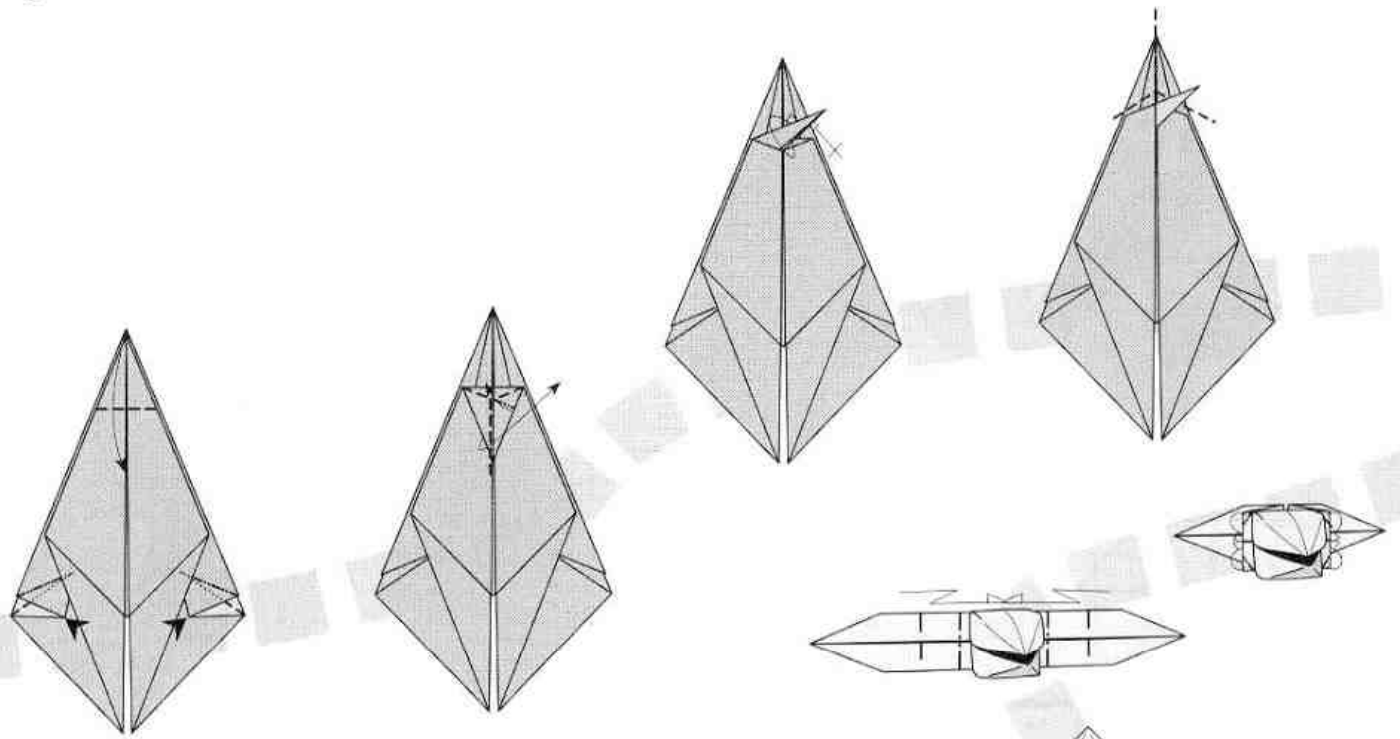
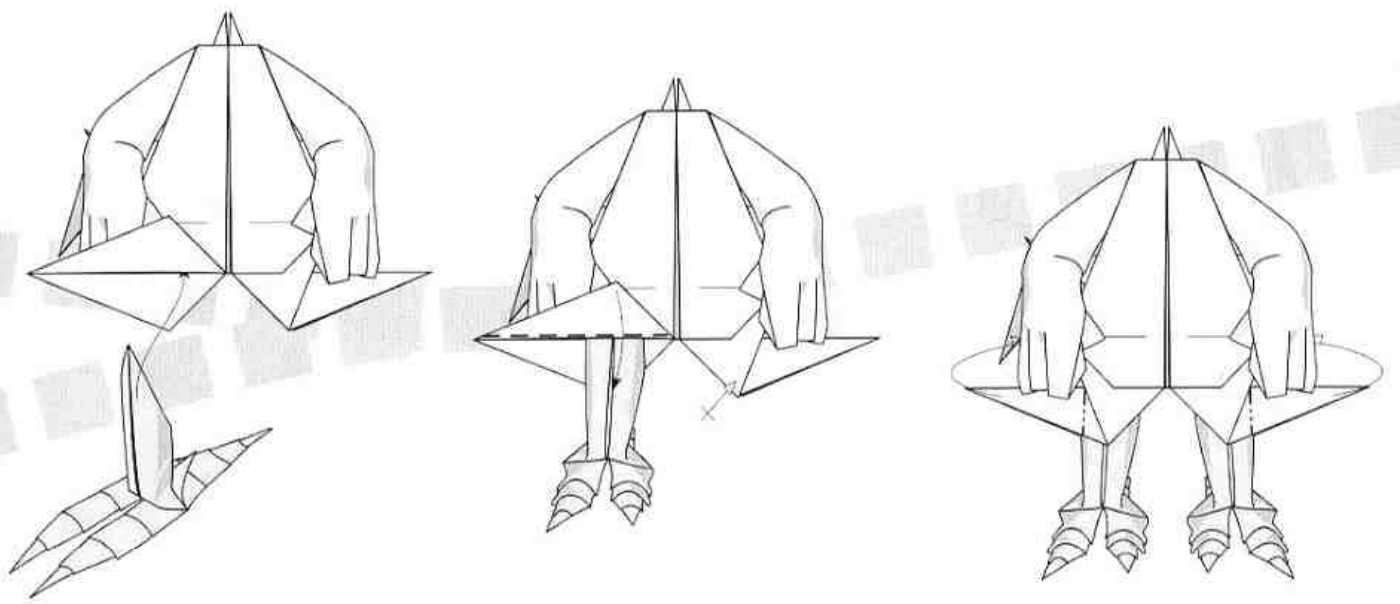

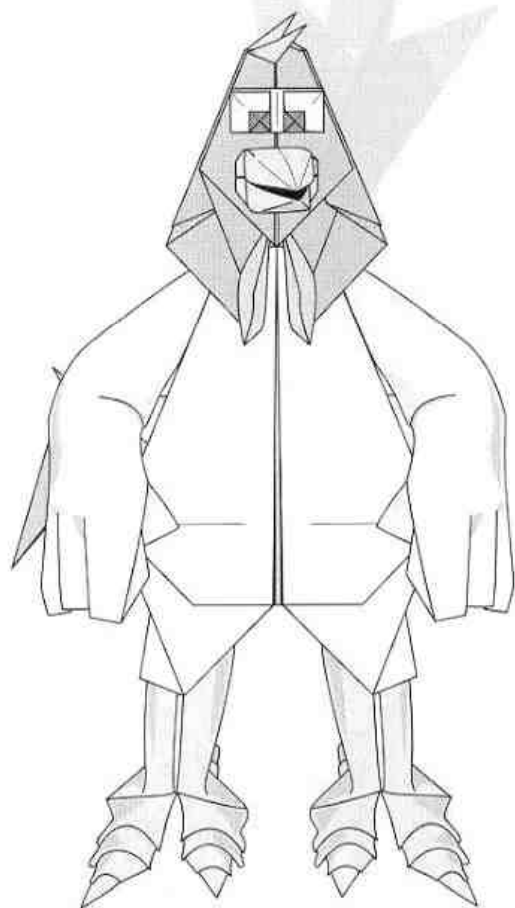
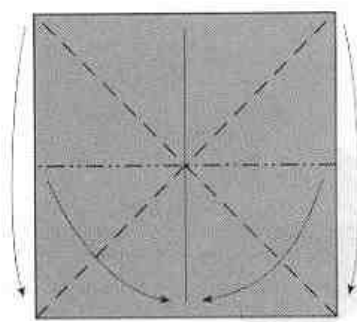
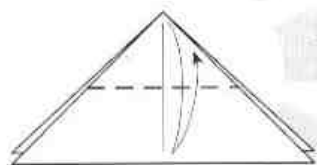
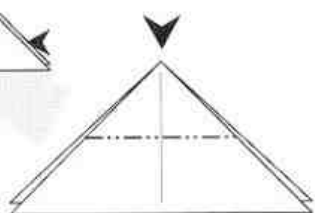
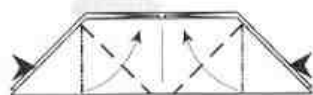
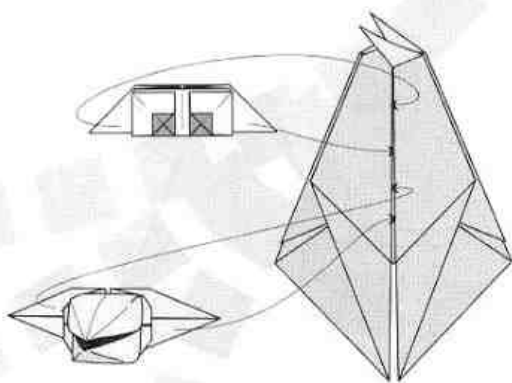
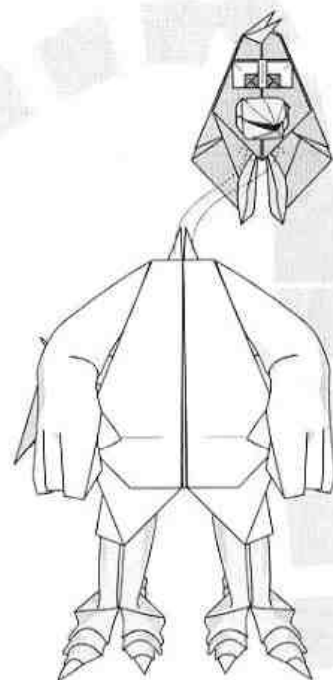
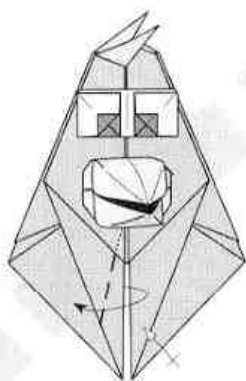
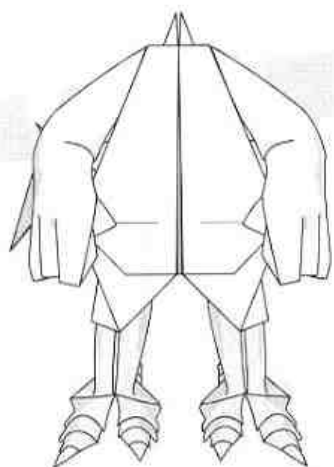

● Negro
○ Blanco

■ 5 cm
■ 5 cm

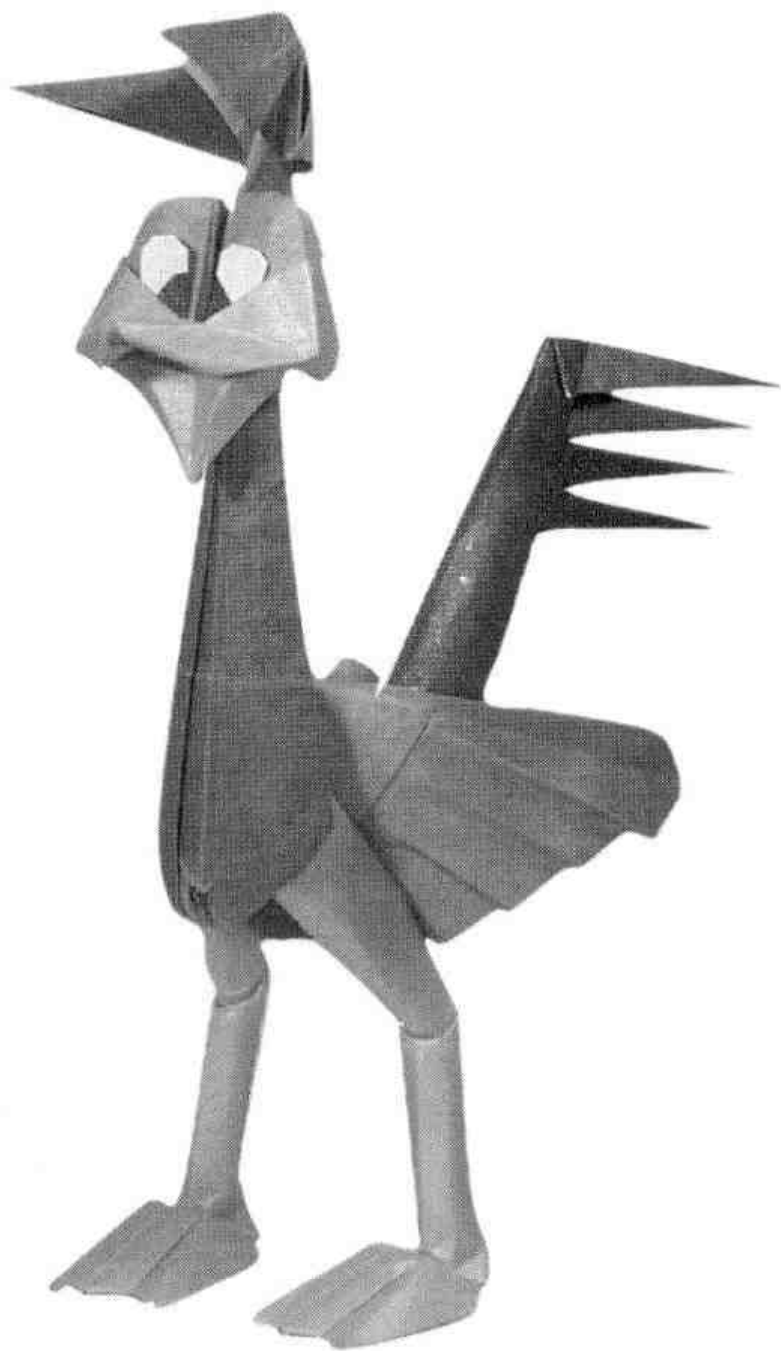



Utilizando las medidas recomendadas, se obtiene un modelo final de 22 cms.

Autor:	Halle
Nivel de dificultad:	Medio-Alto
Número de piezas:	10
Forma de las piezas:	Cuadrados

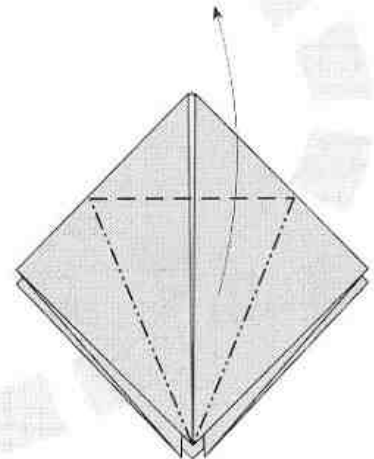
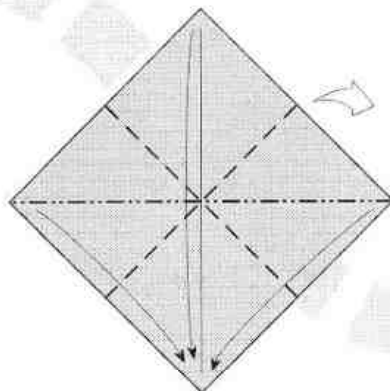
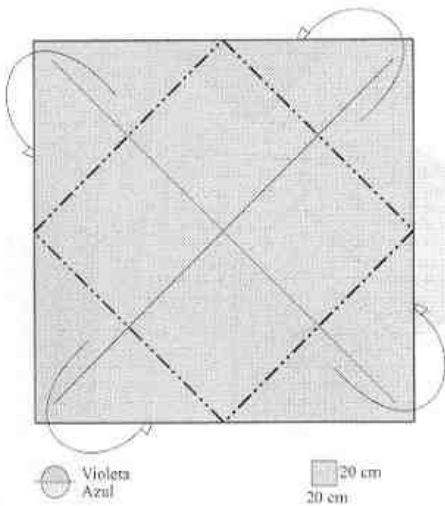
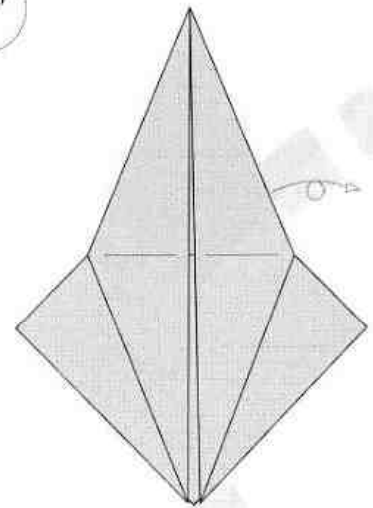
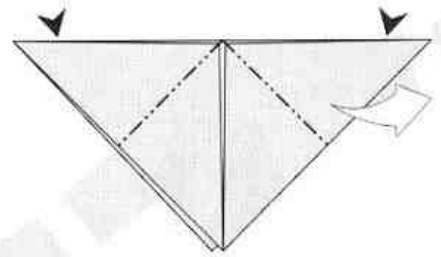
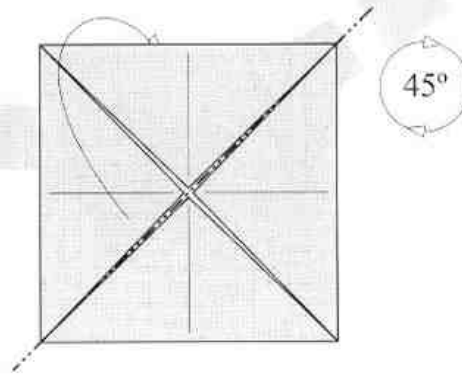
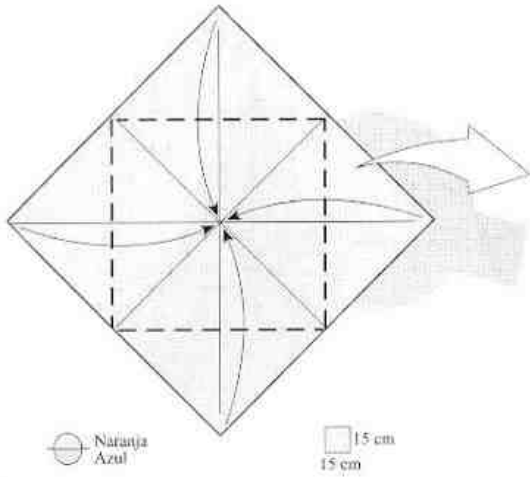

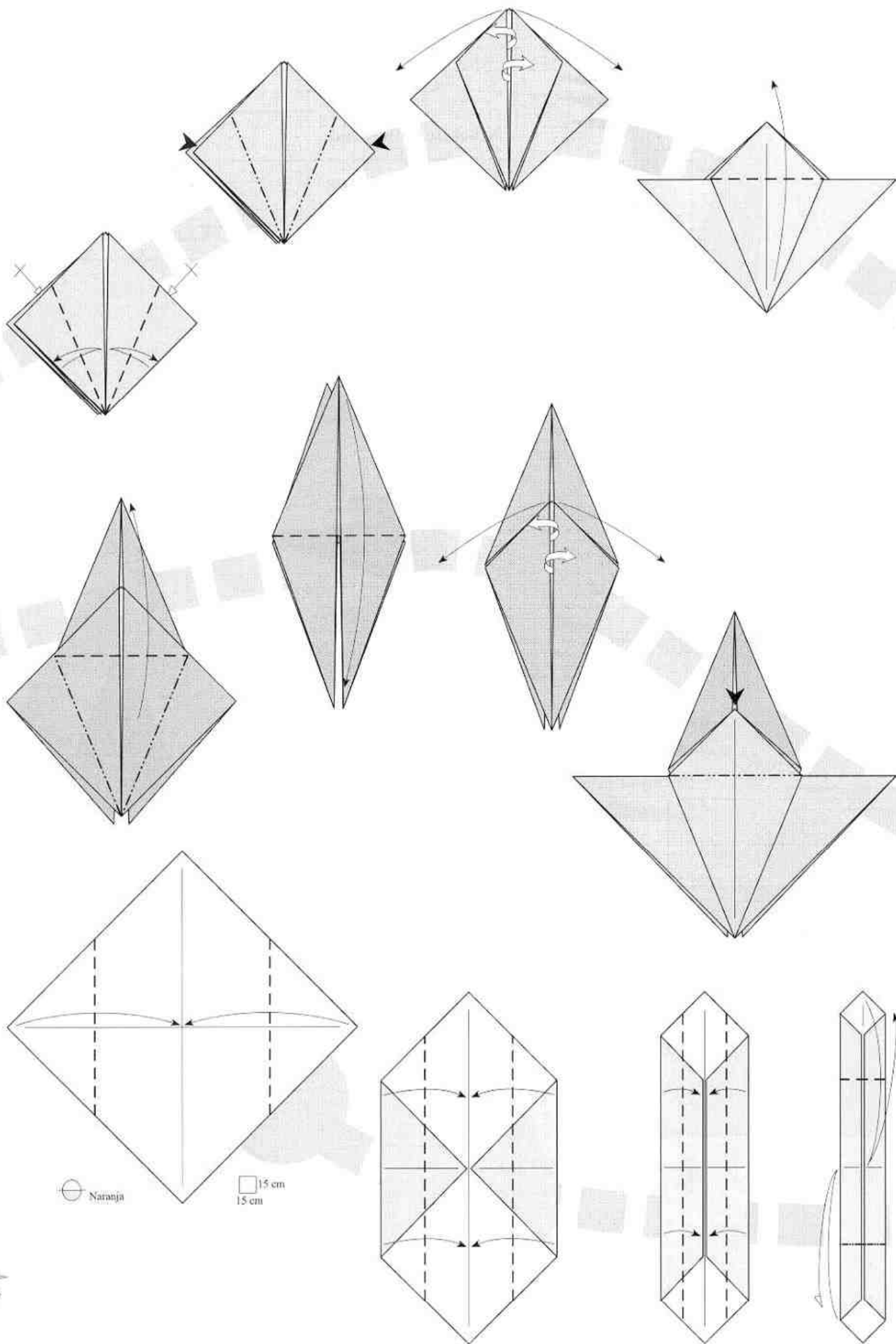

⊕ Naranja

□ 15 cm
 15 cm



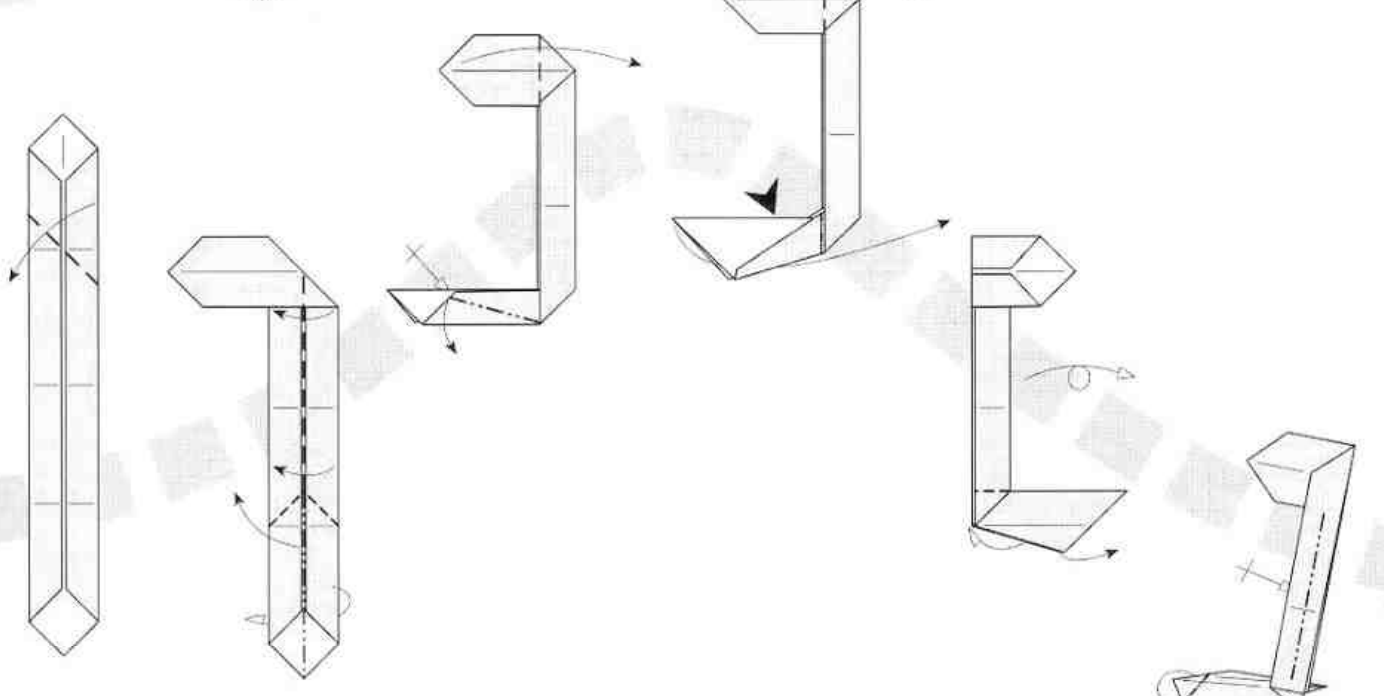
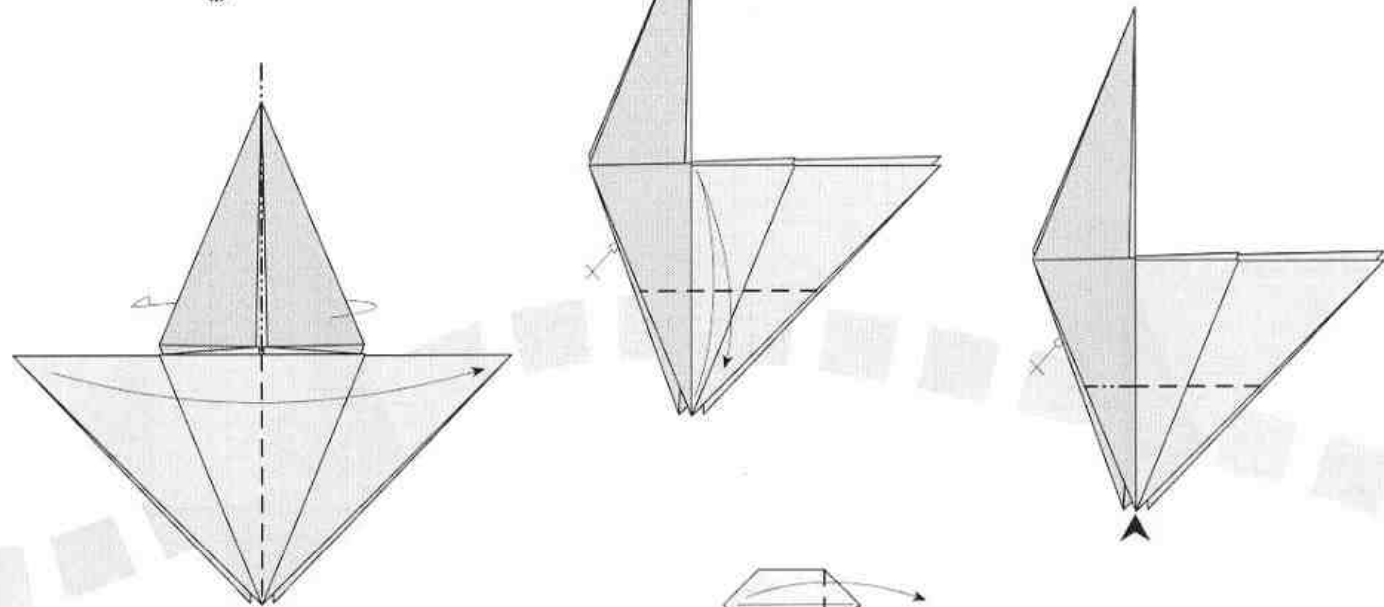
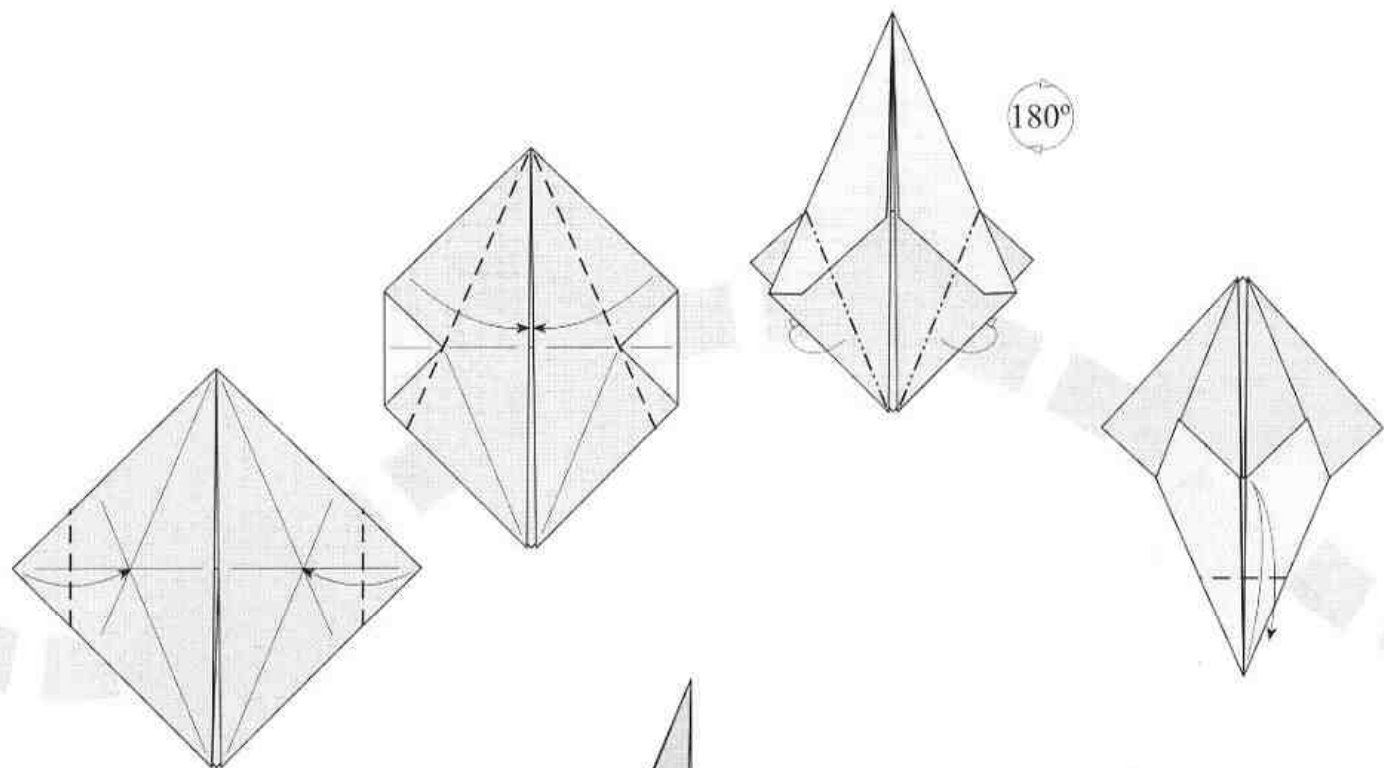

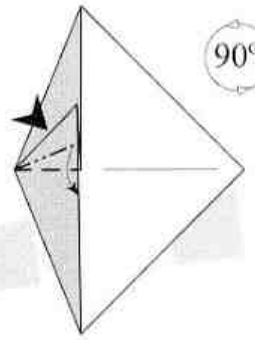
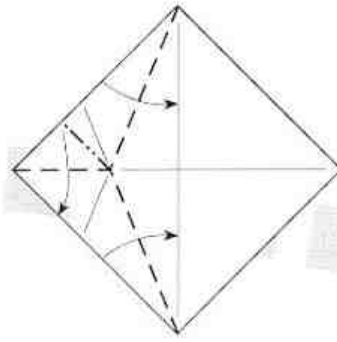
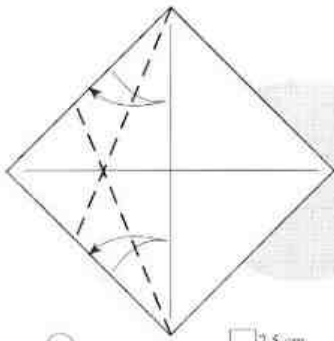

● Violeta

□ 7,5 cm
7,5 cm

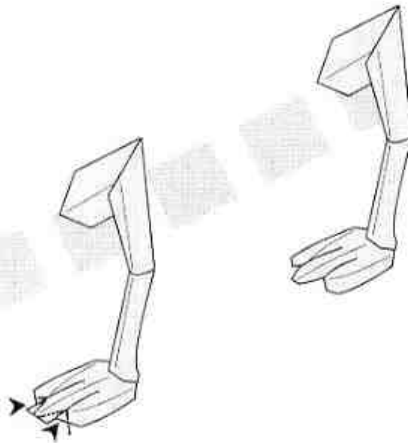
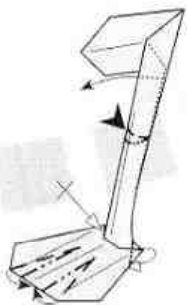
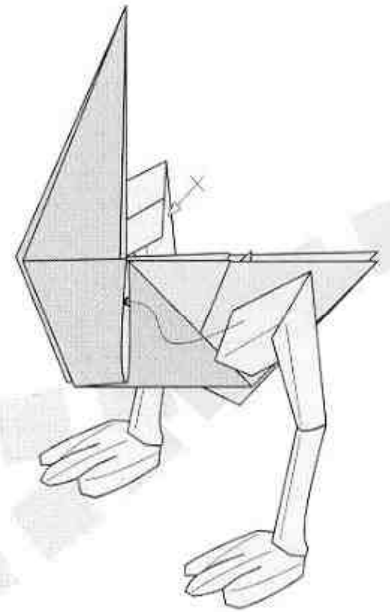
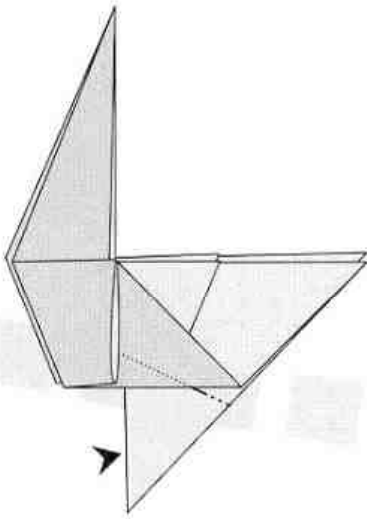
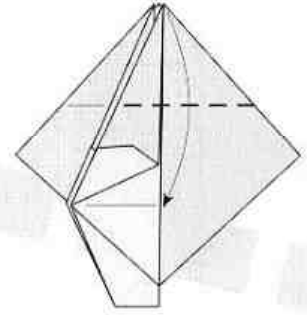
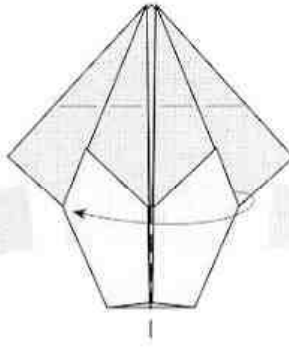
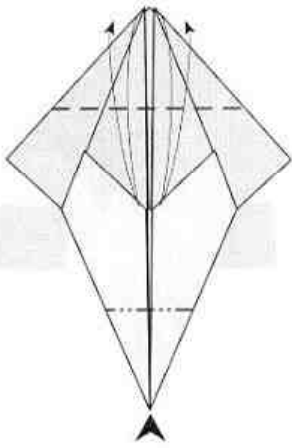

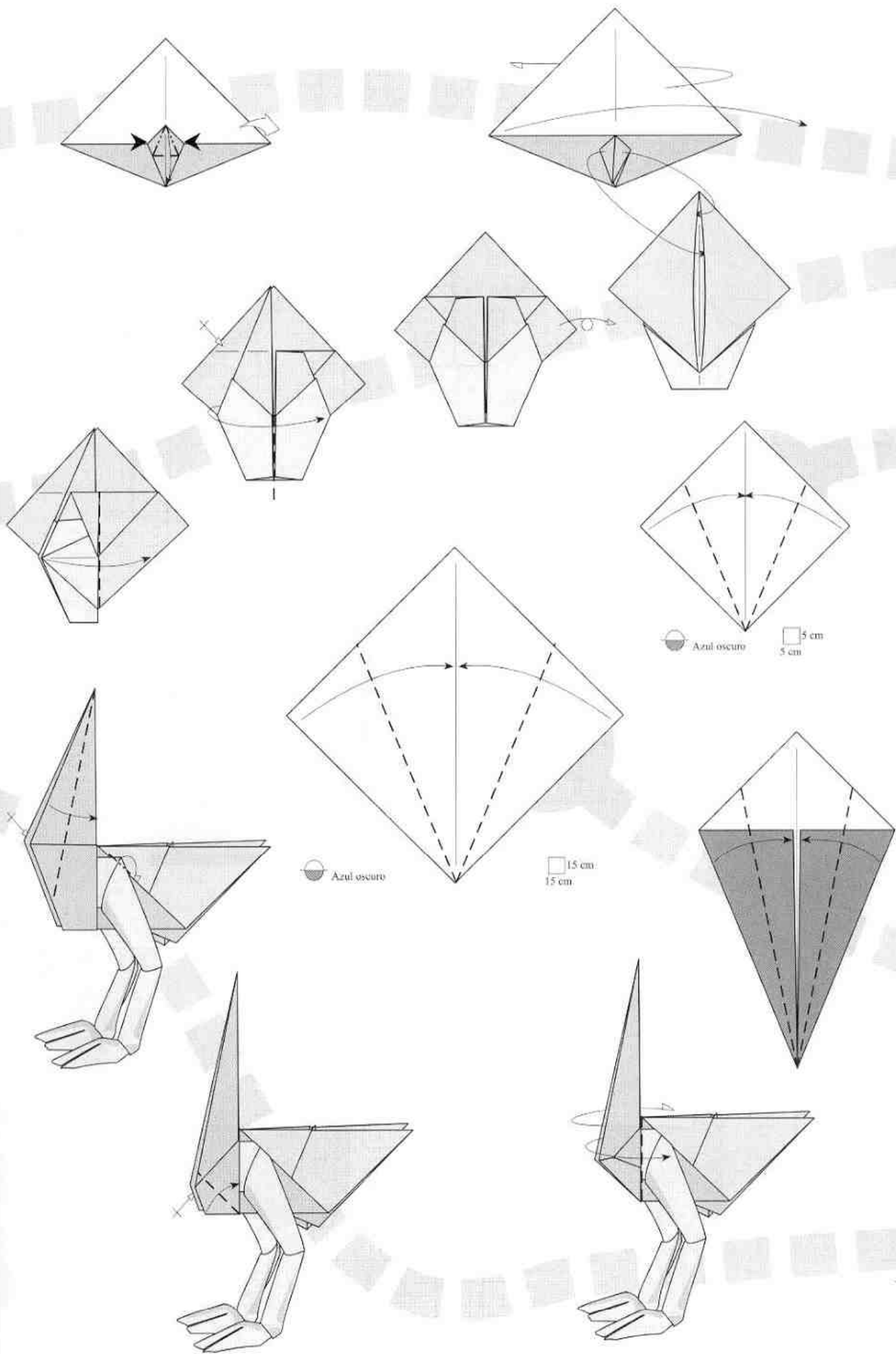

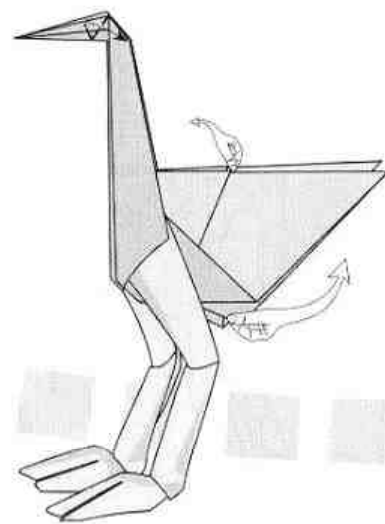
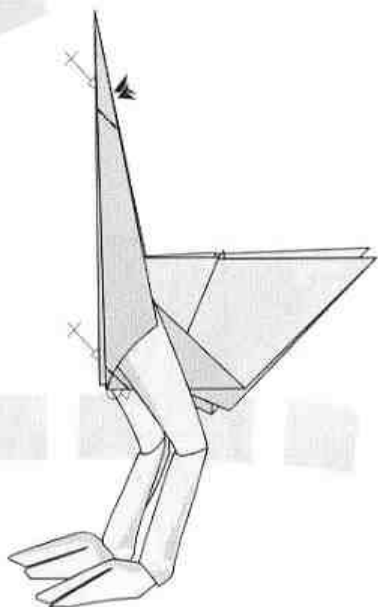
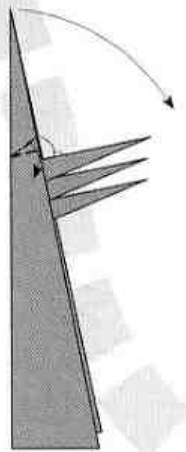
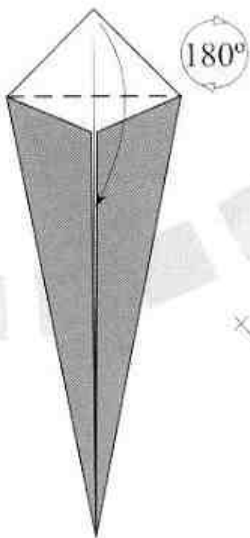
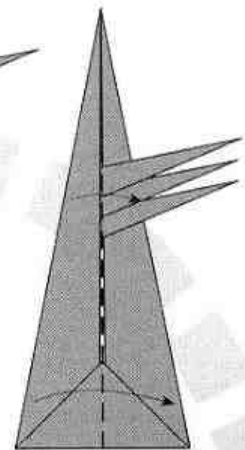
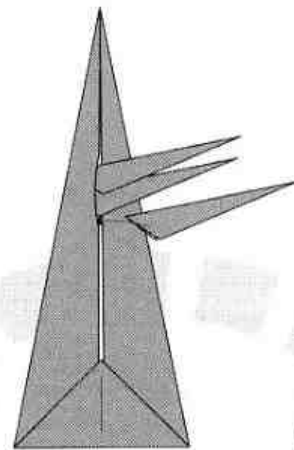
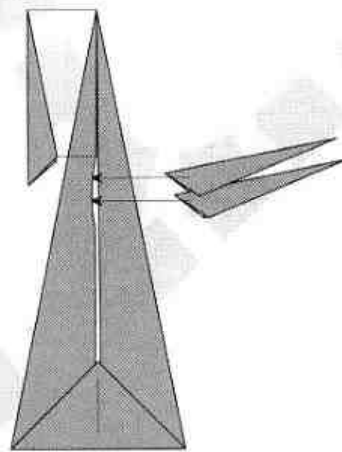
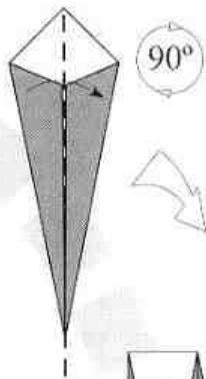
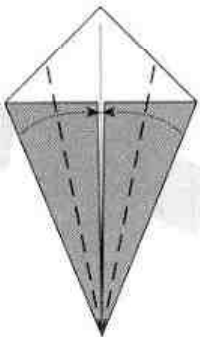
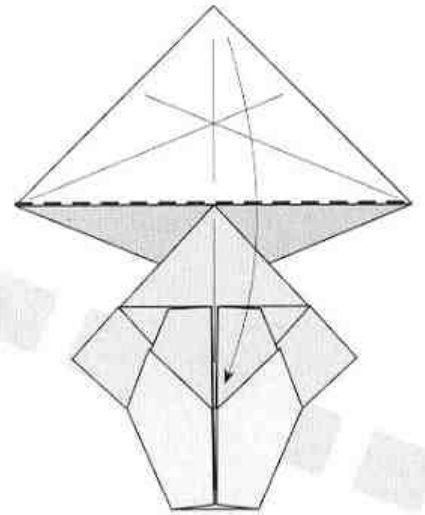
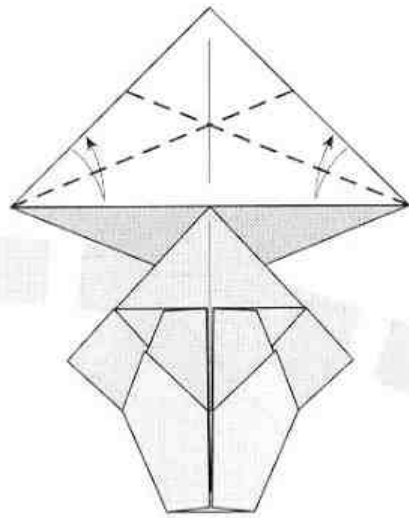
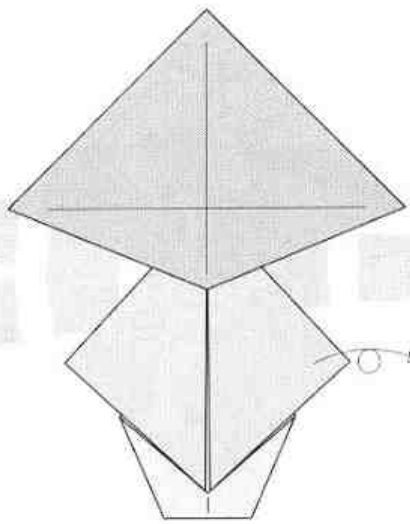

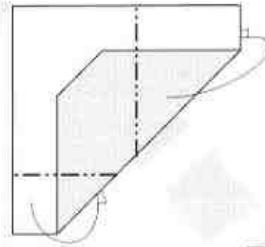
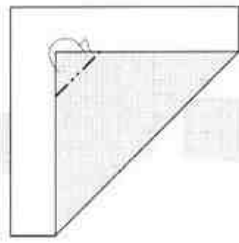
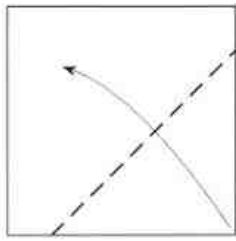

○ Blanco
○ Azul

□ 2 cm
□ 2 cm

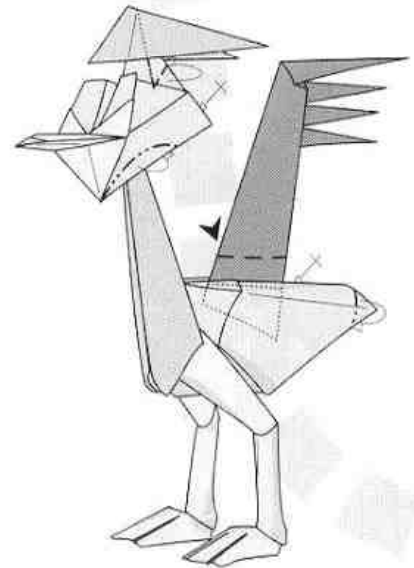
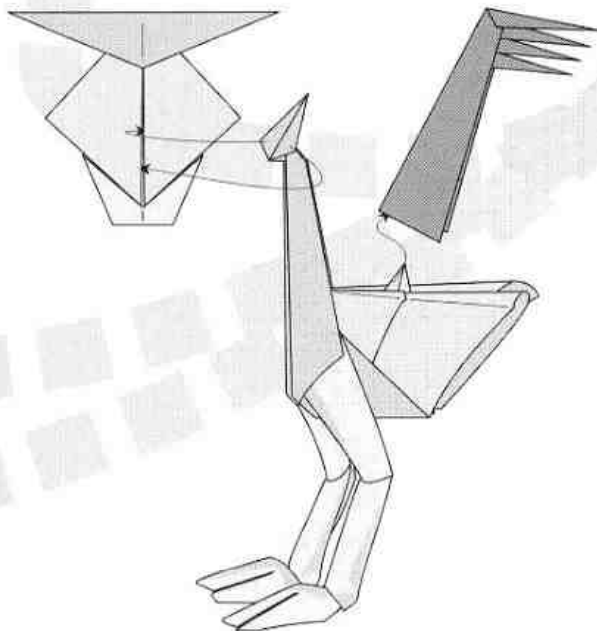
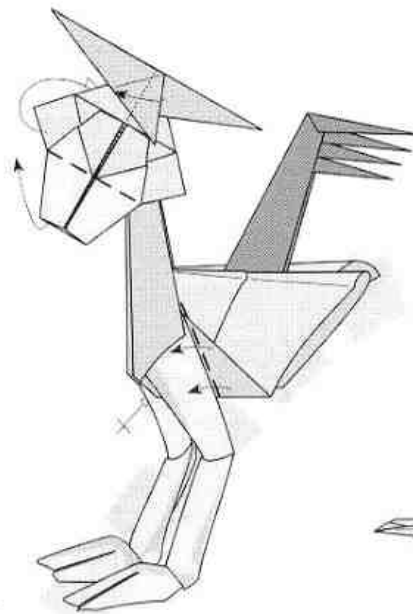
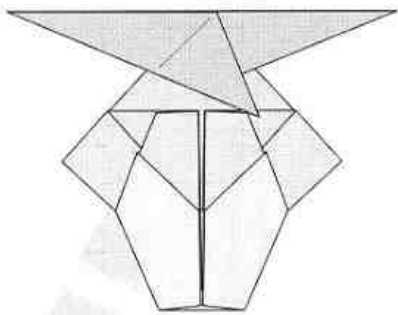
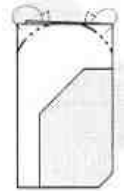
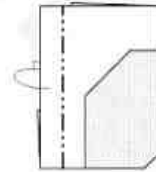
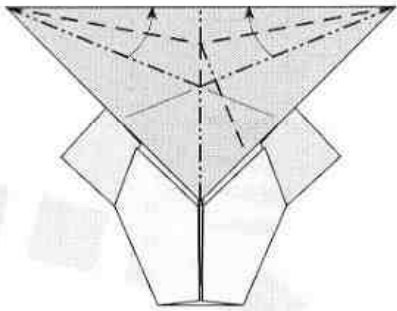

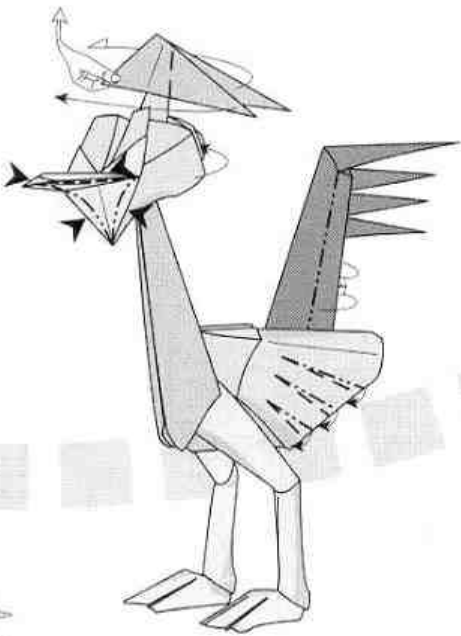
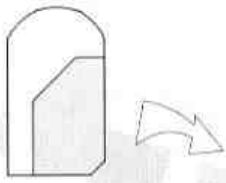

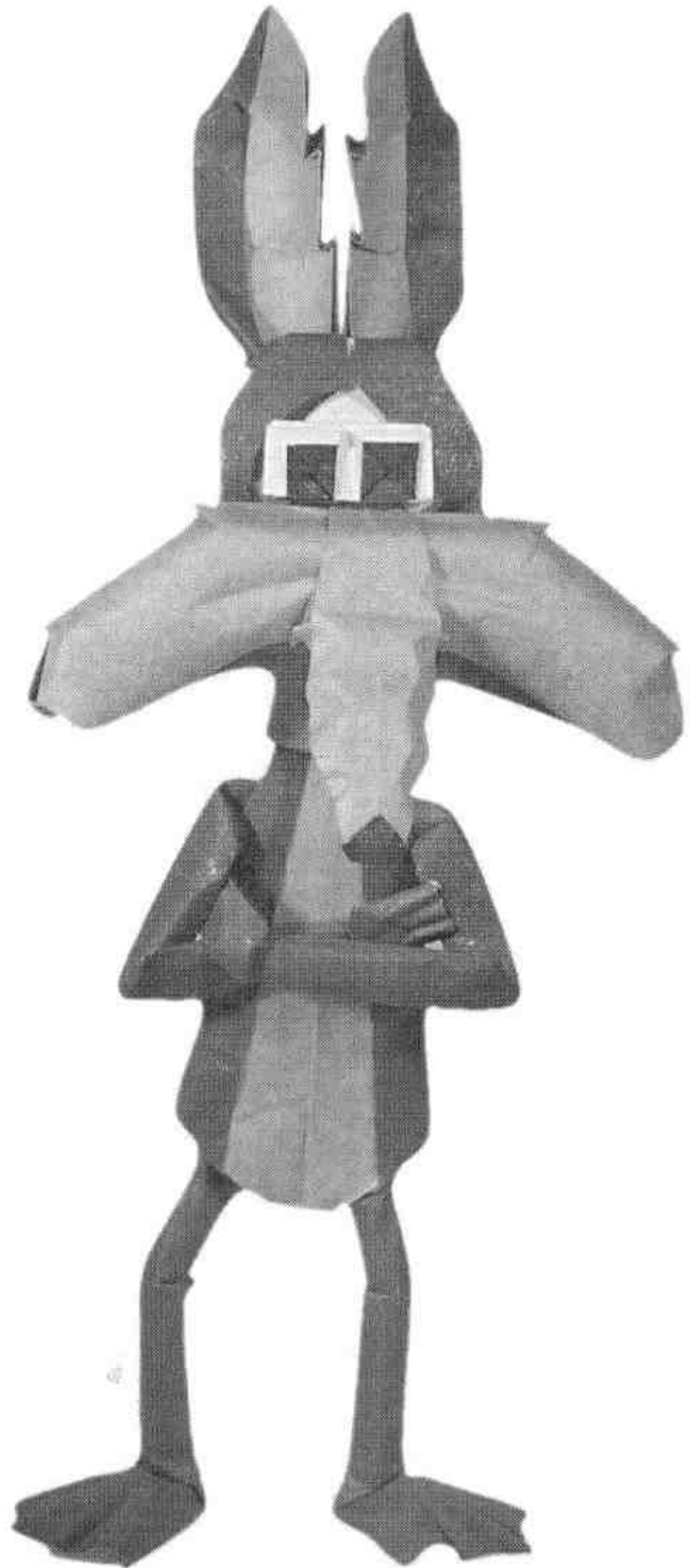

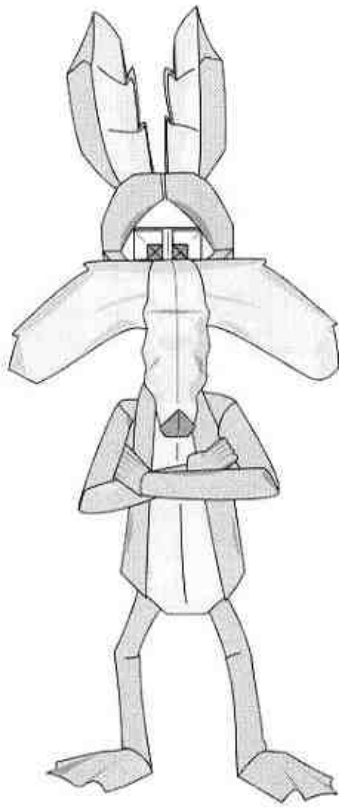

Utilizando las medidas recomendadas, se obtiene un modelo final de 27 cms.	
Autor:	Halle
Nivel de dificultad:	Medio-Alto
Número de piezas:	9
Forma de las piezas:	Cuadrados

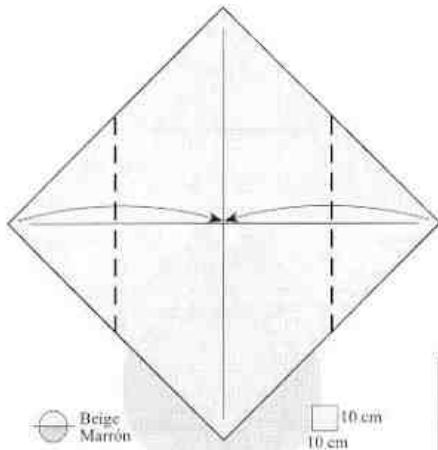

● Beige
● Marrón

□ 10 cm
□ 10 cm

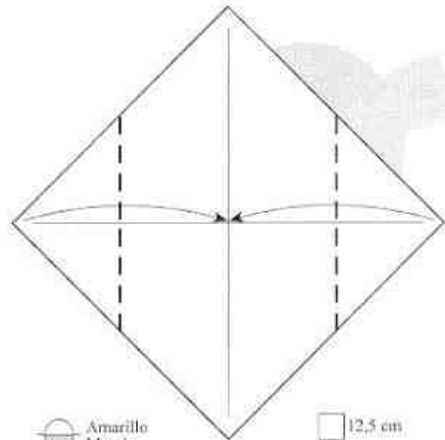
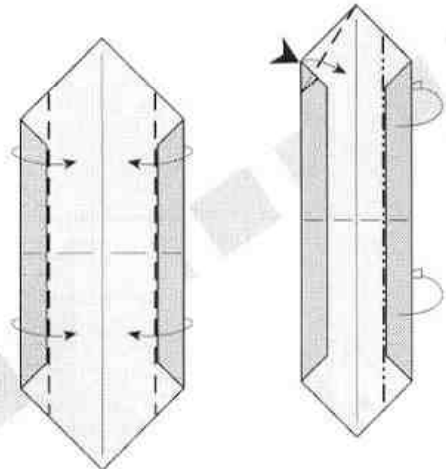
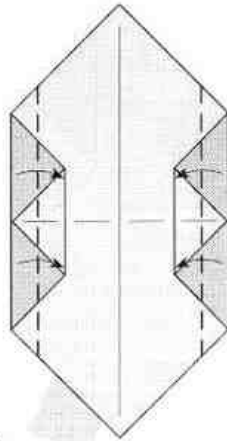
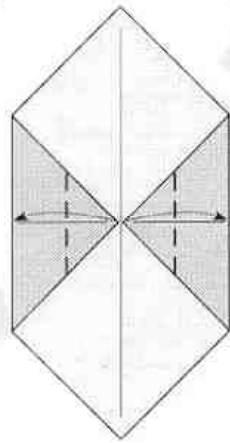

● Amarillo
● Marrón

□ 12,5 cm
□ 12,5 cm

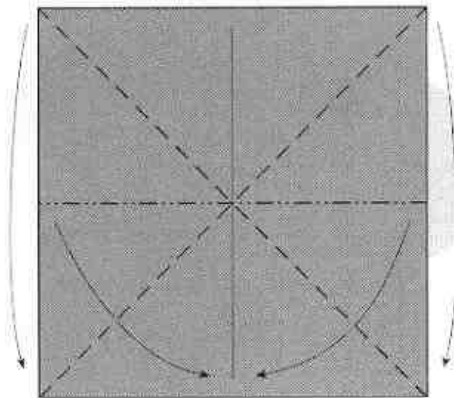

● Negro
● Beige

□ 15 cm
□ 15 cm

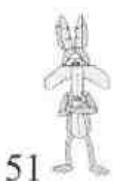
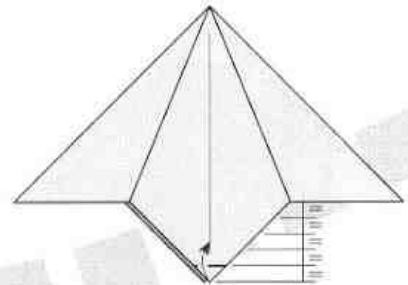
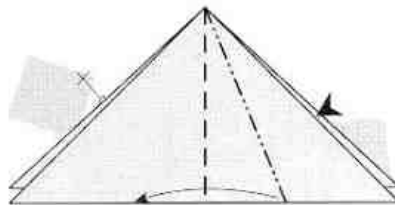

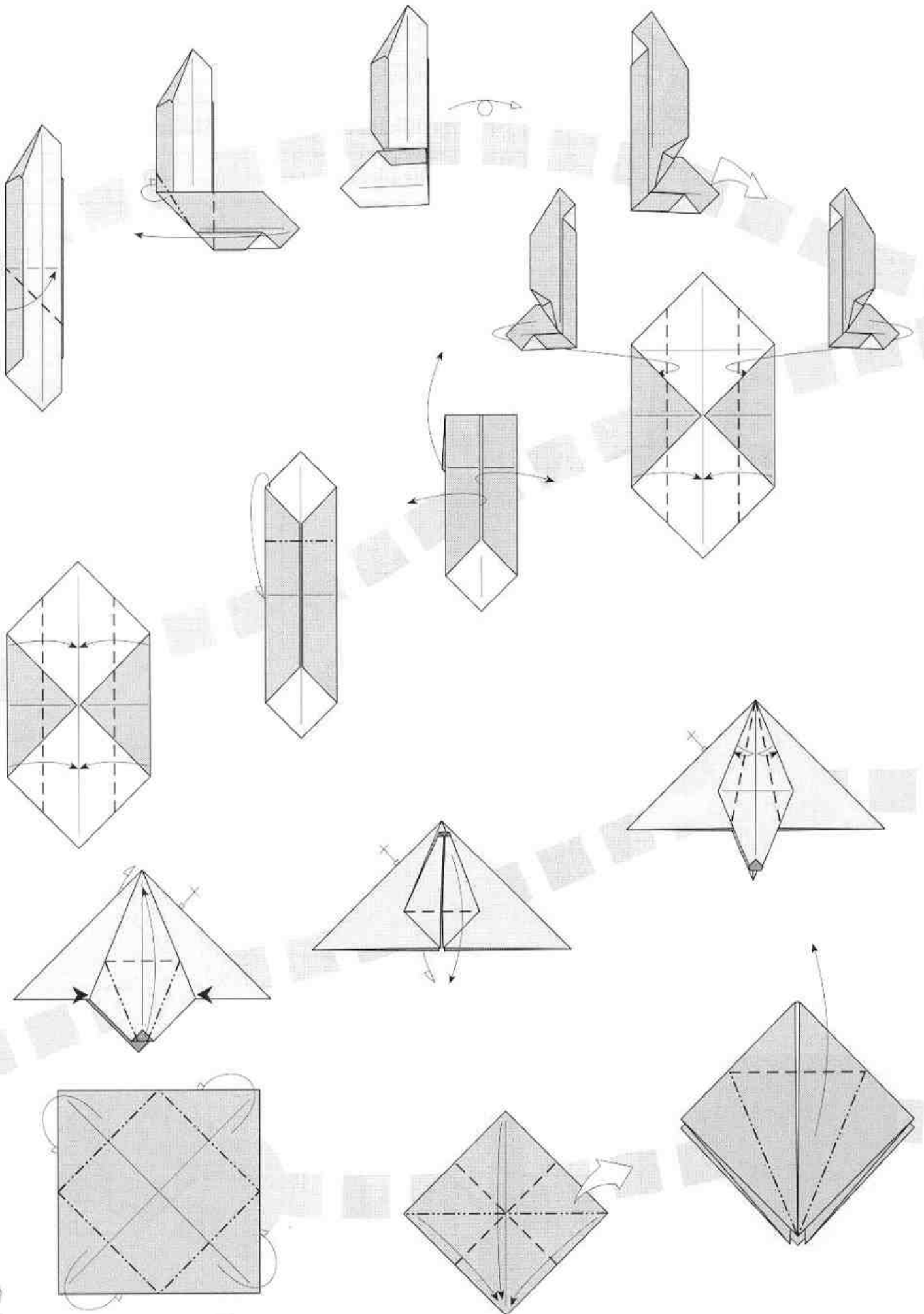

Marrón
 Beige
 25 cm
 25 cm

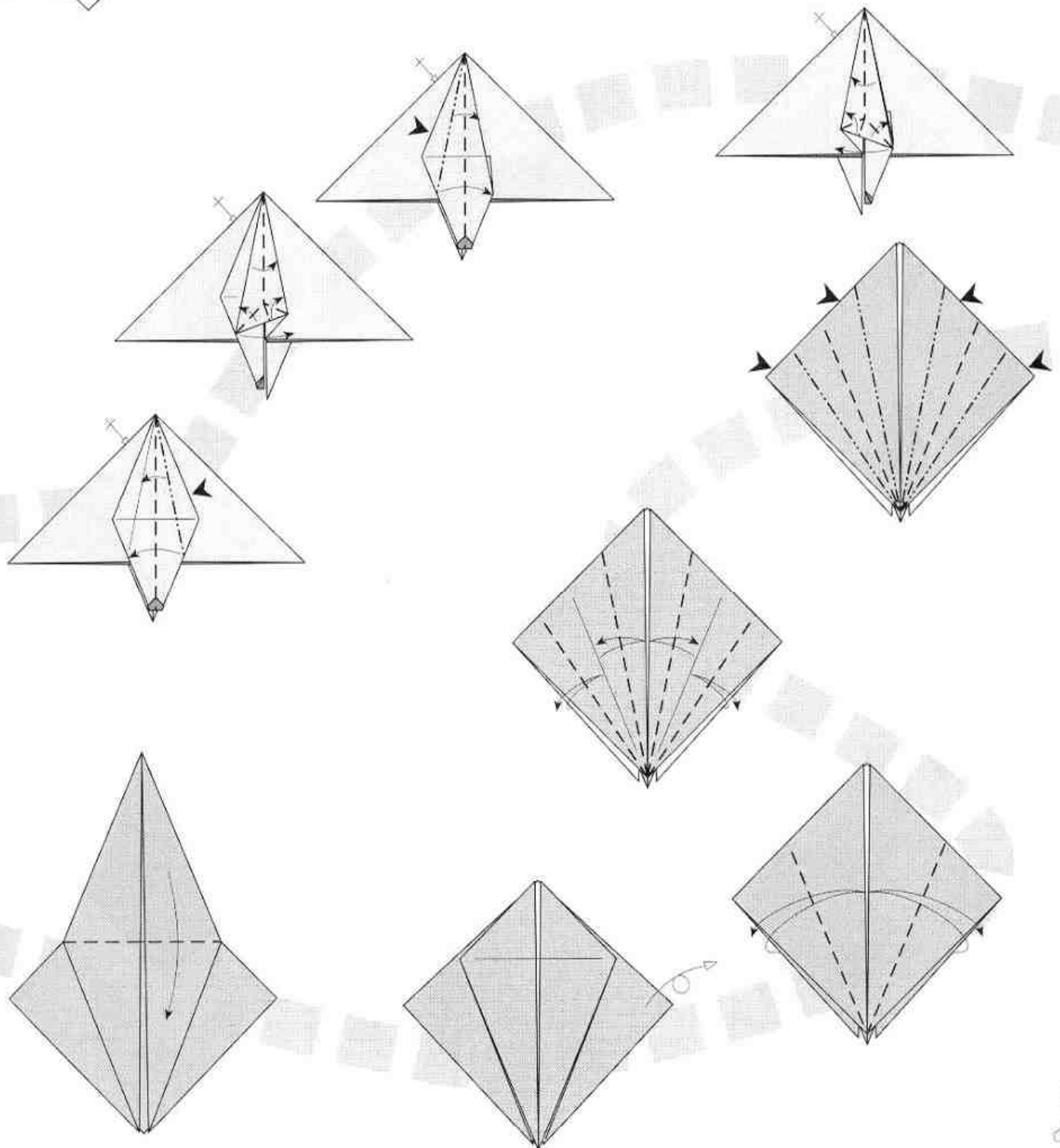
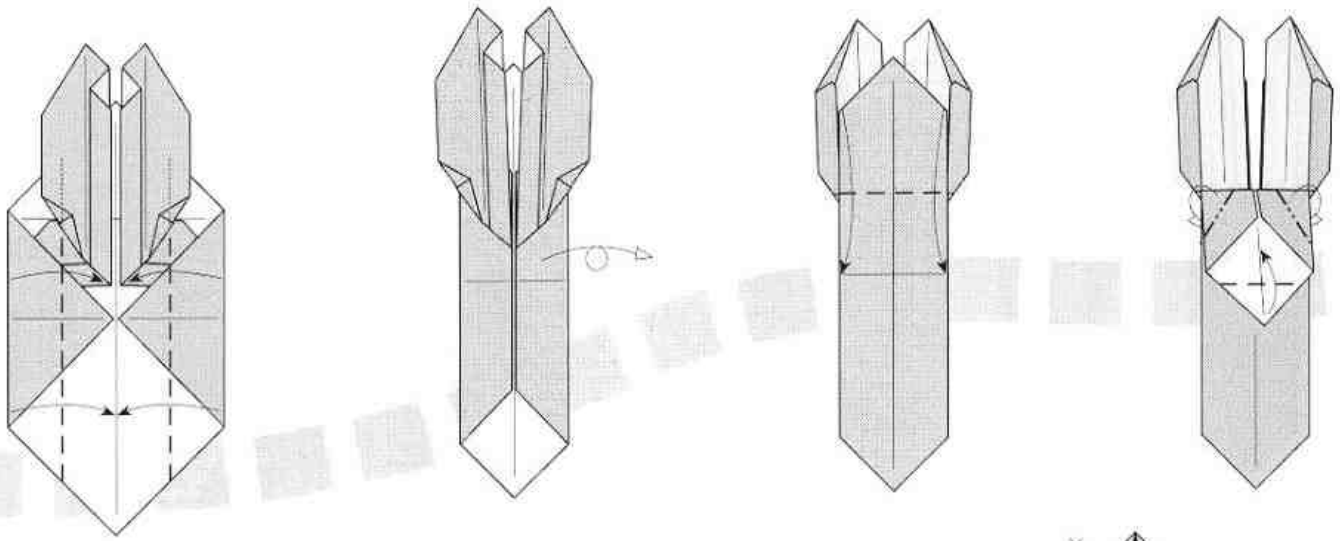

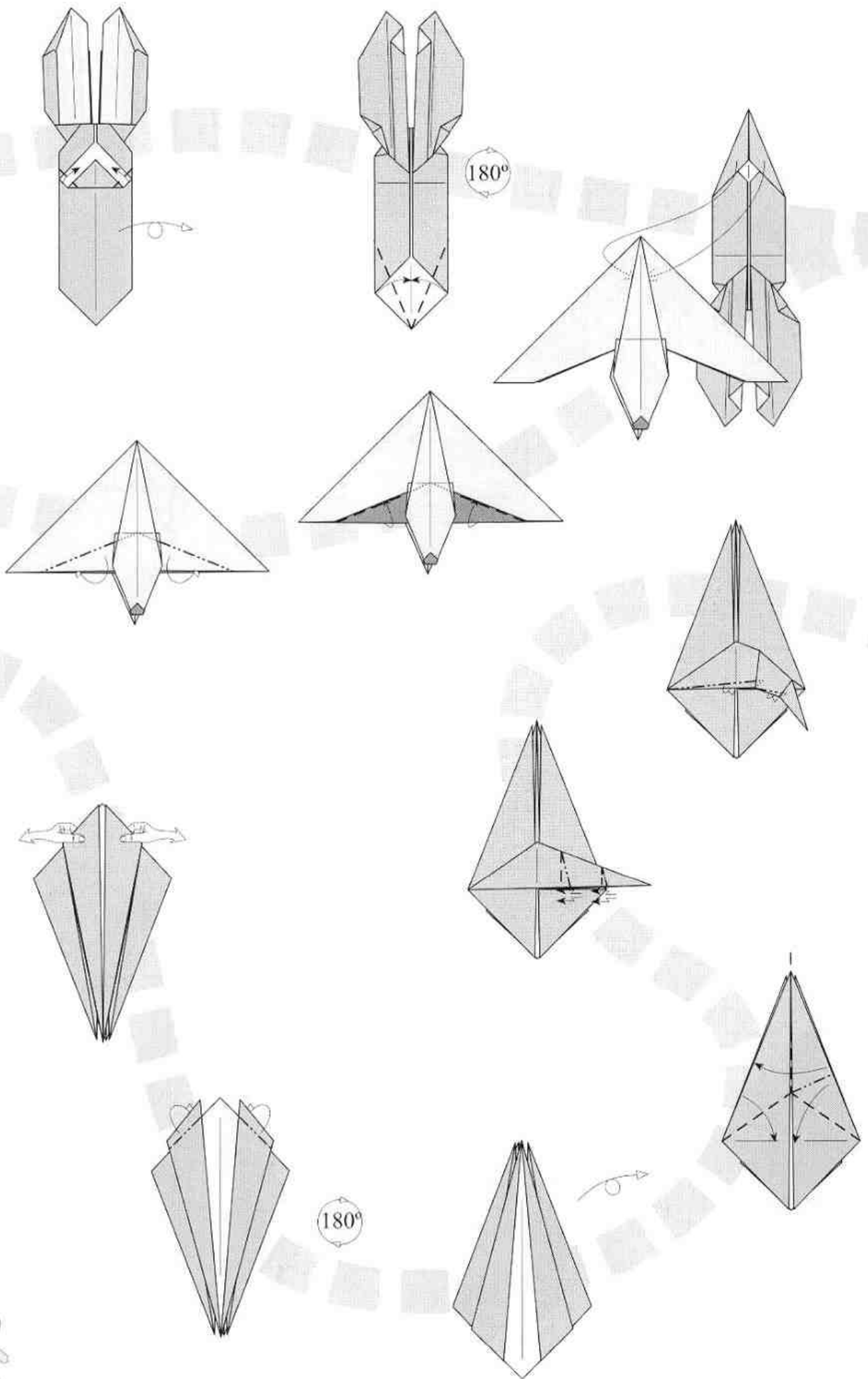

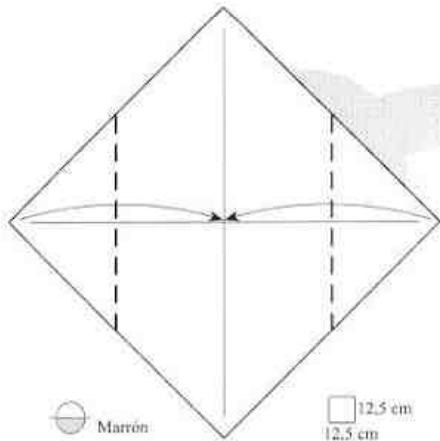
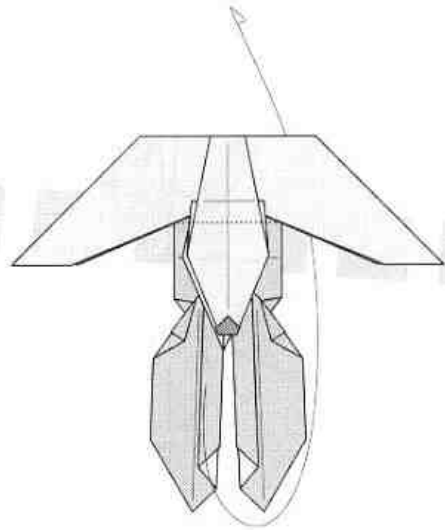
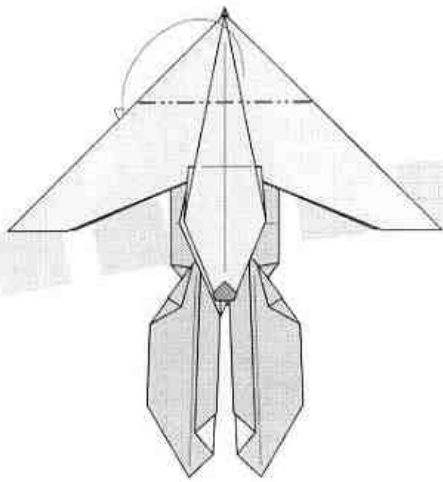

12,5 cm
12,5 cm

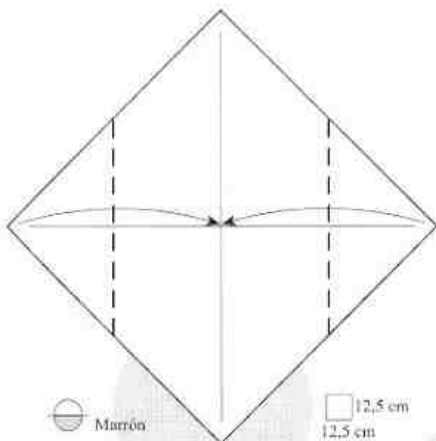
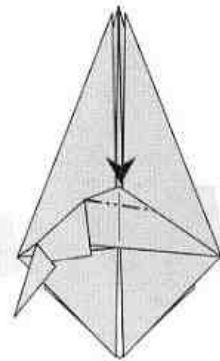
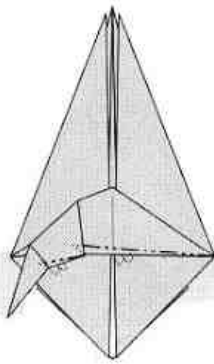
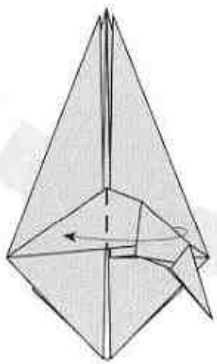
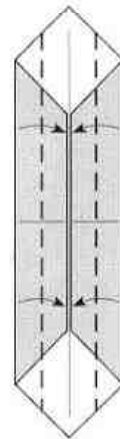
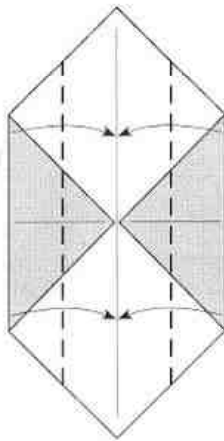

12,5 cm
12,5 cm

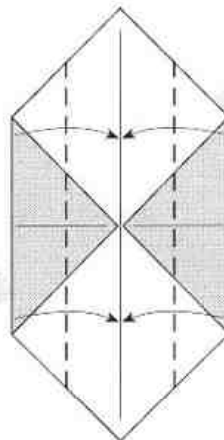

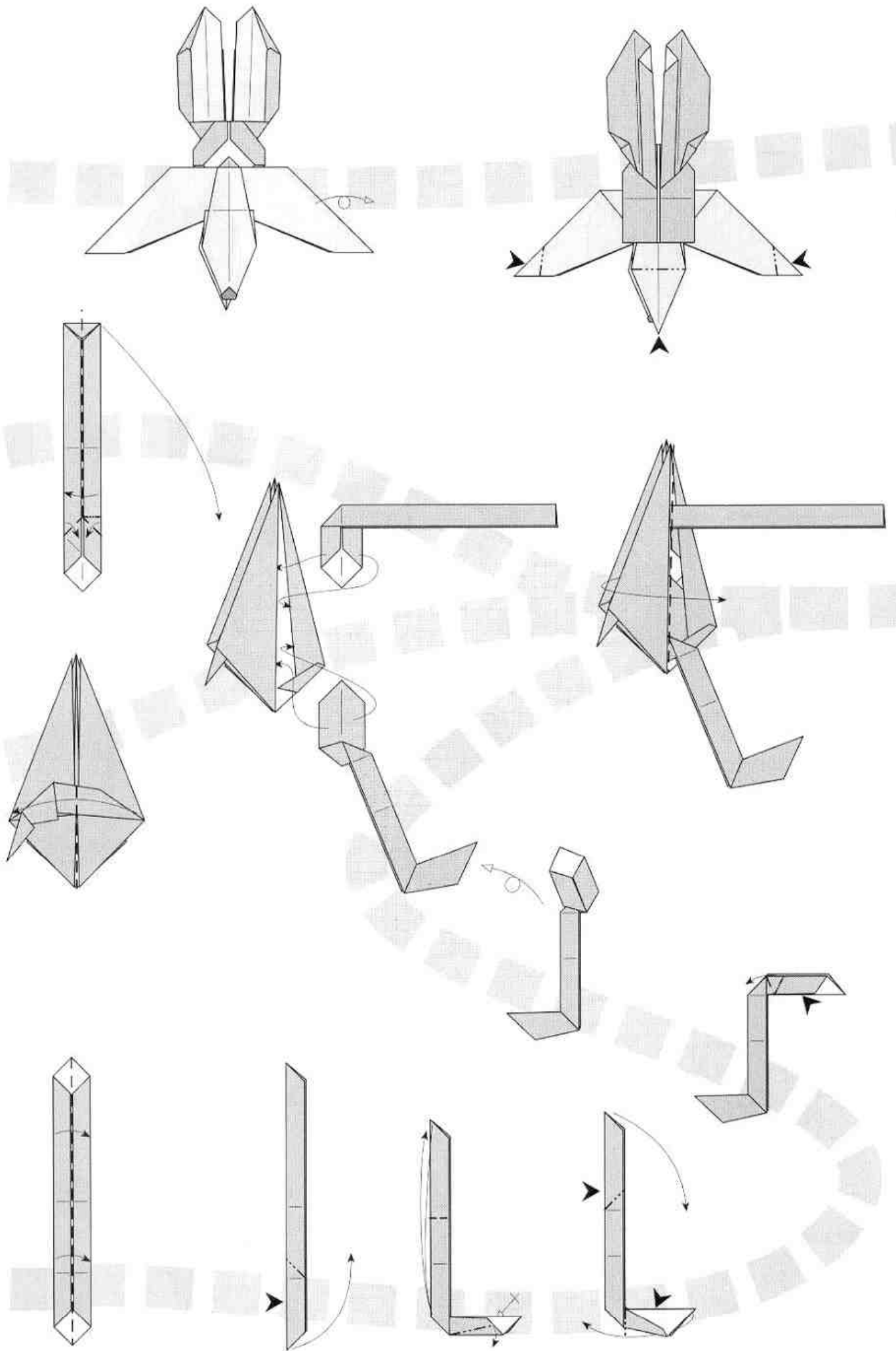

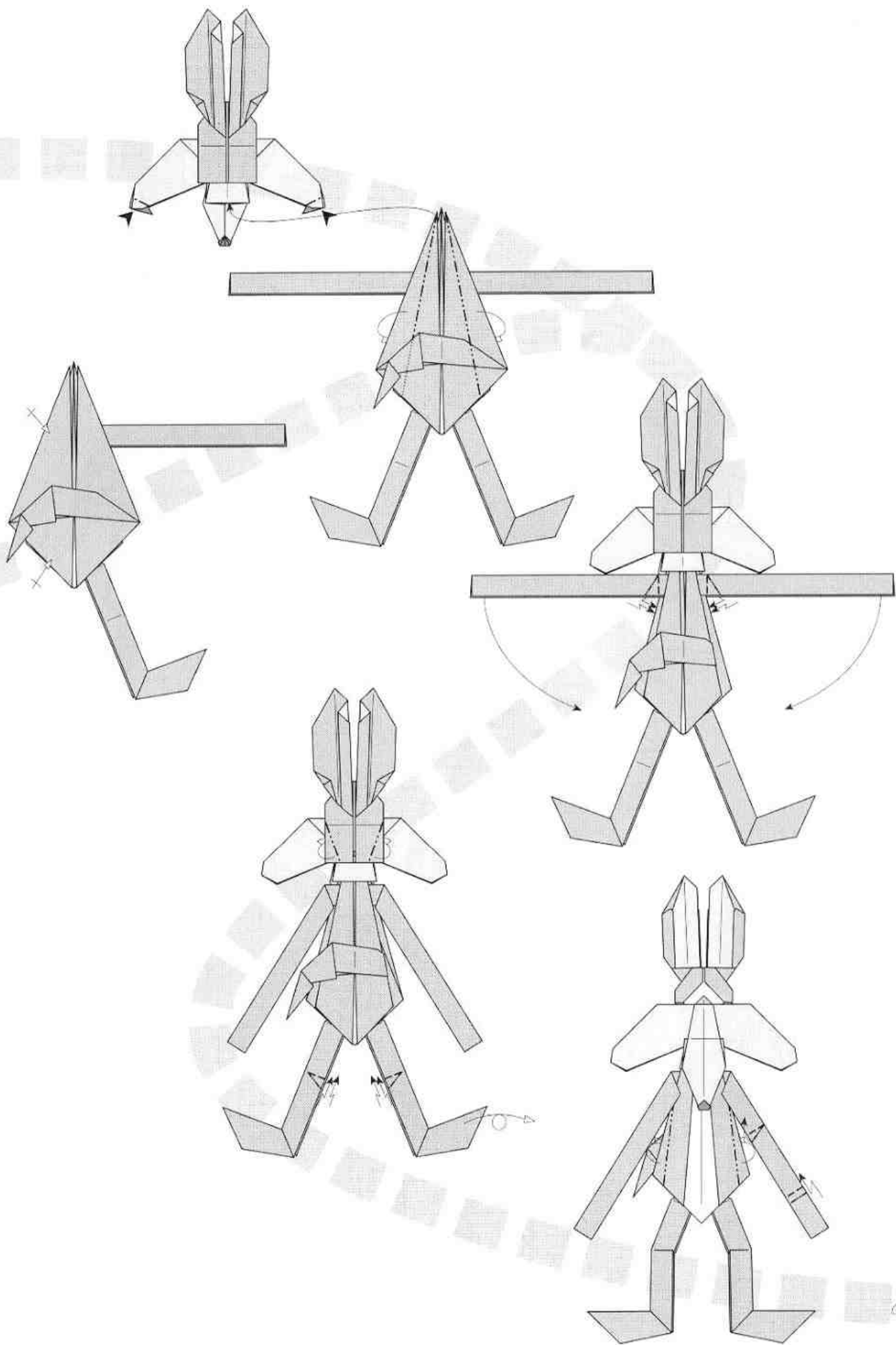

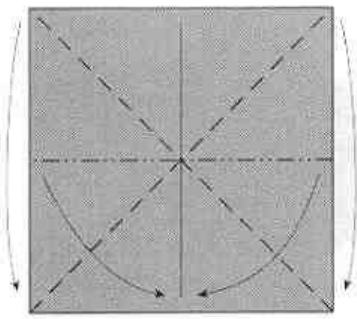

● Negro
○ Blanco

■ 5 cm
5 cm

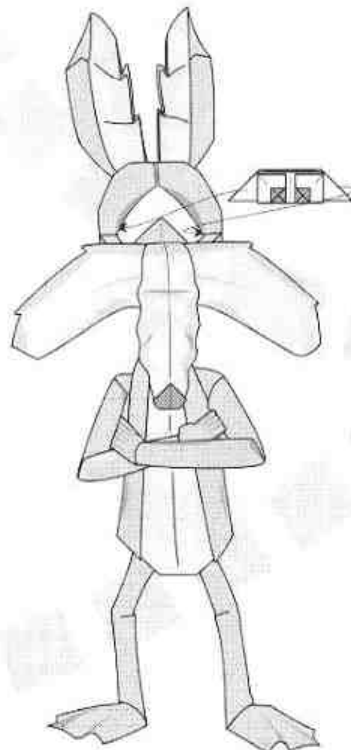
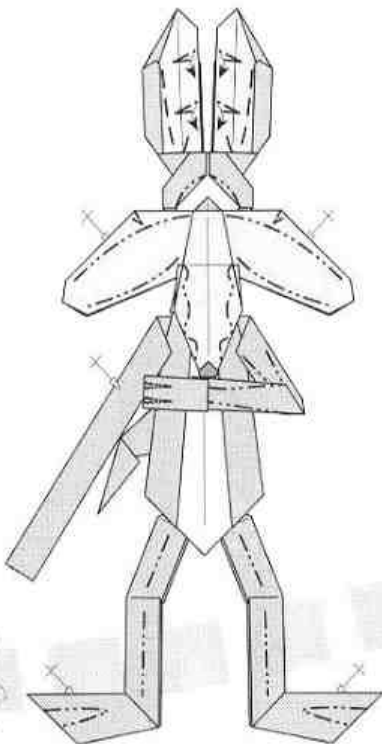
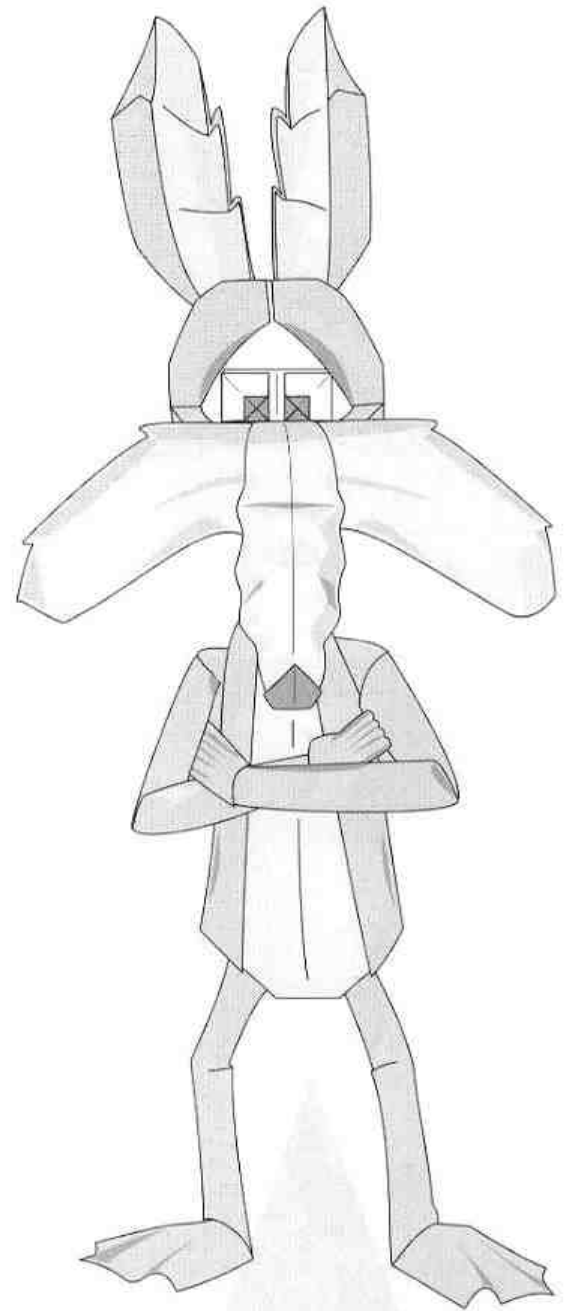
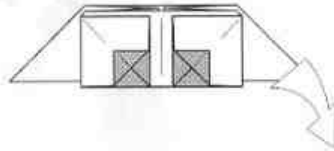
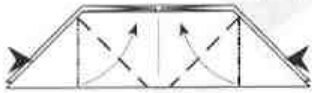
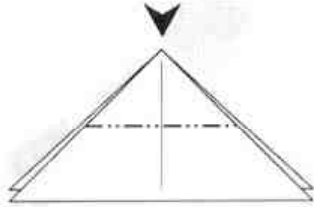
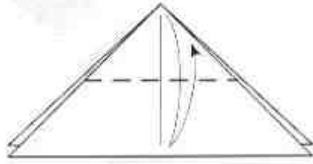

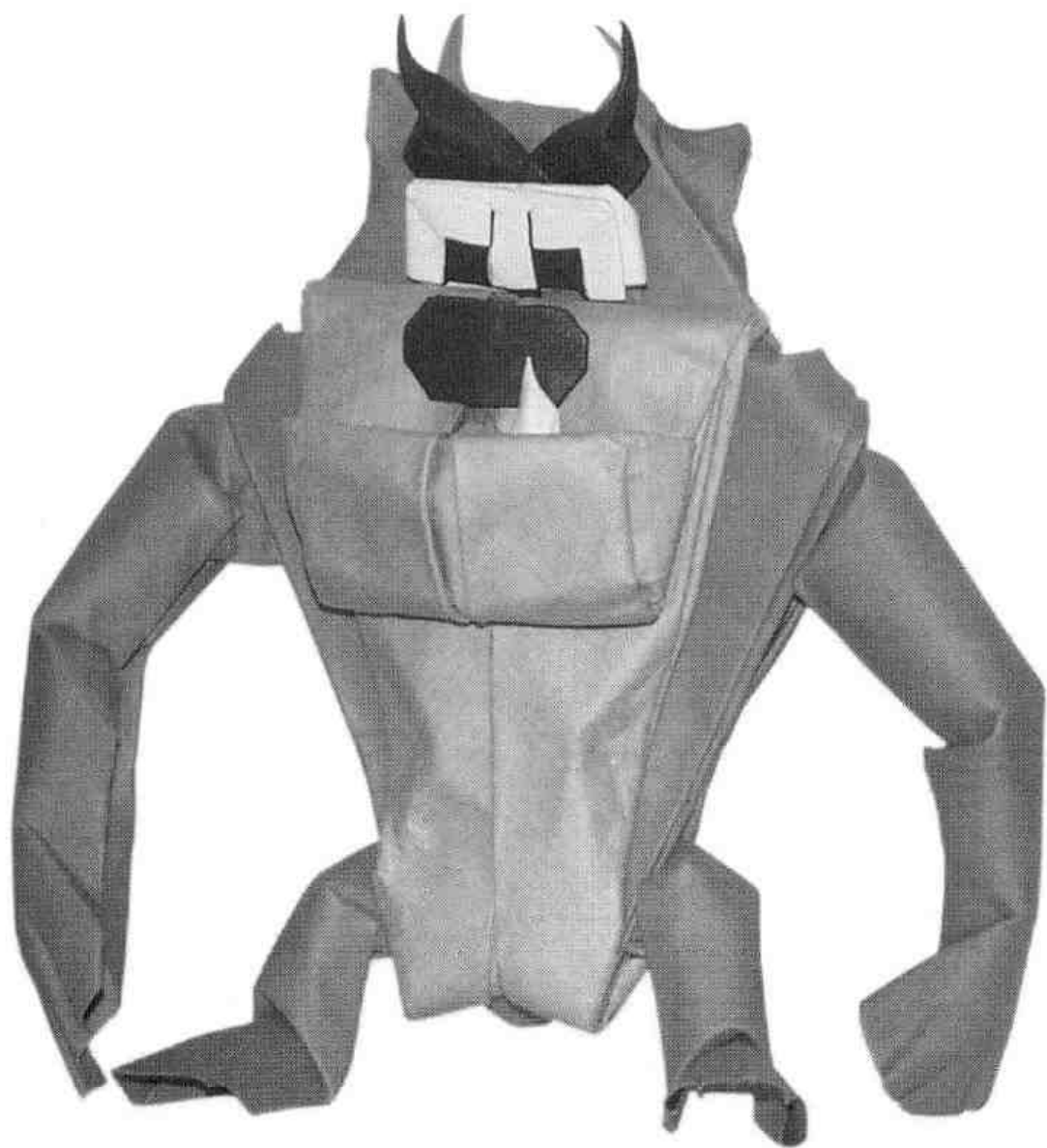

Utilizando las medidas recomendadas, se obtiene un modelo final de 13,5 cms.

Autor:	Halle
Nivel de dificultad:	Medio
Número de piezas:	8
Forma de las piezas:	Cuadrados

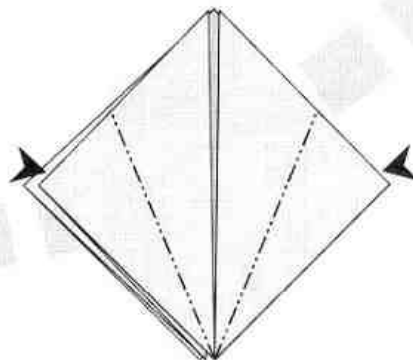
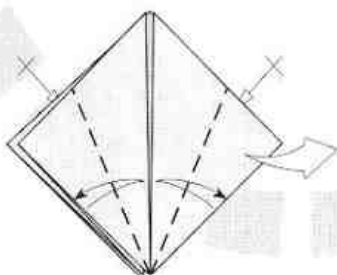
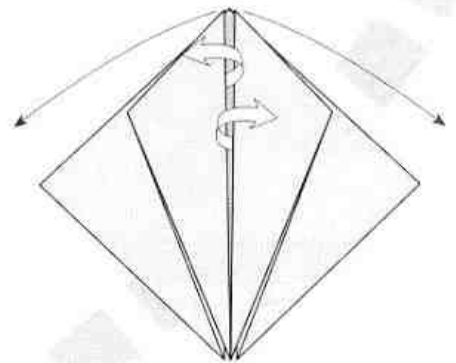
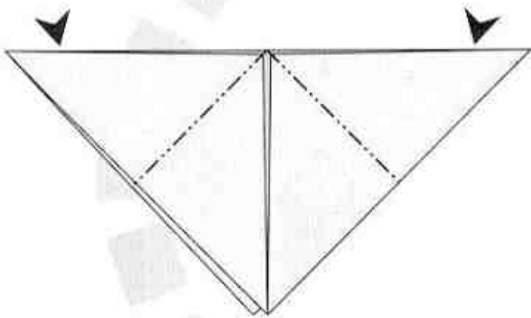
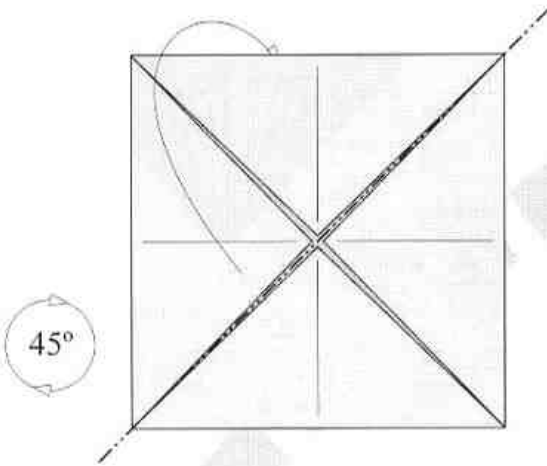
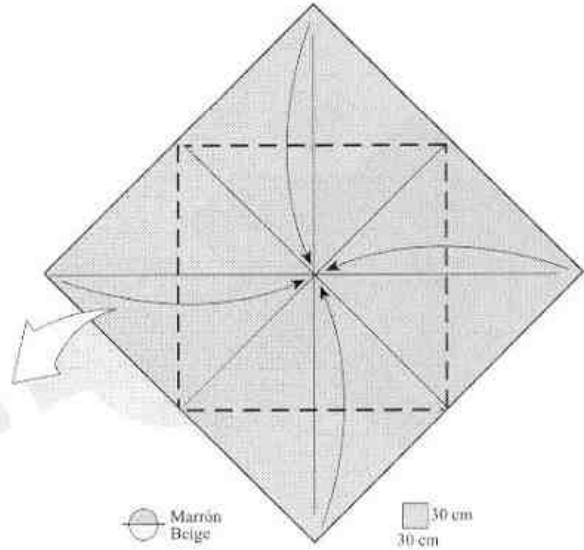
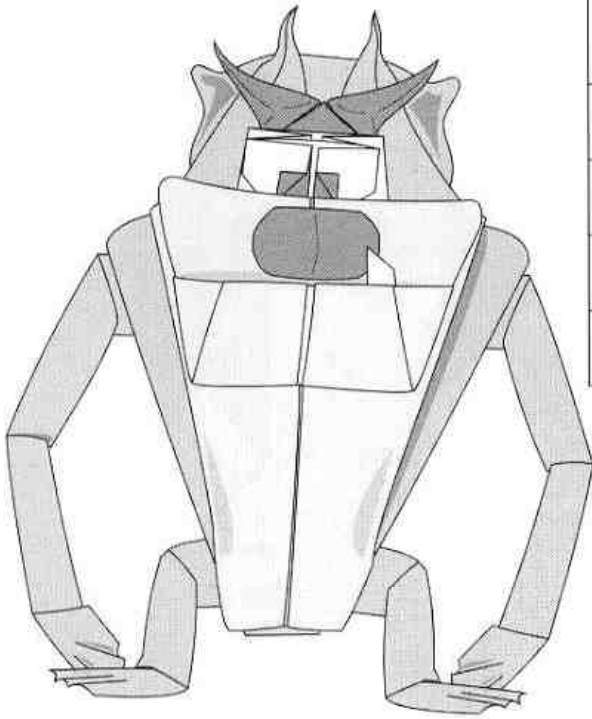

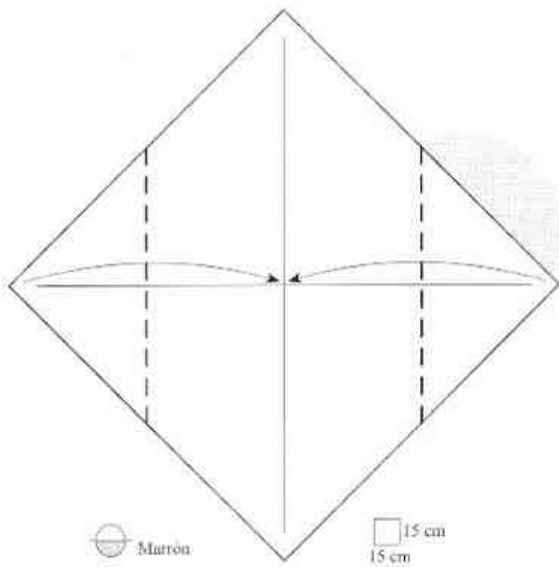

Marrón

15 cm
15 cm

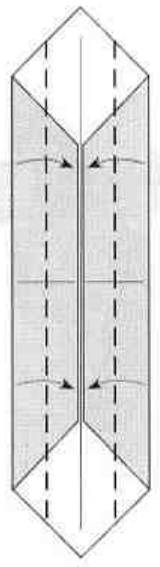
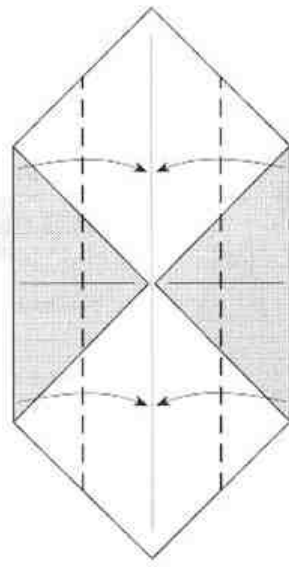

90°

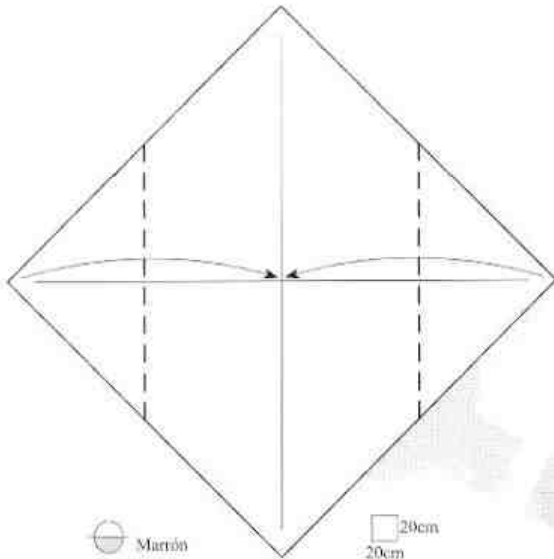
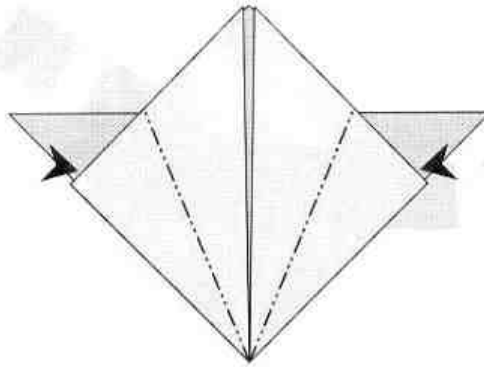
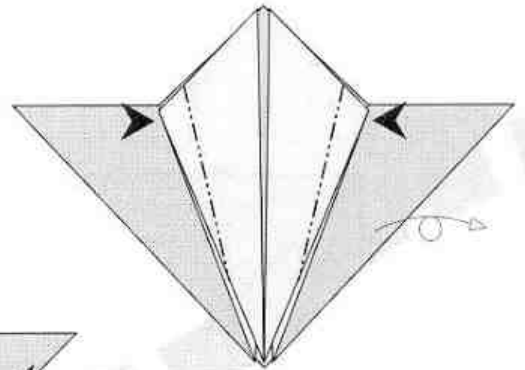
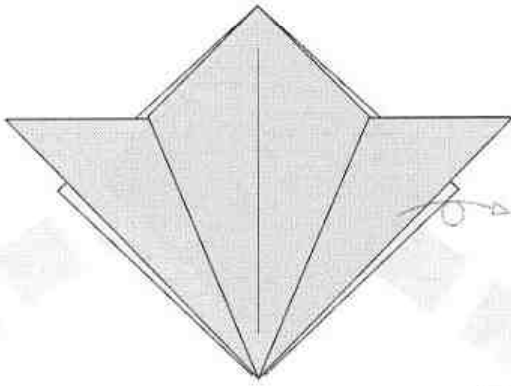

Marrón

20cm
20cm

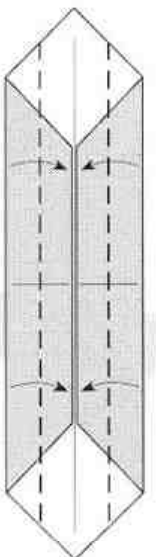
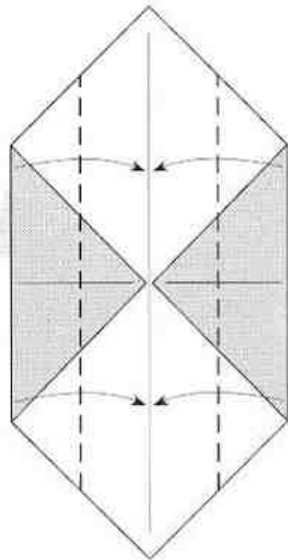

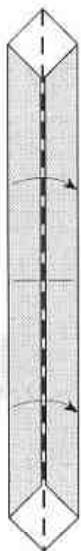
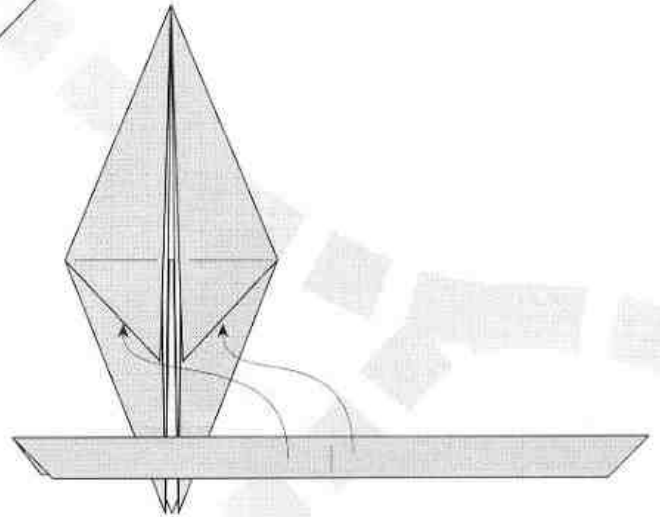
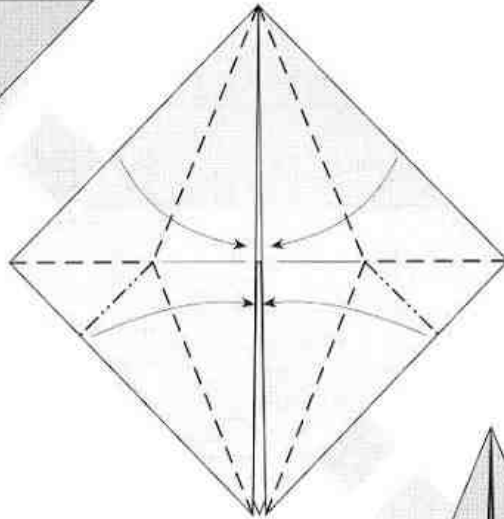
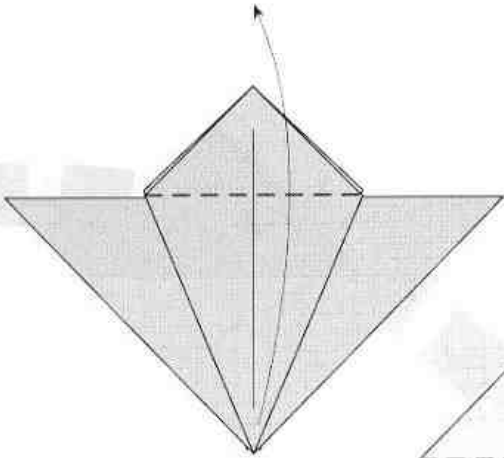
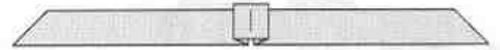
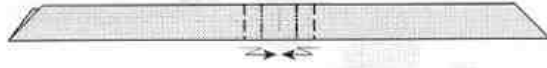

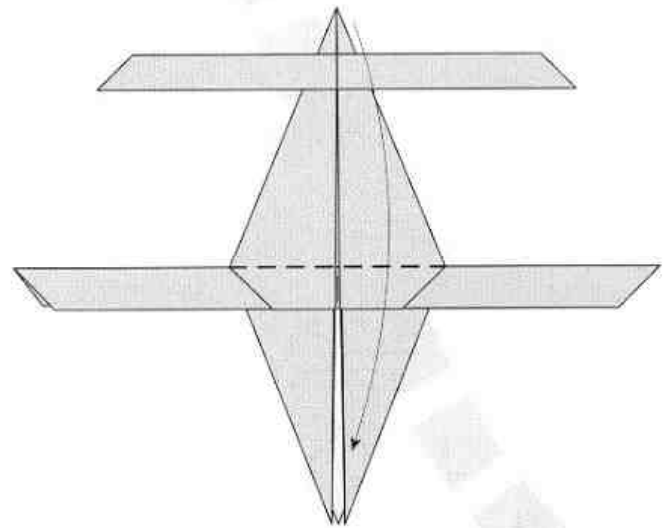
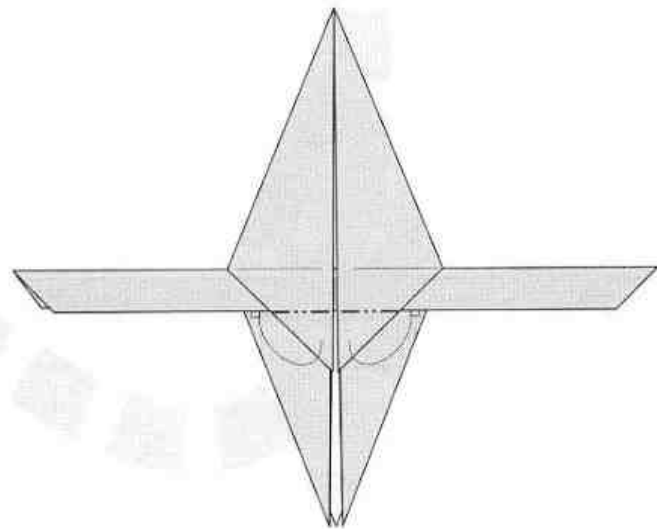
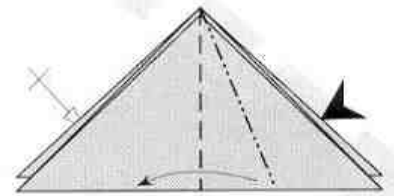
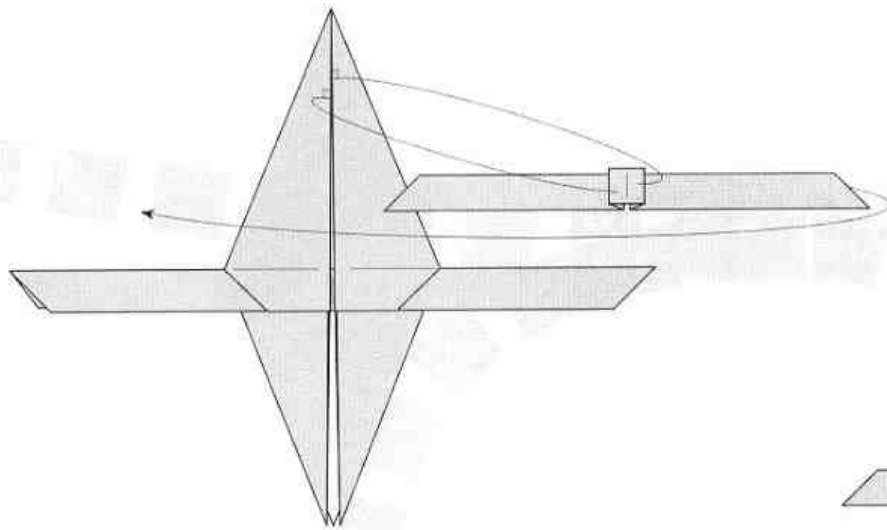
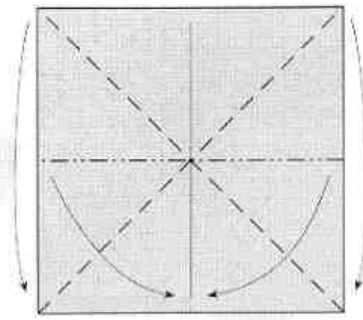
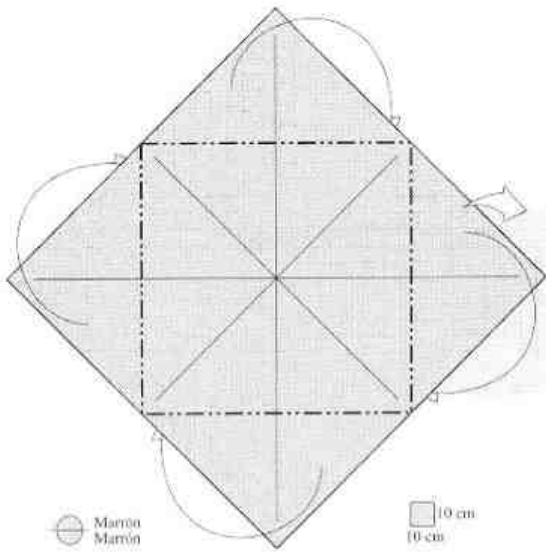

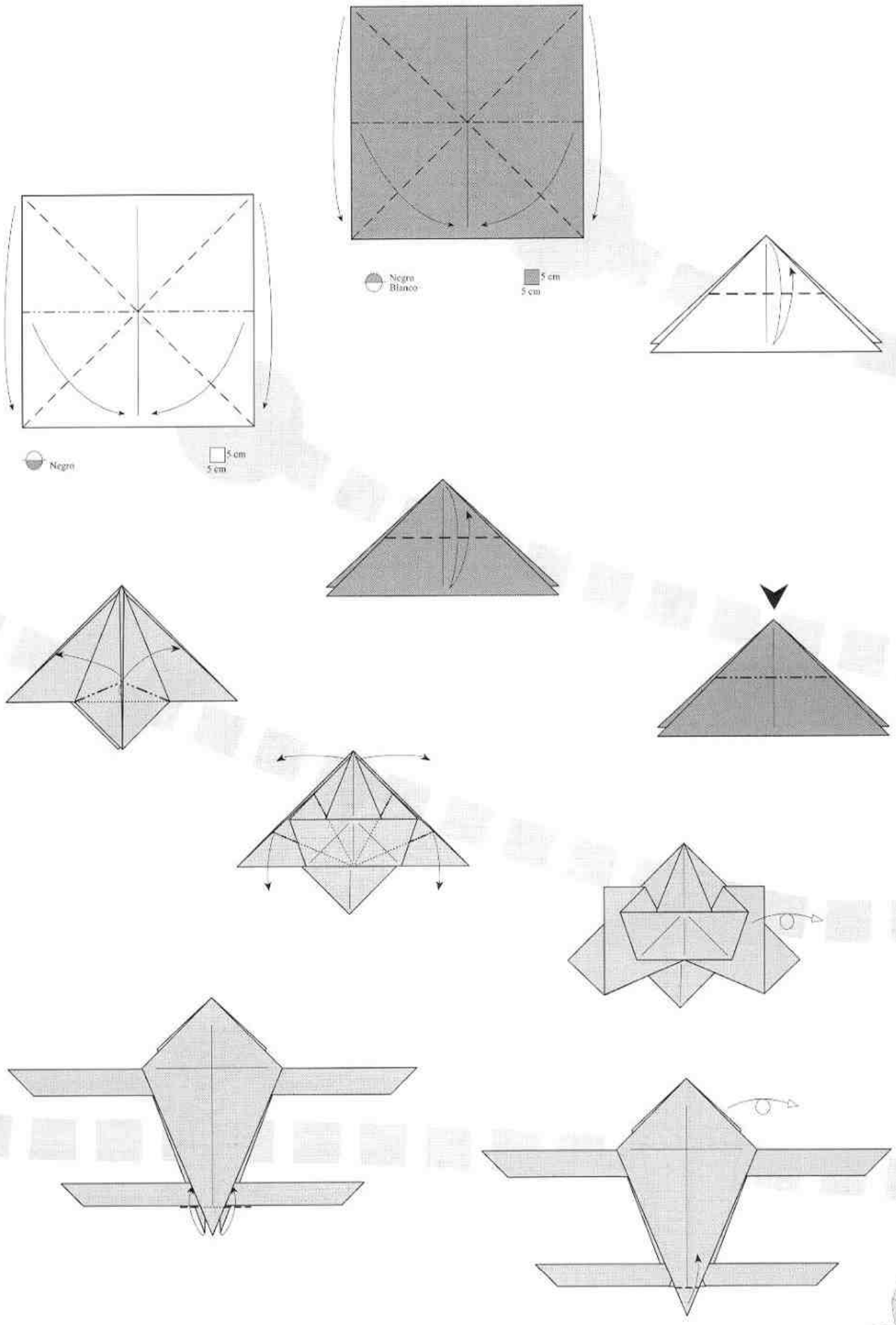

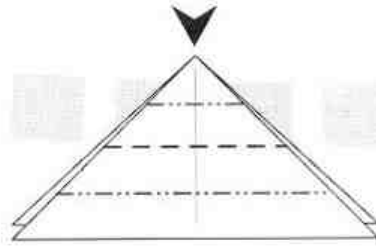
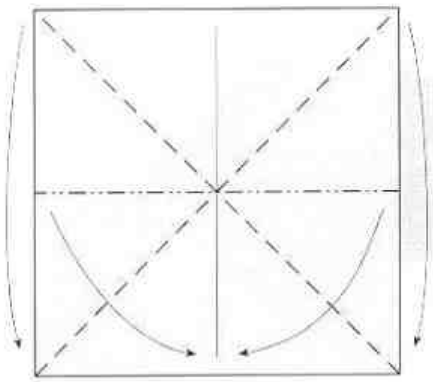

⊖ Blanco

5 cm
5 cm

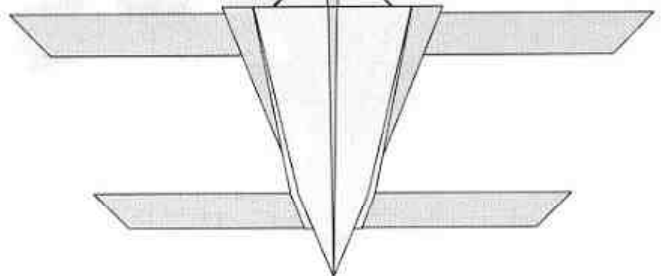
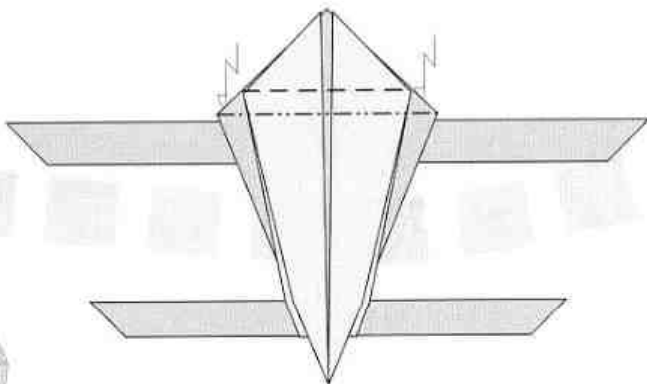
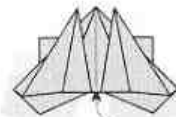
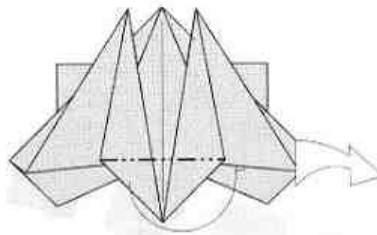
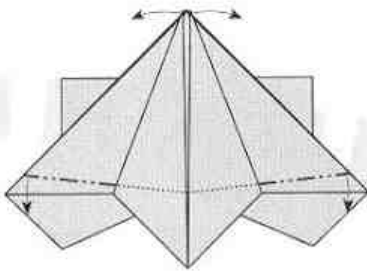
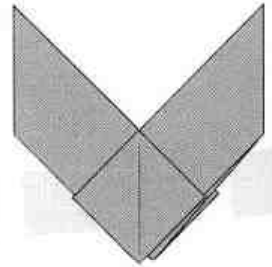
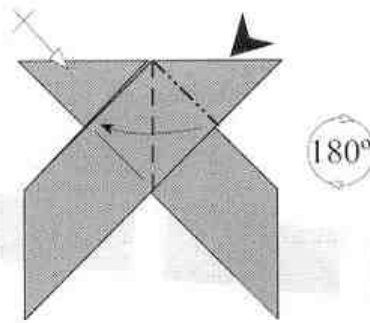
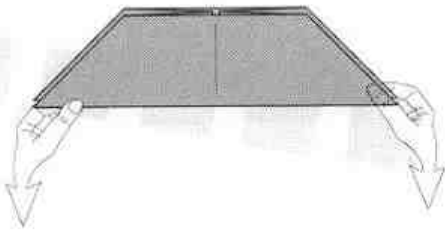
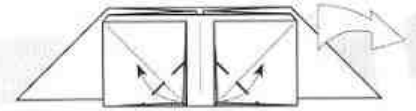
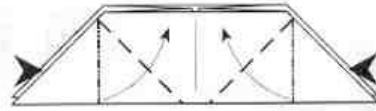
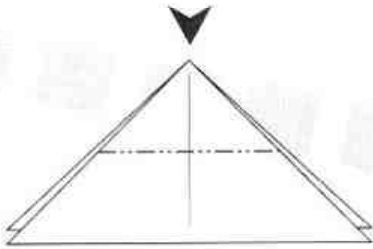

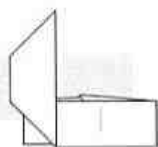
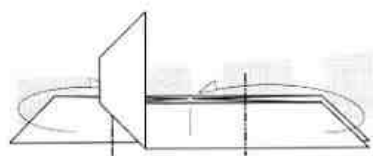

180°

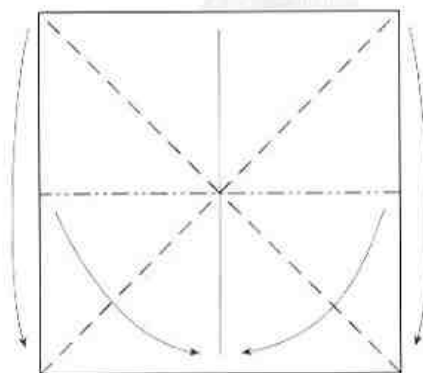
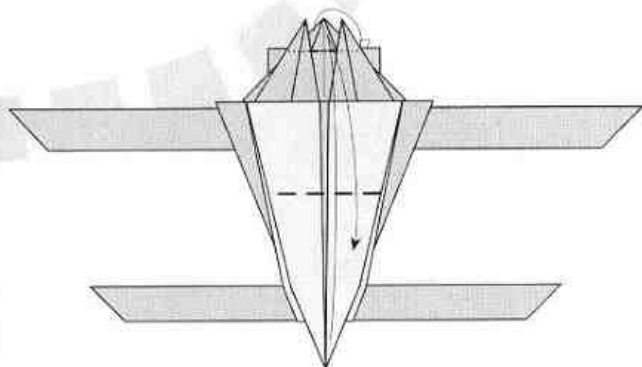
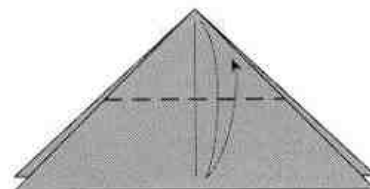
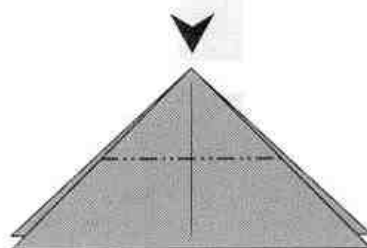
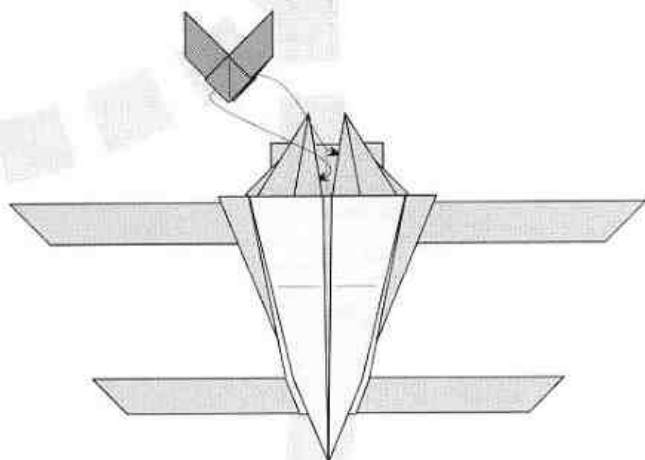
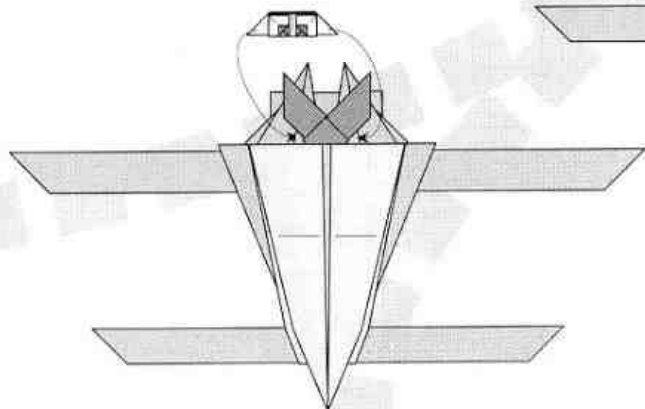
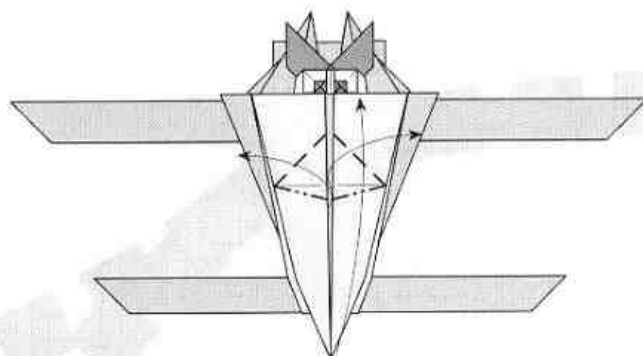
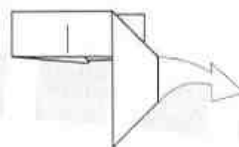

Negri

5 cm
5 cm



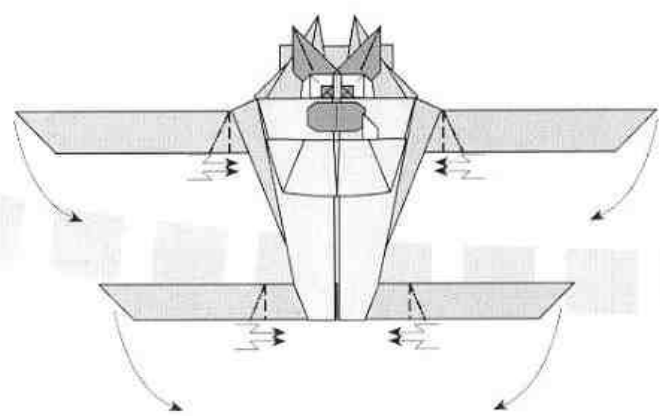
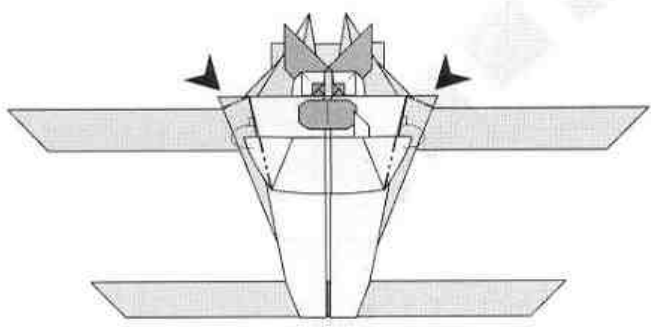
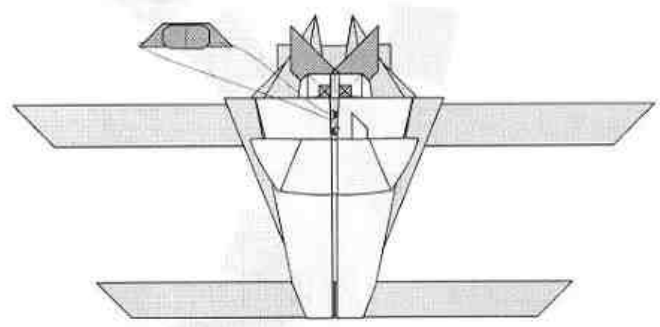
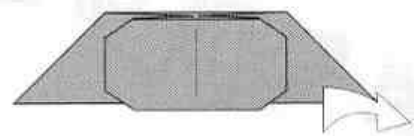
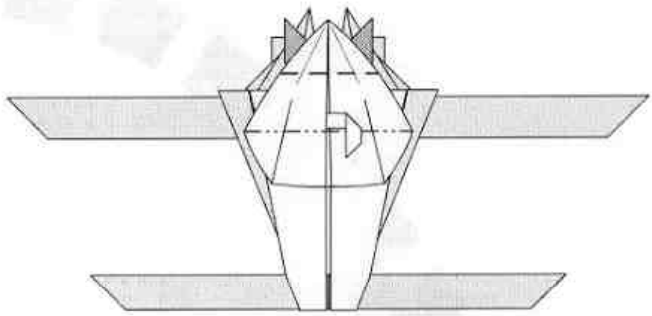
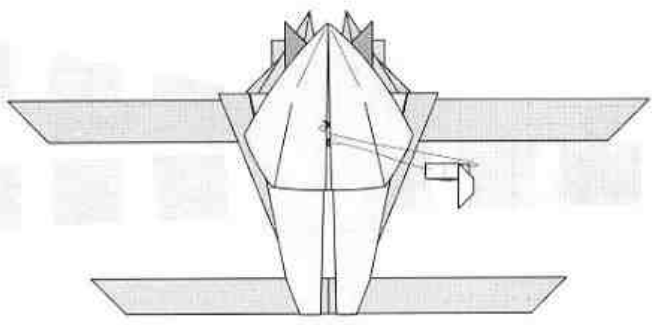

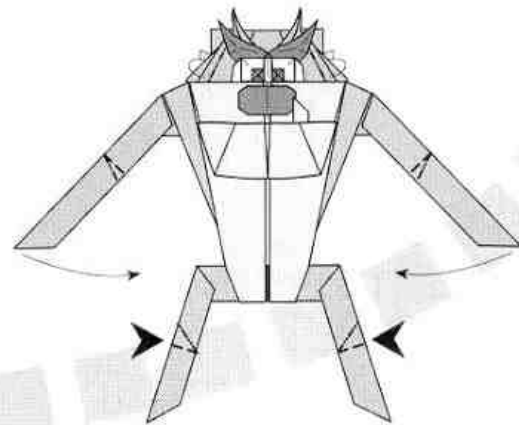
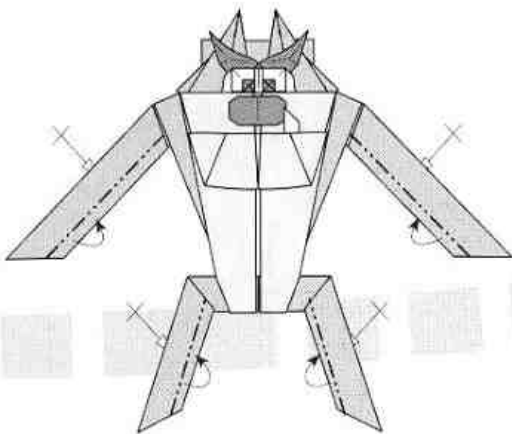
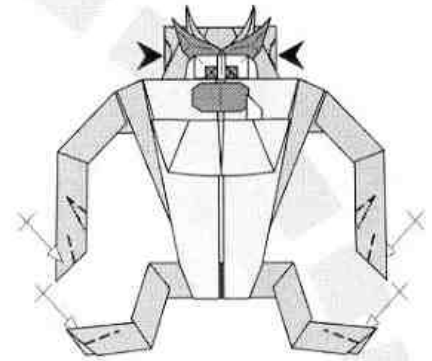
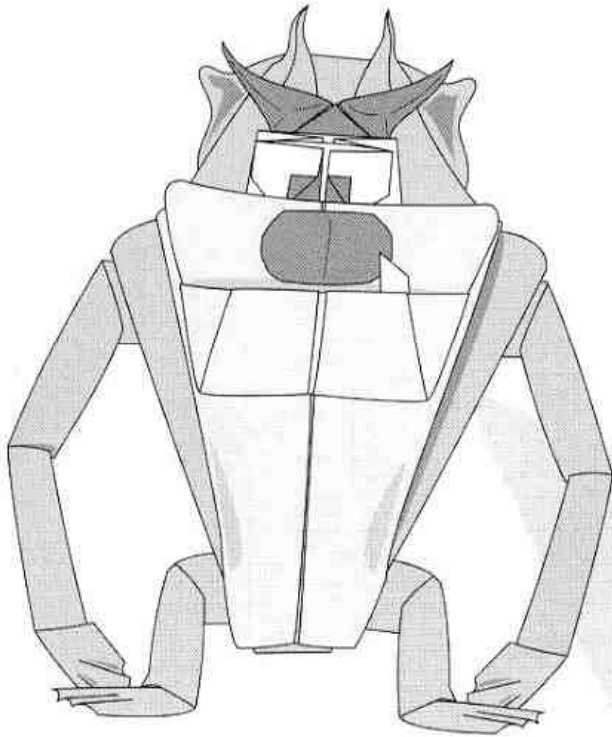

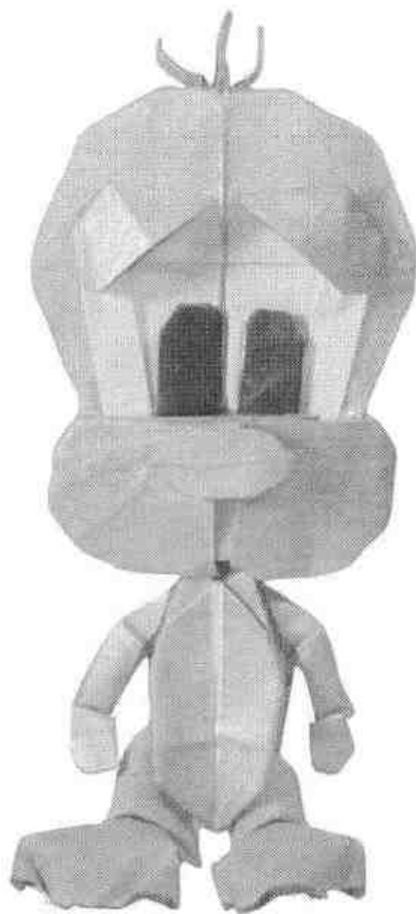

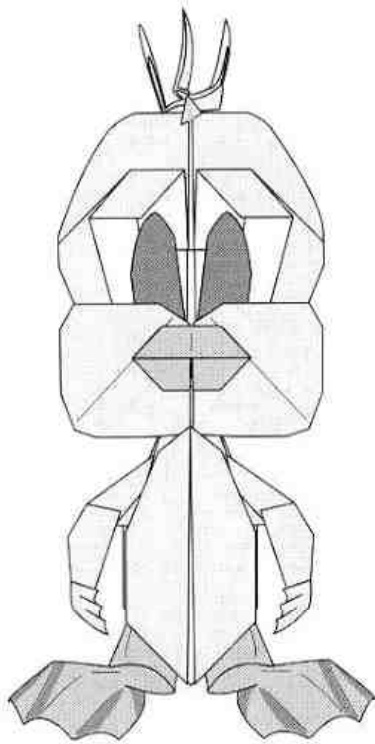

Utilizando las medidas recomendadas, se obtiene un modelo final de 17 cms.

Autor:	Halle
Nivel de dificultad:	Medio
Número de piezas:	8
Forma de las piezas:	Cuadrados

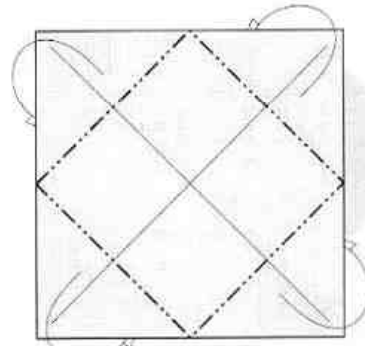

○ Amarillo

□ 15 cm
15 cm

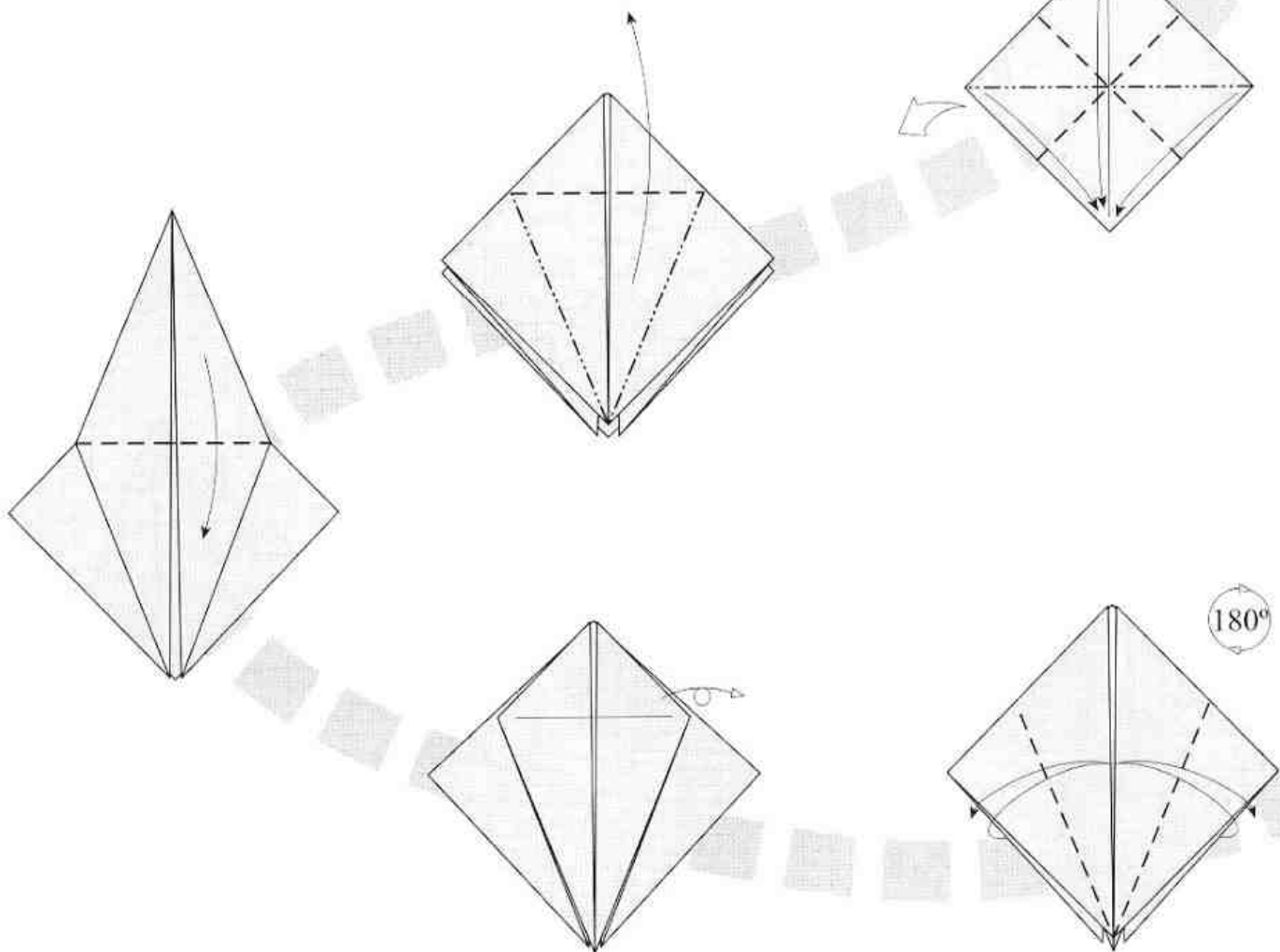

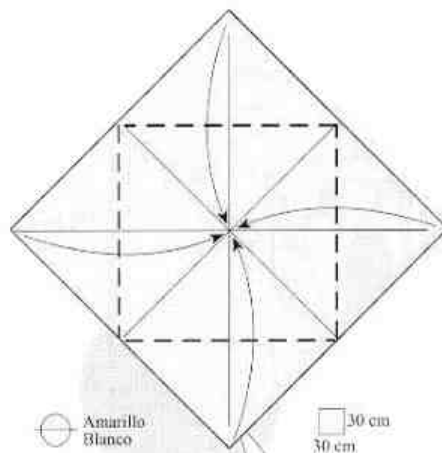
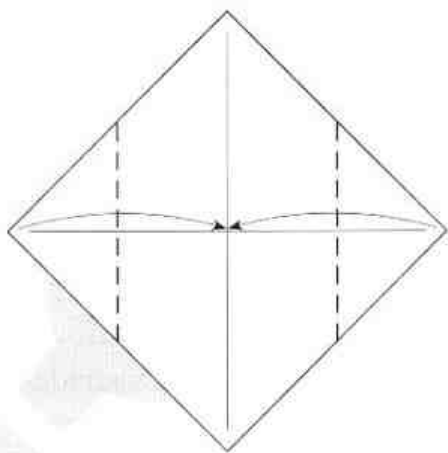

Naranja

7,5 cm
7,5 cm

Amarillo
Blanco

30 cm
30 cm

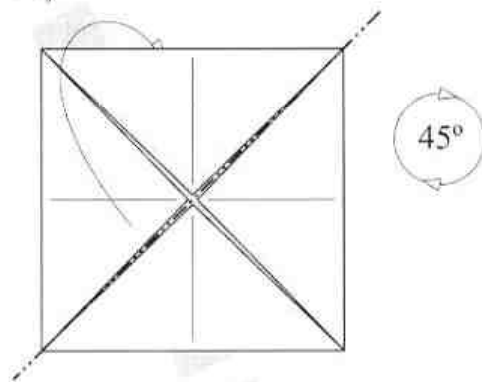
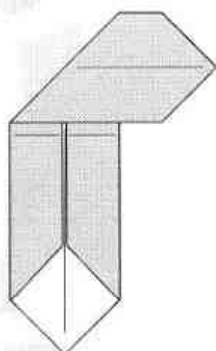
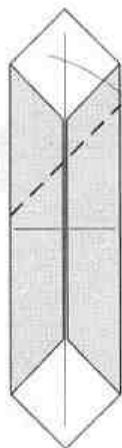
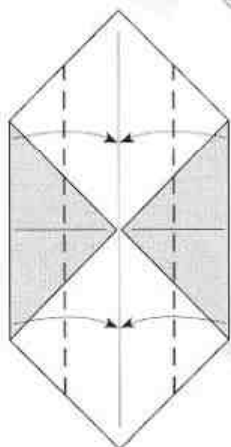

45°

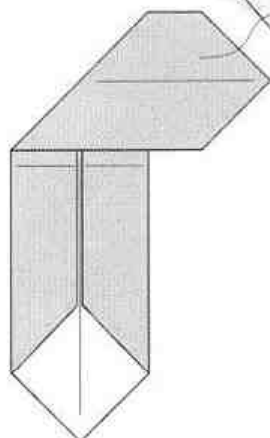
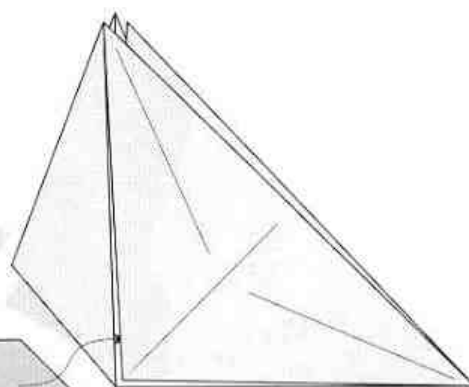
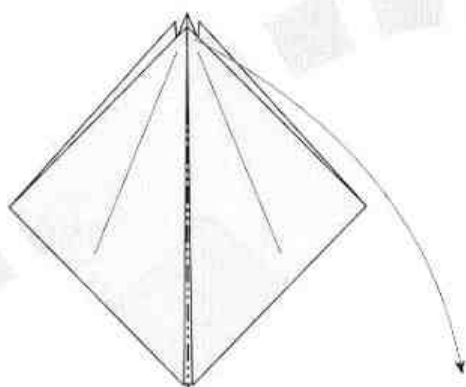
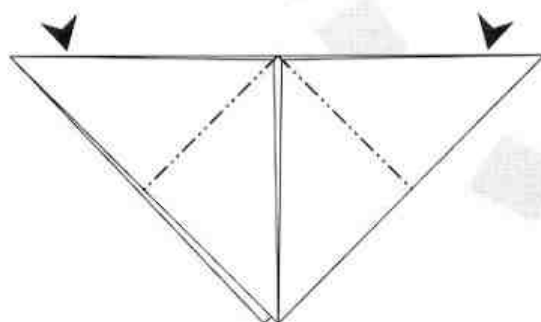

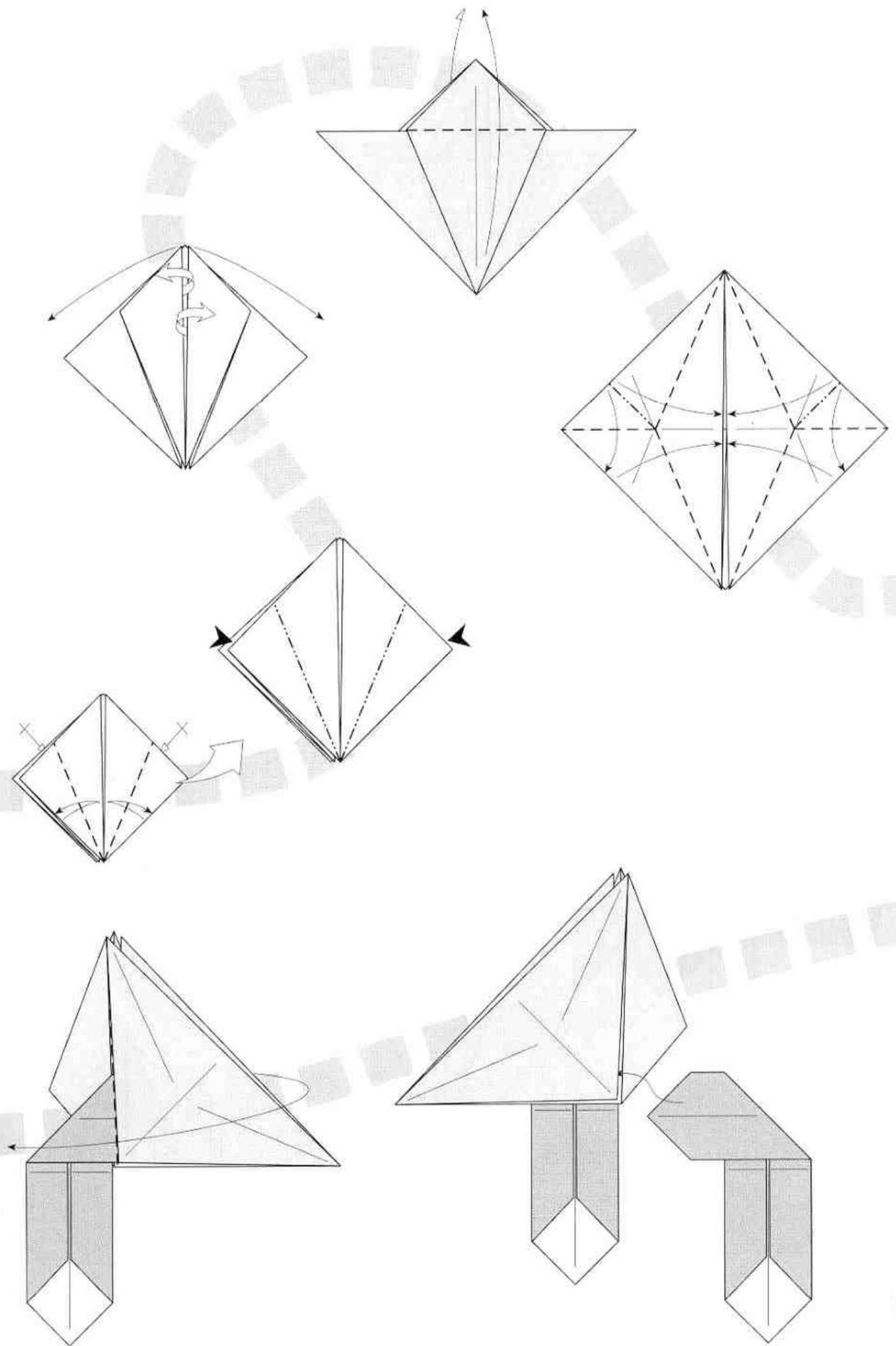

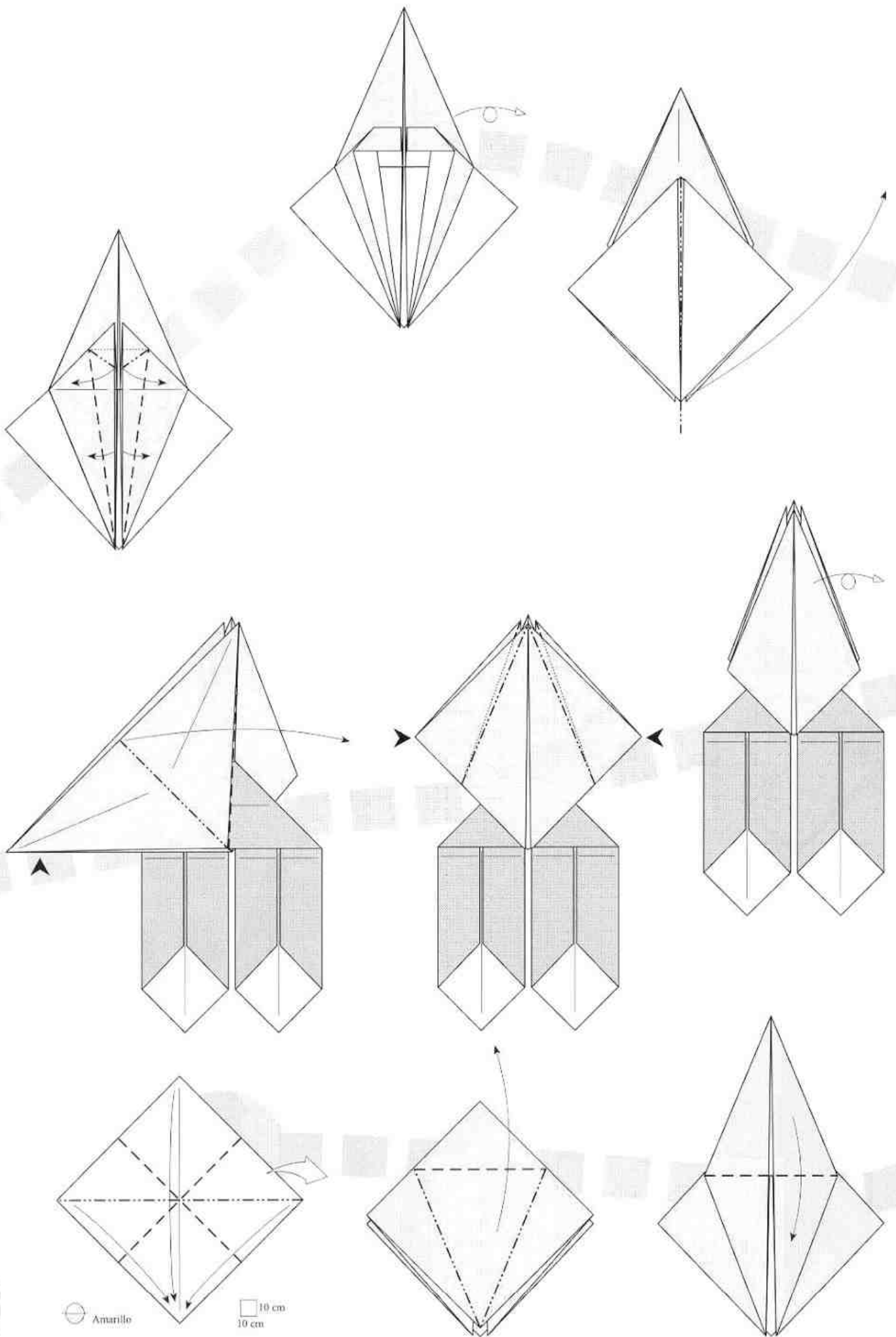

⊖ Amarillo

□ 10 cm
10 cm

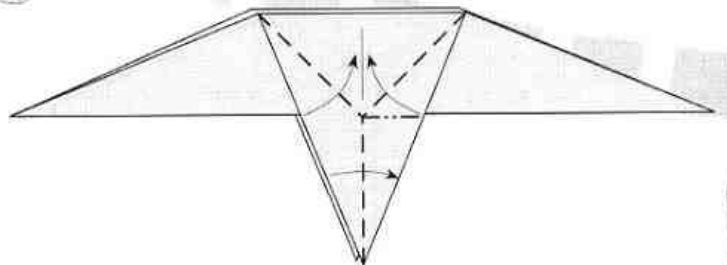
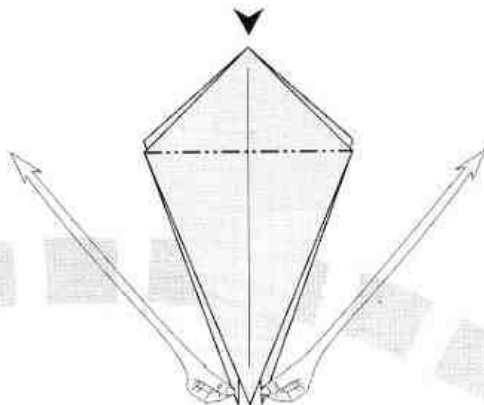
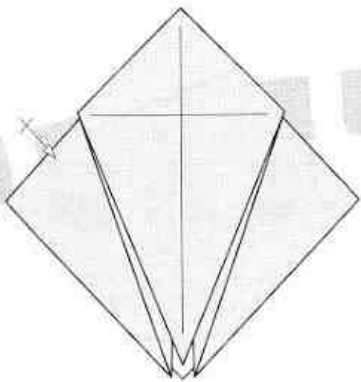
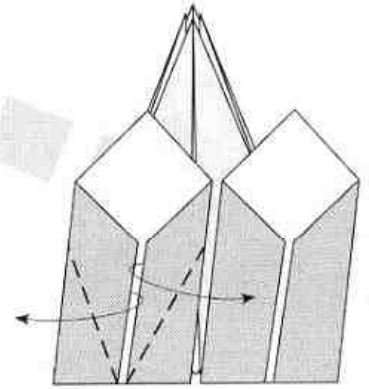
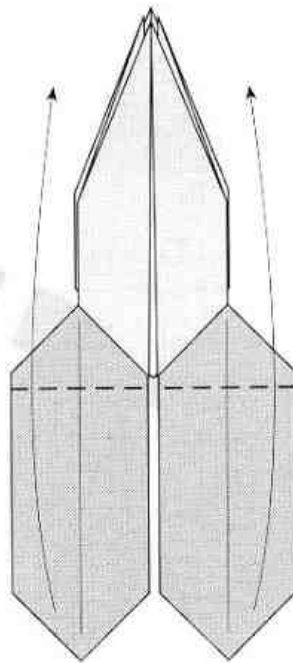
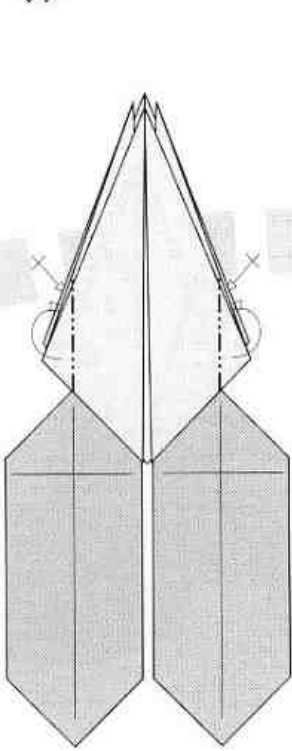
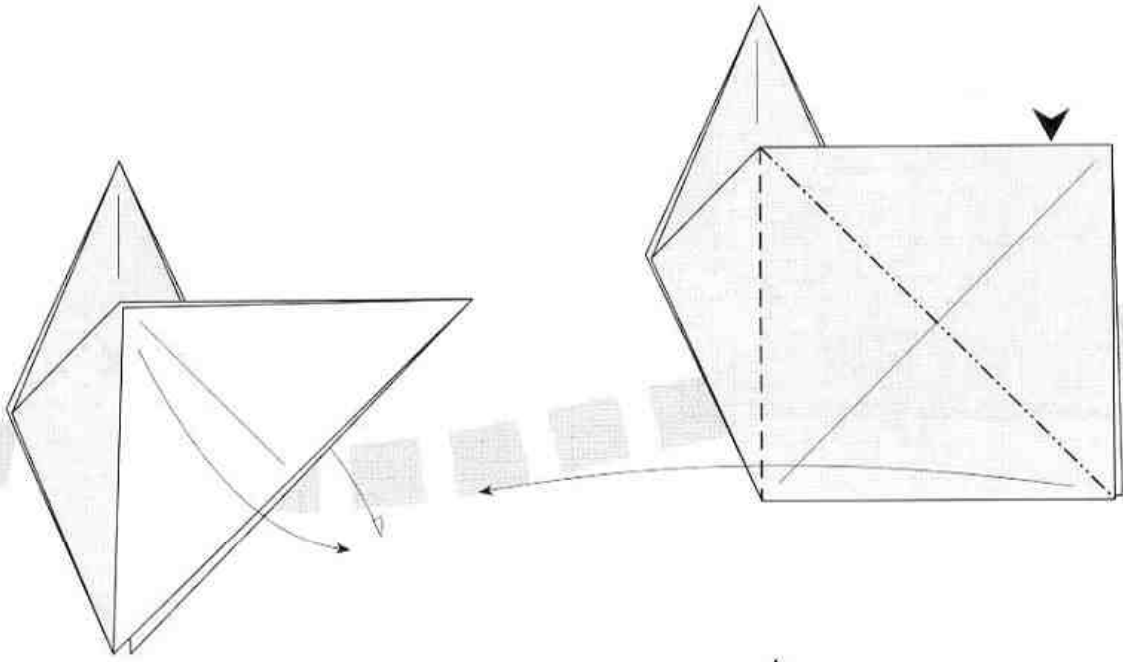

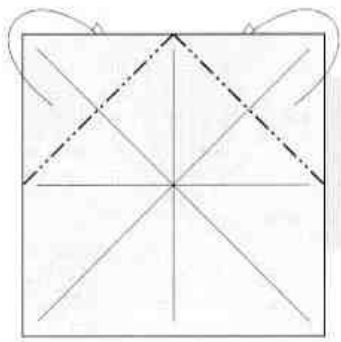
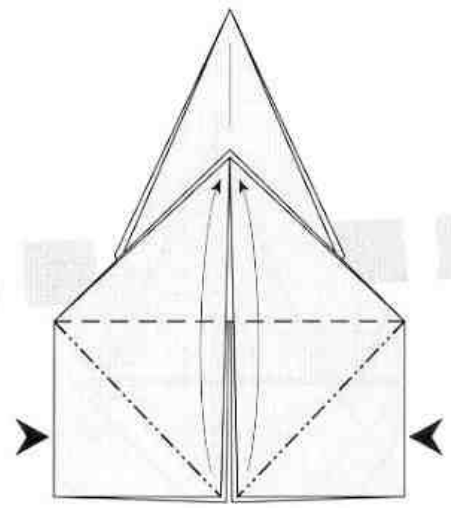
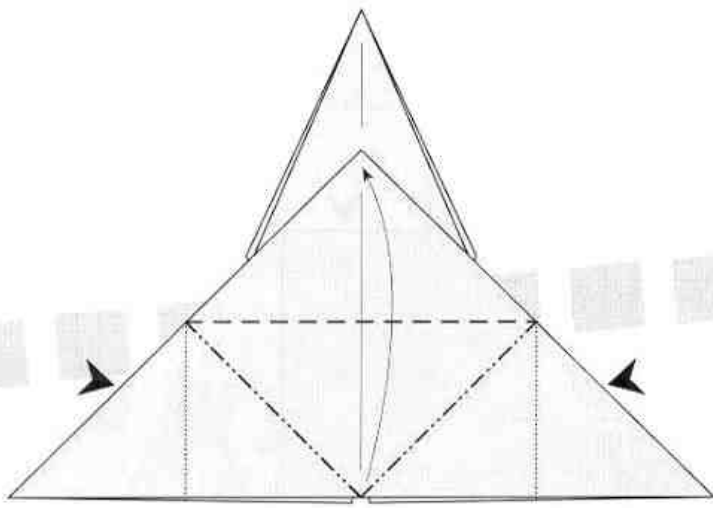

● Amarillo
● Azul

□ 15 cm
□ 15 cm

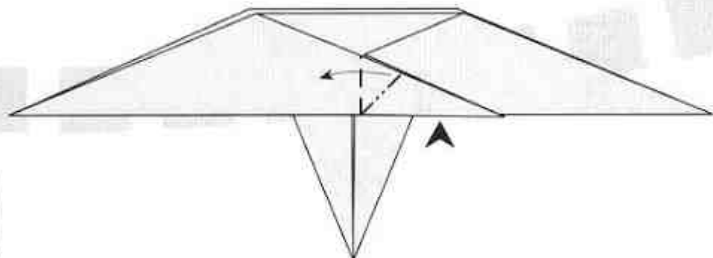
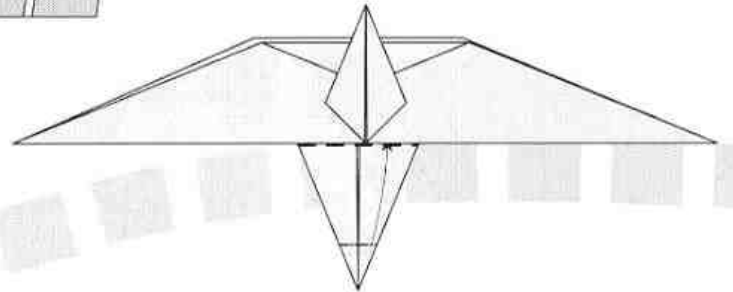
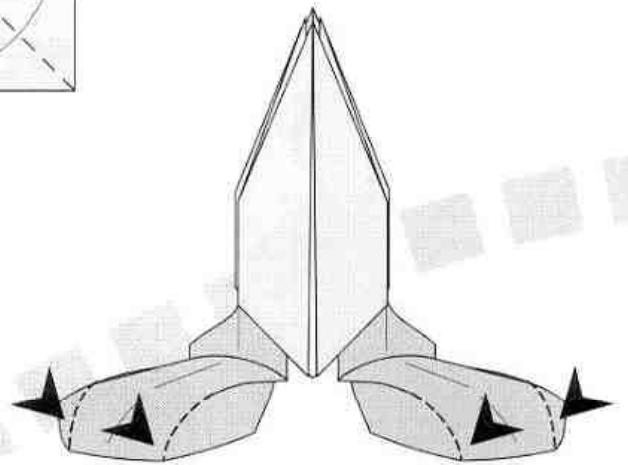
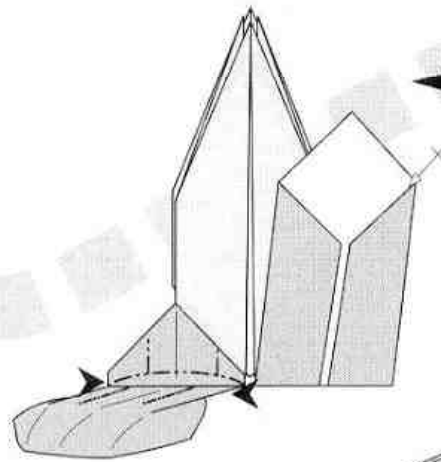
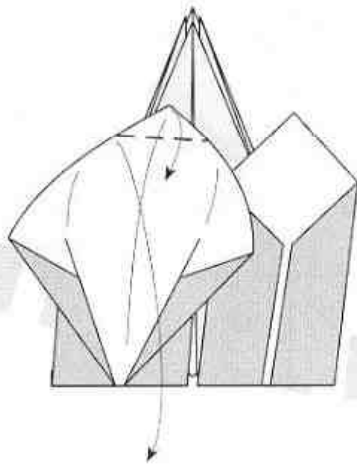
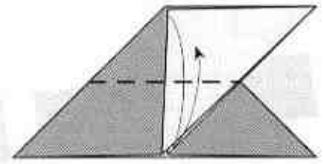
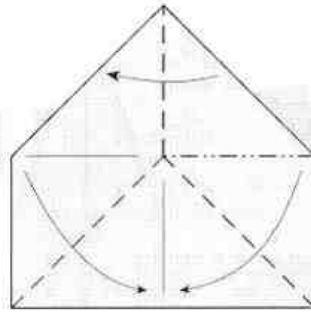

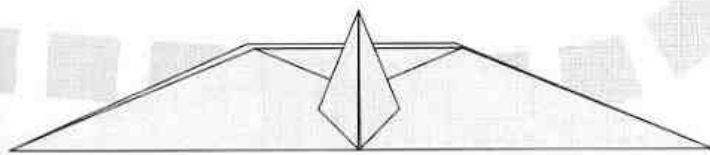
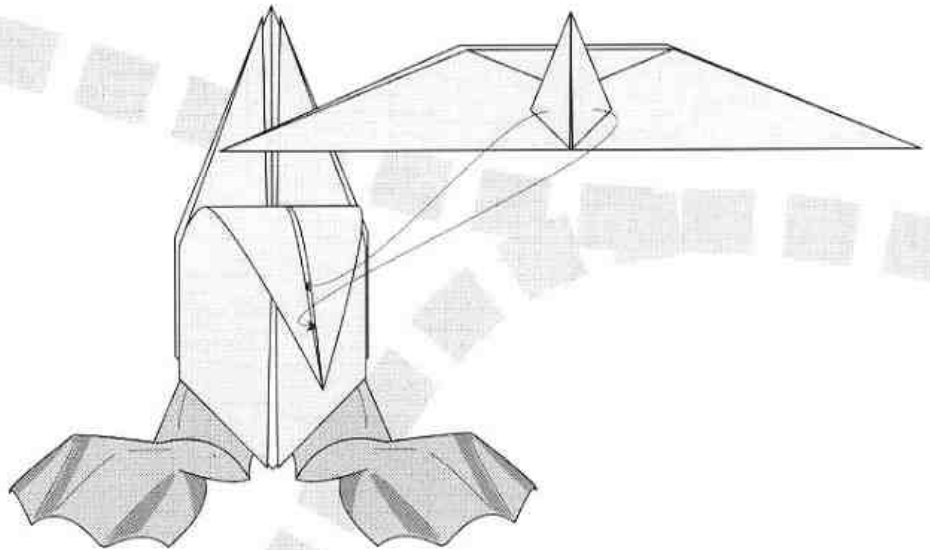
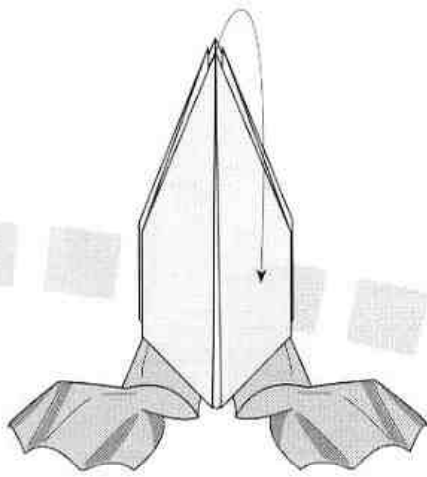
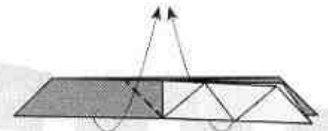
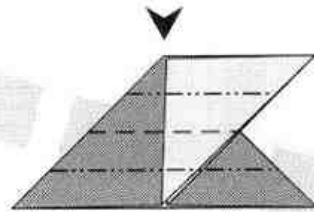
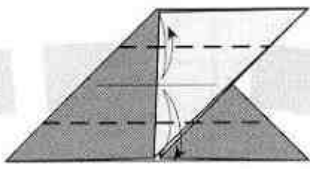
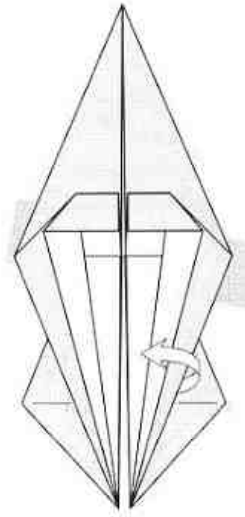
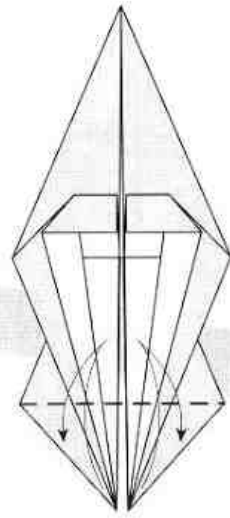
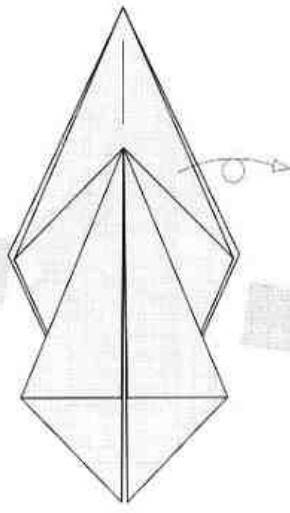
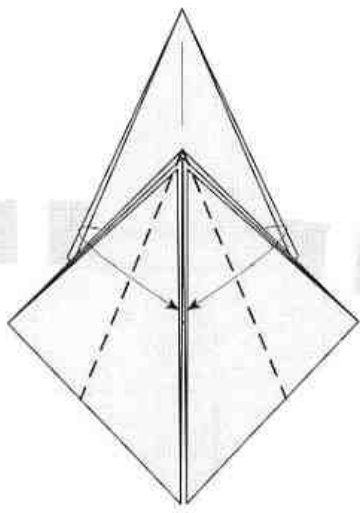

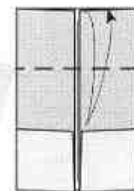
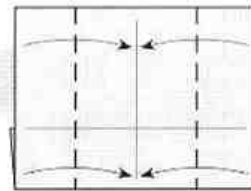
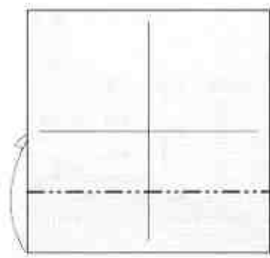
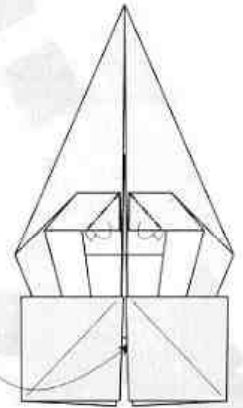
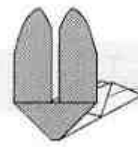
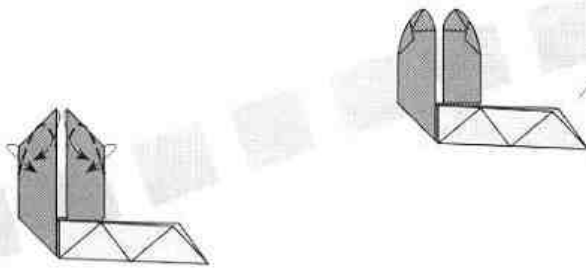
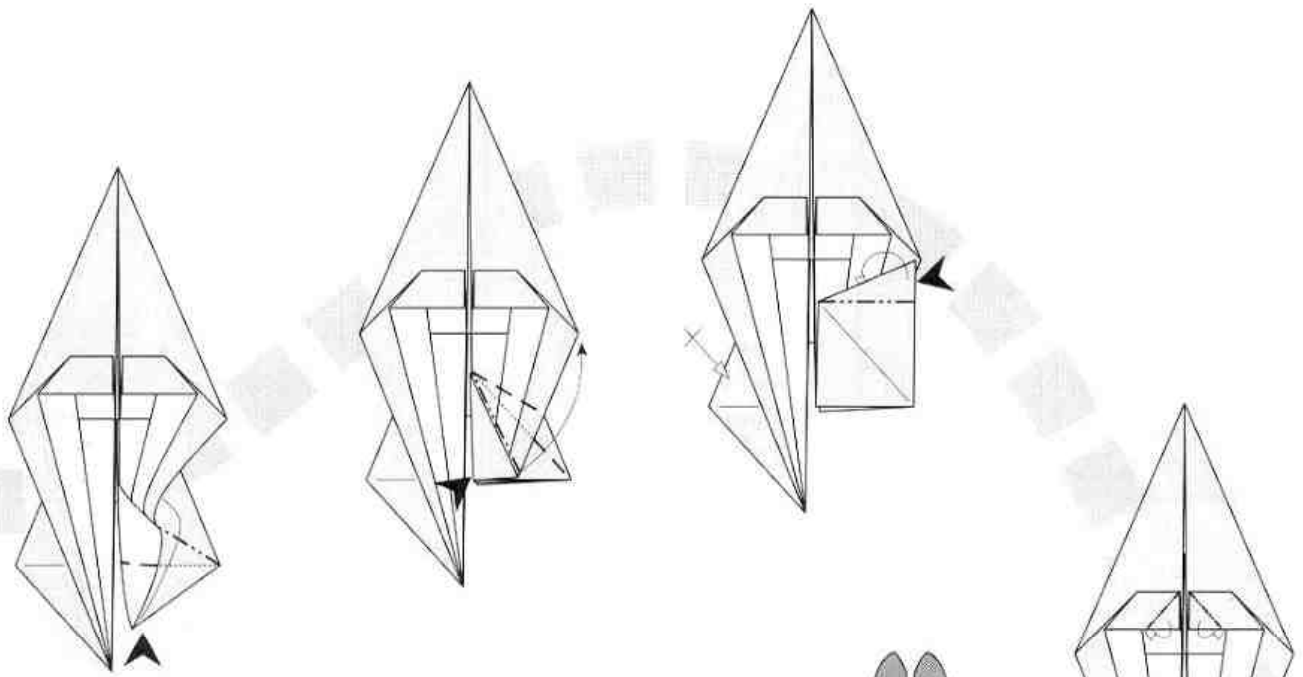

● Amarillo
○ Naranja

□ 10 cm
□ 10 cm

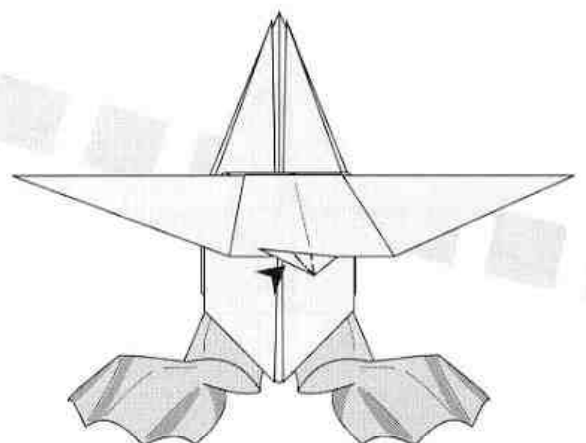
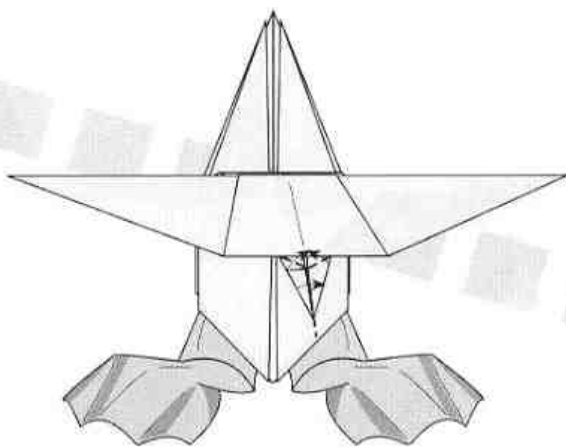

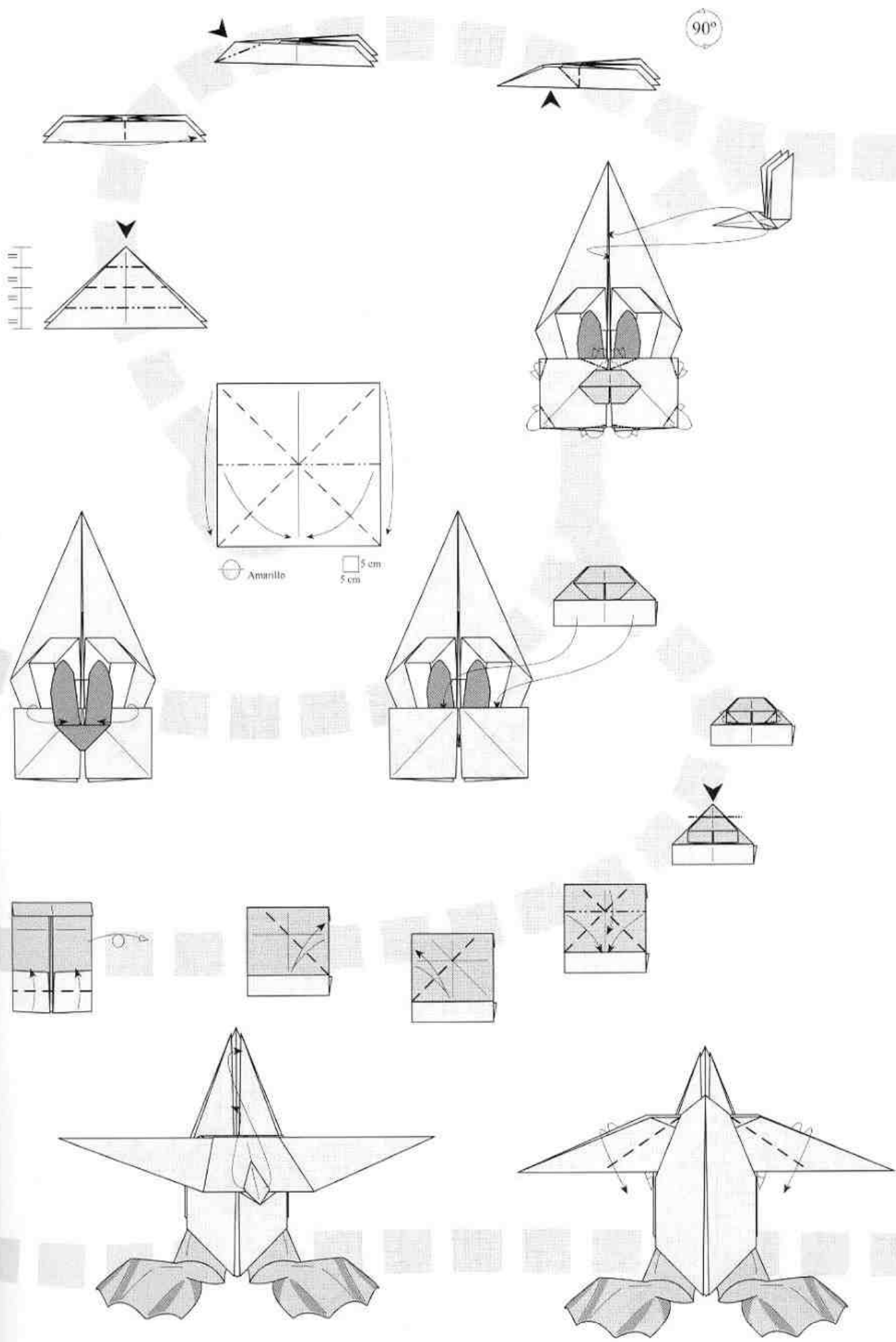

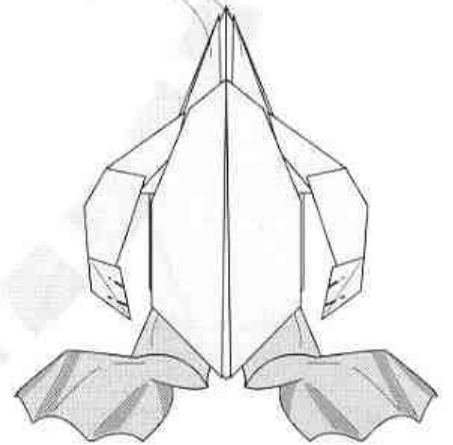
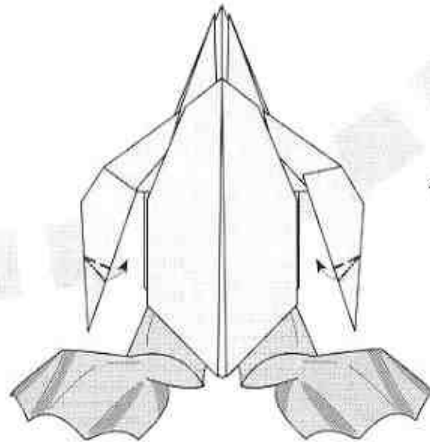
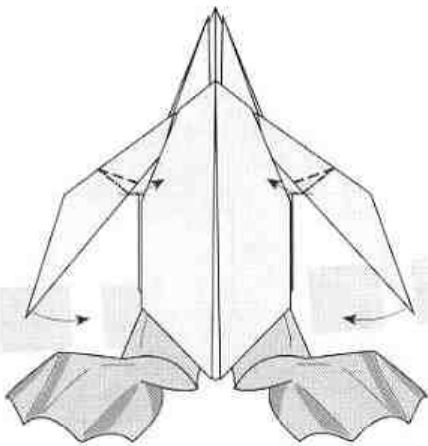
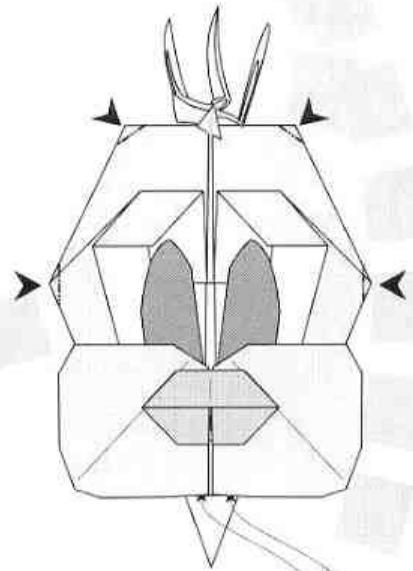
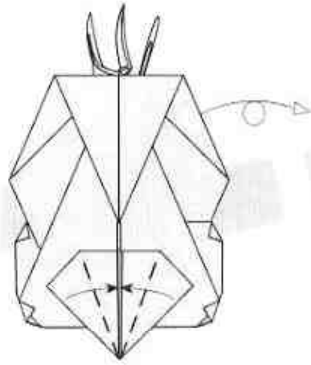
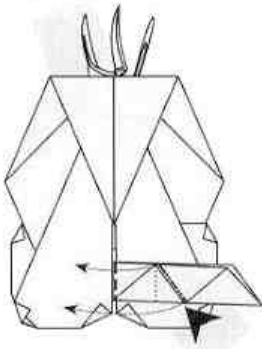
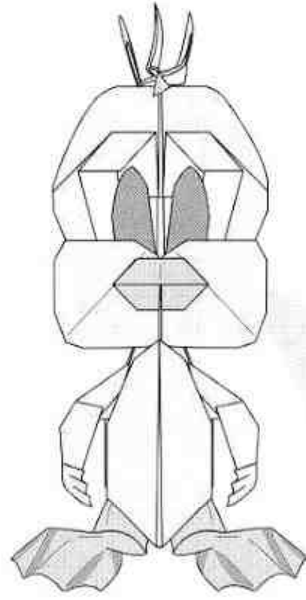
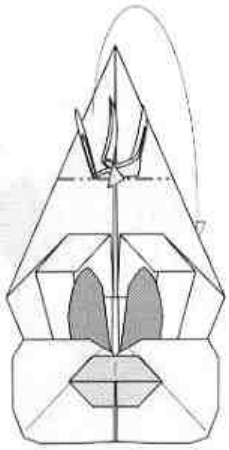

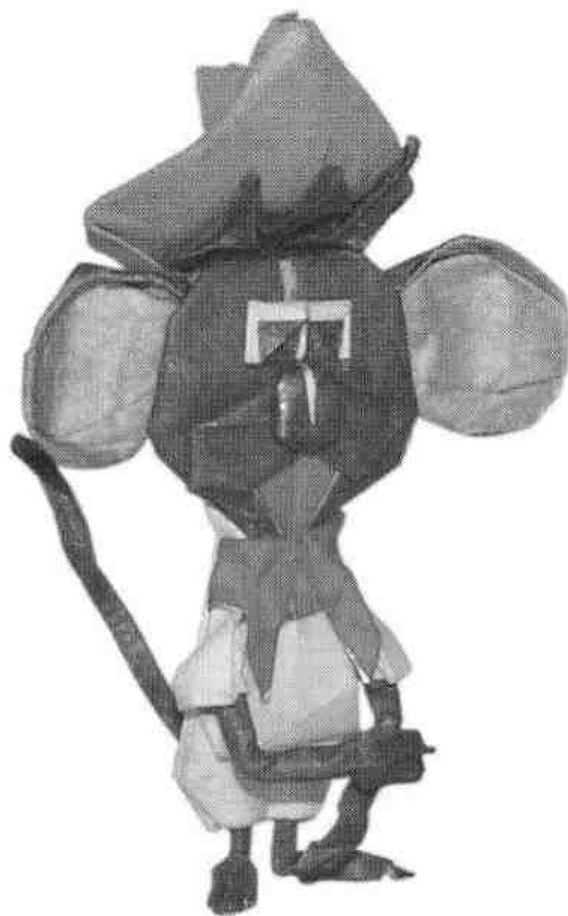



Utilizando las medidas recomendadas, se obtiene un modelo final de 23 cms.

Autor:	Halle
Nivel de dificultad:	Medio-Alto
Número de piezas:	14
Forma de las piezas:	Cuadrados

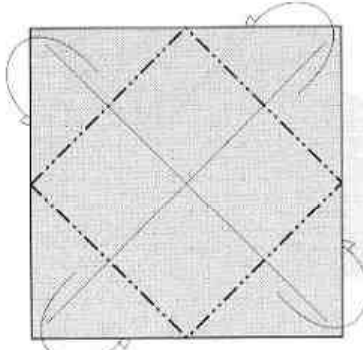

● Marrón
Beige

■ 25 cm
25 cm

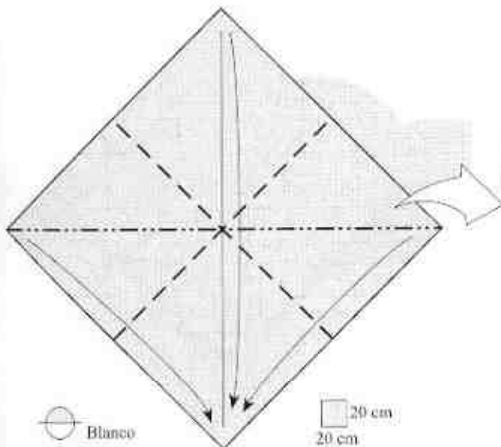
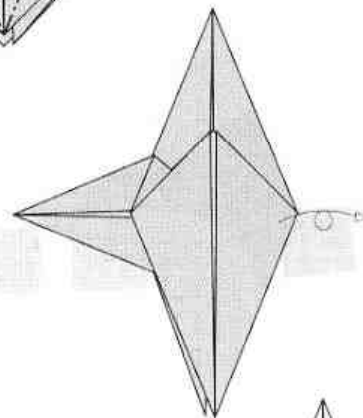
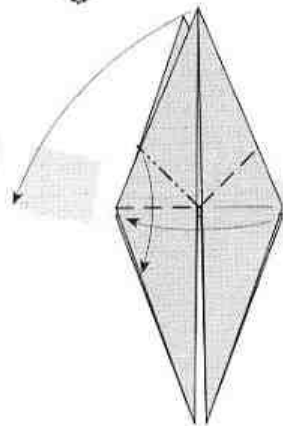
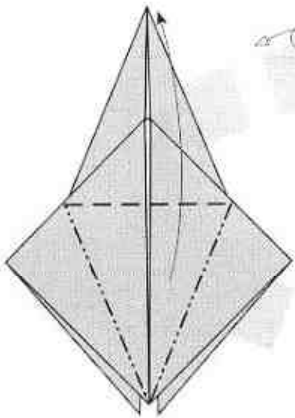
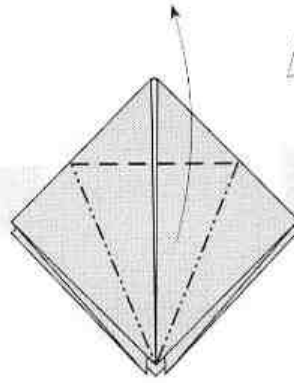
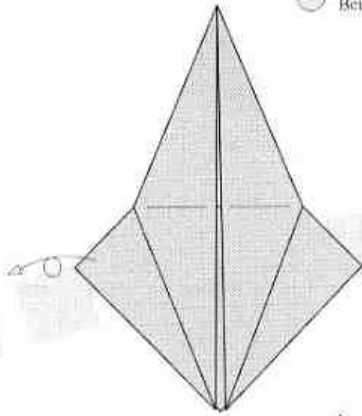
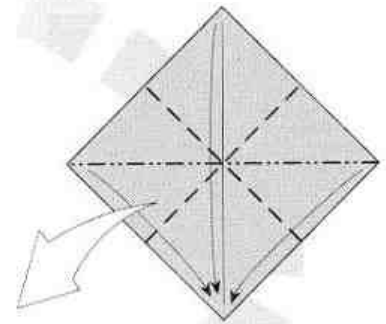

○ Blanco

■ 20 cm
20 cm

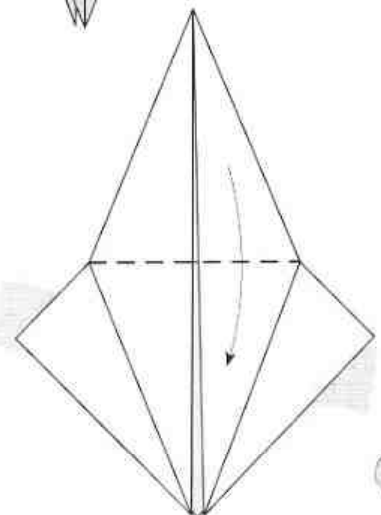
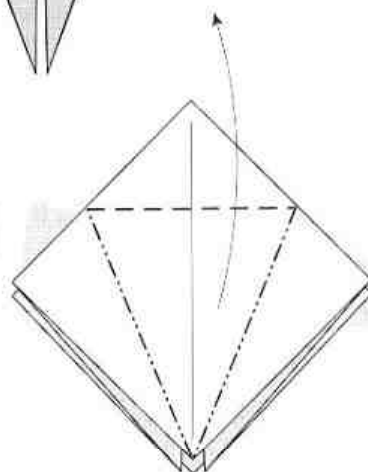

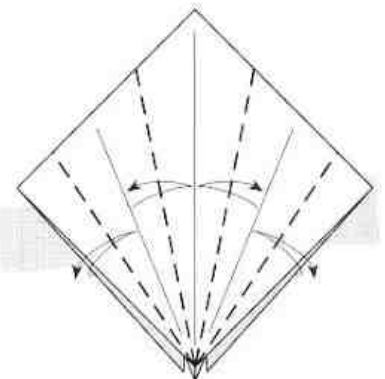
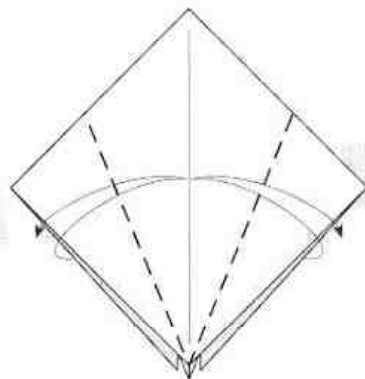
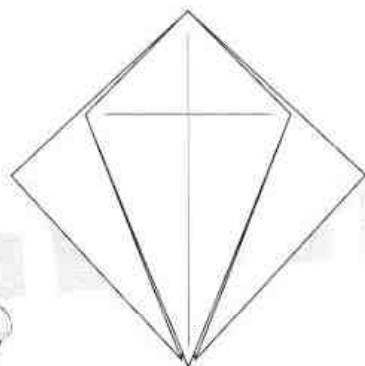
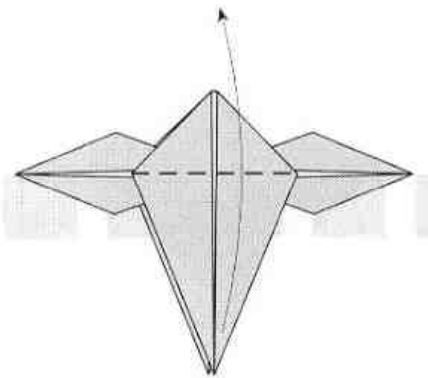
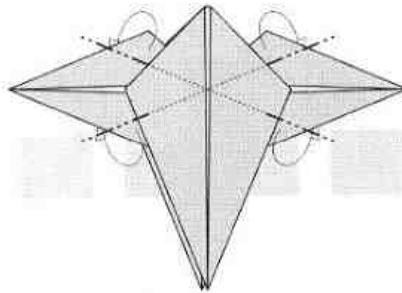
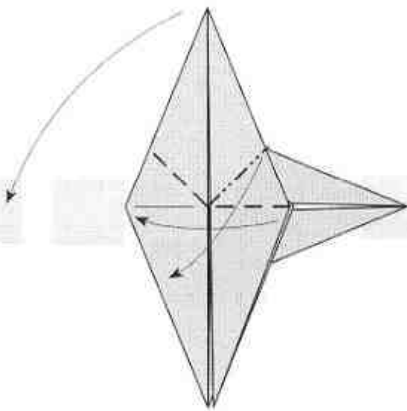
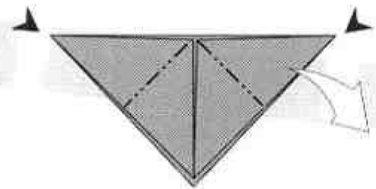
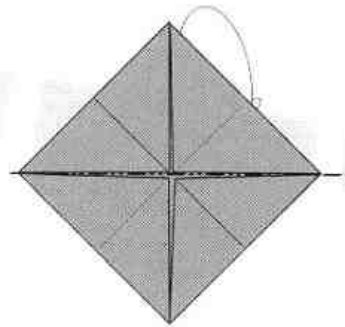
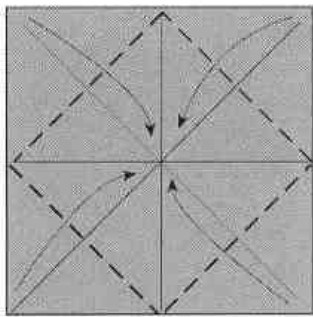
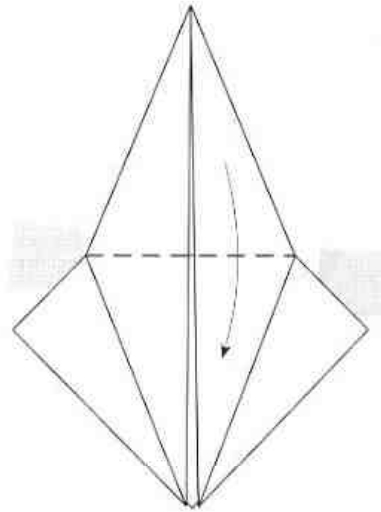
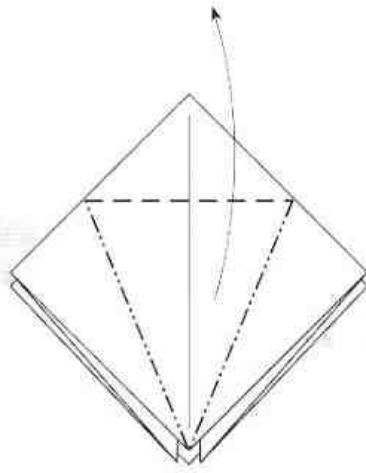
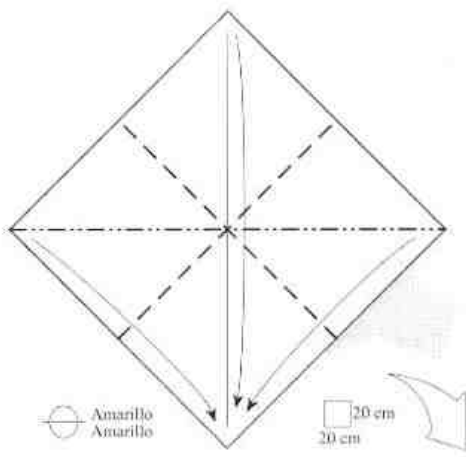

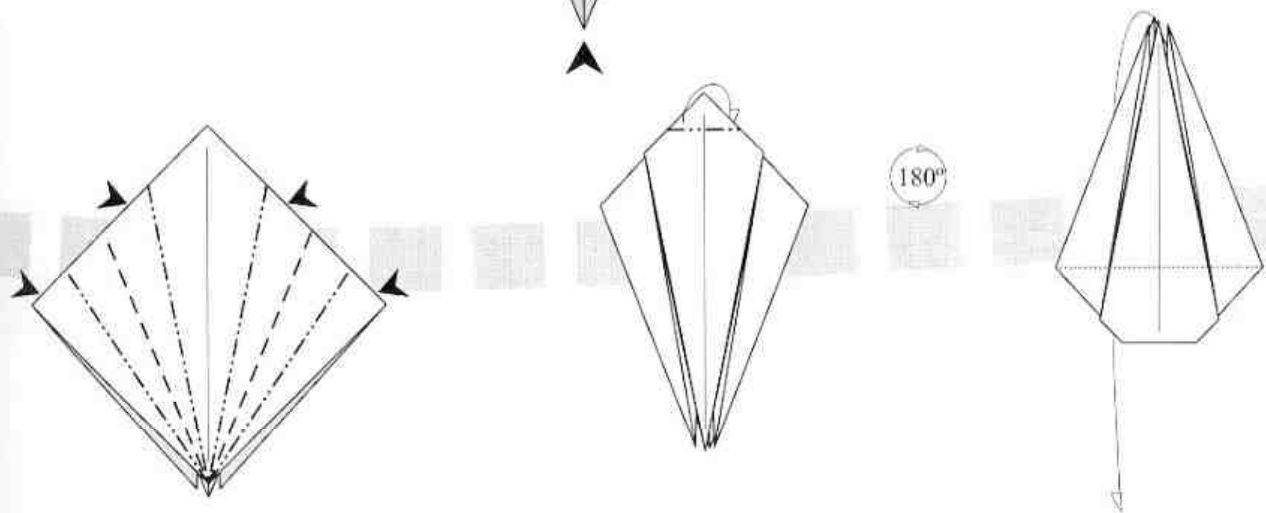
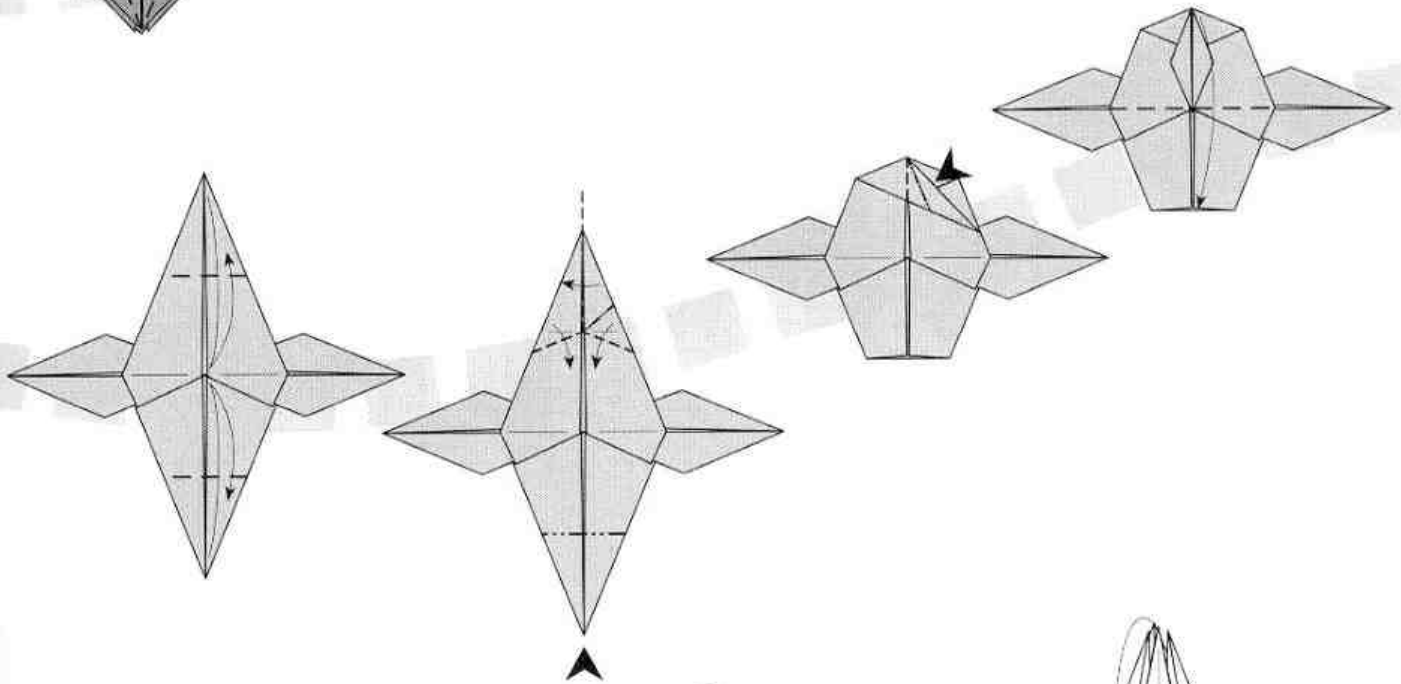
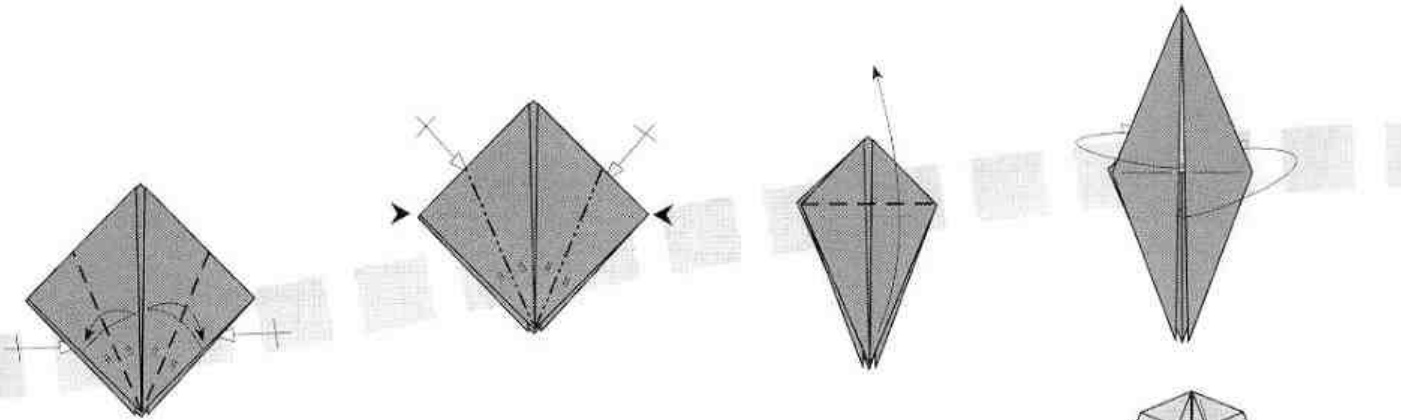
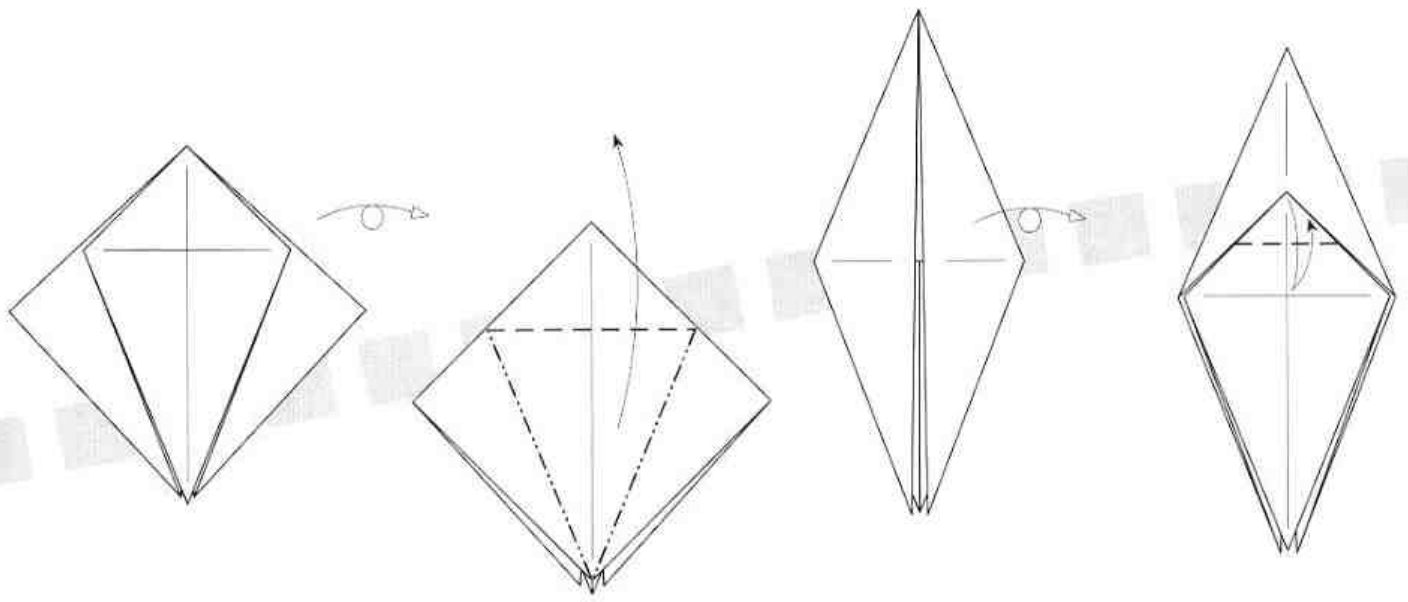

180°



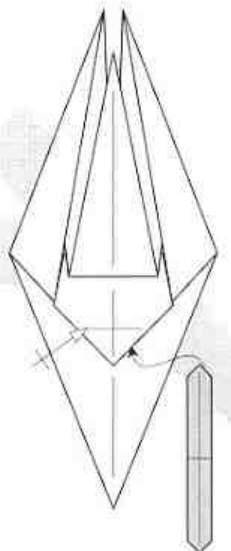
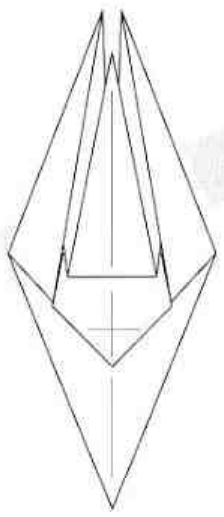
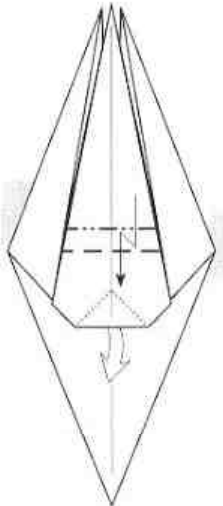
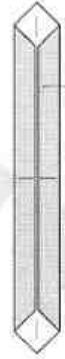
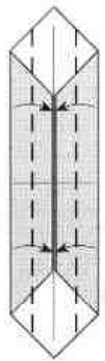
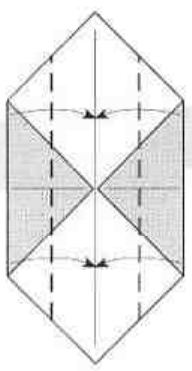
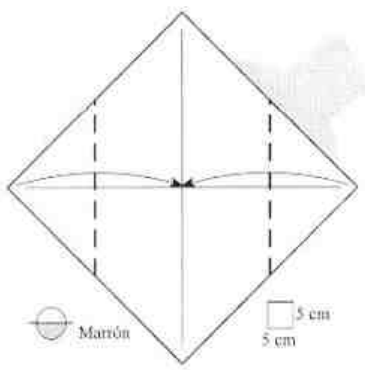
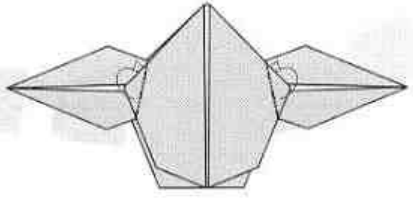
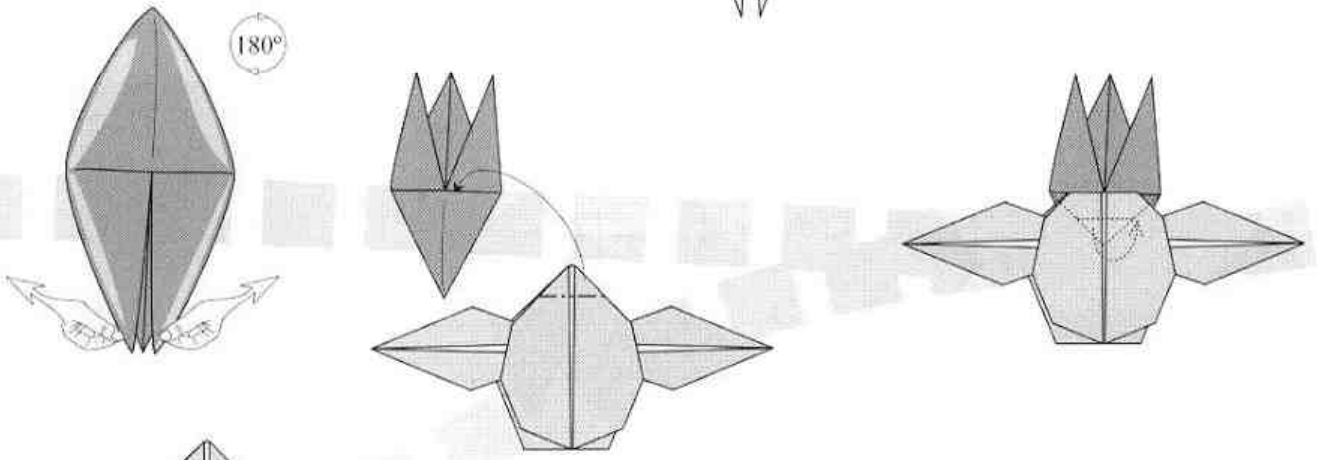
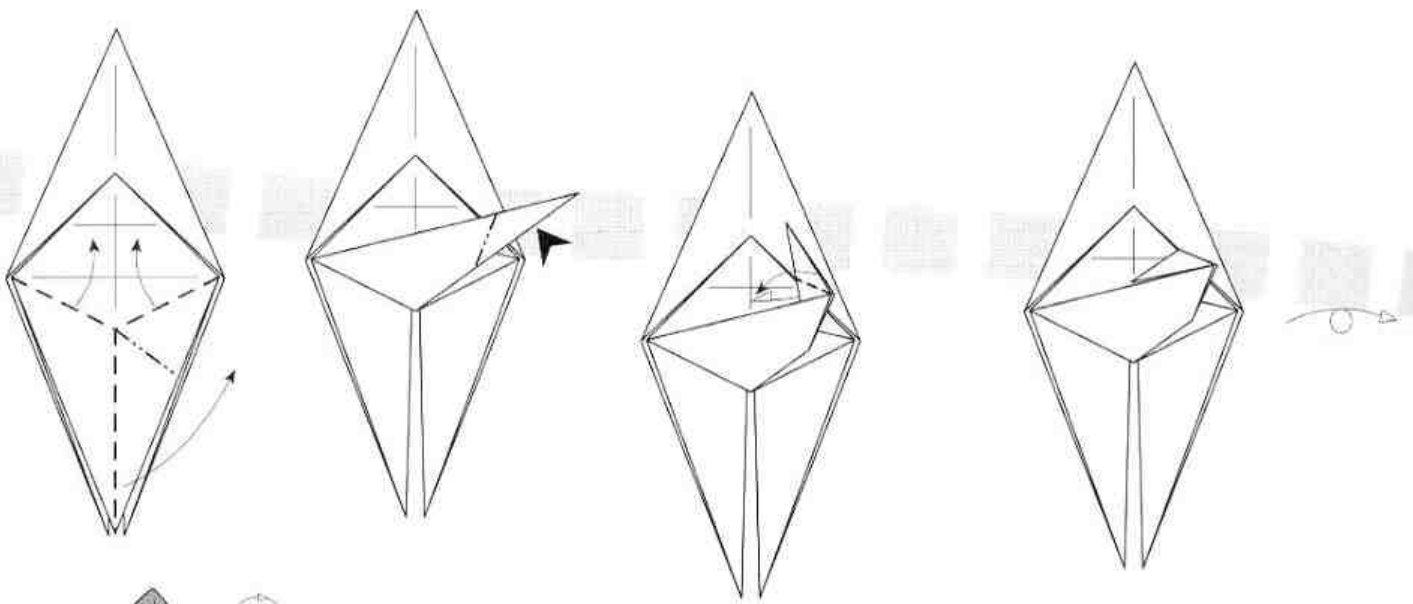

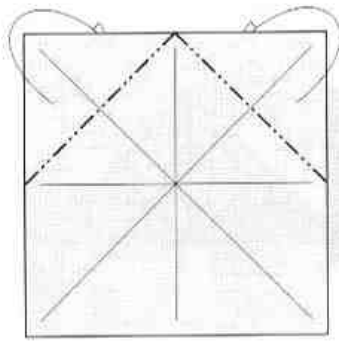
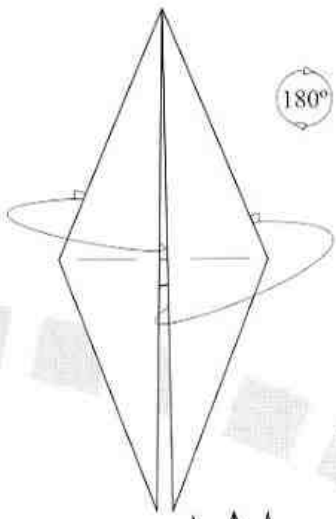

● Rojo
● Marrón

□ 10 cm
□ 10 cm

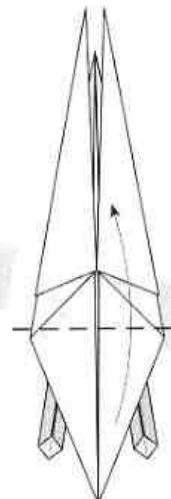
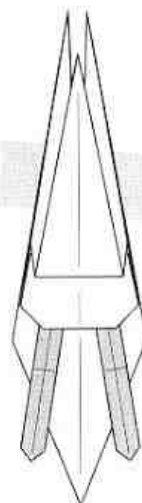
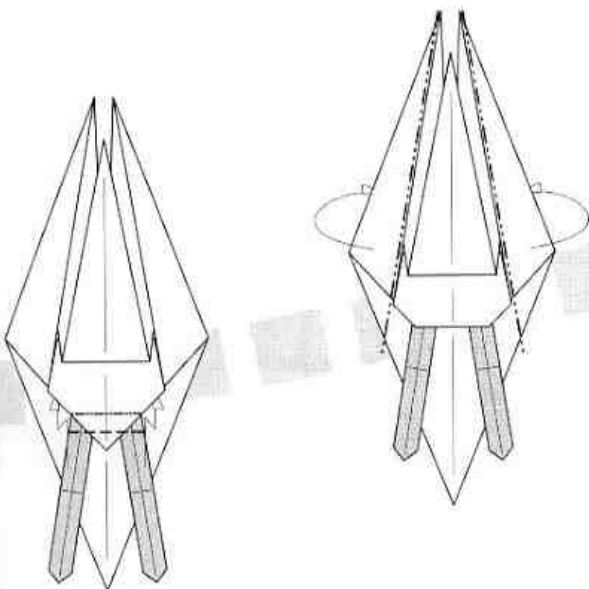
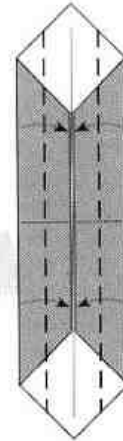
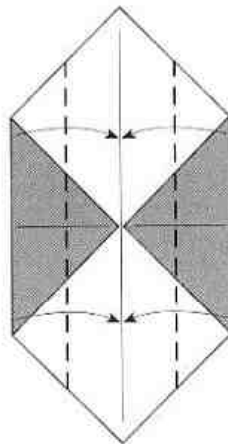
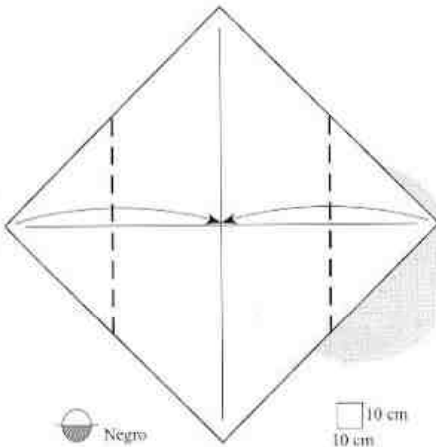
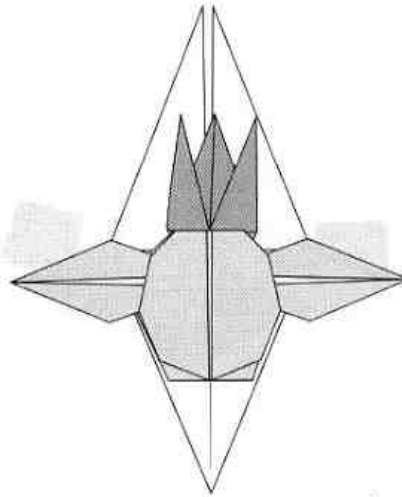
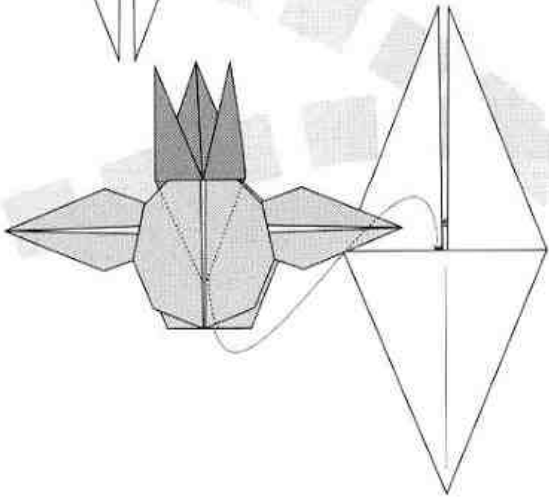
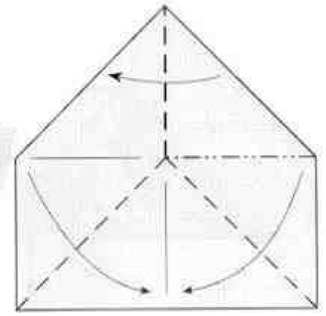

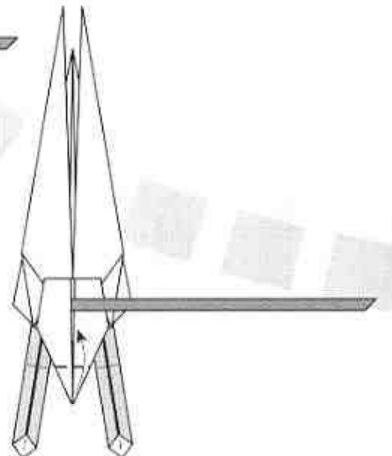
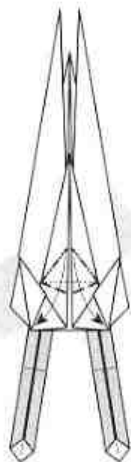
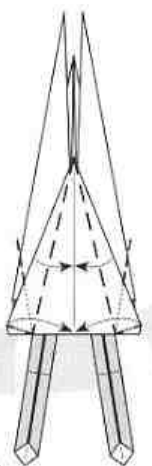
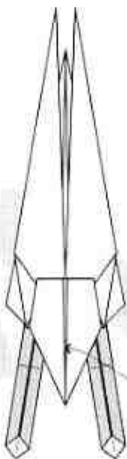
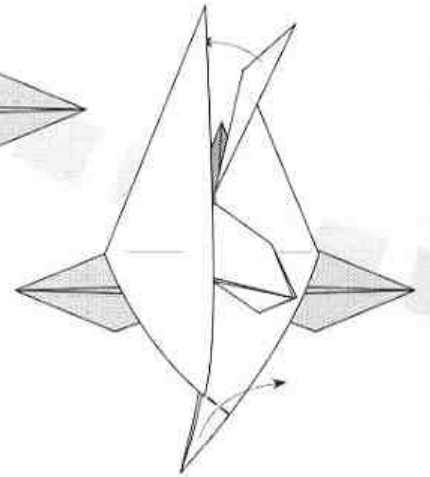
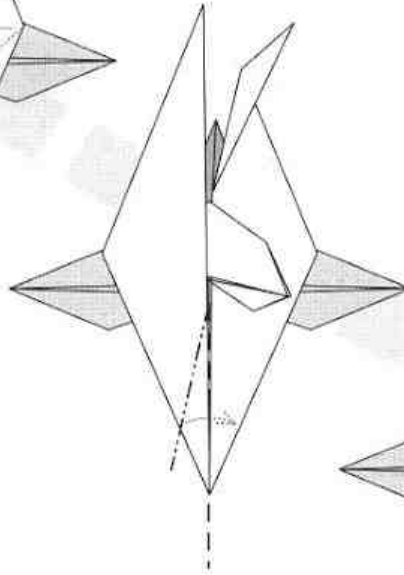
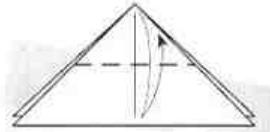
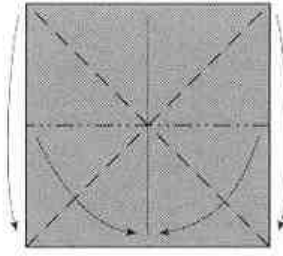
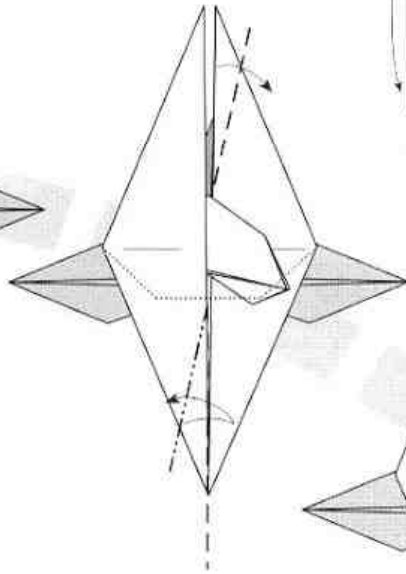
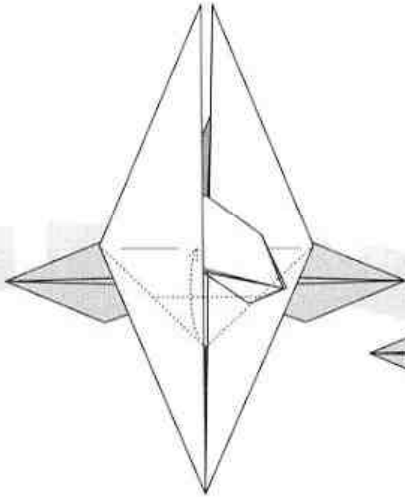
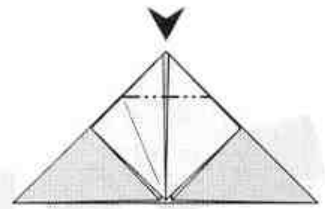
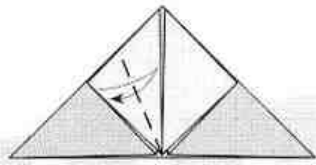
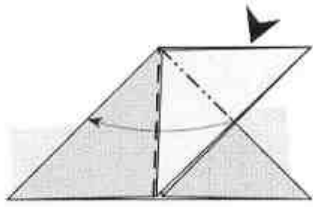

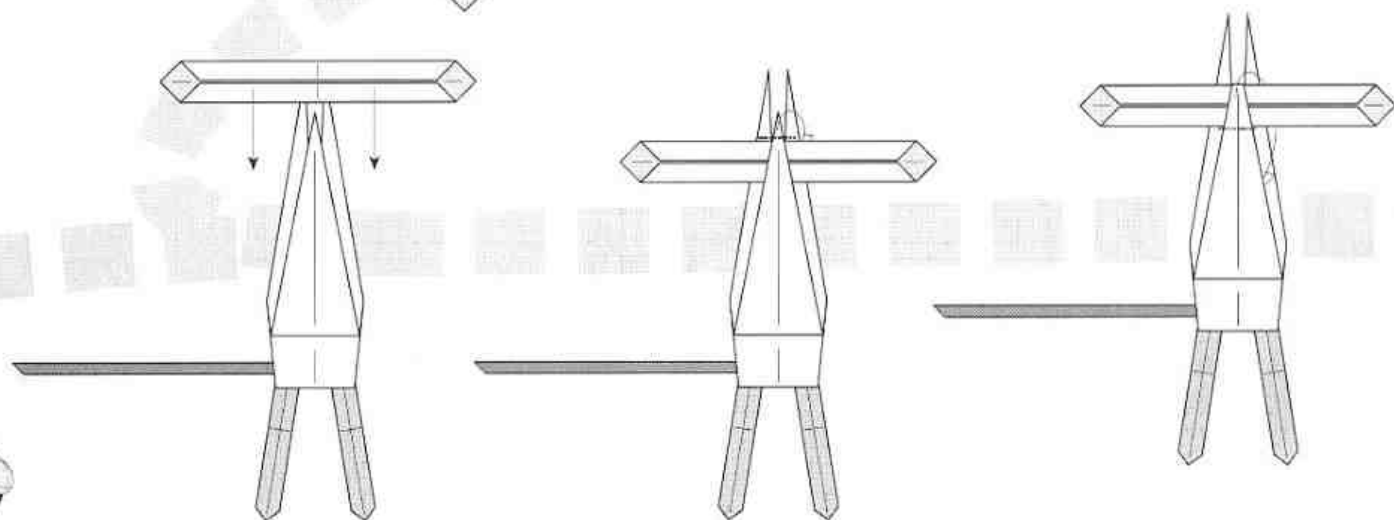
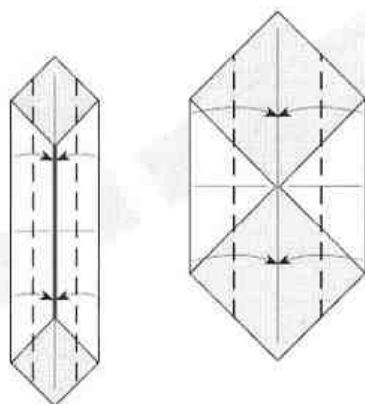
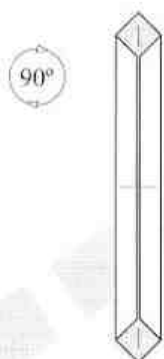
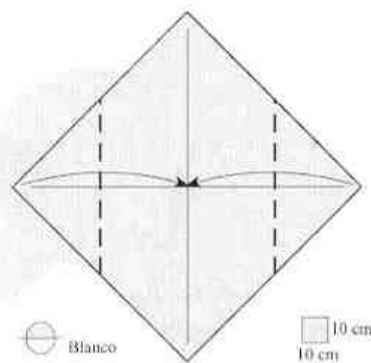
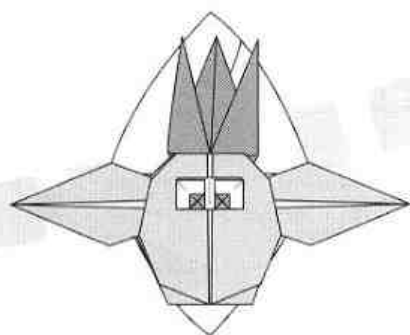
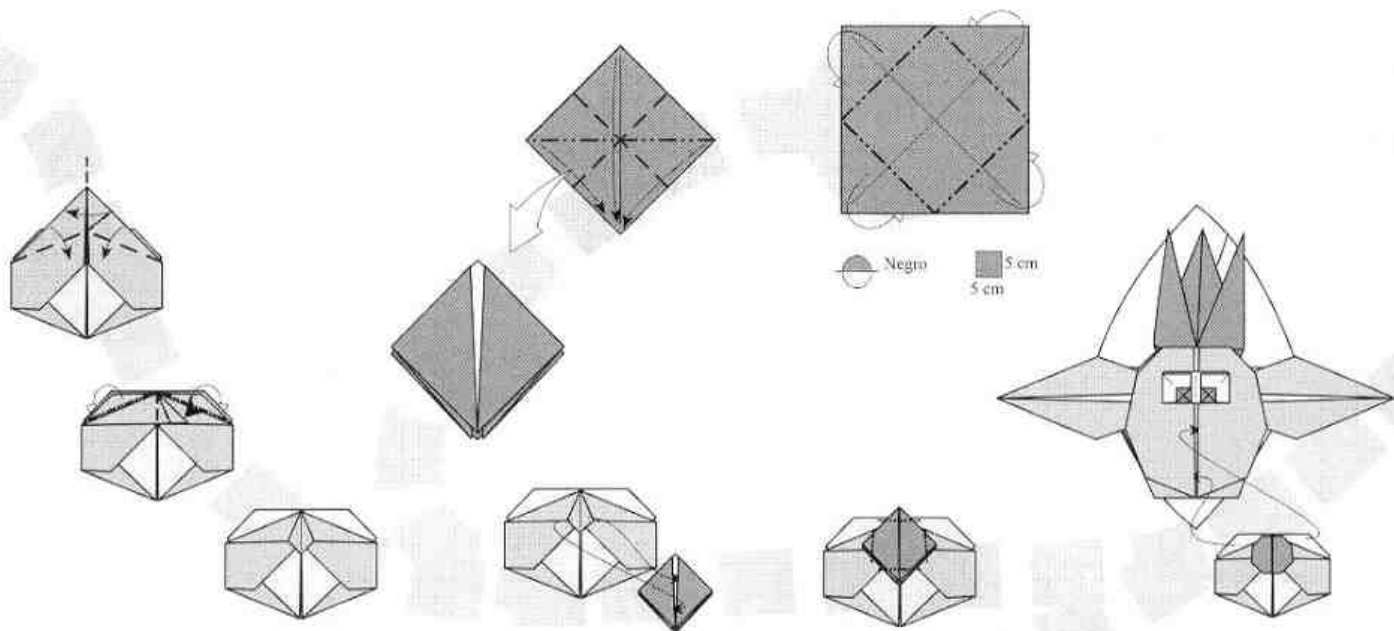

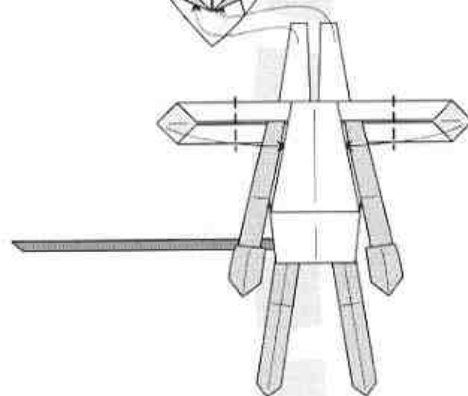
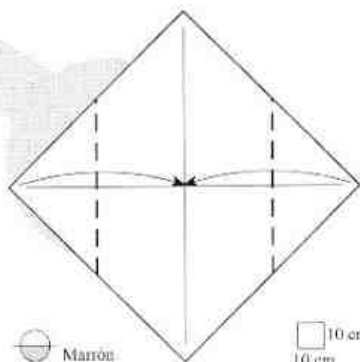
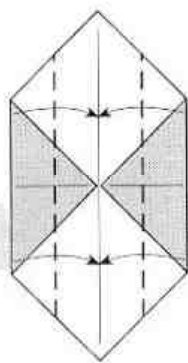
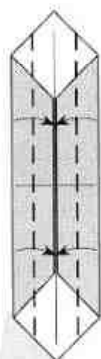
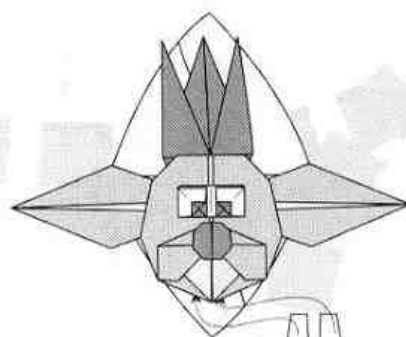
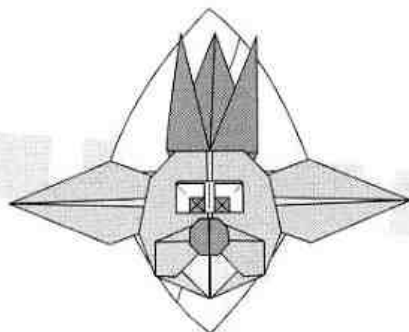
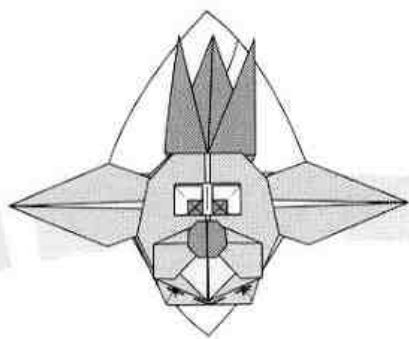

Marrón

10 cm
10 cm

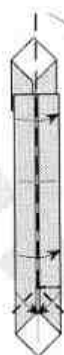

90°

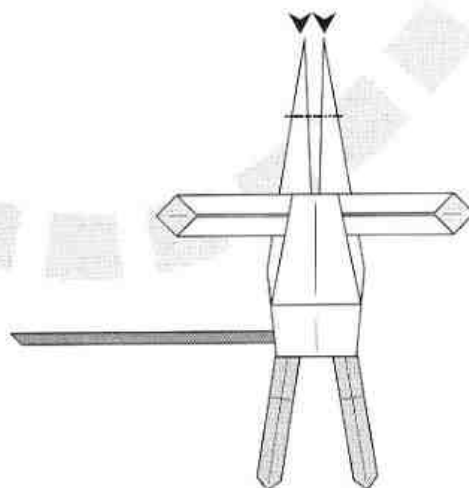
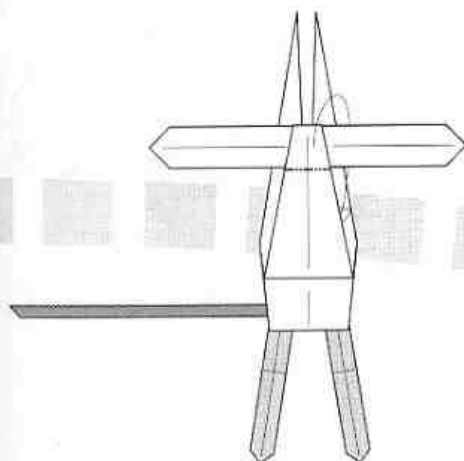
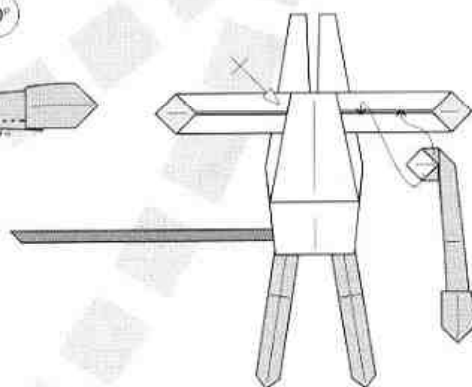

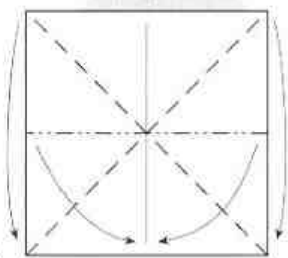
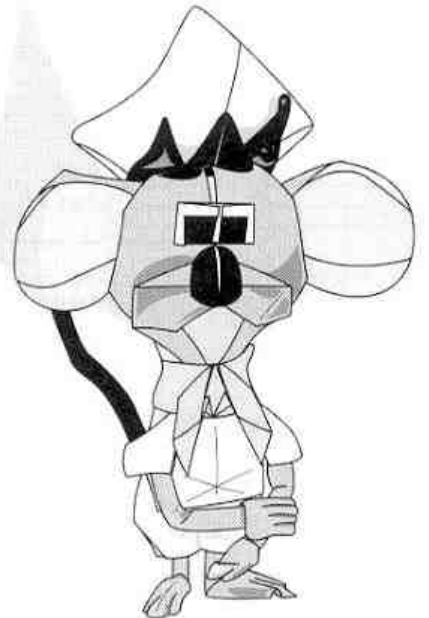
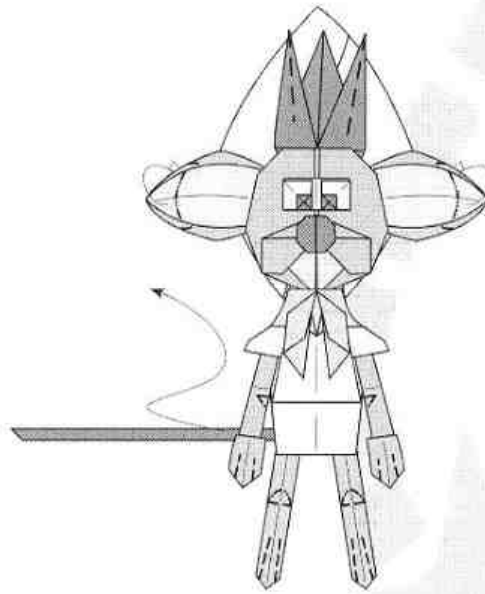
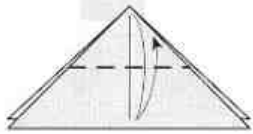
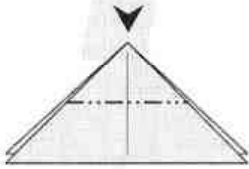
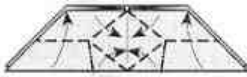
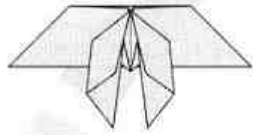
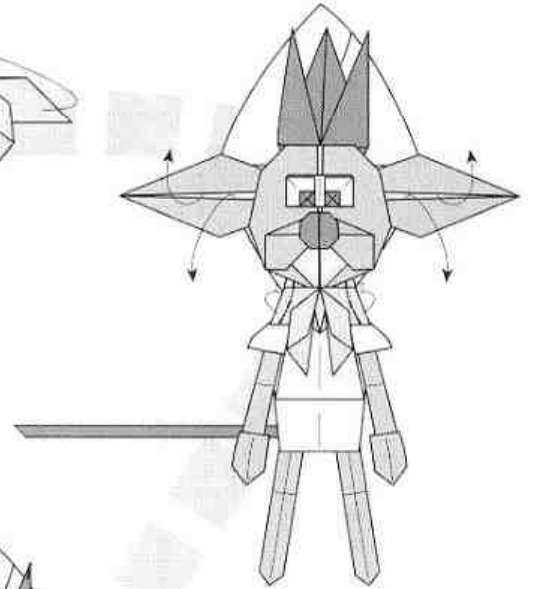
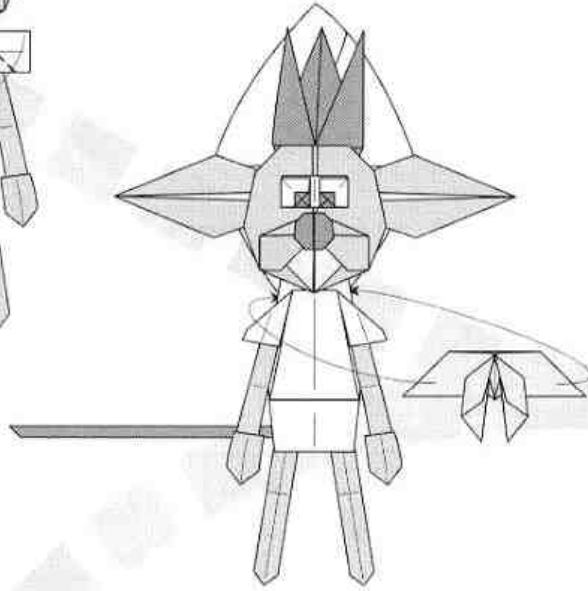
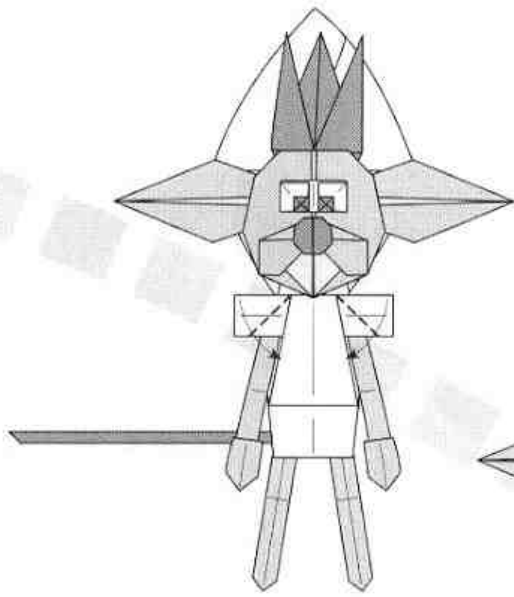

● Rojo

□ 7,5 cm
7,5 cm

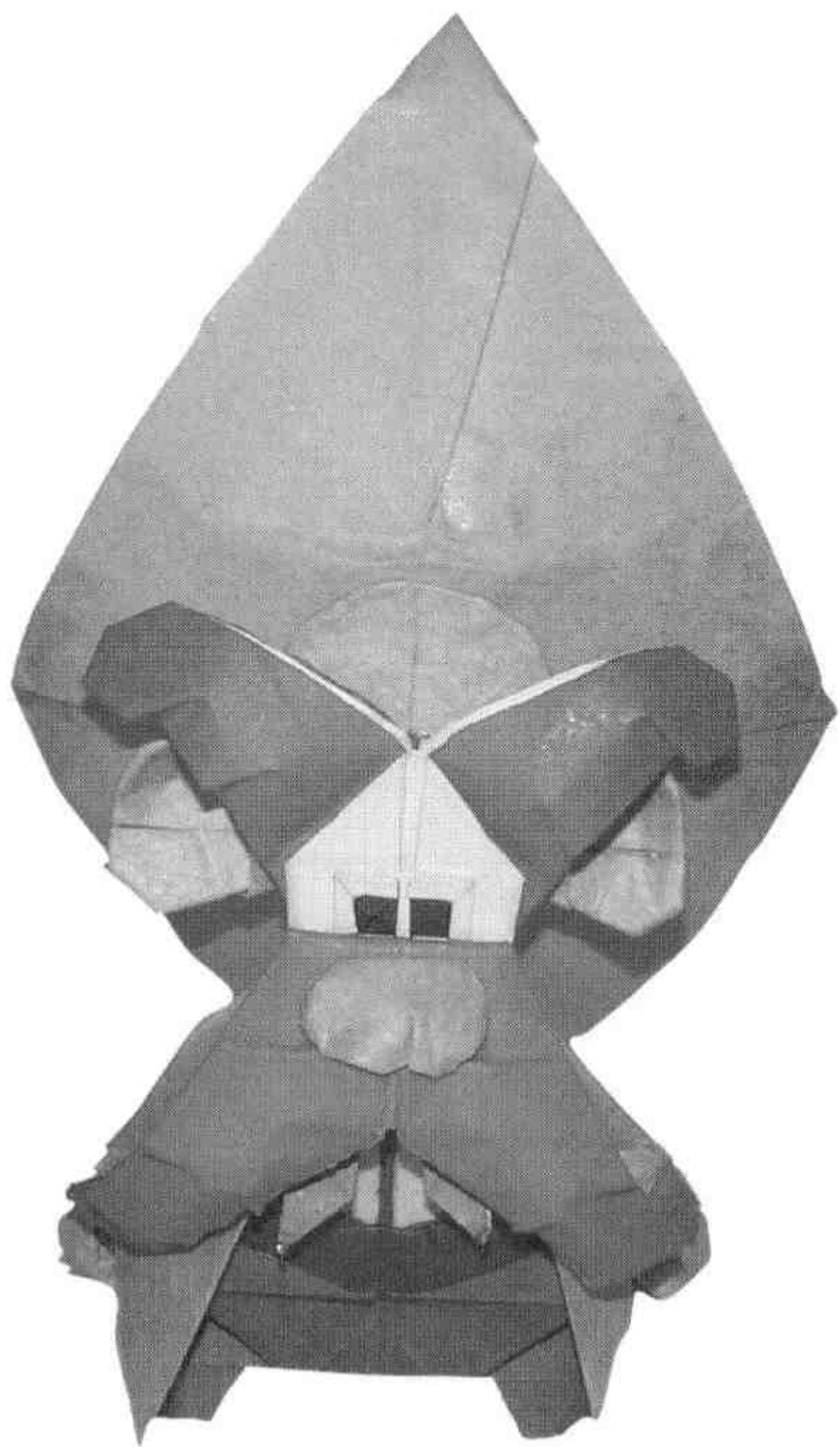

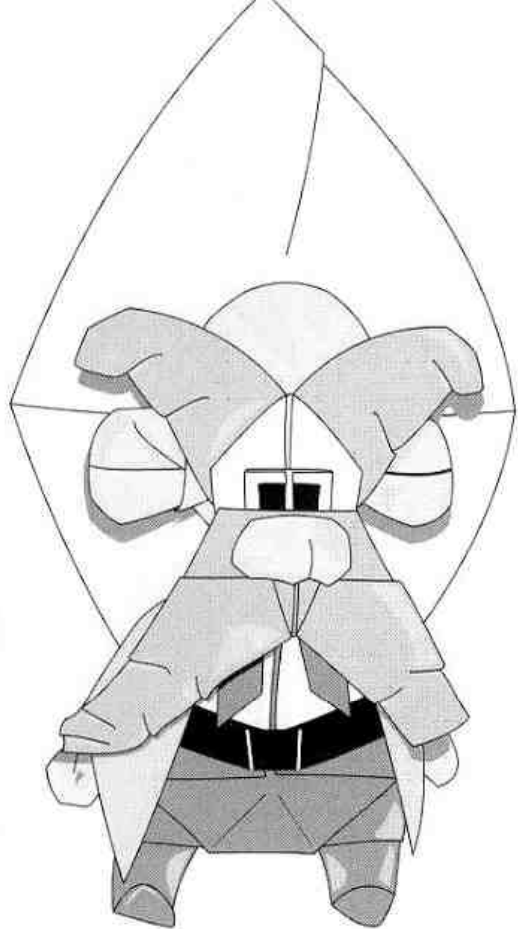

Utilizando las medidas recomendadas, se obtiene un modelo final de 21 cms.

Autor:	Halle
Nivel de dificultad:	Medio-Alto
Número de piezas:	14
Forma de las piezas:	Cuadrados

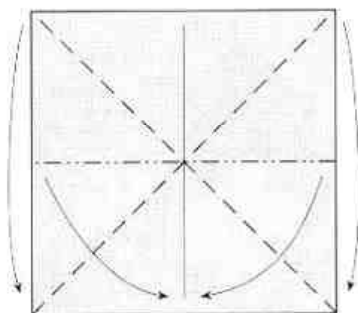

 Rosa
 Rojo
 15 cm
 15 cm

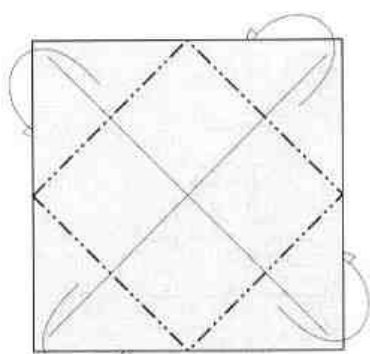

 rosa
 20 cm
 20 cm

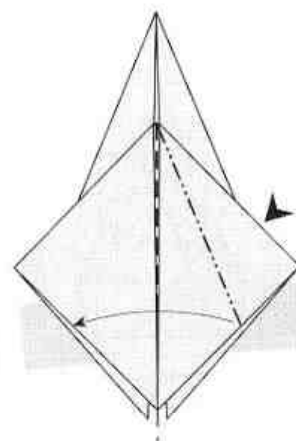
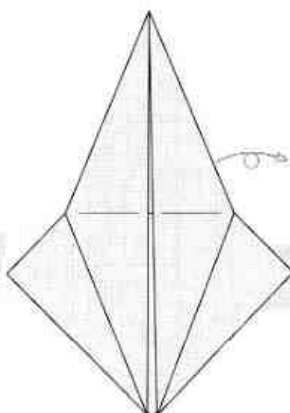
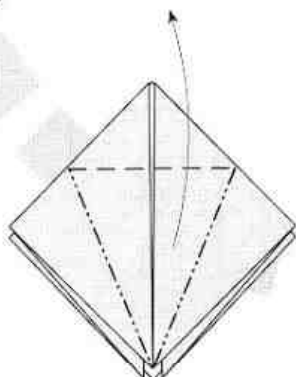
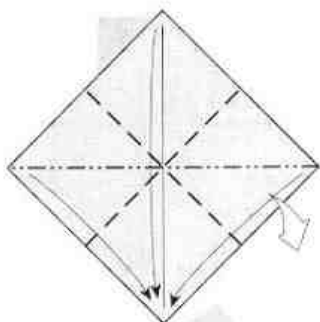
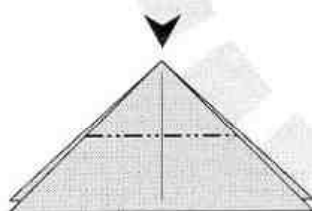
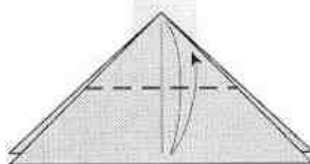

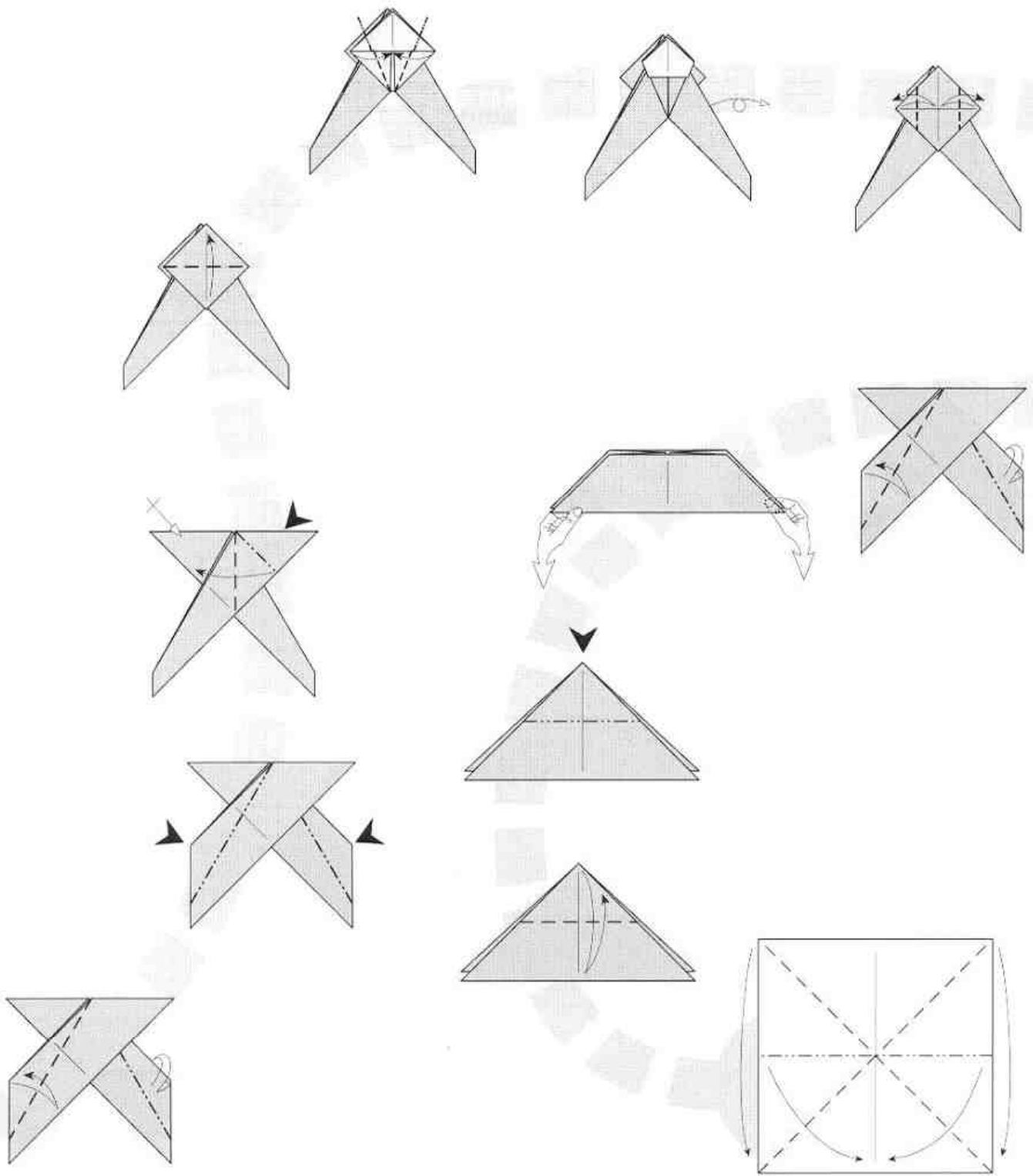

Blanco
 Rojo
 15 cm
 15 cm

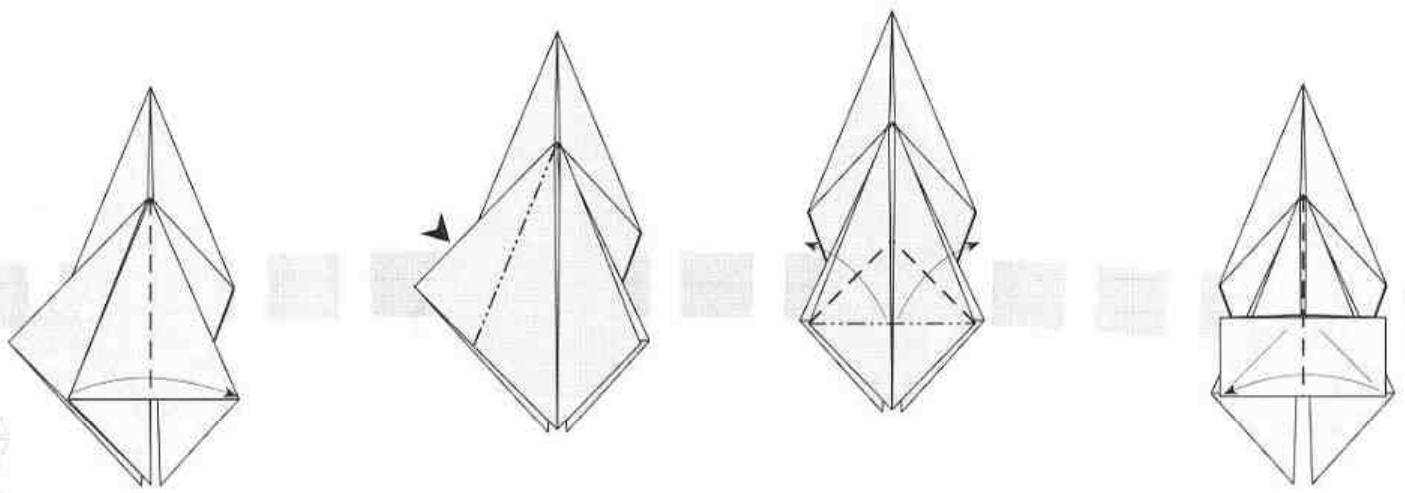

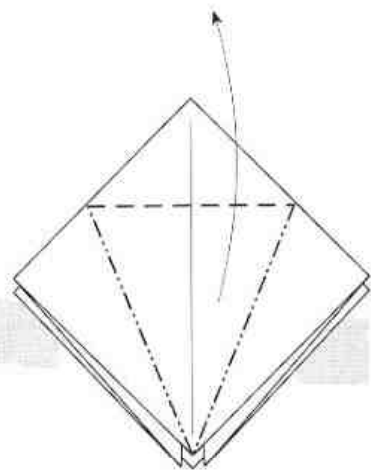
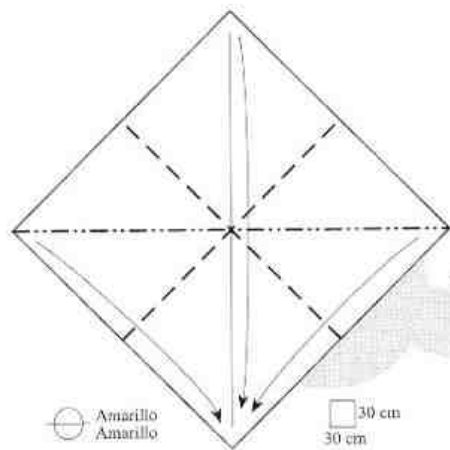
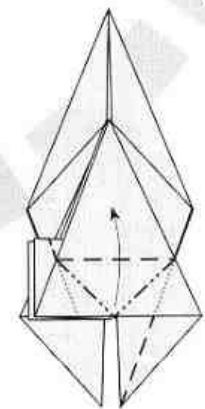
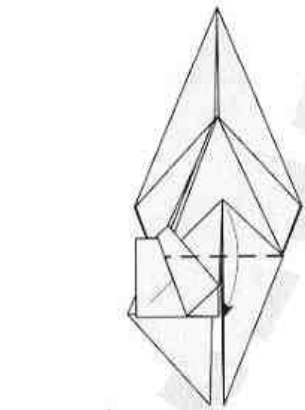
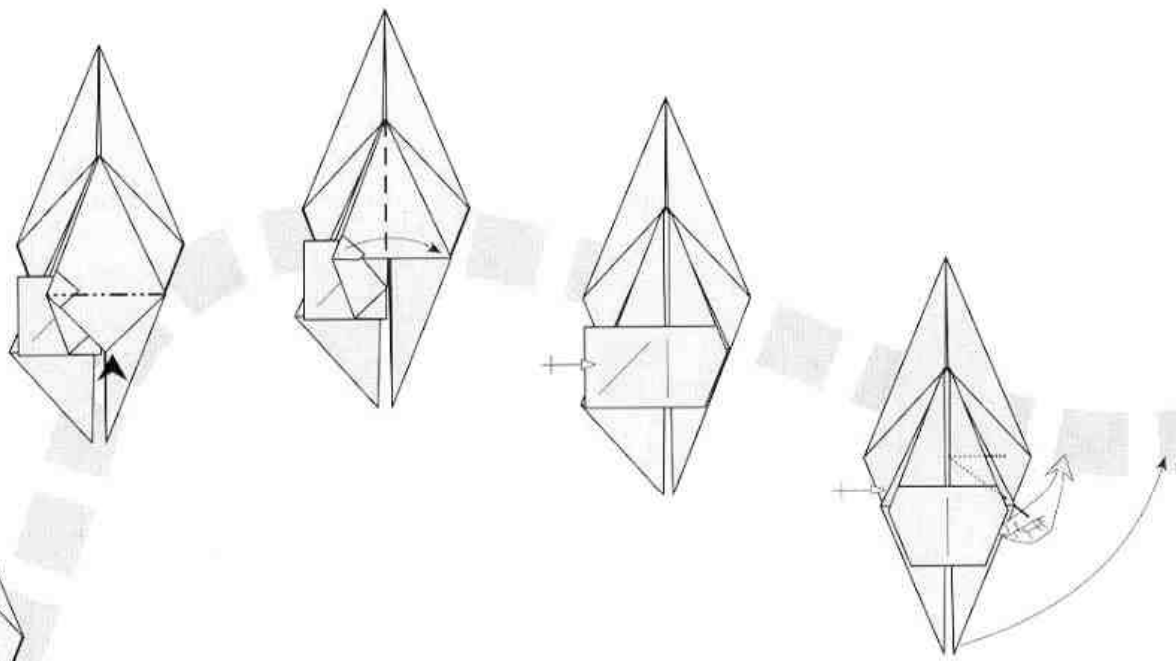
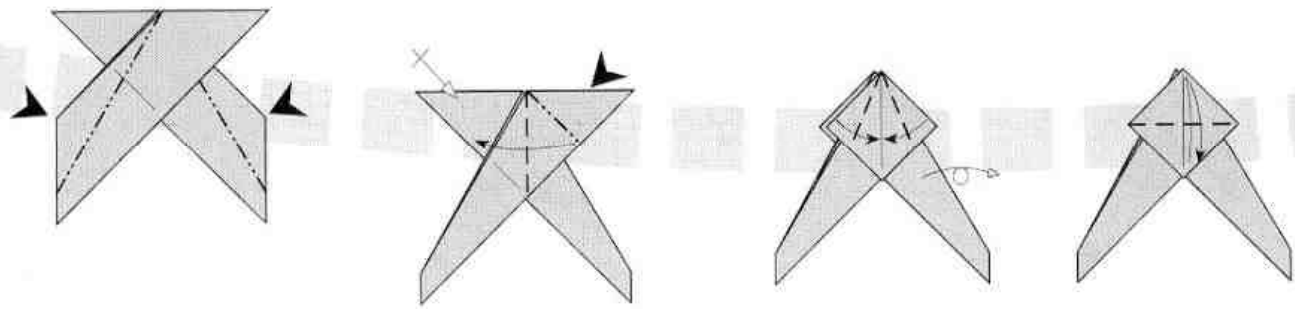
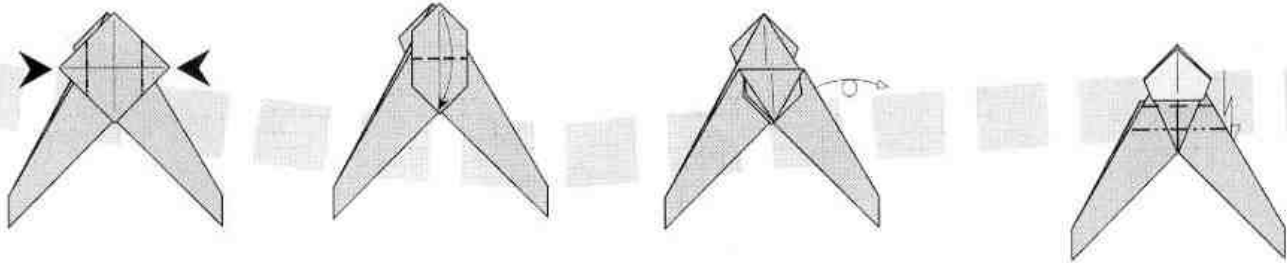

○ Amazillo
Amarillo

□ 30 cm
30 cm



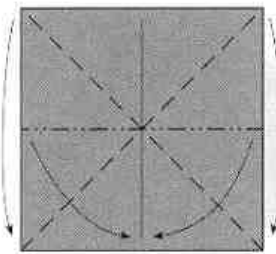
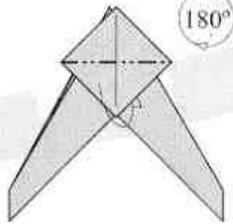
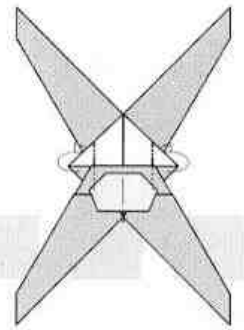
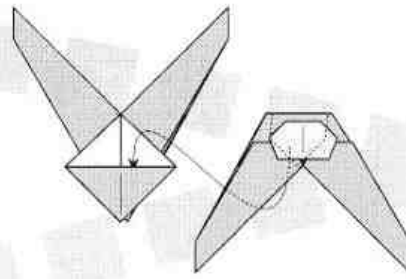
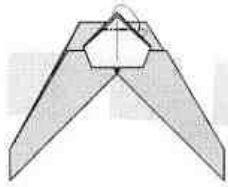

● Negro
● Blanco

■ 3,75 cm
■ 3,75 cm

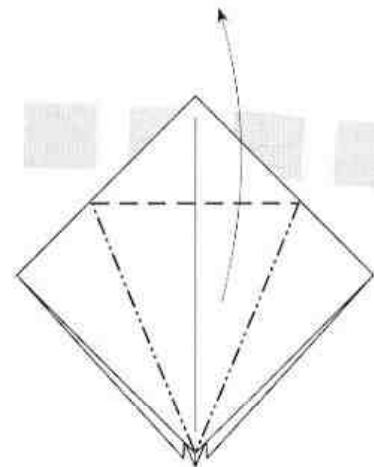
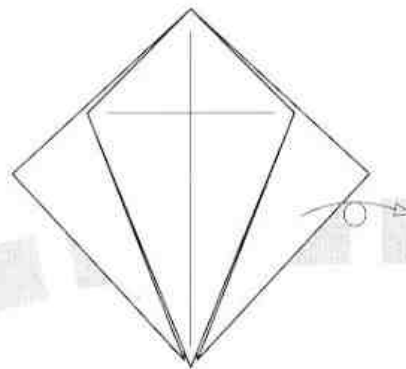
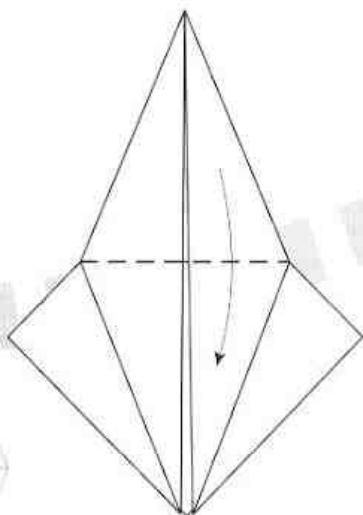
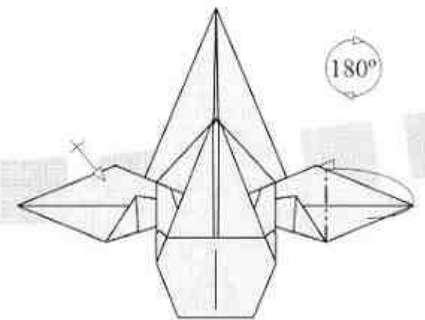
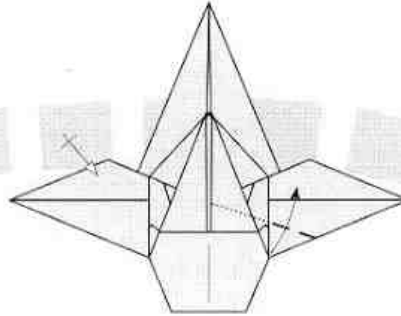
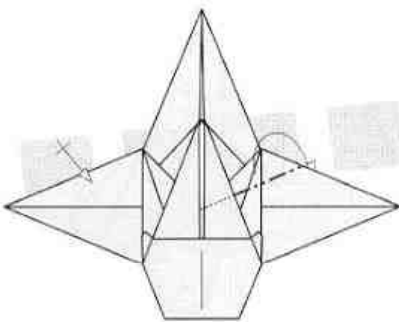
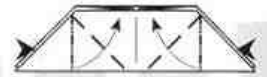
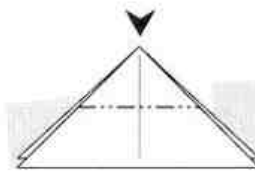
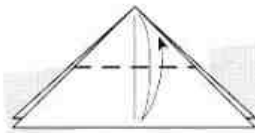

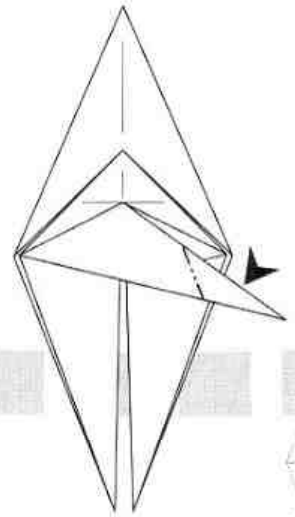
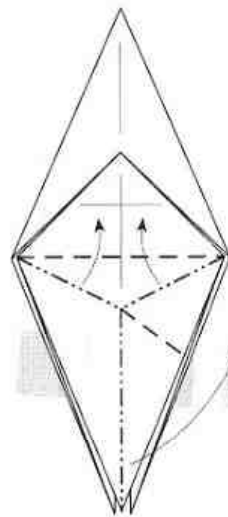
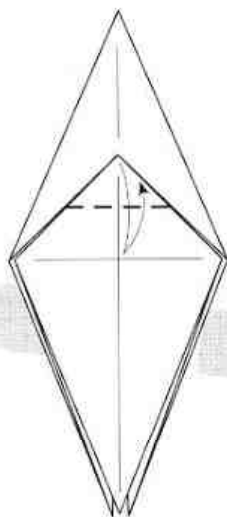
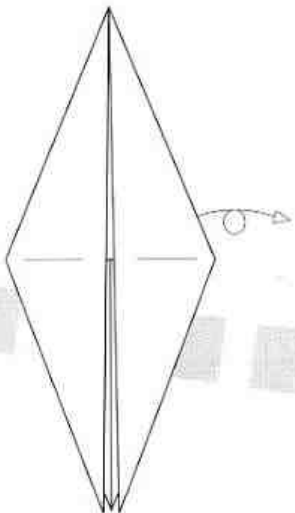
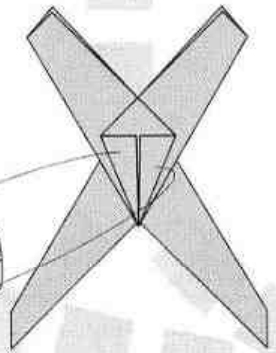
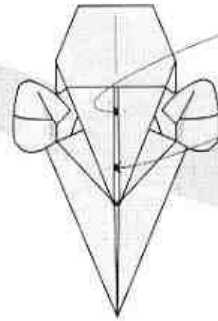
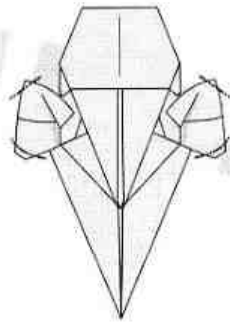
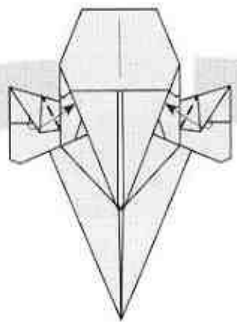
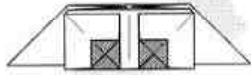
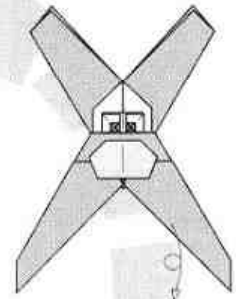
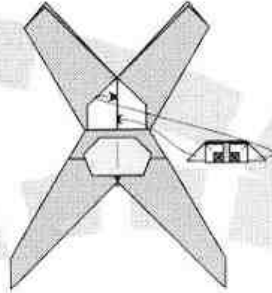
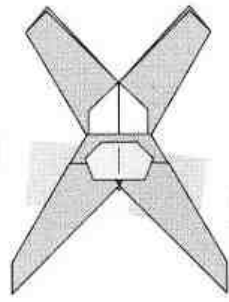
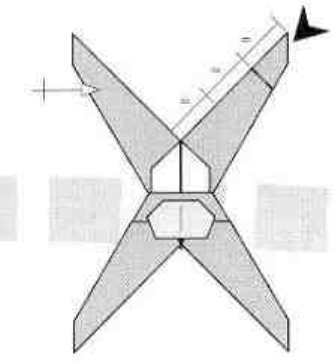

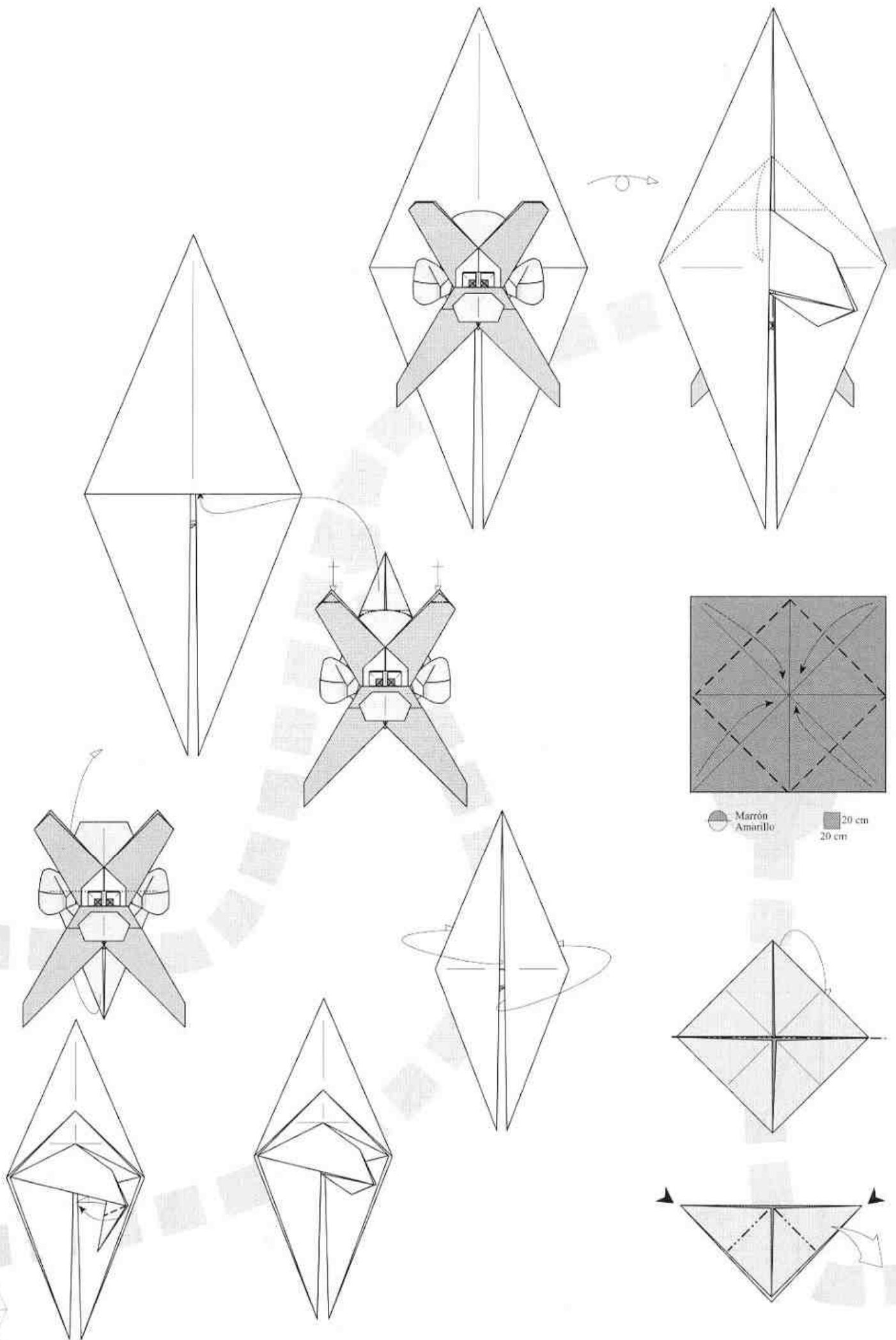

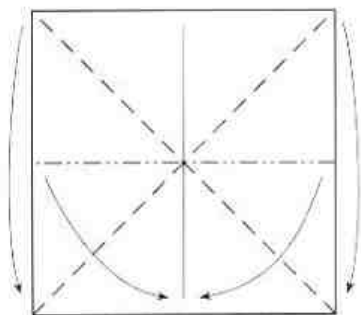
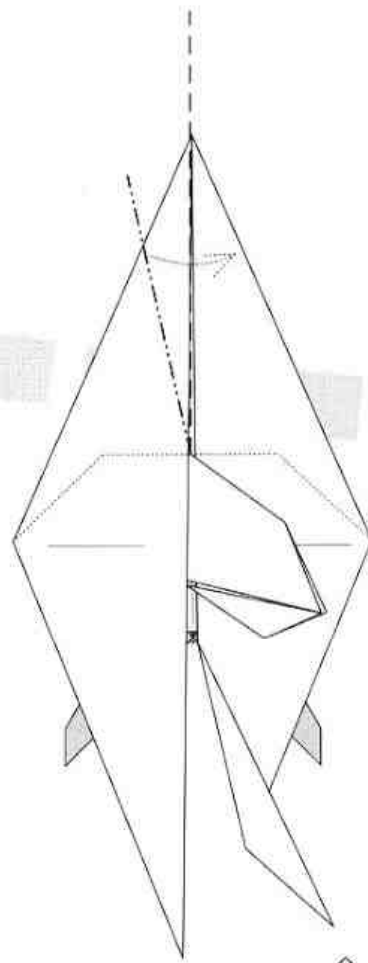
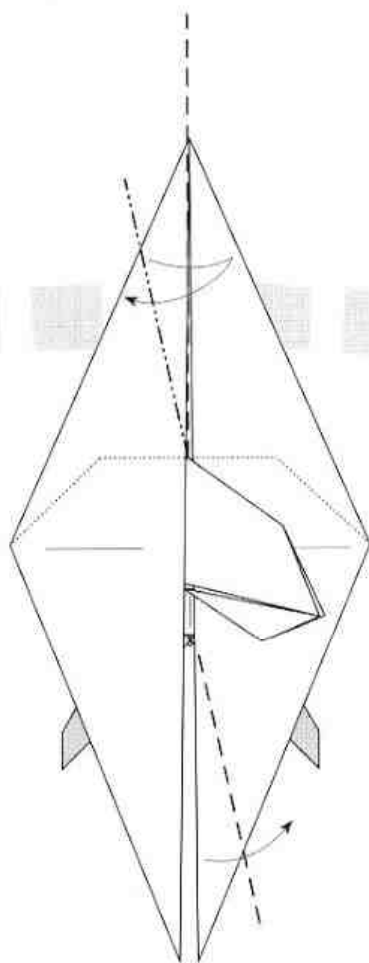

● Negro

□ 7,5 cm
7,5 cm

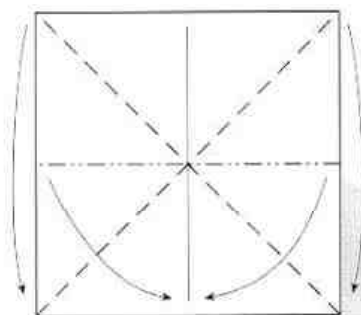

● Verde

□ 7,5 cm
7,5 cm

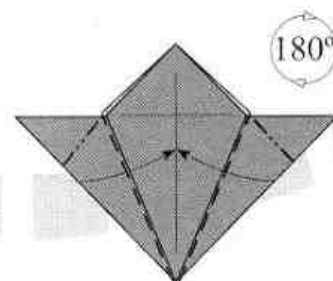
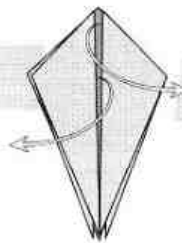
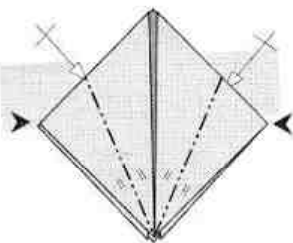
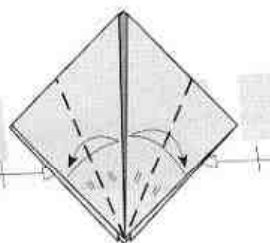
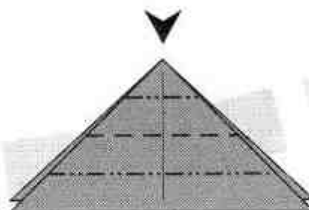
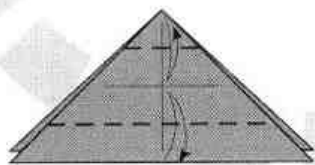
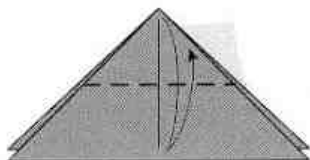
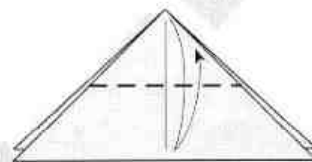
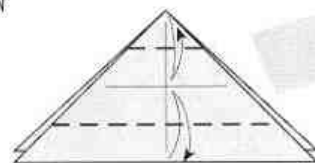

180°



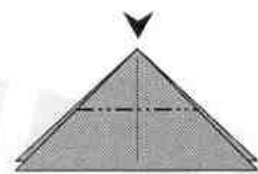
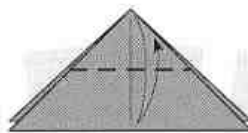
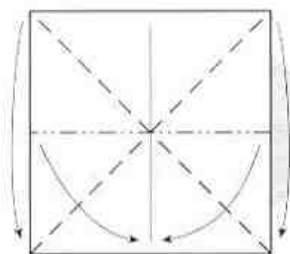
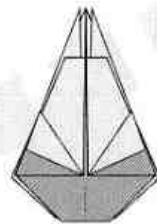
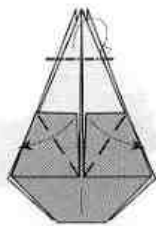
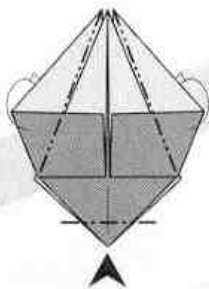
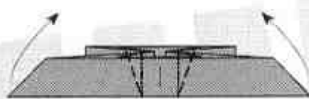
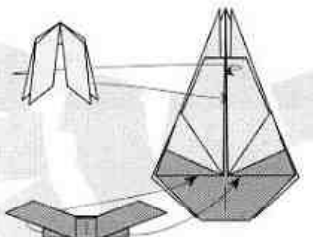
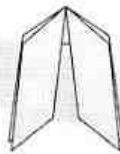
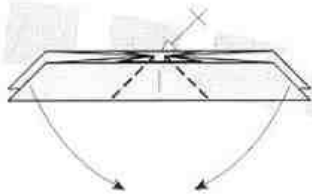
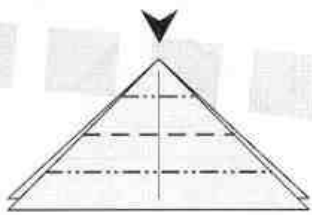
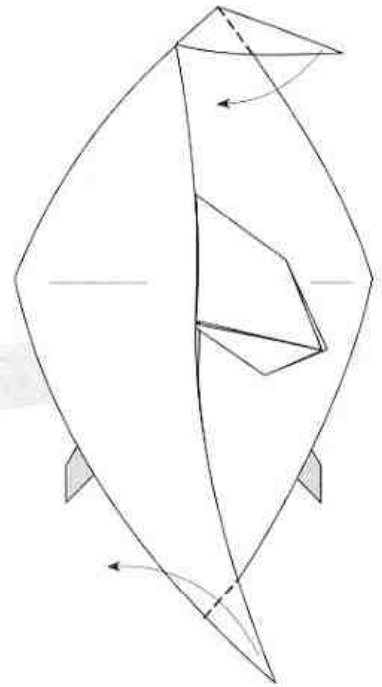
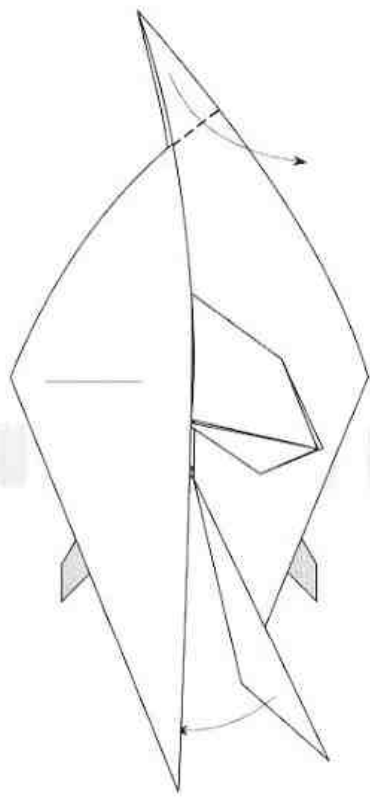

● Marrón

□ 15 cm
15 cm



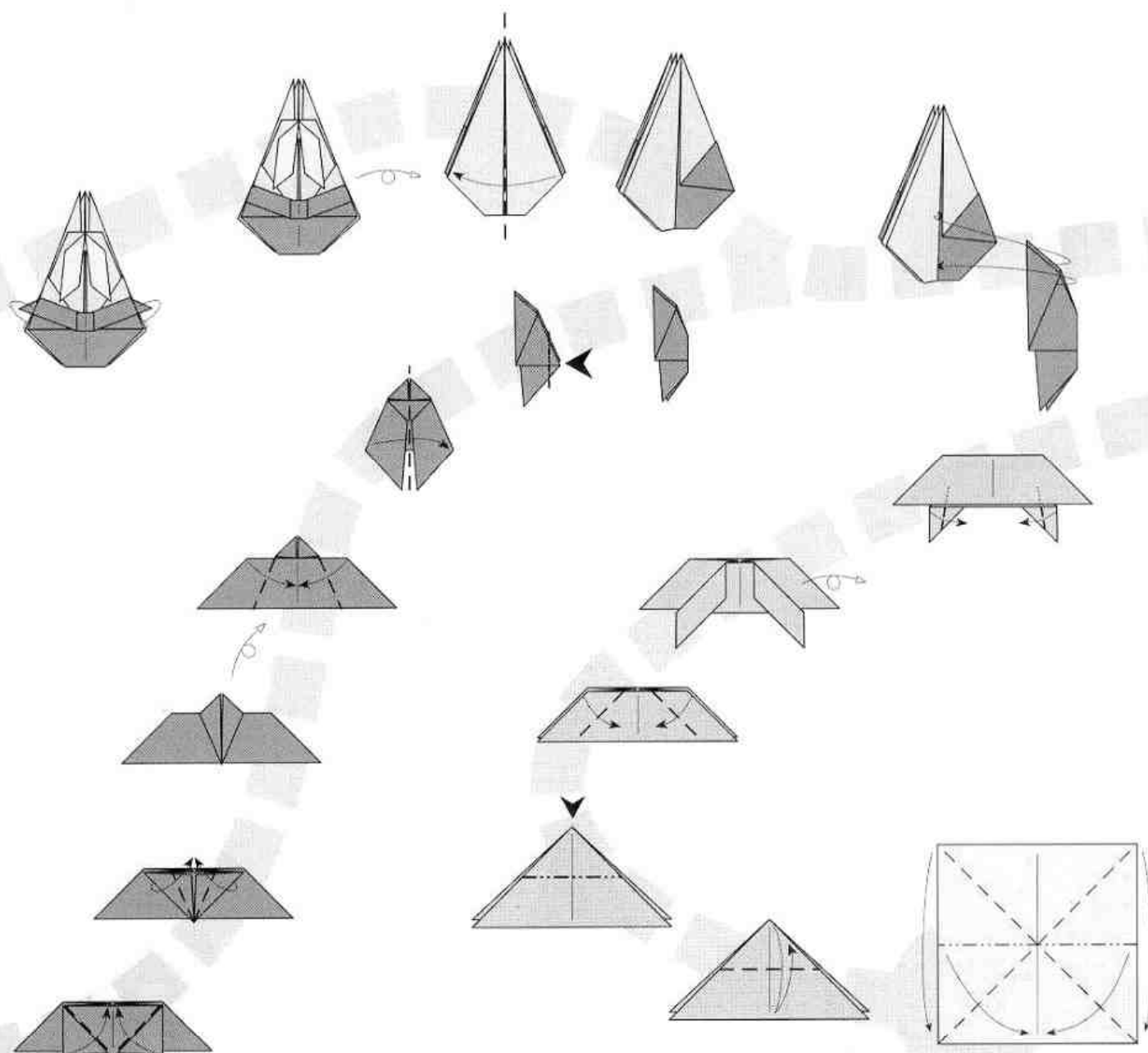
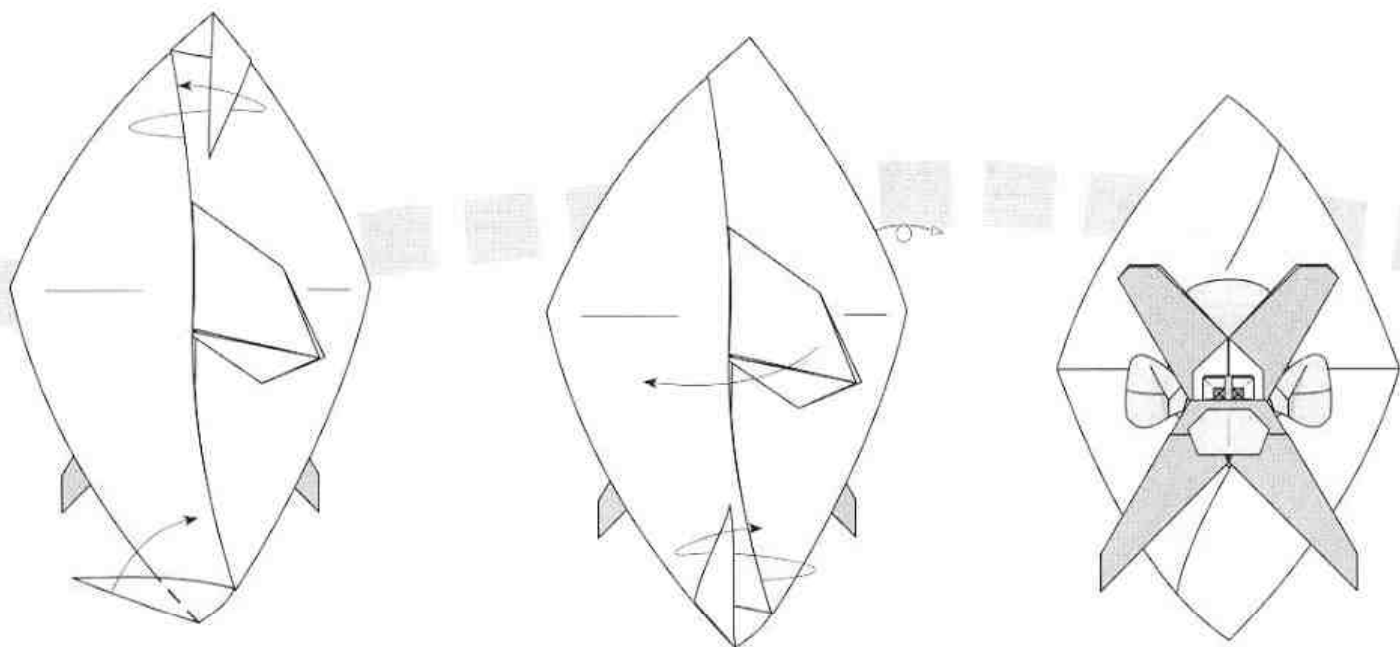

Rosa
 Violeta

15 cm
 15 cm



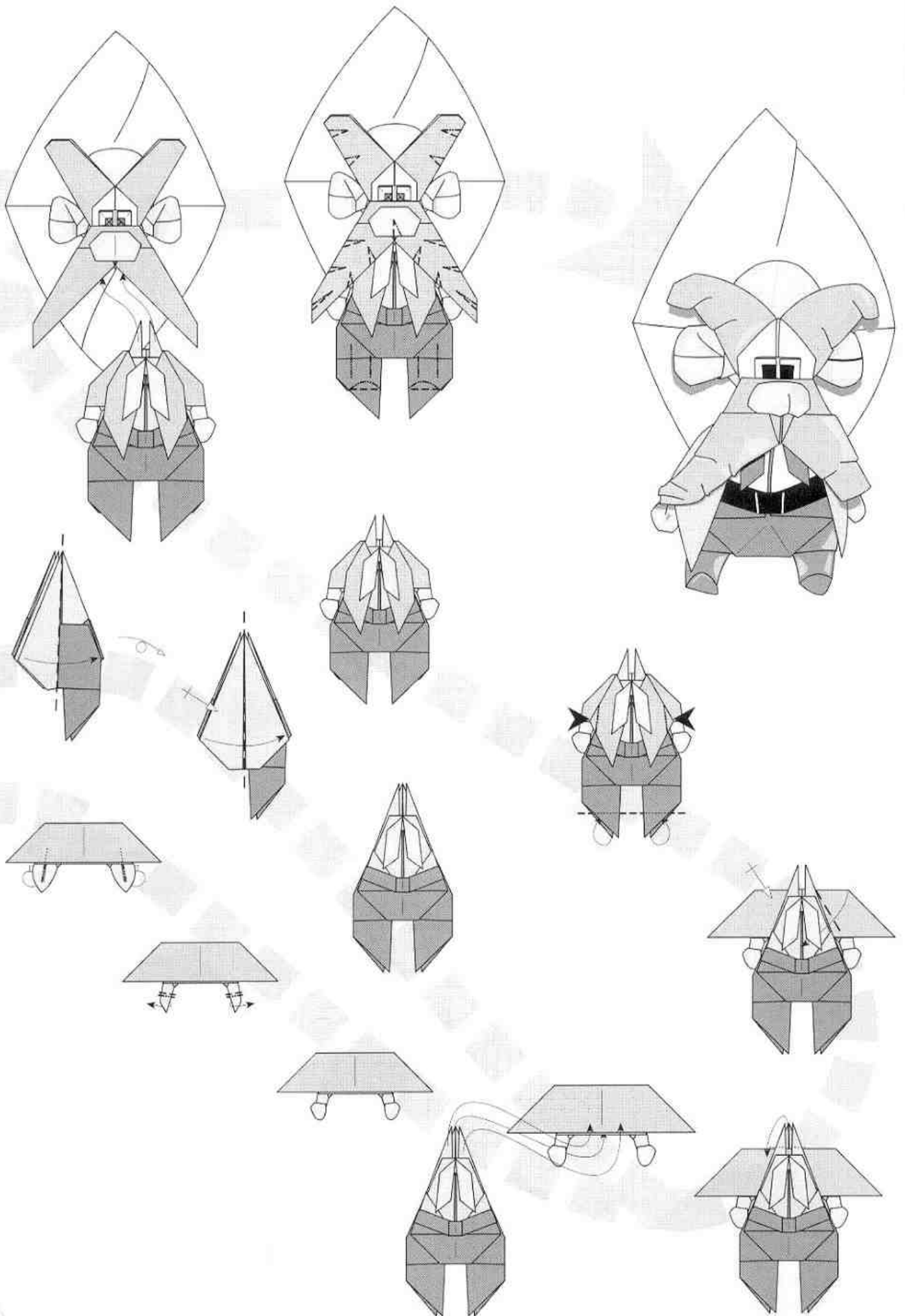

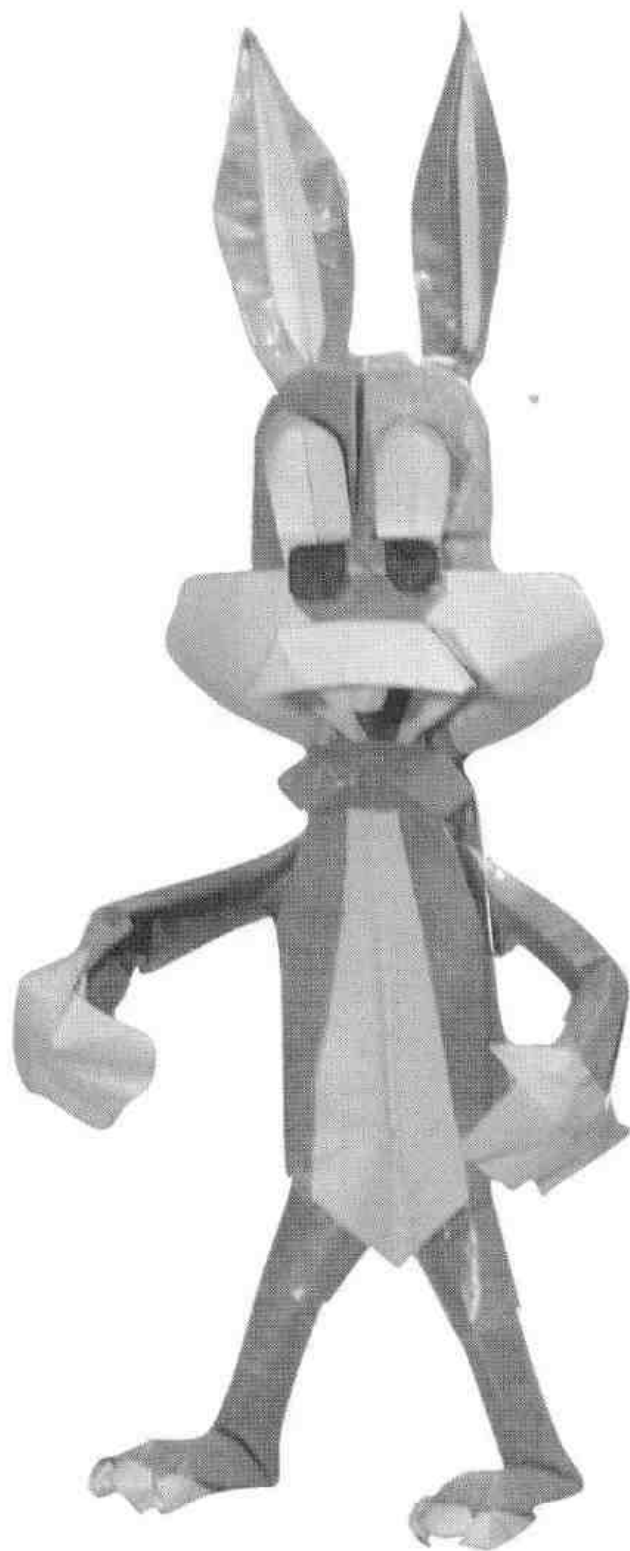

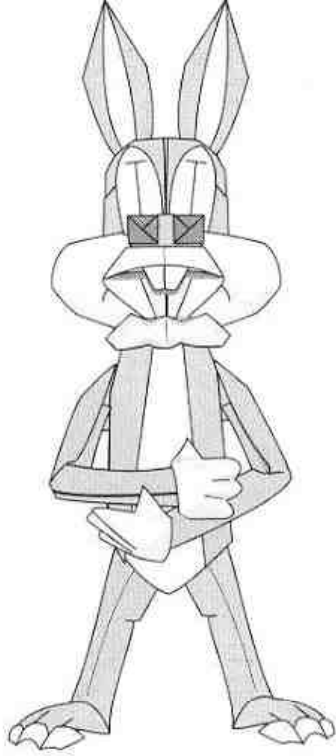

Utilizando las medidas recomendadas, se obtiene un modelo final de 17 cms.

Autor:	Halle
Nivel de dificultad:	Medio-Alto
Número de piezas:	10
Forma de las piezas:	Cuadrados

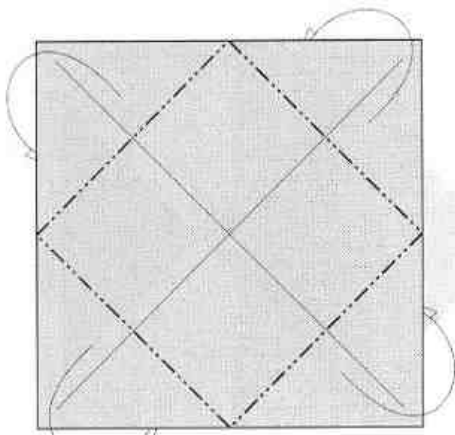

○ Gris
○ Blanco

■ 25 cm
■ 25 cm

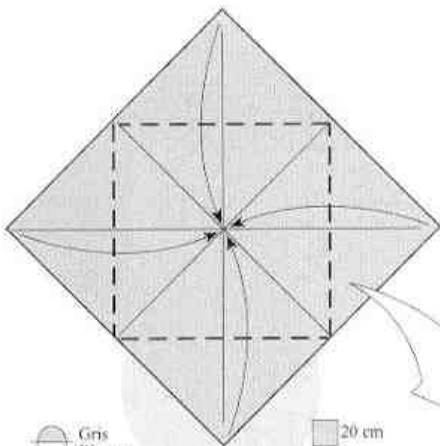
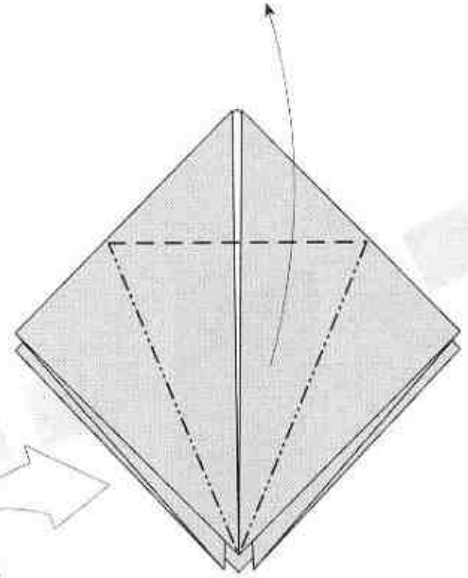
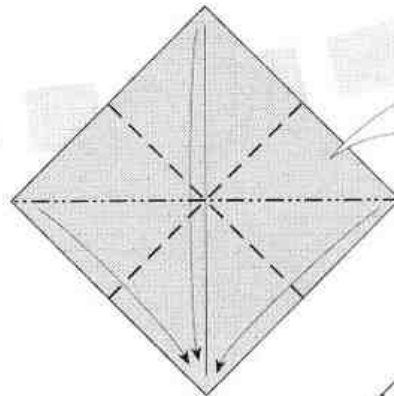

○ Gris
○ Blanco

■ 20 cm
■ 20 cm

45°

○ Gris

■ 12,5 cm
■ 12,5 cm

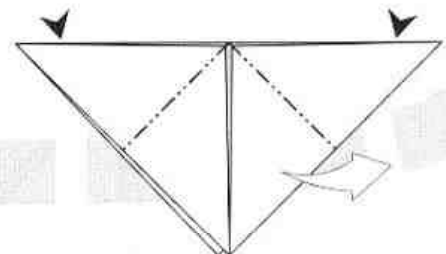
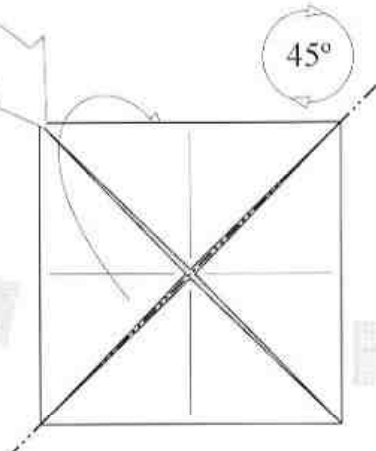

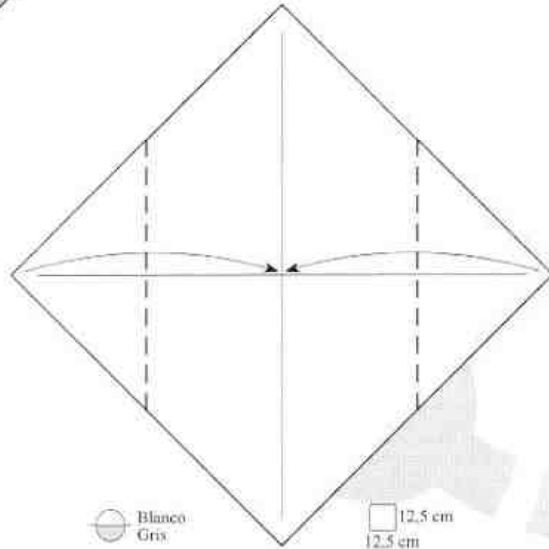
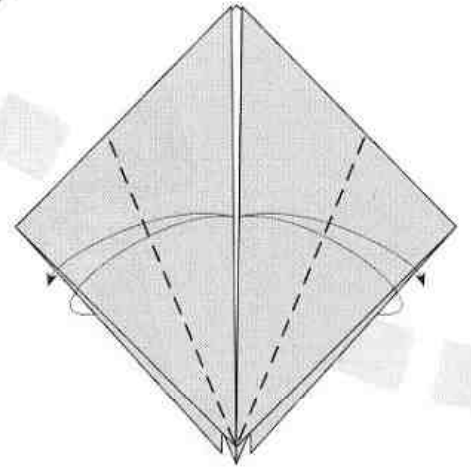
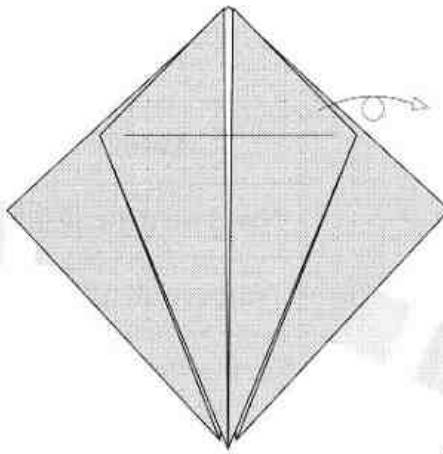
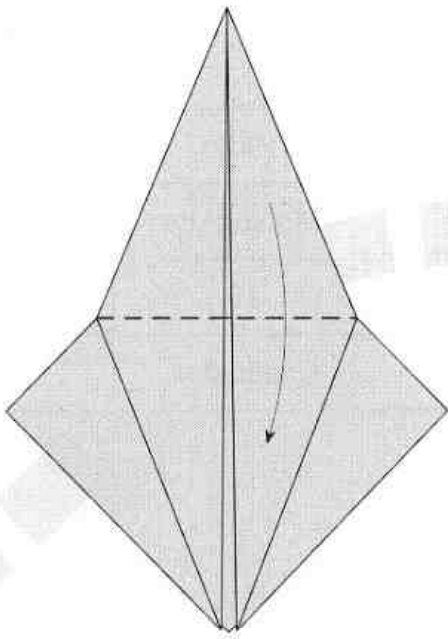

○ Blanco
○ Gris

□ 12,5 cm
□ 12,5 cm

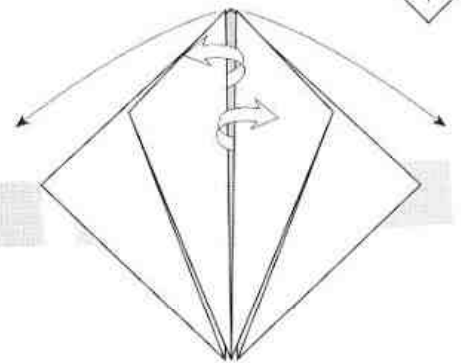
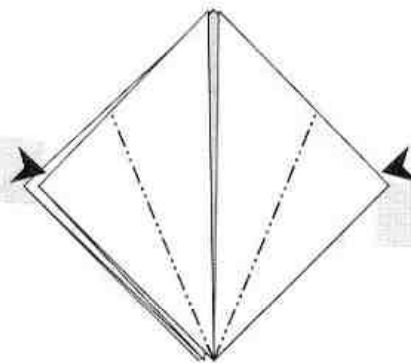
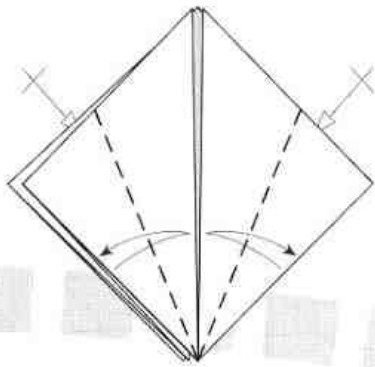
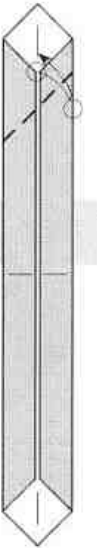
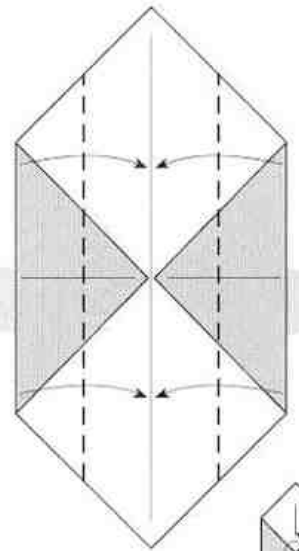
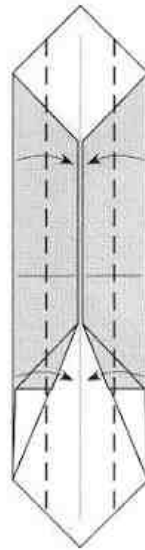
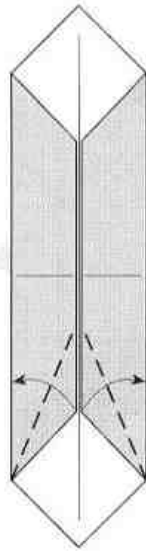
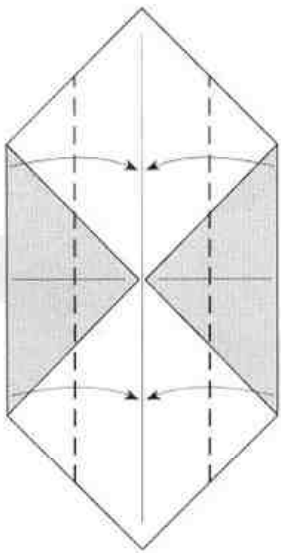

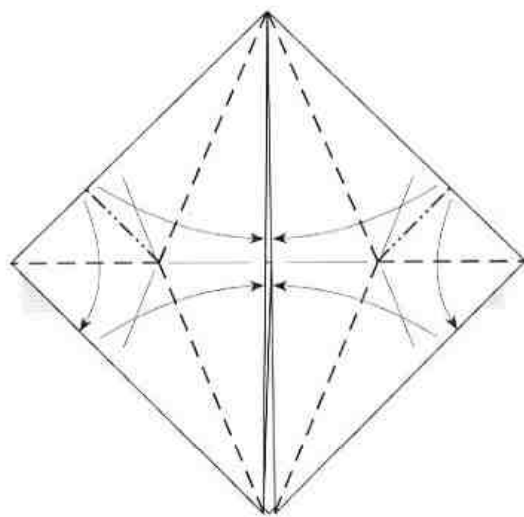
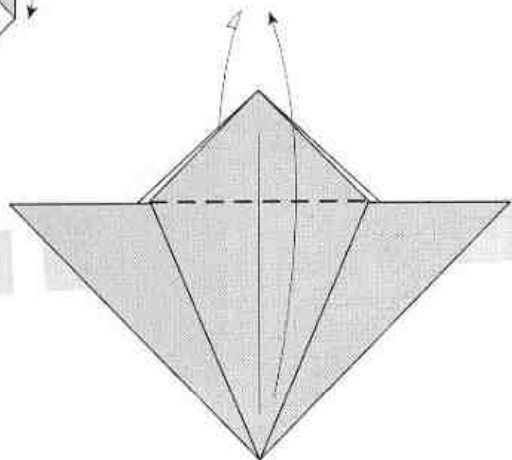
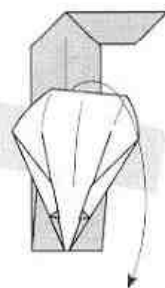
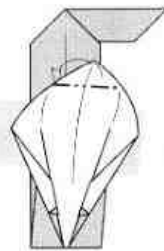
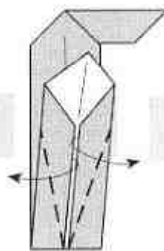
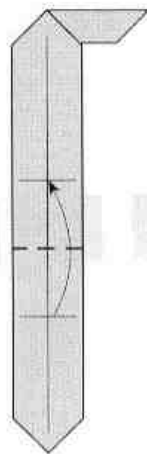
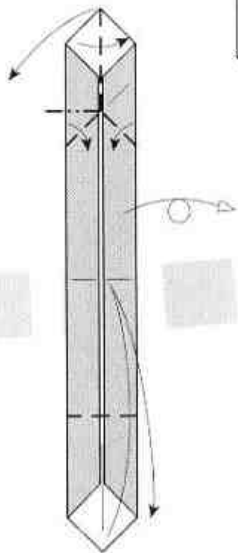
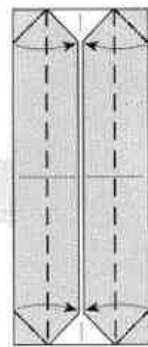
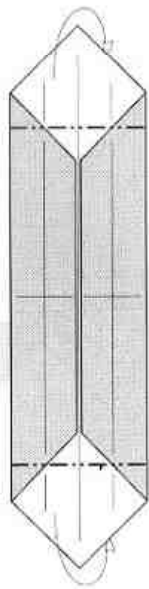
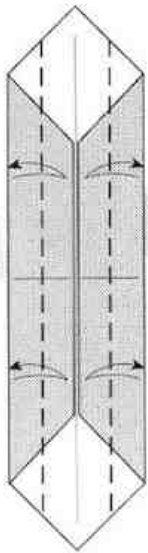
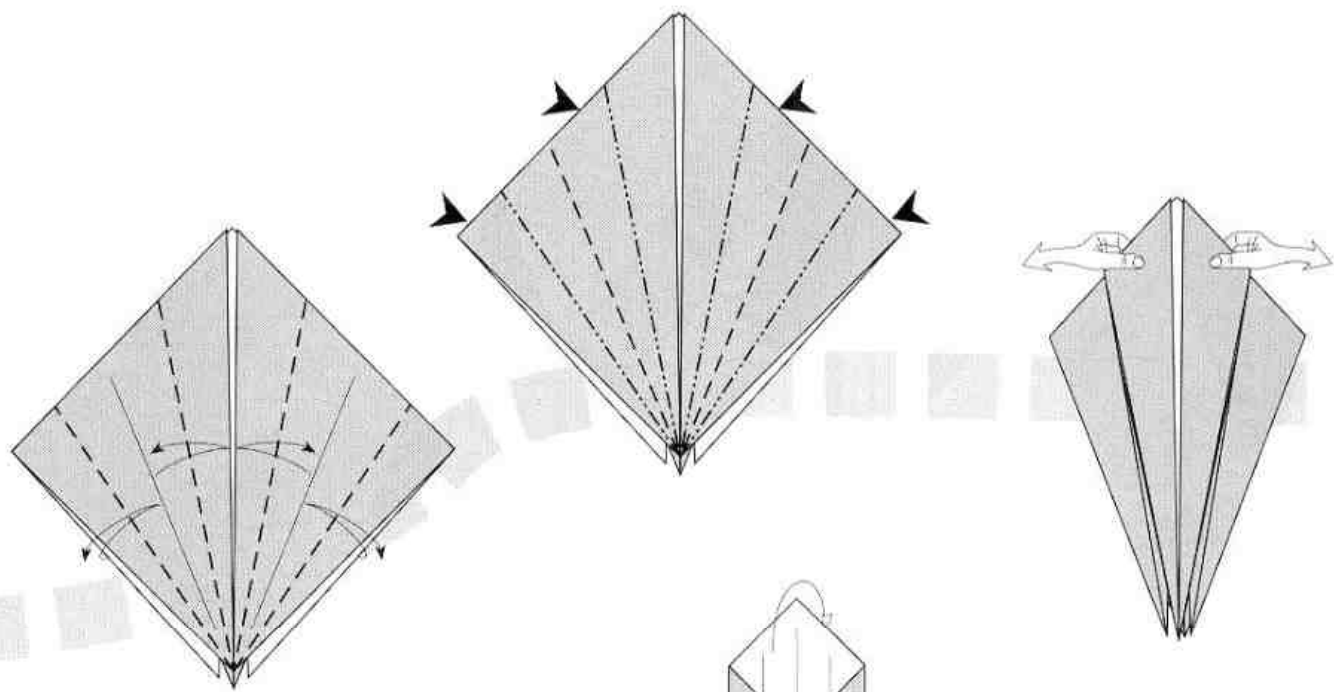

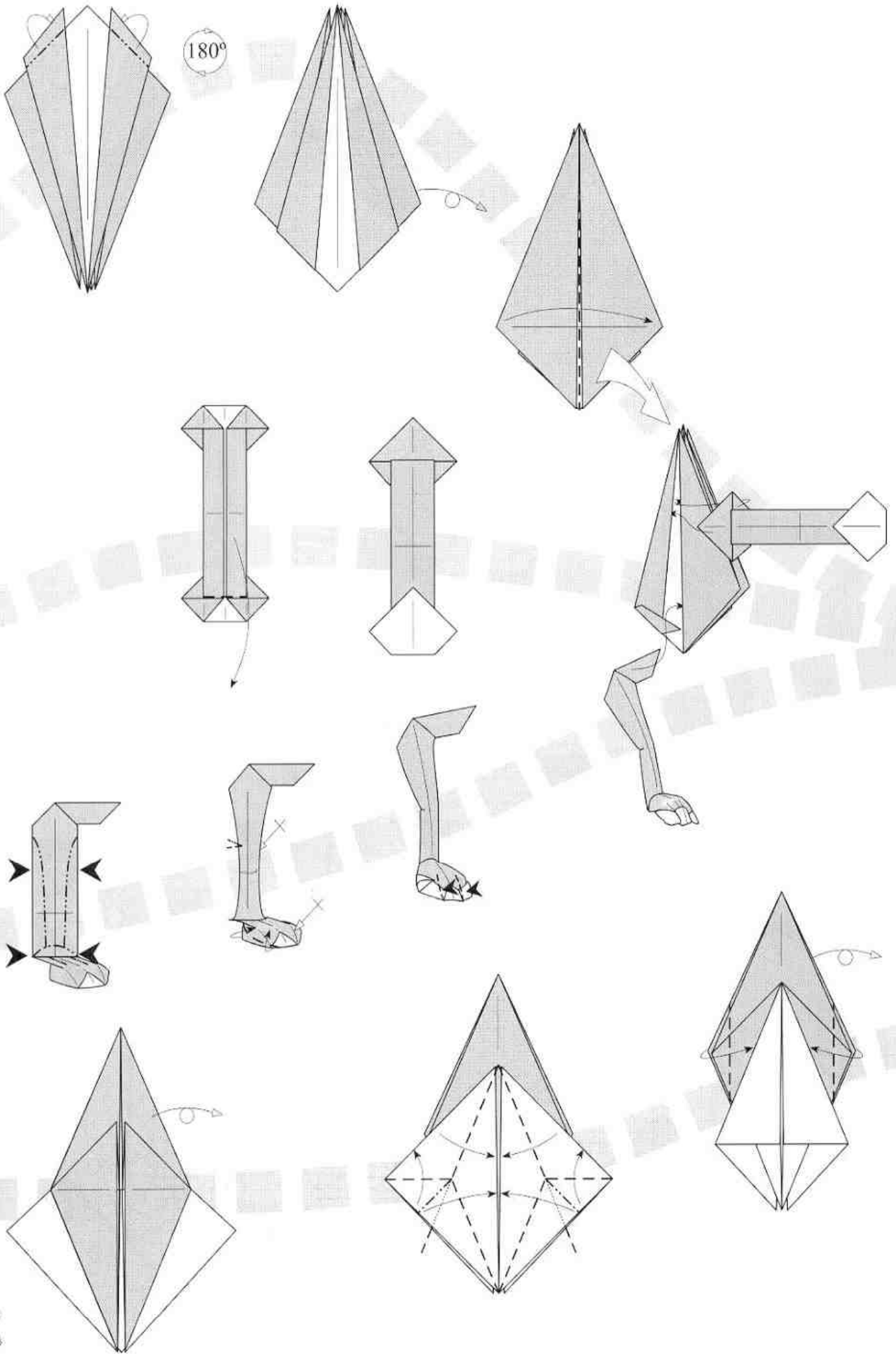

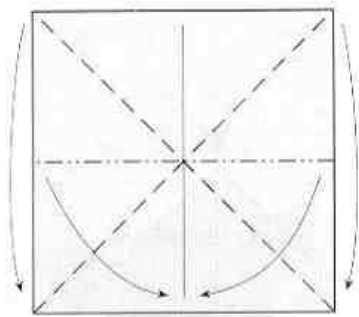

Blanco

5 cm
5 cm

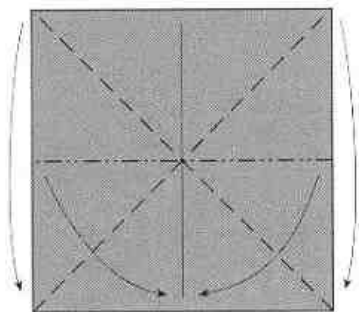
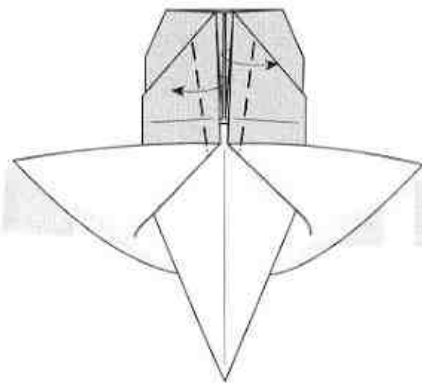
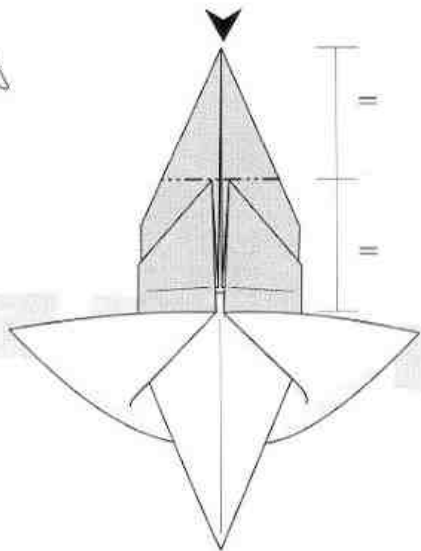
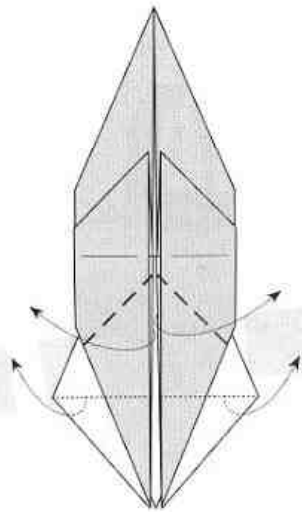
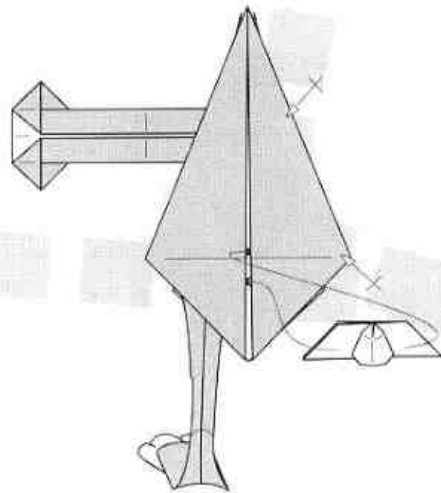
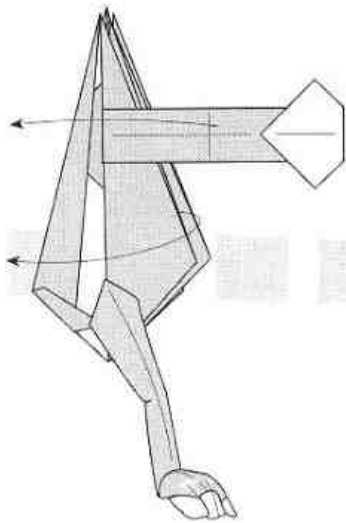
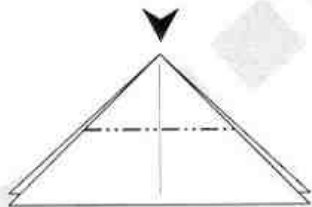
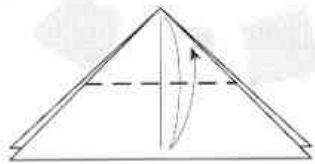

Azul
Gris

5 cm
5 cm

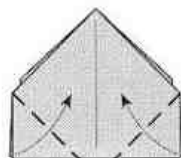
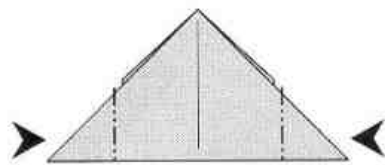
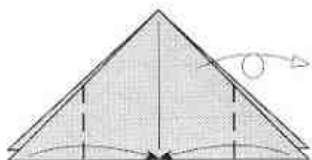

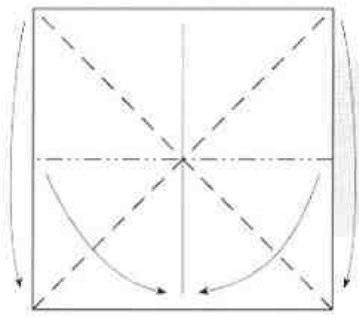

Rojo

5 cm

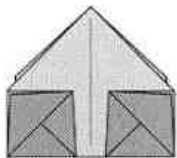
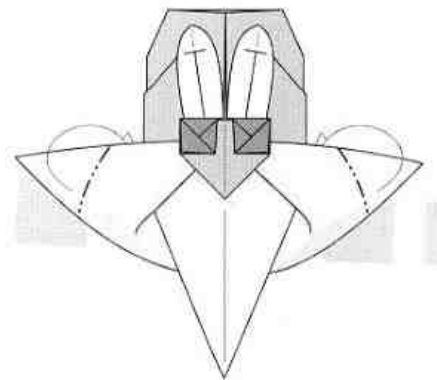
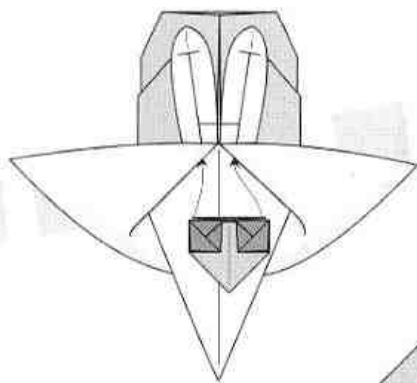
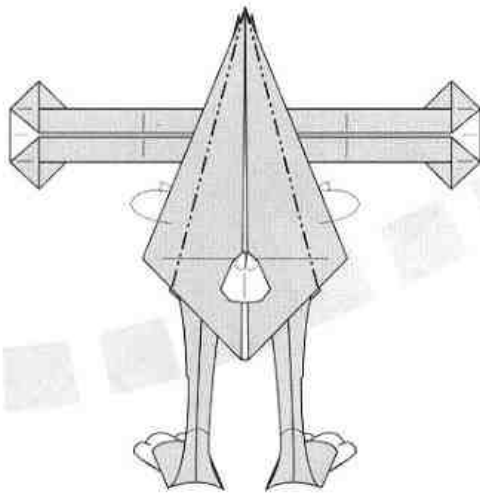
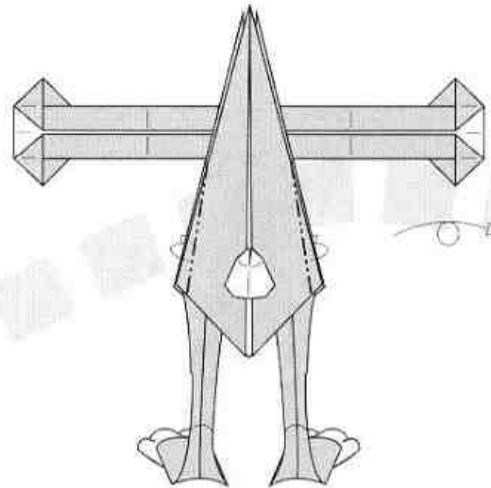
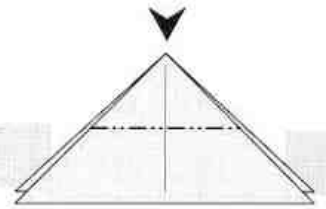
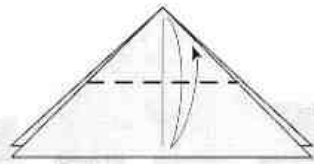

180°

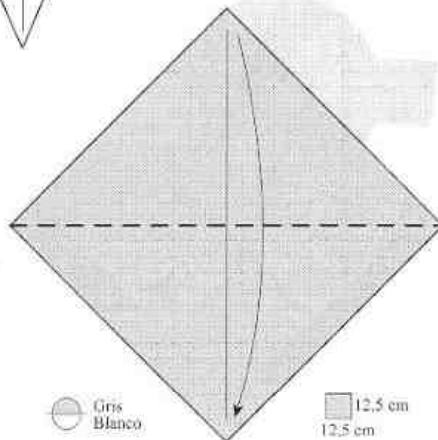
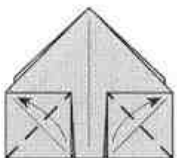

Gris
Blanco

12.5 cm

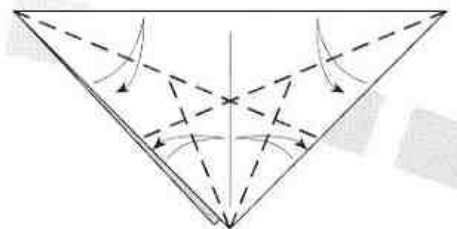

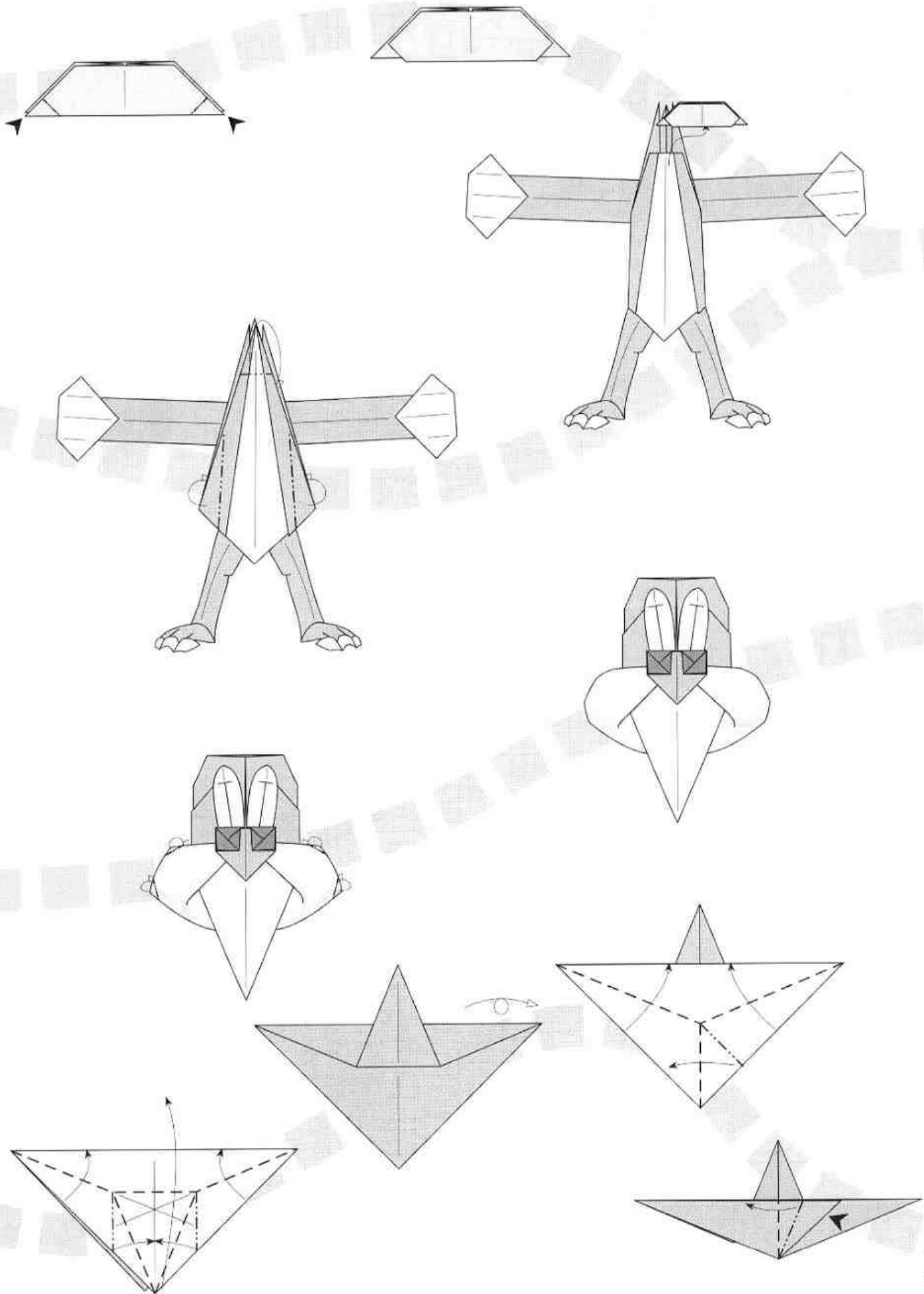

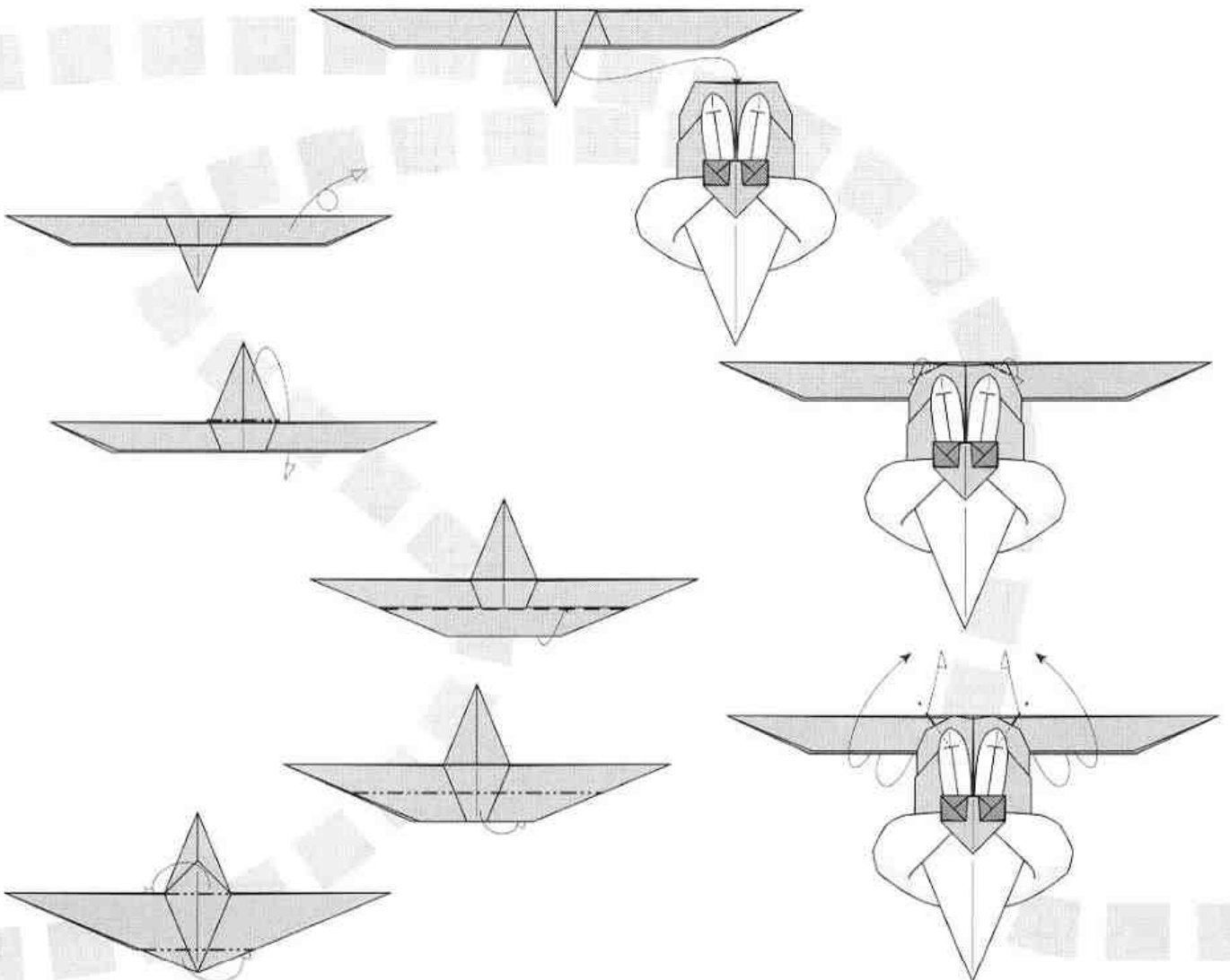
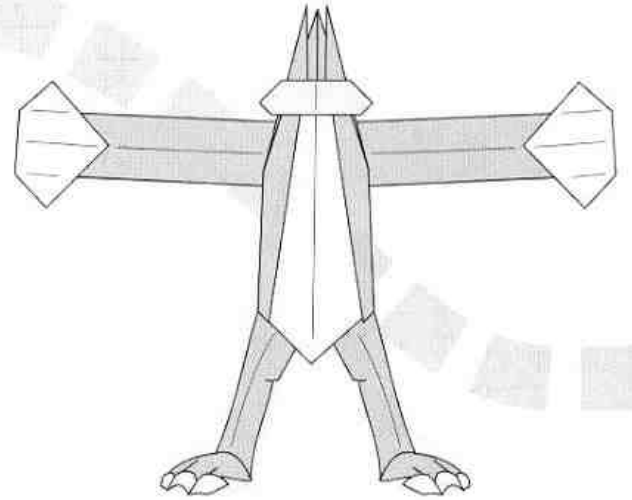
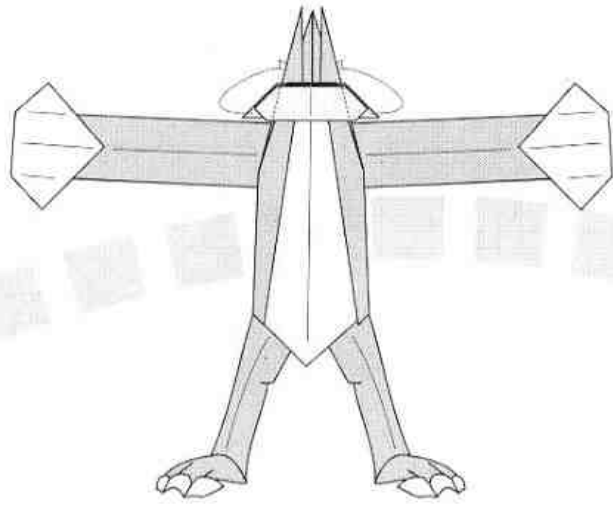

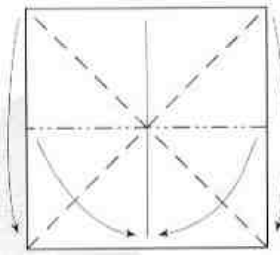
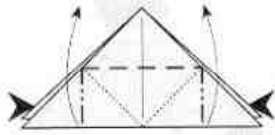
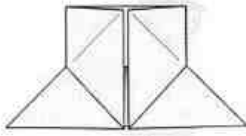
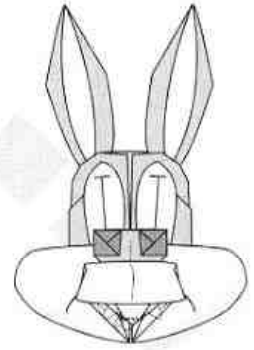
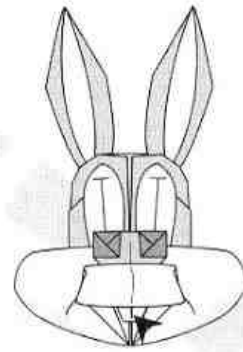
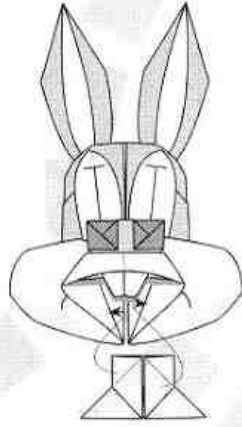
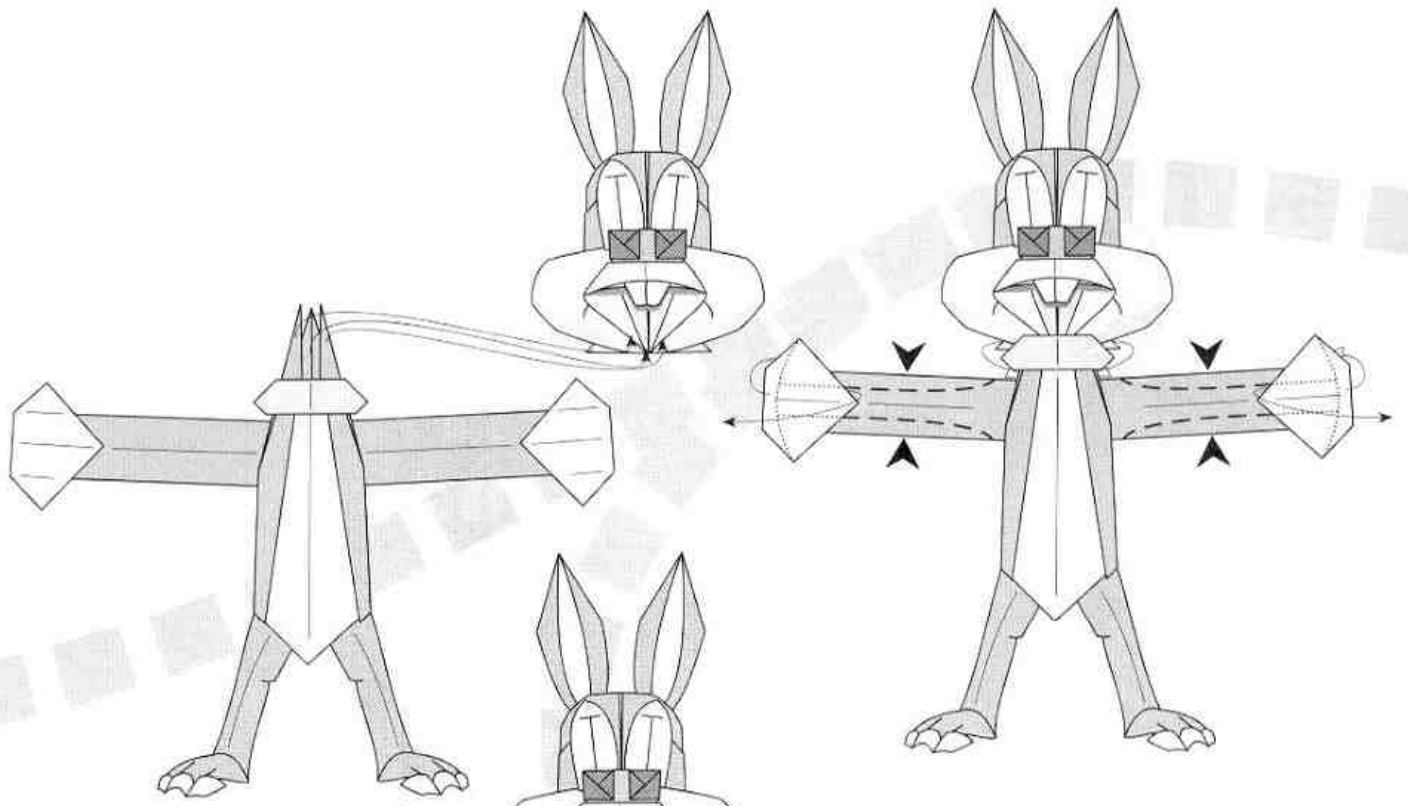

⊕ Rojo

5 cm
5 cm

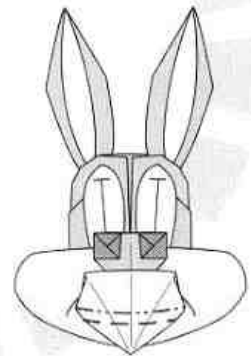
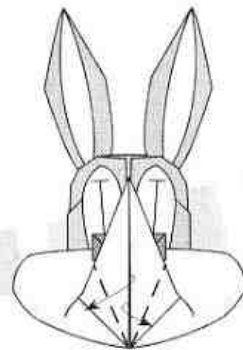
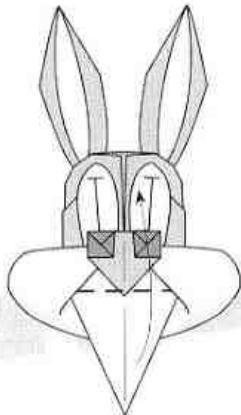
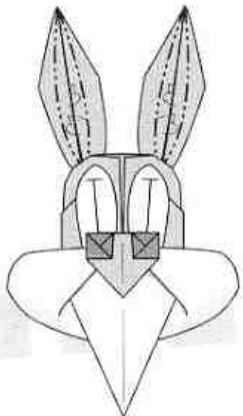

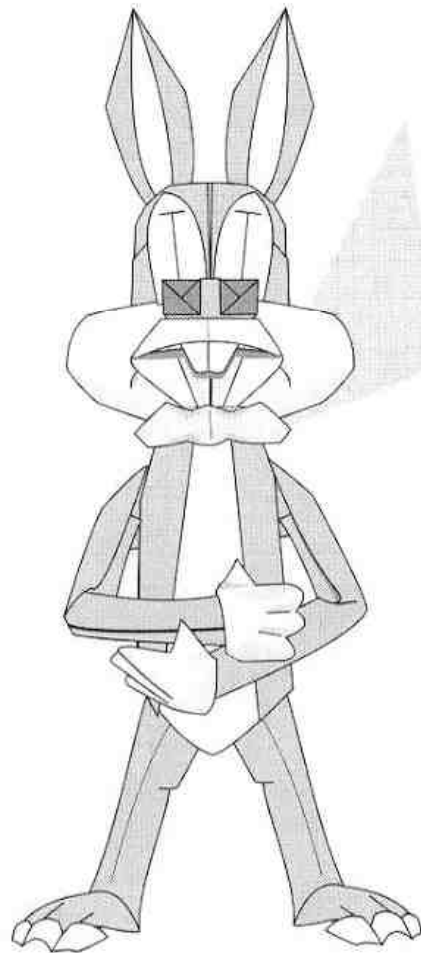
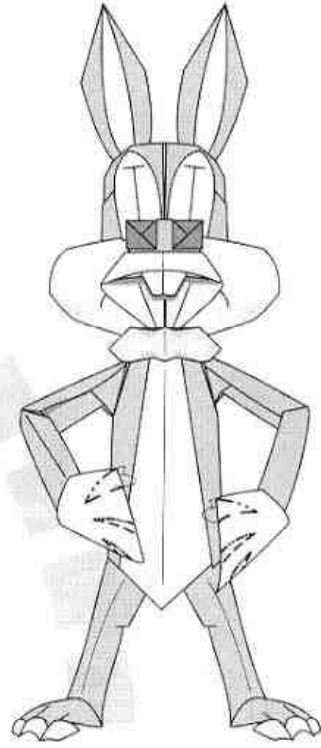
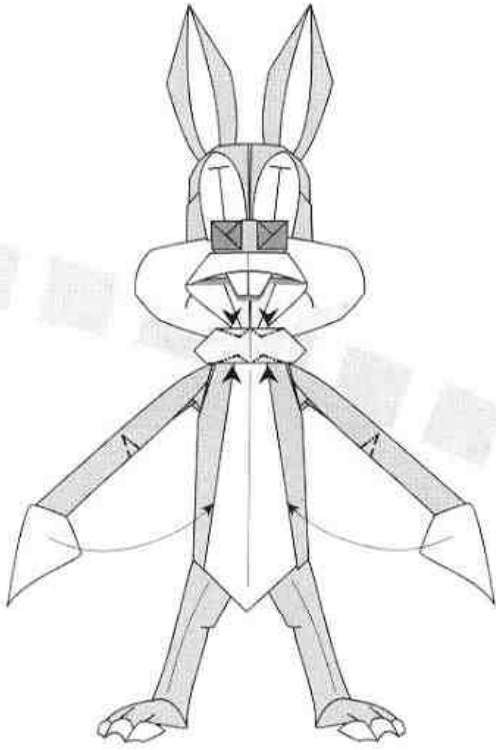

ASOCIACIONES DE PAPIROFLEXIA

ASOCIACION ESPAÑOLA de PAPIROFLEXIA

Apartado de correos: 13156
28080 MADRID
ESPAÑA

INTERNATIONAL ORIGAMI CENTER BELGIUM

I.O.C.B. V2W Fr.V.d. Berghelaan 171
2630 Aartselaar
BÉLGICA

ORIGAMI DEUTSCHLAND

Postfach 1630 – D
85316 FREISING
ALEMANIA

VLAAMS-NEDERLANDSE ORIGAMI STICHTING

Postbus 62
2370 ARENDONK
BÉLGICA

ORIGAMI MÜNCHEN

P.O. Box 221324 – D
80503 MÜNCHEN
ALEMANIA

ASOCIACIÓN DE ORIGAMI BOLIVIANO-JAPONÉS

Casilla 36800
LA PAZ
BOLIVIA

ORIGAMISTAS ARGENTINOS

c/o María Susana Tanaka de Arhasiro
Gorostiaga 1588
1426 BUENOS AIRES
ARGENTINA

ALIANÇA CULTURAL BRASIL-JAPÃO

R. Vergueiro, 727
1º andar - SAO PAULO SP
BRASIL CEP 01504-001

AUSTRALIAN ORIGAMI SOCIETY

2/5 Broome Street
Highgate Perth
AUSTRALIA 6000

MARISA FILION

966, de la Rivière
SAINTE-FOY QC
CANADA G1X 4L7

ORIGAMI AUSTRALIA

73 Harold Street
Mount Lawley
WESTERN AUSTRALIA 6050
AUSTRALIA

THE JAPANESE PAPER PLACE

887 Queen Street West
Toronto, M6J 1G5
Ontario
CANADA

CHINESE (H. K.) ORIGAMI SOCIETY

Flat A, 9/F
524 Nathan Rd.
KLN, HONG KONG
CHINA

ASOCIACIÓN COLOMBIANA DE ORIGAMI

Calle 146 A n° 9545
BOGOTÁ
COLOMBIA

ASOCIACIÓN VALLEUCANA DE ORIGAMISTAS

José Tomás Buitrago Molina
Calle 57 26-45 apto 105
Palmira Valle
COLOMBIA SA

KJJA D. H.

Chung - 3/4 Sukma Building
1-89 Dong Soong-Dong
Jogno-Ku Seoul 110-510
COREA

ASOCIACIÓN COSTARICENSE DE ORIGAMI

Apartado 167
10014 SAN JOSÉ
COSTA RICA

DANSK ORIGAMI CENTER

Thoki Yenn
Ideas Un-Limited
Tranehavegard, 1, D. 101
2450 - Kobenhavn SV
DINAMARCA

BAY AREA RAPID FOLDERS (BARF)

Jeremy Shafer
1744 Virginia St.
Berkeley, CA 94703
ESTADOS UNIDOS

ORIGAMI USA

15 West 77th St.
NEW YORK CITY
NY 10024-5192
ESTADOS UNIDOS

WEST COAST ORIGAMI GUILD

c/o terry Hall 2628
29th Street
Santa Mónica, CA. 90405
ESTADOS UNIDOS

MOUVEMENT FRANÇAIS DES PLIEURS DE PAPIER

56 rue Coriolis
75012 París
FRANCIA

DE VUYST ORIGAMI

Postbus 427
5460 AK Veghel
HOLANDA

ORIGAMI SOCIËTËIT NEDERLAND

1e Sweelinckstraat 9
2517 GA
DEN HAAG
HOLANDA

HUNGARIAN ORIGAMI SOCIETY

Kecskemét pf. 60
H-6000 HUNGRÍA

MAGYAR ORIGAMI KÖR

H 6001, Kecskemét
Pf. 488
HUNGRÍA

ALAPANI

76 M.C. Ghosh Lane
Howrh - 711 101
West Bengal
INDIA

ORIGAMI SOCIETY OF CALCUTA

5/9/1 Khanpur Road
CALCUTA 700047
INDIA



ISRAEL ORIGAMI SOCIETY

c/o Rosaly Yevnin
Mevo HaAsara 1/22
97876 JERUSALEN
ISRAEL

**THE ISRAELI ORIGAMI
CENTER LTD.**

P.O. Box 23907
TEL AVIV 61231
ISRAEL

CENTRO DIFUSSIONE ORIGAMI

Caselle Postale 42
21040 CARONNO VARESINO (VA)
ITALIA

CENTRO ITALIANO DE ORIGAMI

Caselle Postale 357
10100 TORINO
ITALIA

ORIGAMI

c/o Paolo Meschi
Via de Tofori 67
55010 Tofori
LUCCA
ITALIA

**INTERNATIONAL
ORIGAMI CENTRE**

P. O. Box 3 Ogikubo
TOKYO 167
JAPÓN

**ORIGAMI INTERNATIONAL
JAPAN**

Yoshihide Momotani 5 of 30 Noda 3
Chome Kuzua
Hirakata City
OSAKA 573
JAPÓN

ORIGAMI TANTEIDAN

Mr. Makoto Yamaguchi
112 Matsuedaiuhi Bldg 2^a 5
36-7 Hakusan
Bunkyoku-ku
TOKIO
JAPÓN

NIPPON ORIGAMI ASSOCIATION

1-096 Domir Gobancho 12
Gobancho Chiyodaku
TOKYO 102
JAPÓN

TOKYO ORIGAMI ASSOCIATION

5-4-2-103 Toyo Kotoku
TOKYO
JAPÓN

**FEDERACIÓN INTERNACIONAL
DE ORIGAMI DE MÉXICO A. C.**

Providencia 520 Col. Del Valle
MÉXICO, D. F. C. P. 03100
MÉXICO

NEW ZELAND ORIGAMI SOCIETY

79 Dunbar Road
CHRISTCHURCH 3
NUEVA ZELANDA

CENTRO LATINO DE ORIGAMI

Caracas 2655
Dpto. 13 - Jesús María
LIMA 11
PERÚ

POLSKIE CENTRUM ORIGAMI

Szkoza Podstanowa nr 20
Os. Rzeczypospolite 44
Poznan 775631
POLONIA

BRITISH ORIGAMI SOCIETY

11 Yarningale Road
Kings Heath BIRMINGHAM
B14 6LY - REINO UNIDO

ST. PETERSBOURG ORIGAMI CENTRE

Sergei Afonkin
Av. Rubinshteina 13
ST. PETERSBOURG 191002
RUSIA



TATIANA KHLIAMOVA

Sireneviy bulbar, dom 8, korpus 1, kv. 294
194352 ST. PETERSBOURG
RUSIA

**THE UNION OF SOVIET SOCIETIES
FOR FRIENDSHIP & CULTURAL
RELATIONS**

Noskva K - 9 Prospekt
Kalina 14
RUSIA

ORIGAMI SVERIGE

c/o Dino Andreozzi
Tre Källors Väg 17 NB
145 65 NORSBORG
SUECIA

**ASOCIACION DE ORIGAMI DE
VENEZUELA**

Av. Circunvalación nº 188
Las Mariase - El Hatillo
EDO - Miranda
VENEZUELA



Y MUY
PRONTO...

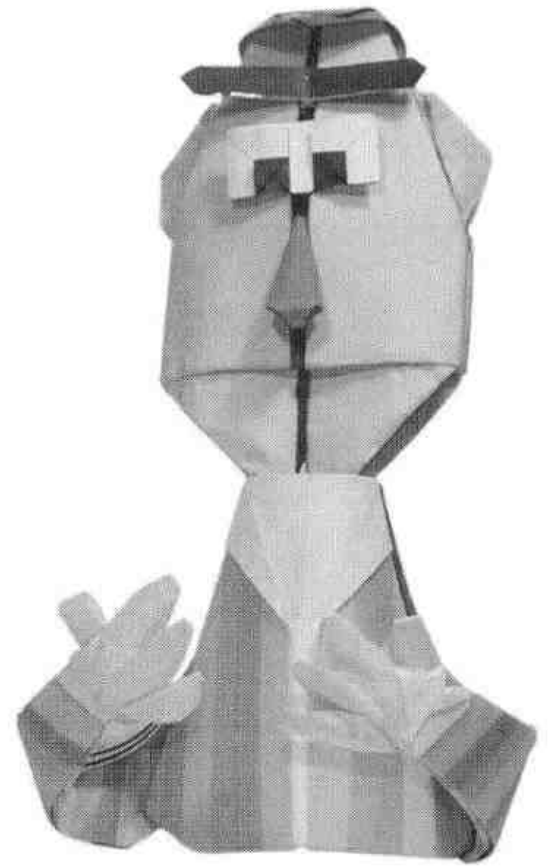
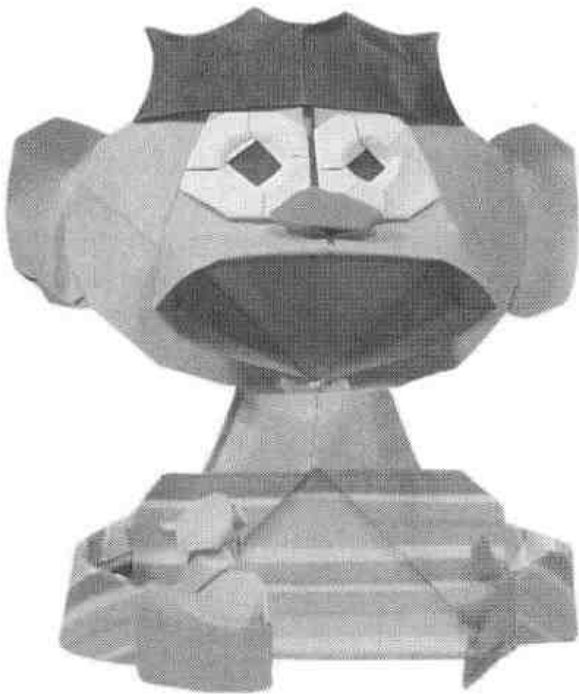
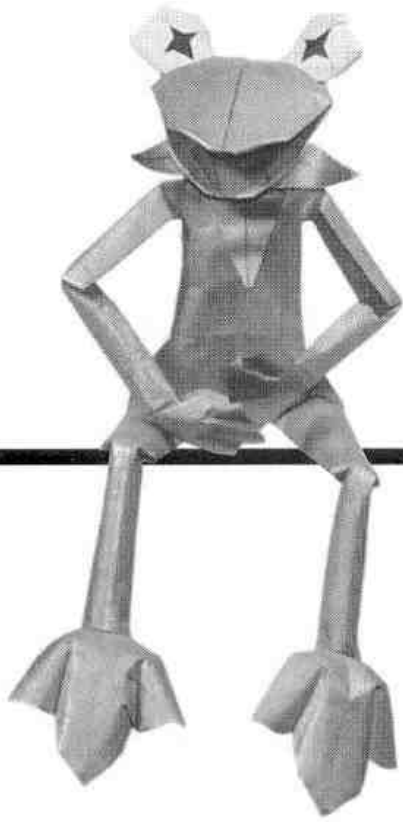

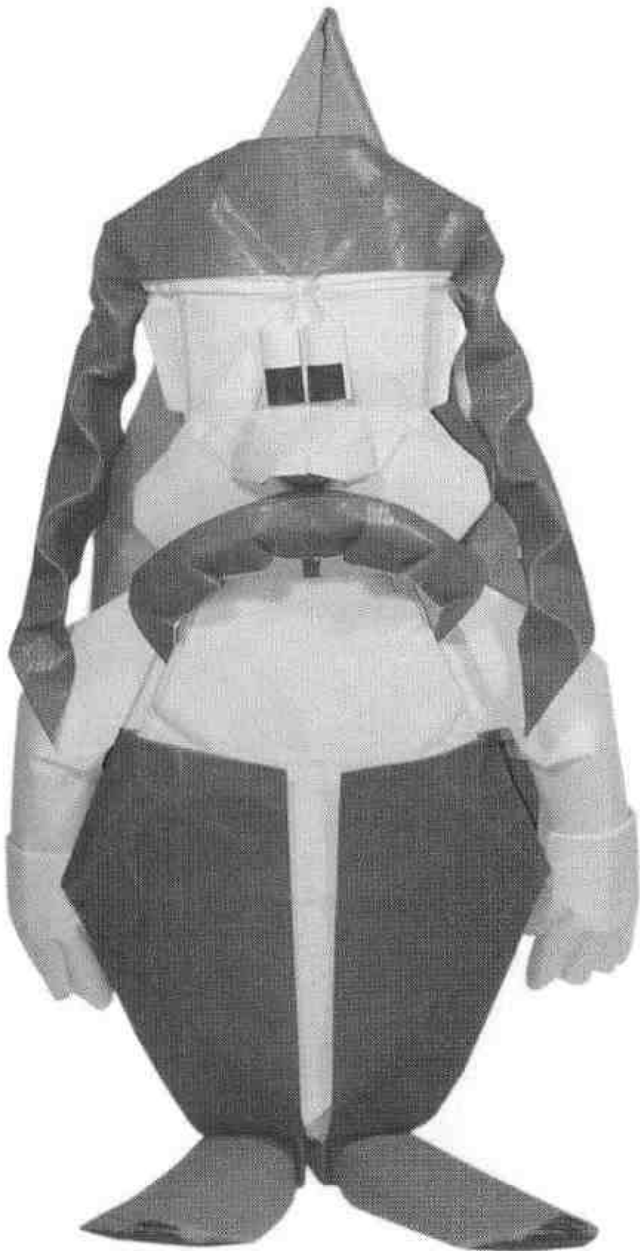
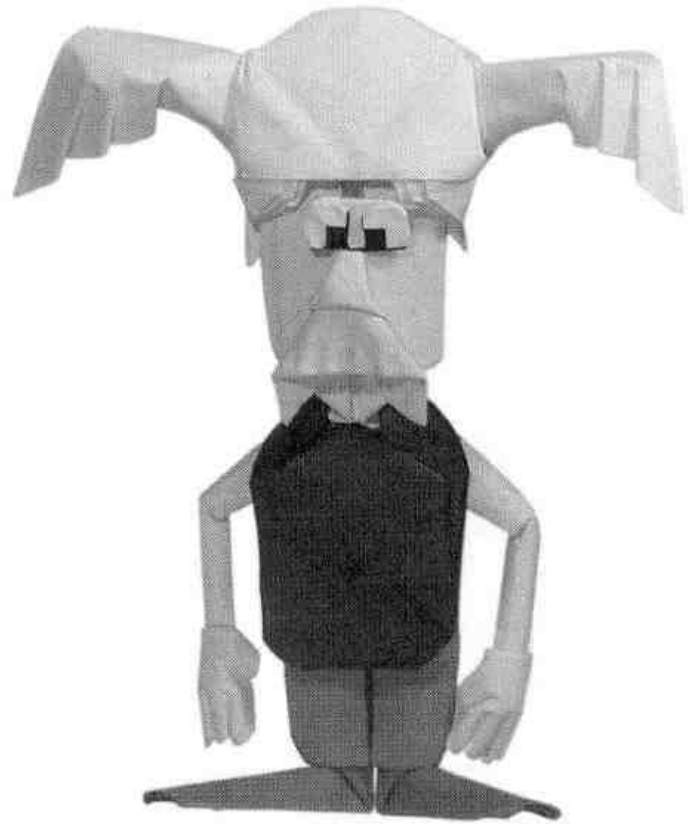

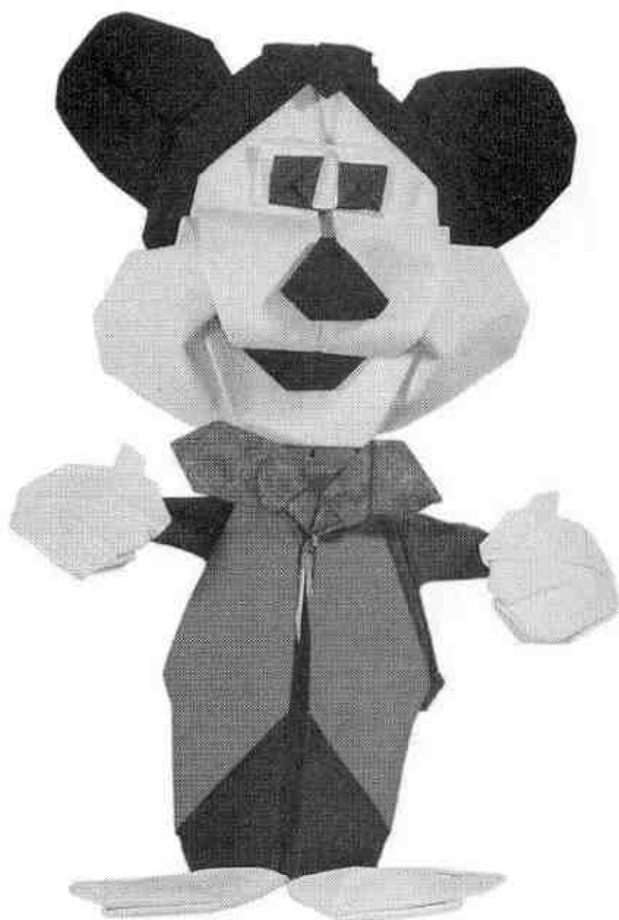
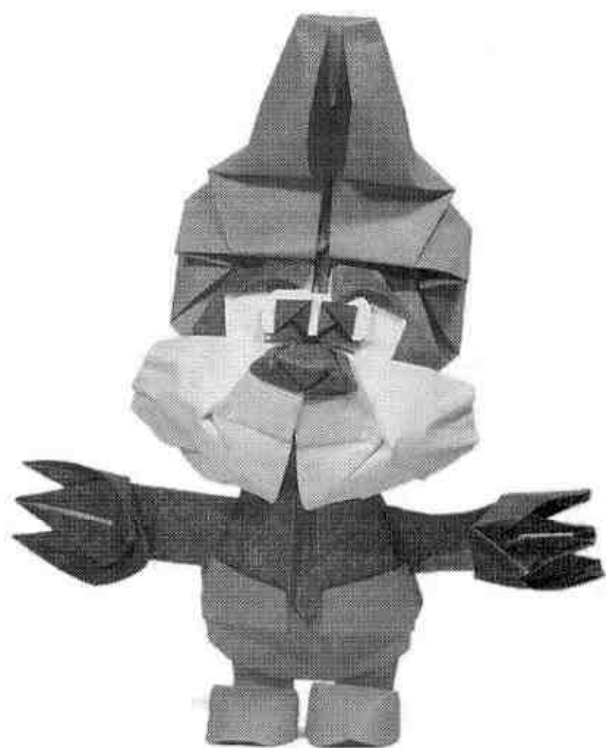
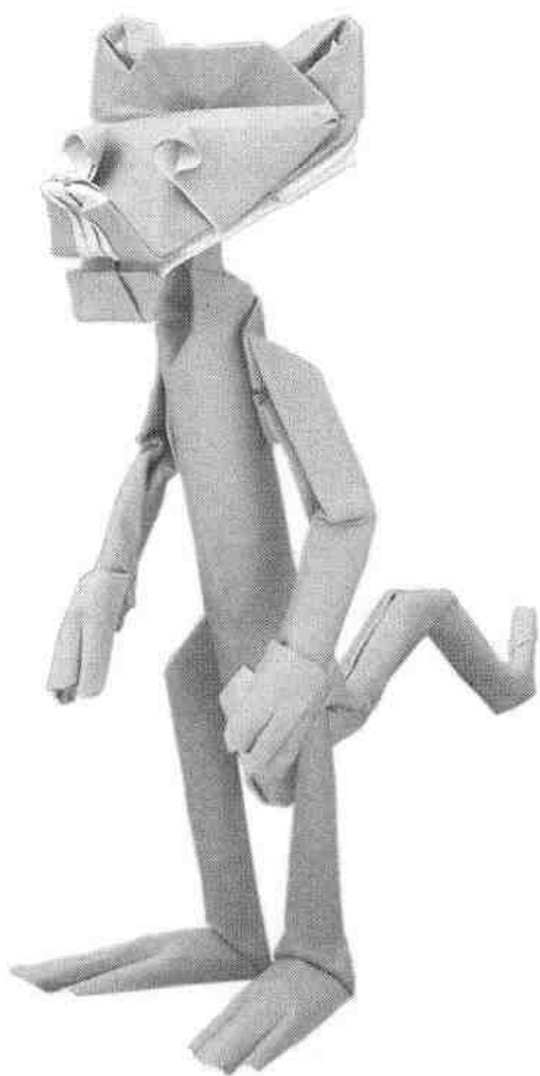

*iii Hasta Cartoon
Origami 2. amigos!!!*

