

The 13th KOREA ORIGAMI CONVENTION Diagrams Collection 2023



© Yoo TaeYong



사단법인 한국종이접기협회
KOREA ORIGAMI ASSOCIATION

Table of Contents



Tit 06~08

Inflatable little bird 09~11

Arapaima 12~18

사자 (Lion) 19~21

Wild buffalo 22~24

나무늘보 (Sloth) 25~35

호랑이 얼굴 (Tiger mask) 36~40

Asian tapir 41

앉아있는 고양이 (Sitting Cat) 42~46

펭귄 (Penguin) 47~53

Hatching Dragon 54~58

비행하는 용 (Flapping Dragon) 59~65

Little Dragon 66~73

The West Dragon 74~77

용2021 (Dragon2021) 78~84

산타 클로스 (Santa claus) 85~87

상자 안에 남자 (Man in the box) 88~91

신랑 신부 (Groom bride) 92~94

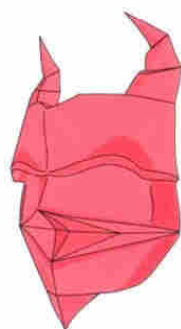
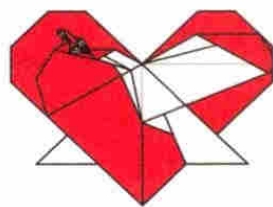

When devil speaks 95~99

새싹 (Sprout) 100~103

장미 (Rose) 104~106

악어입 (Crocodile Mouth) 107~109

VANILLA 99 110~113

뚜껑이 있는 삼각 쟁반 (Triangular Tray with Lid) 114~119

Iso-Area Flower 120~121

피젯스피너 (Fidget Spinner) 122~125

Peace and Love 126~129

퍼즐 (Puzzle) 130~131

F-22 랩터 (F-22 Raptor) 132~138

우유 (Milk) 139~142

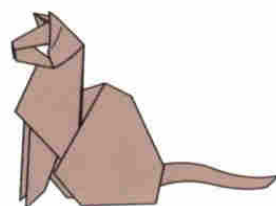

접기 기본 기호

★다음 기호에 의하여 접는 방법이 표시되므로 기본 기호와 약속을 꼭 기억하세요.



골짜기접기

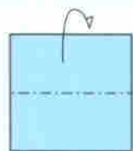

산접기



접었다 편 선 만들기

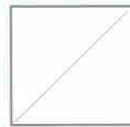

같은 방향으로 계속 접기

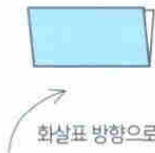

화살표 방향으로 접기



뒤로 접기

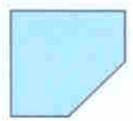
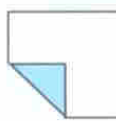
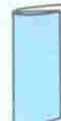
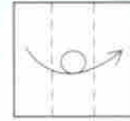

가상선 (또는 숨은 선) 접기 전의 선

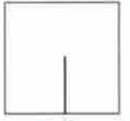

자르기

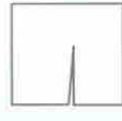

확대



돌려 놓는다.



축소



부풀린다.

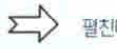

펼친다.



화살표 방향으로 끼우거나 잡아 뻐다.



밀어 넣는다.

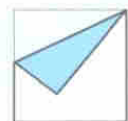

계단접기

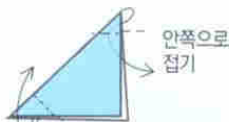

안쪽으로 접기

밖으로 뒤집어 접기

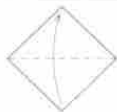
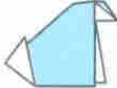

수심각접기 기본형



수심각접기 기본형



문집기 기본형



쌍곡선접기 기본형

고기접기 기본형

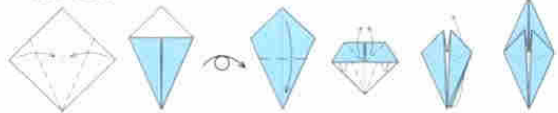

쌍배접기 기본형



삼각주머니접기 기본형

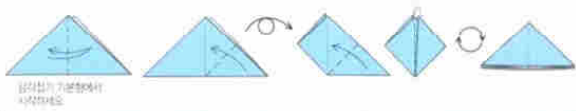

사각주머니접기 기본형

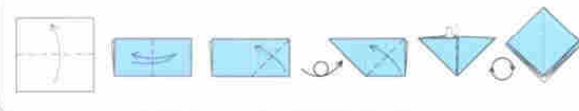

학접기 기본형

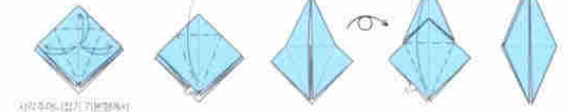

꽃접기 기본형

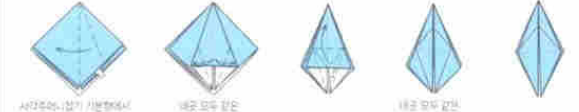



Tit



Inflatable little bird



Arapaima



사자 Lion



Wild buffalo



호랑이 얼굴 Tiger mask



Asian tapir



Hatching Dragon



앉아있는 고양이
Sitting Cat



펭귄
Penguin



비행하는 용
Flapping Dragon



The west Dragon



용2021 Dragon2021



나무늘보 Sloth



장미 Rose



뚜껑이 있는 삼각 쟁반
Triangular Tray with Lid



산타 클로스
Santa claus

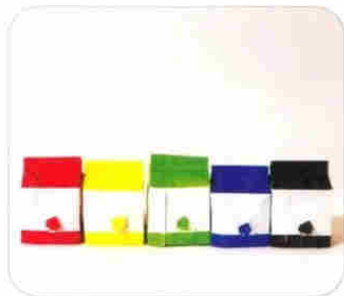

우유 Milk



상자 안에 남자
Man in the box



VANILLA 99



새싹 Sprout



피젯스피너
Fidget Spinner



Peace and Love



퍼즐 Puzzle



F-22 랩터 F-22 Raptor



신랑 신부 Groom bride

Tit

by Muneji Fuchimoto : Japan

Diagram by Muneji Fuchimoto

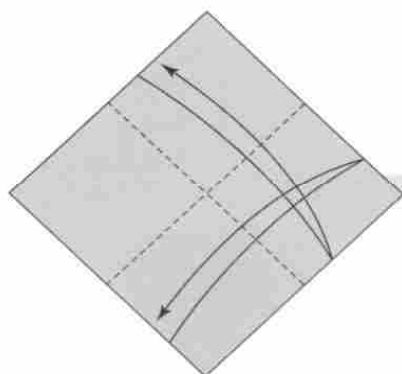
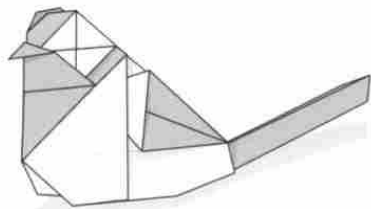

1 Make a Crease (valley fold and unfold)

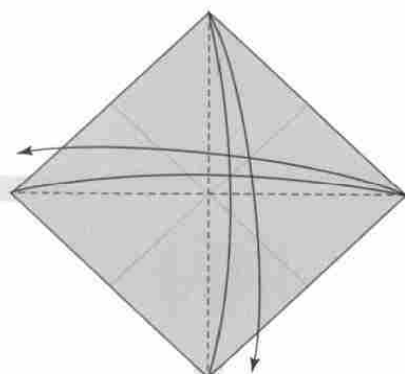

2 Make a Crease

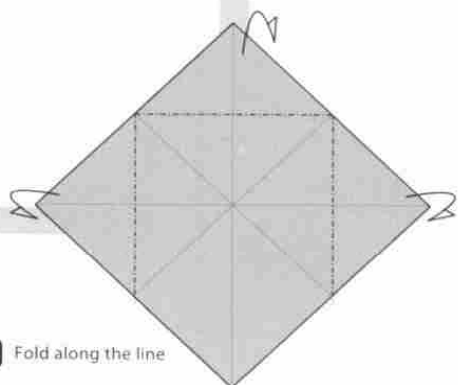

3 Fold along the line

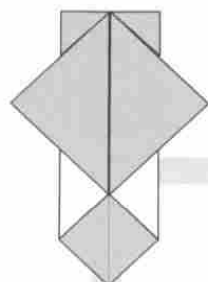

5 Turn over

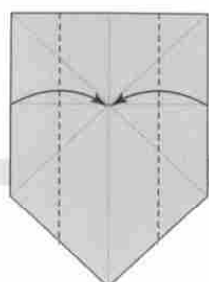

4 Fold along the line

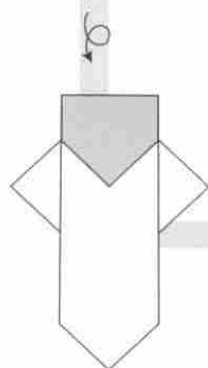

6

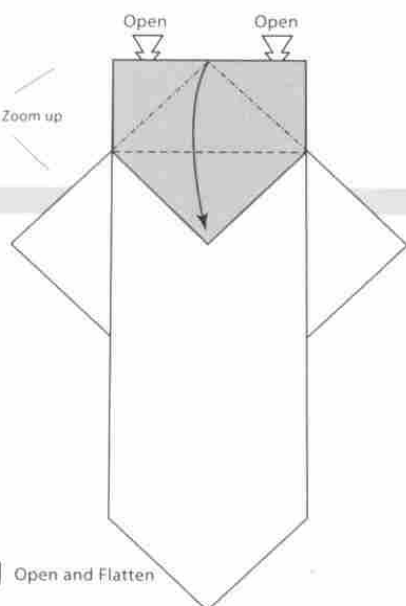

7 Open and Flatten

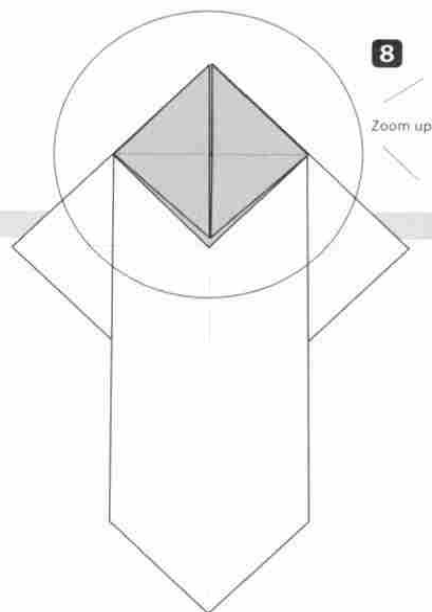

8

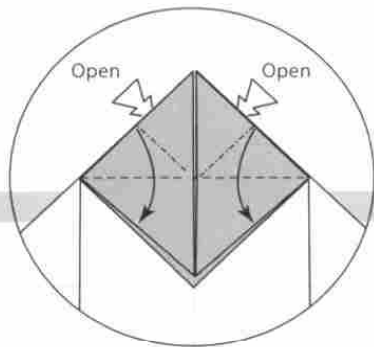

9 Open and Flatten

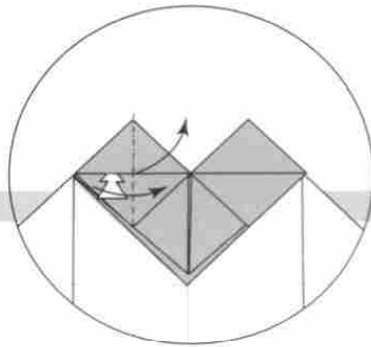

10 Open and Flatten

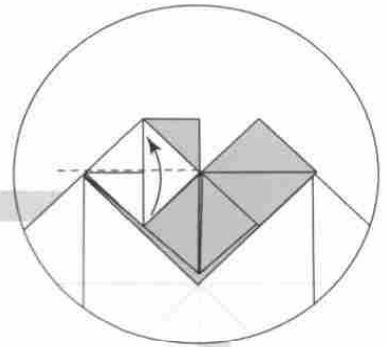

11 Fold along the line

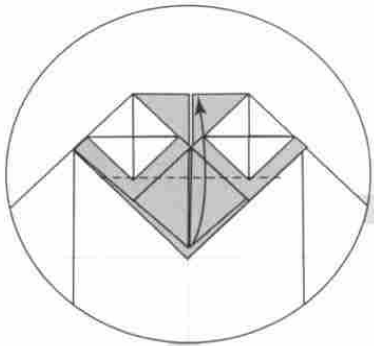

14 Fold along the line

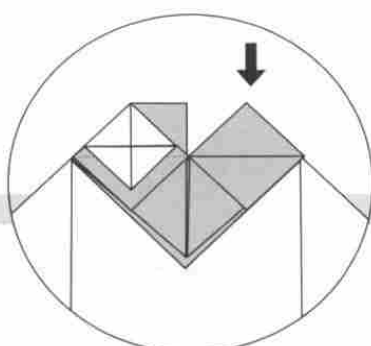

13 Repeat steps 10-12 on the right side.

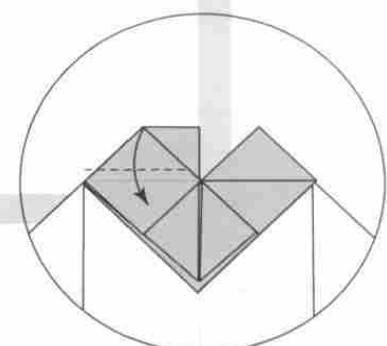

12 Fold along the line

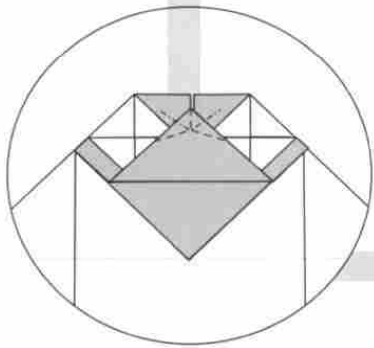

15 Rabbit-Ear Fold

Zoom out

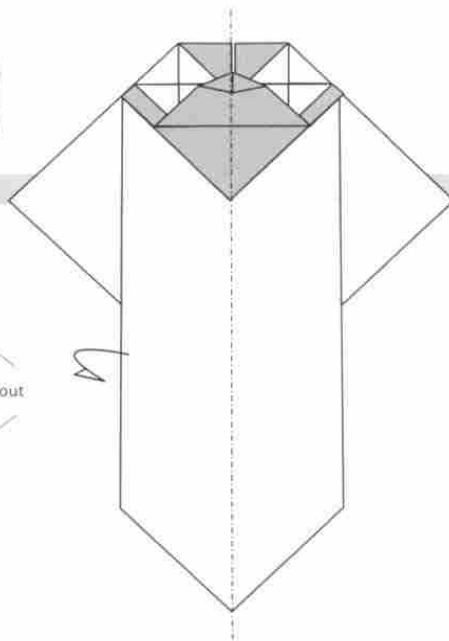

16 Fold in half the center

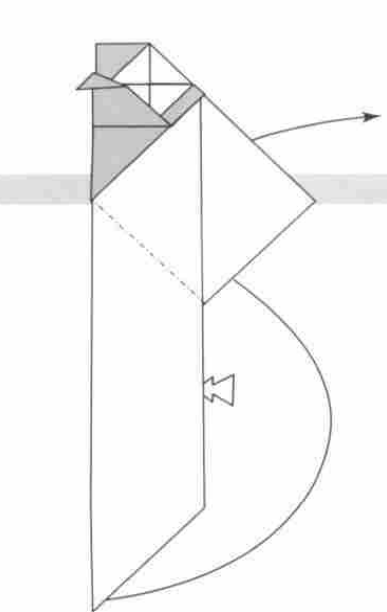

17 Inside Reverse Fold

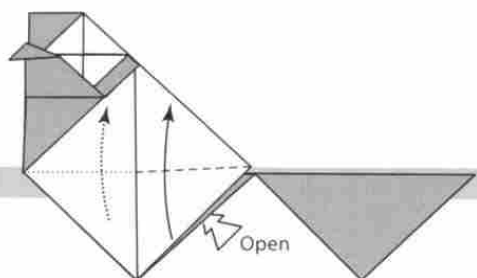

18 Fold along the line (do the other side too)

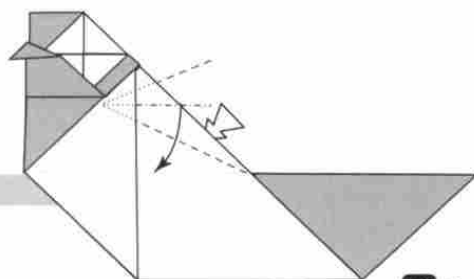

19 Open and Flatten (do the other side too)

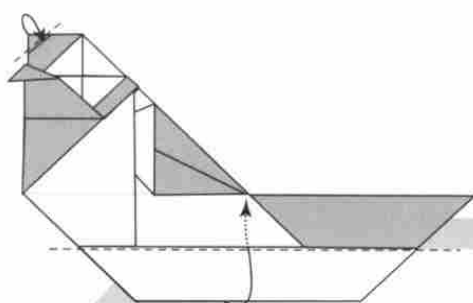

21 Fold forward and insert.

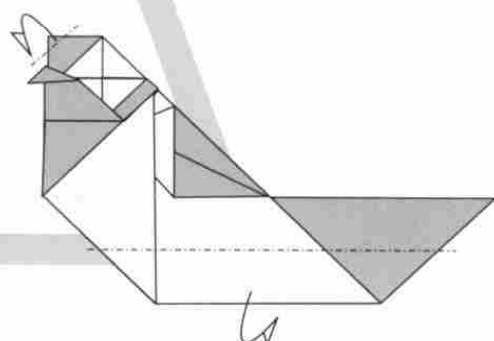

20 Fold in behind

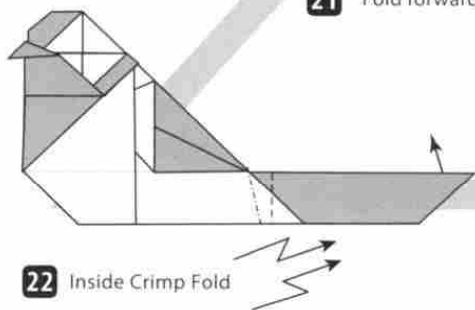

22 Inside Crimp Fold

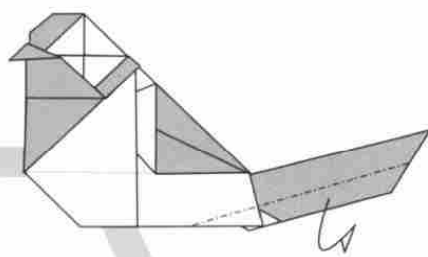

23 Fold in behind

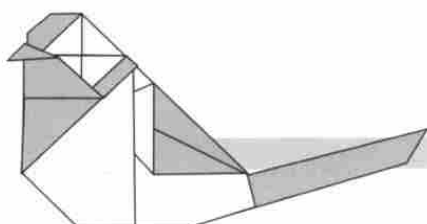

Complete

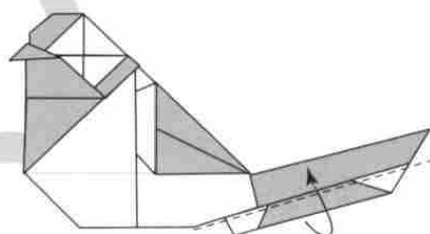

24 Fold forward and insert.

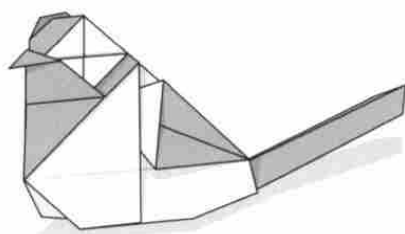

Pajarito inflable

“Inflatable little bird”

by Jacksiel Rivas : México

Diagram by Jacksiel Rivas

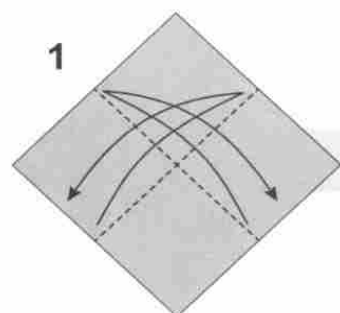
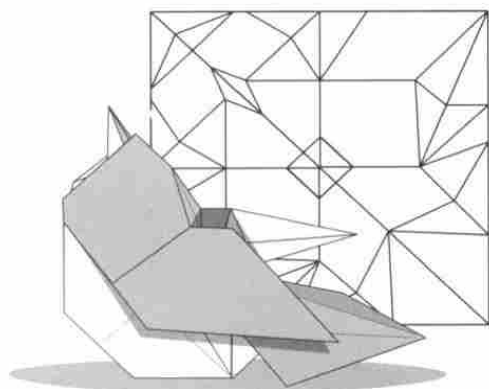

1
Plegar y desplegar los bordes.
“Fold and unfold the edges”

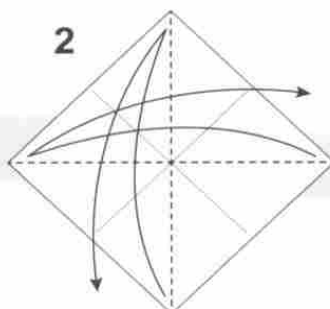

2
Plegar y desplegar las diagonales.
“Fold and unfold the diagonals”

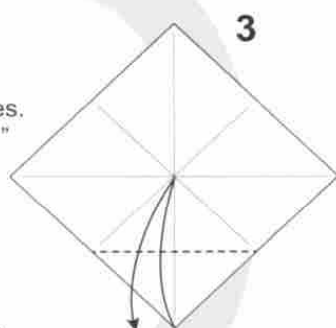

3
Plegar y desplegar.
“Fold and unfold”

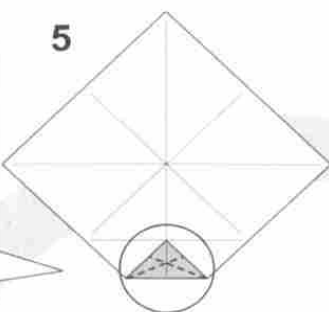
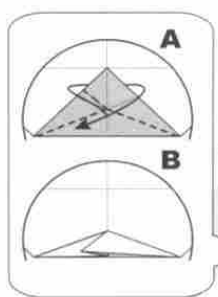

4
5
Plegar en oreja de conejo.
“Rabbit-ear fold”

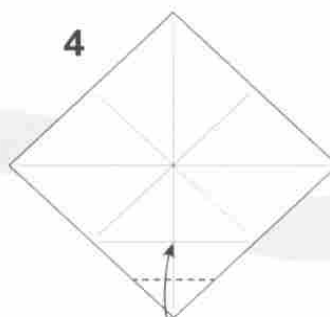

6
7
Plegar y desplegar.
“Fold and unfold”

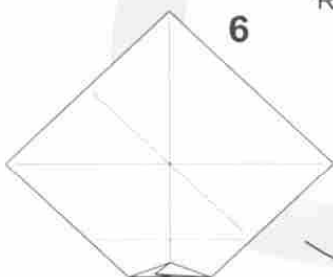

8
9
Plegar en oreja de conejo.
“Rabbit-ear fold”

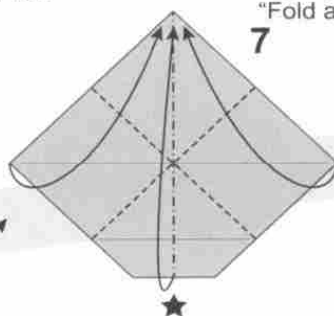

10
11
Plegar usando las líneas existentes.
“Fold using the existing crease lines”

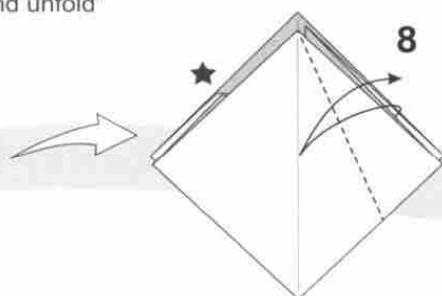

12
13
Plegar y desplegar los bordes.
“Fold and unfold the lower edges”

16

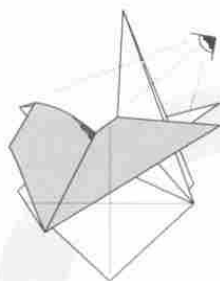

Mirar desde arriba.
"Look from above"

17

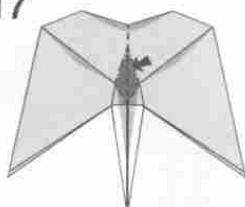

Undir el area indicada.
"Sink the area idicated"

19

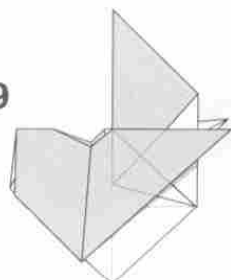

Ver siguiente paso.
"See next step"

15

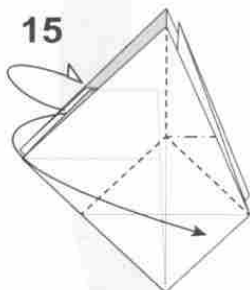

Plegar ambos lados simultáneamente
y ver el siguiente paso .
"Fold both sides simultaneously
and see the next step"

18

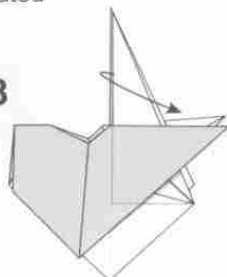

Abrir la solapa hacia la derecha..
"Open the flap to the right "

13

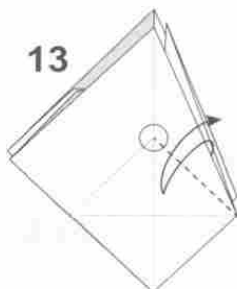

Plegar y desplegar
hacia la referencia
"Fold and unfold
to the reference"

12

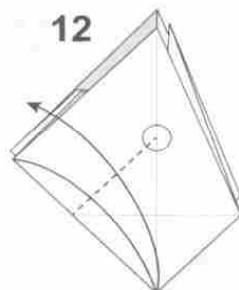

Plegar y desplegar
hacia la refernecia.
"Fold and unfold
to the reference"

14

12-13

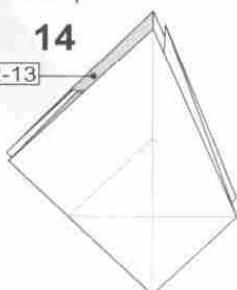

Repetir los paso 12-13 por detrás.
"Repeat steps 12-13 behind"

9

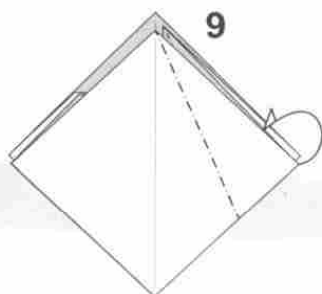

Plegar hacia el interior.
"Inside reverse fold"

10

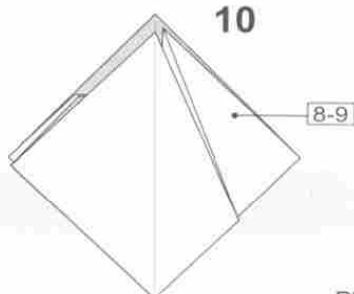

Repetir los pasos 8 - 9.
"Repeat steps 8- 9"

11

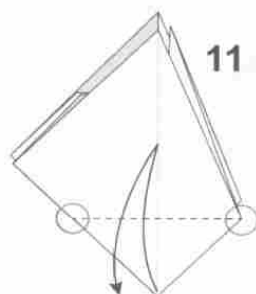

Plegar y desplegar sobrelas referencias.
"Fold and unfold beteewn refernces"

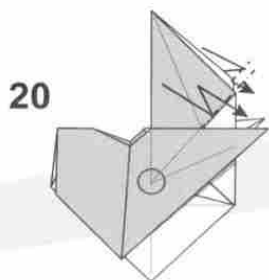

20

Engarzar hacia afuera.
"Crimp outside"

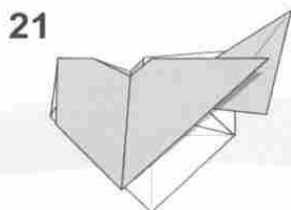

21

Rotar el modelo.
"Rotate the model"

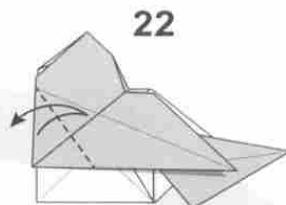

22

Plegar y desplegar
hacia la referencia.
"Fold and unfold to
the reference"

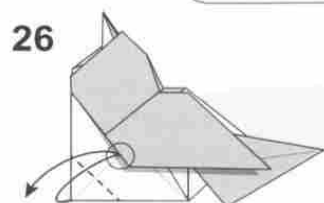
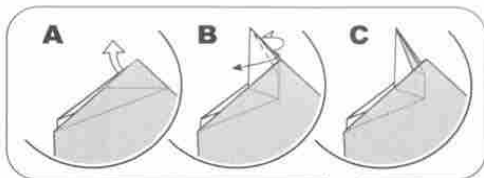

26

Plegar y desplegar hacia la referencia.
"Fold and unfold to the reference"

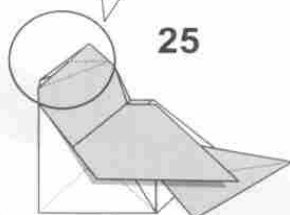

25

Enfocarse en el área indicada.
"Focus on the indicated area"

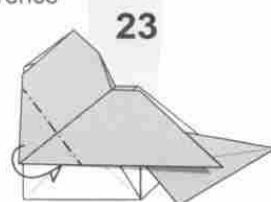

23

Plegar en monte
y repetir del otro lado.
"Mountain fold
and repeat behind"

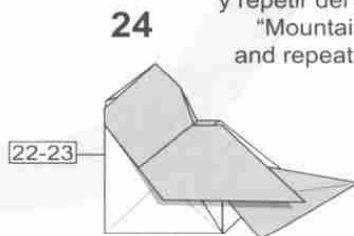

24

Repetir los pasos 22 - 23 en el otro lado.
"Repeat steps 22 - 23 in another side"

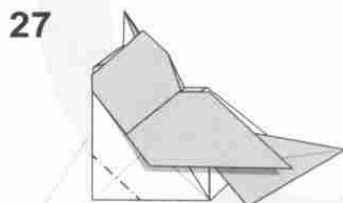

27

Enfocarse en el área indicada.
"Focus on the indicated area"

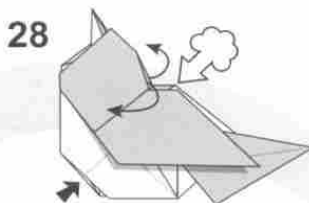
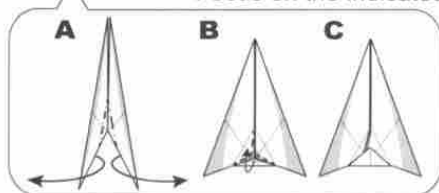

28

Presionar el pecho y la cola,
abrir el cuello e inchar.
"Press the chess and tail,
open neck the and Puff up"

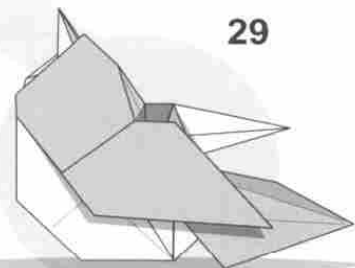
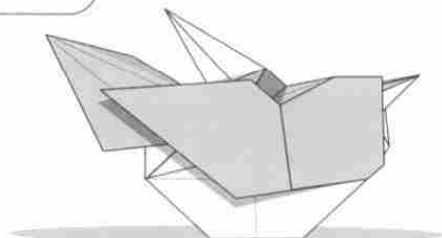

29

Modelo completado.
"Model completed"

Arapaima

by Junior Javier Vivanco Garcia : Peru

Diagram by Junior Javier Vivanco Garcia

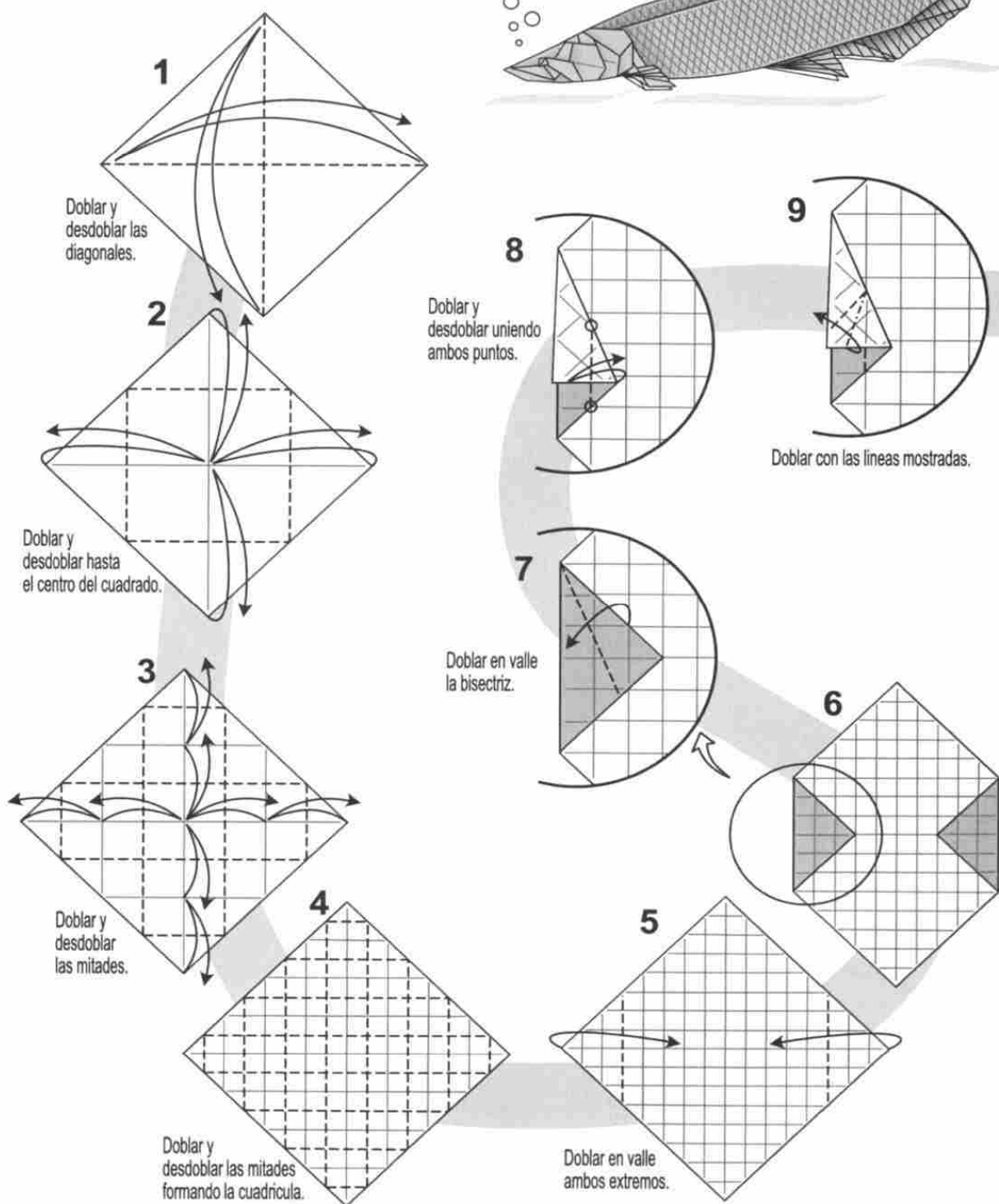
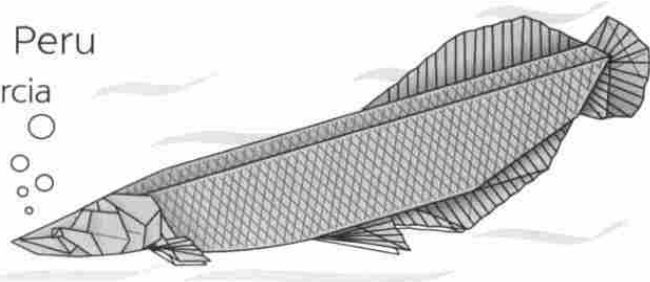

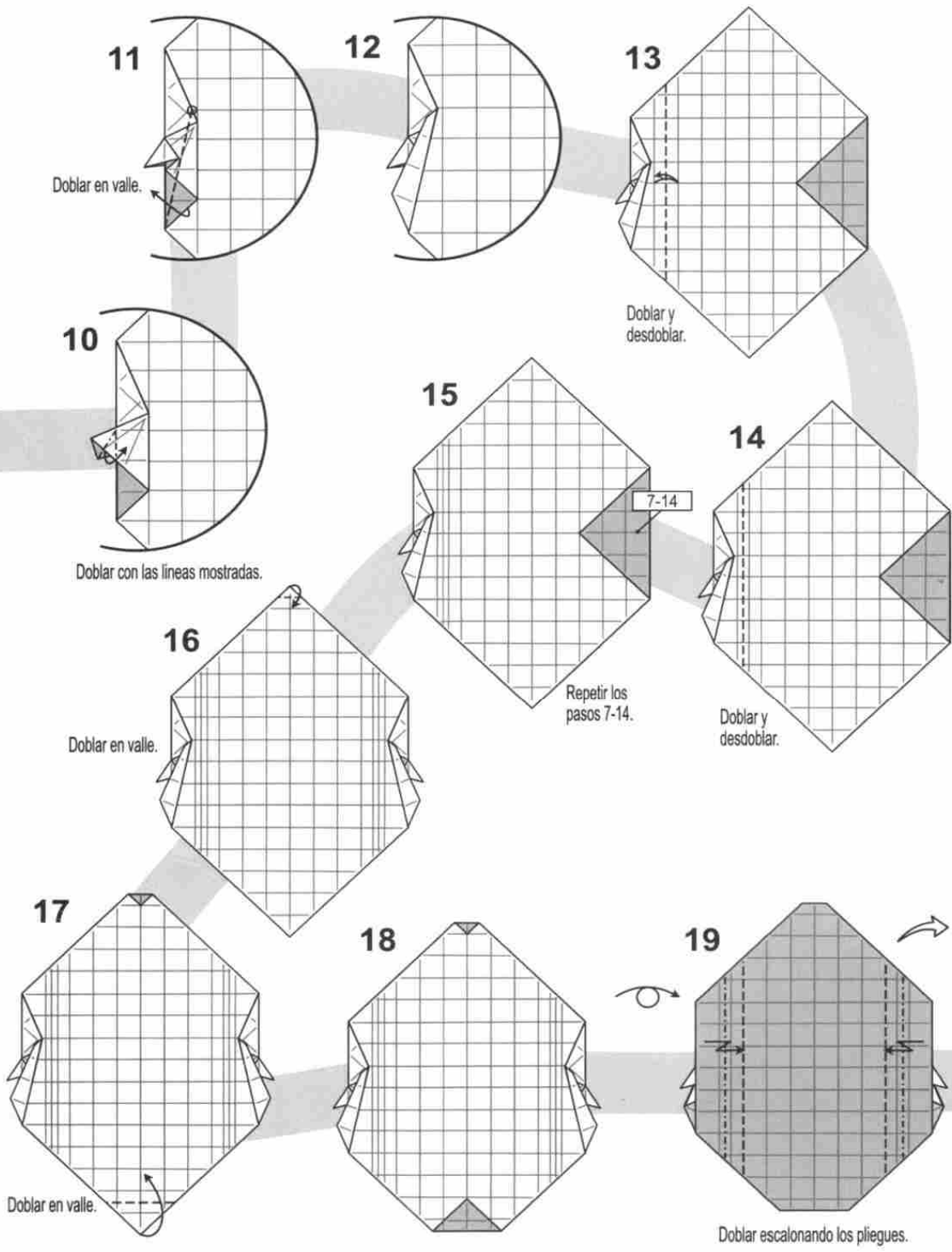

11

Doblar en valle.

12

13

Doblar y
desdoblar.

10

Doblar con las líneas mostradas.

15

7-14

Repetir los
pasos
7-14.

14

Doblar y
desdoblar.

16

Doblar en valle.

17

Doblar en valle.

18

19

Doblar escalonando los pliegues.



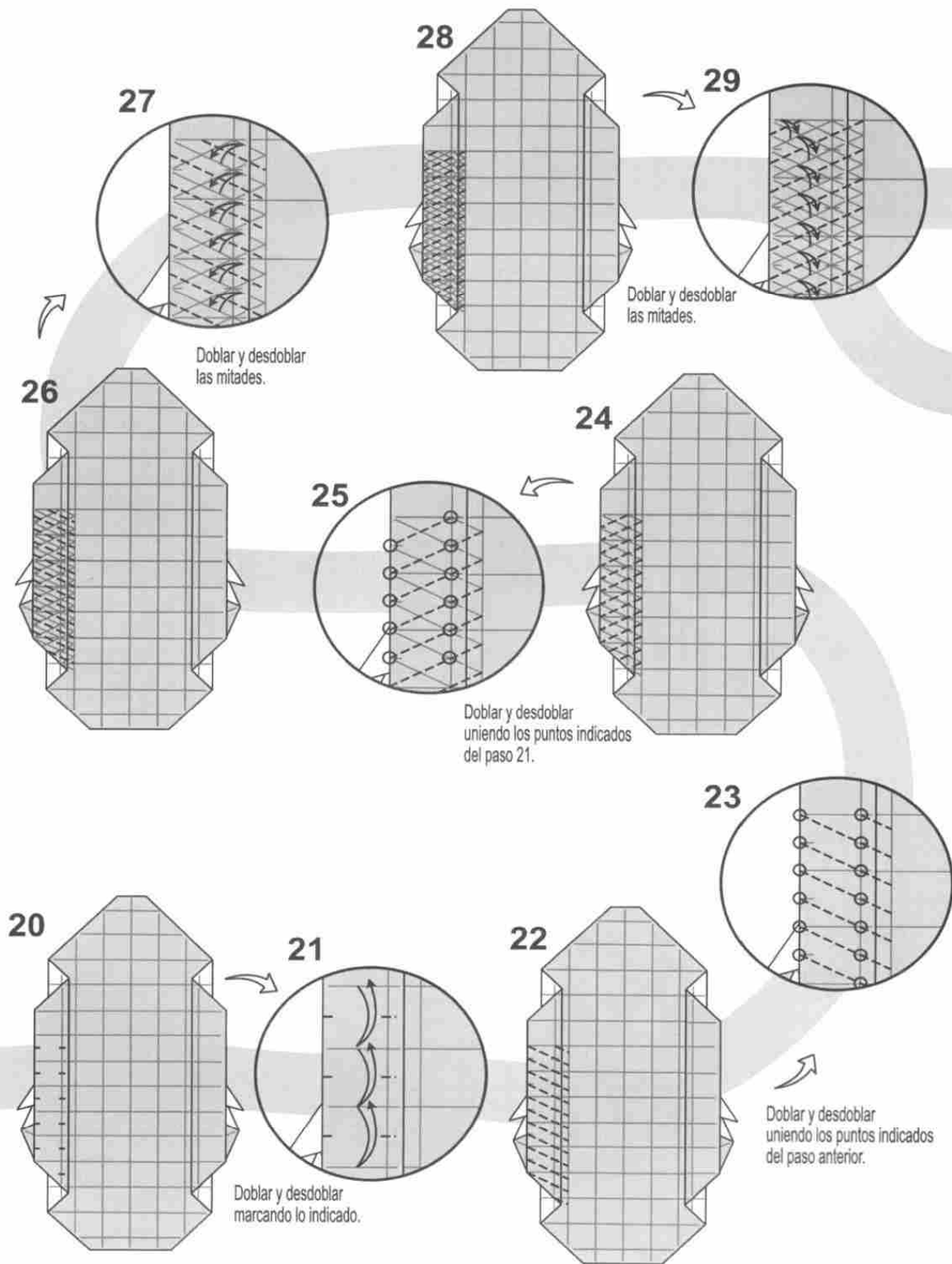

30a

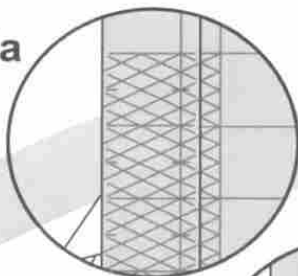

30b

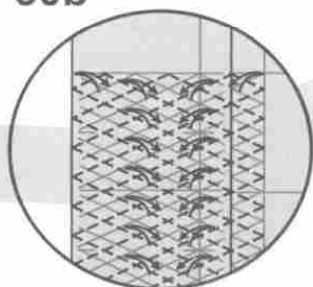

Doblar y desdoblar las mitades.

Paso opcional
(Para papeles grandes).

31

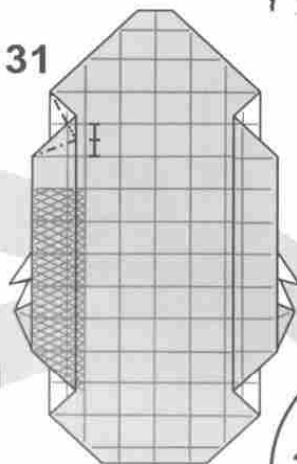

32

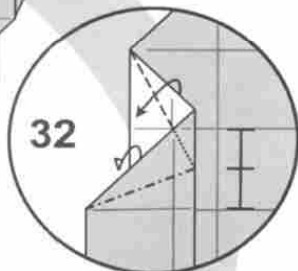

Doblar deslizando los pliegues.

34

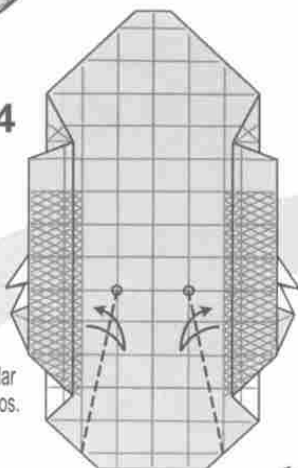

Doblar y desdoblar uniendo los puntos.

33

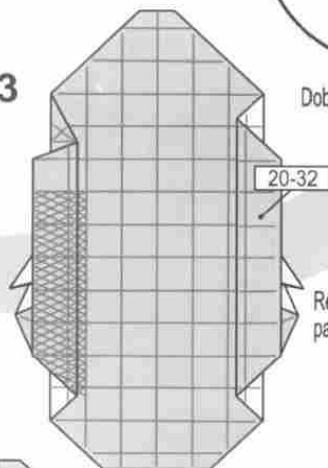

Repetir los pasos 20-32.

35

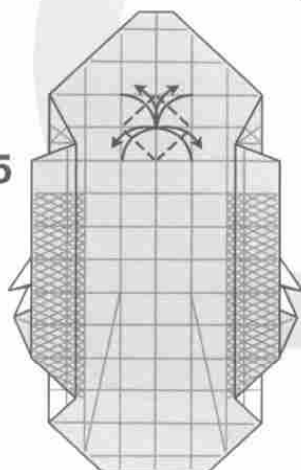

Doblar y desdoblar lo indicado.

36

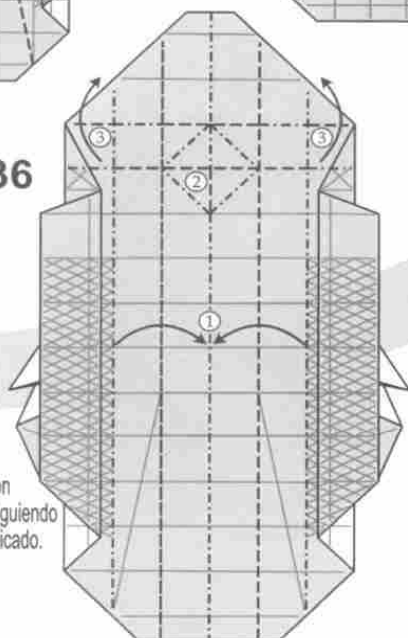

Colapsar con paciencia siguiendo el orden indicado.

37

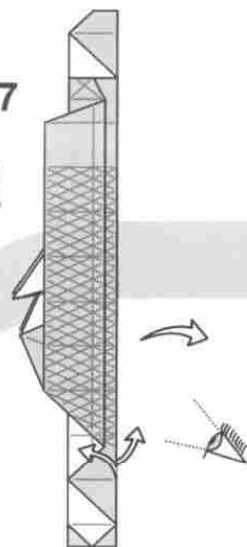

Este es el resultado, abrir las capas de la cola.

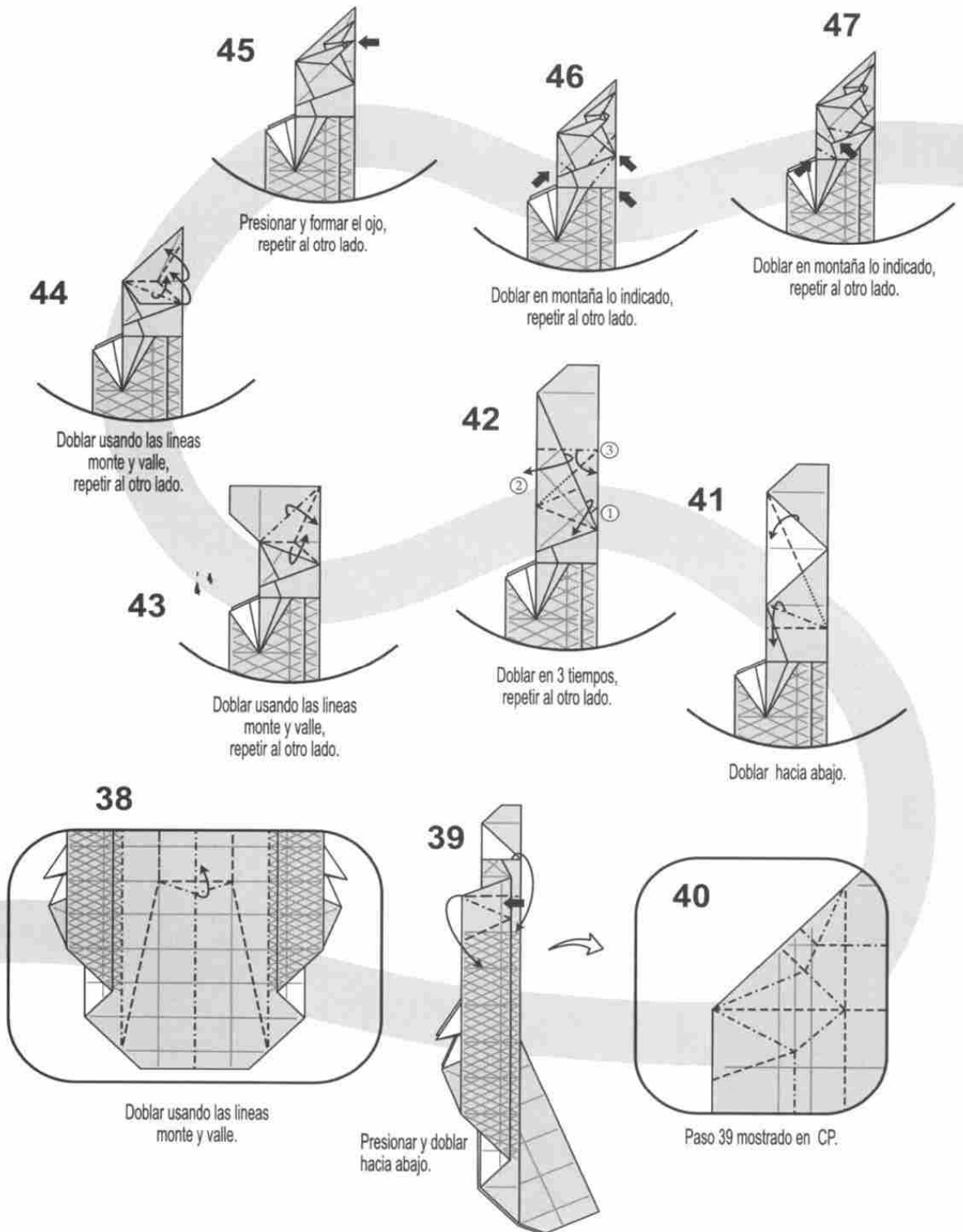

47

Doblar y
desdoblar.

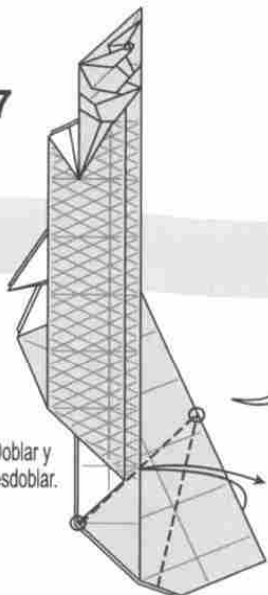

48

Doblar usando las líneas
monte y valle,
repetir al otro lado.

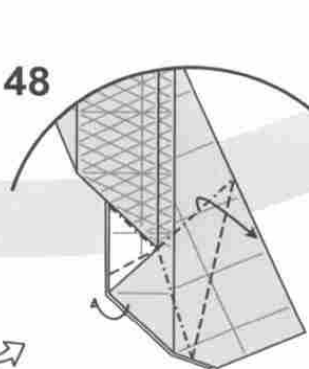

49

Doblar deslizando la capa.

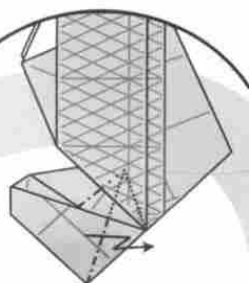

50

Doblar en montaña.

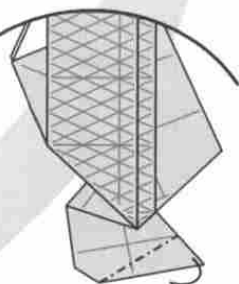

51

Doblar en montaña.

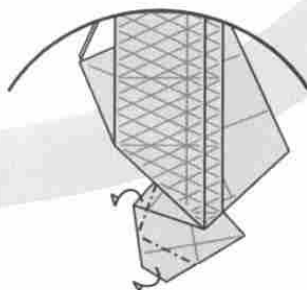

52

Doblar en valle
realizando el cambio
de color de las aletas.

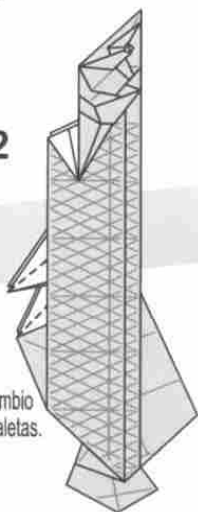

53

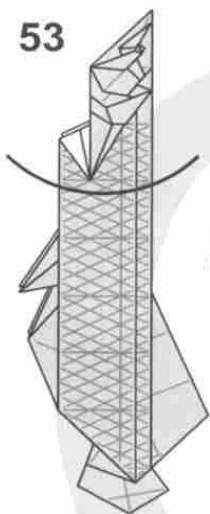

56

55

Doblar en montaña y hundir.

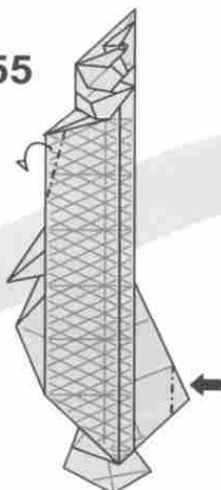

57

Escalonar en ambos lados.

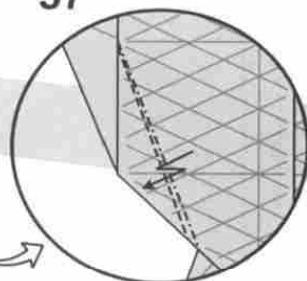

54

Doblar formando ambas aletas.



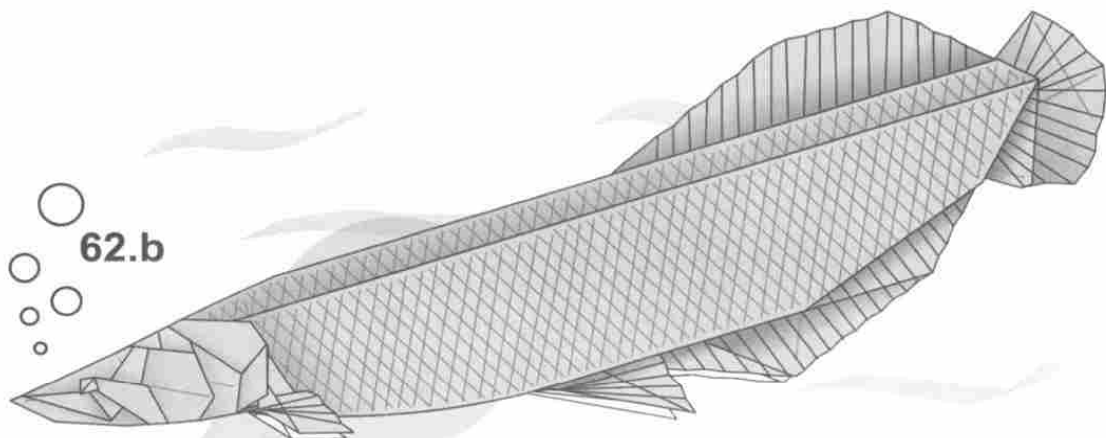

62.b

Modelo de papel grande finalizado.

62.a

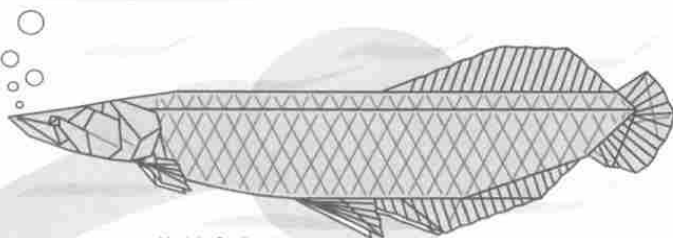

Modelo finalizado.

61

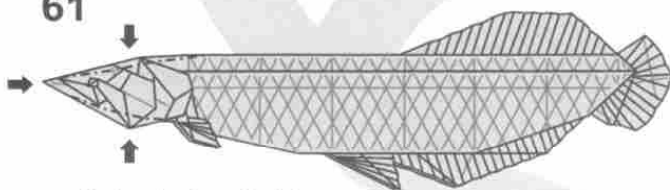

Dar forma la cabeza del paiche.

58

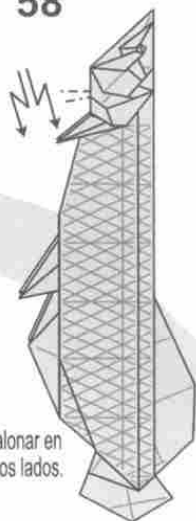

Escalonar en ambos lados.

60

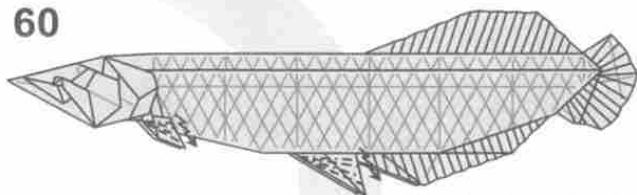

Doblar dando forma a las aletas.

59

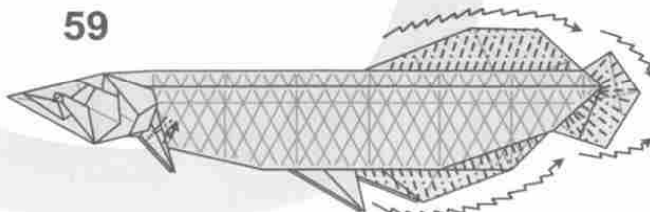

Doblar dando forma a las aletas.

사자 Lion

by Miyamoto Mariko : Japan

Diagram by Miyamoto Mariko

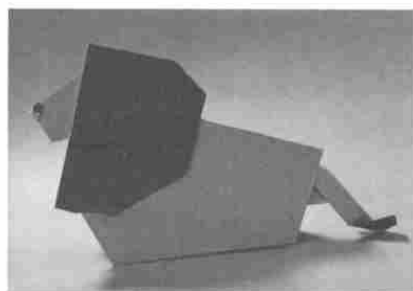

① 頭

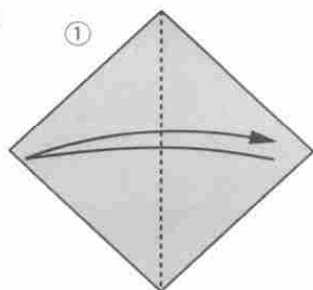

②

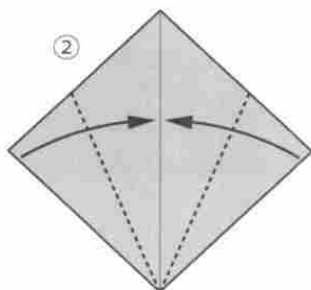

③

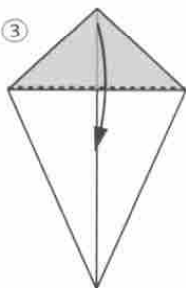

④

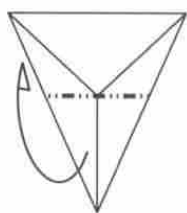

⑤

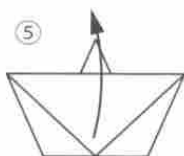

⑥

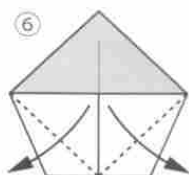

⑦

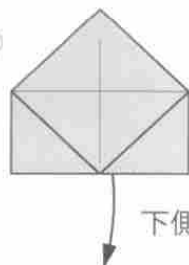

下側を戻す

⑧

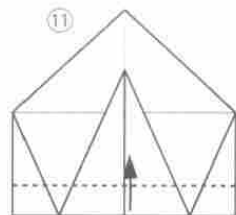

⑧の折り筋で折る

⑩

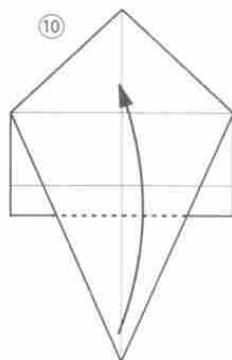

⑨

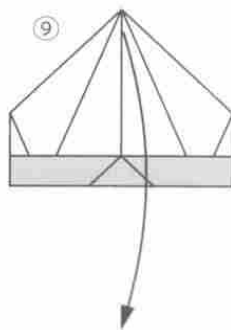

⑧

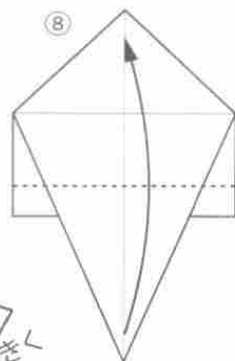

図大きく
うらがえす

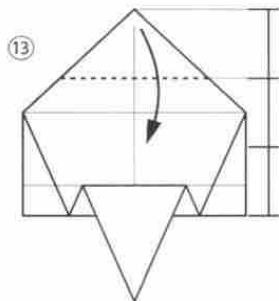
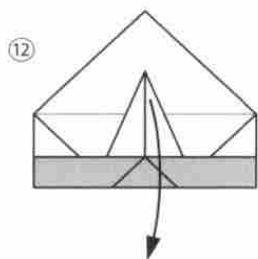

約3分の1
折り下げる

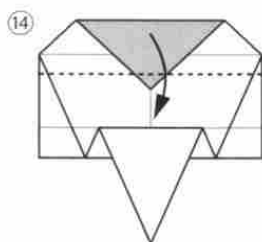

ふちに合わせて折る

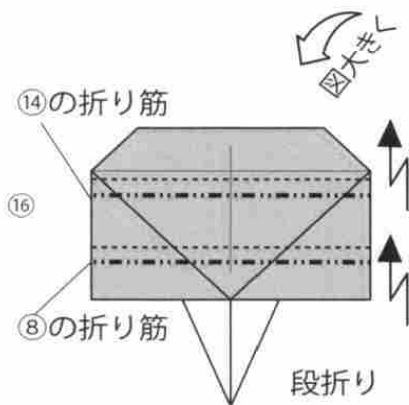
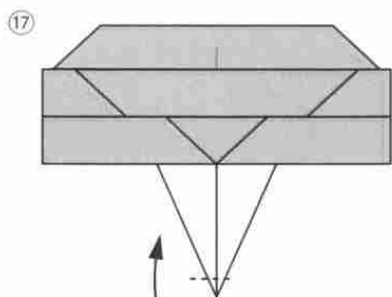
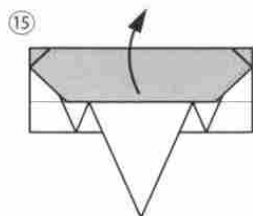

段折り



うらがえす

鼻の先を約6ミリ折る
※尾の先と同じように
いったん広げてから折る

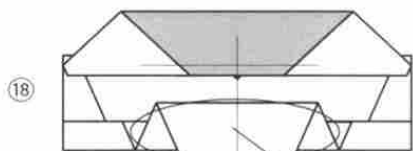

18

うしろへ
出しておく

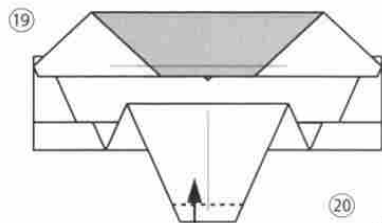

19

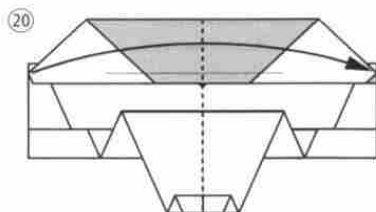

20

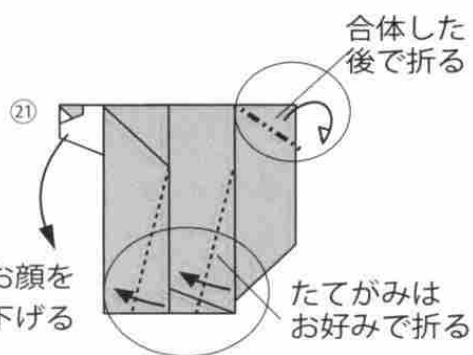

合体した
後で折る

お顔を
下げる

たてがみは
お好みで折る



図大きく

向き替え

体 頭③より

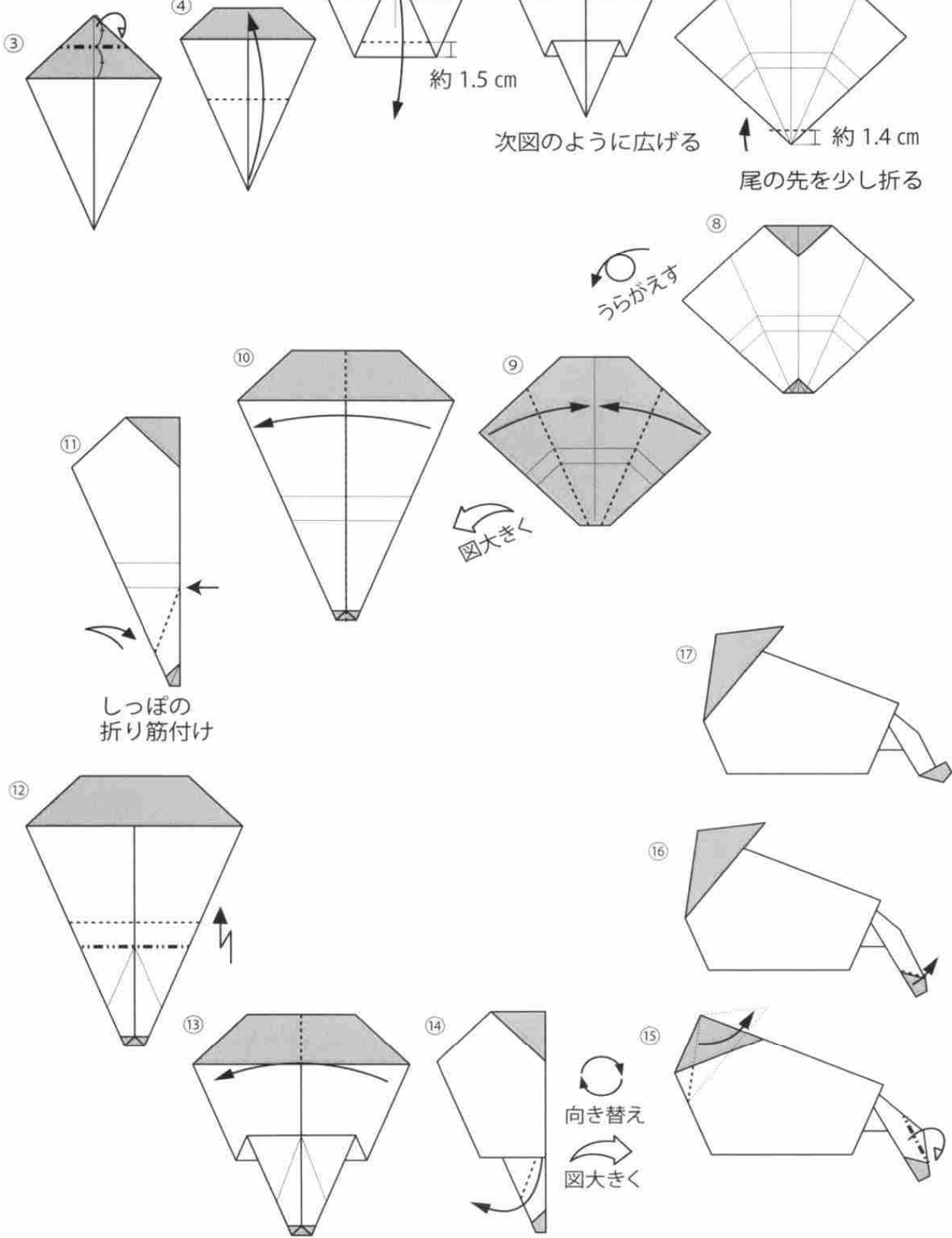

Wild buffalo

by Lien Quoc Dat : Vietnam

Diagram by Lien Quoc Dat

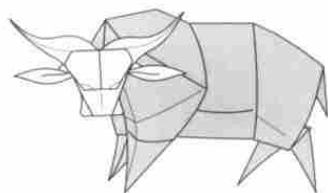

1



2

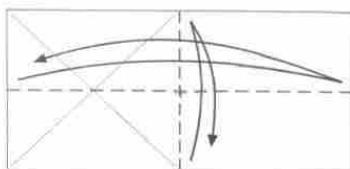

3

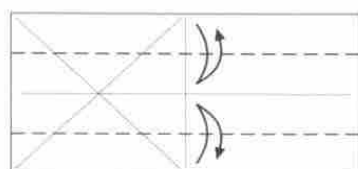

4

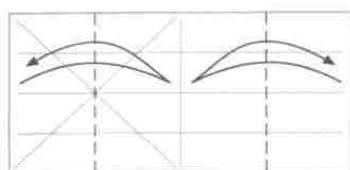

5

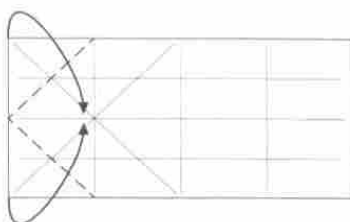

6

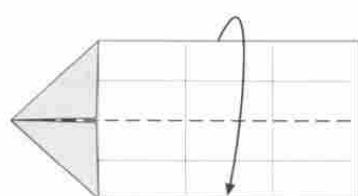

7

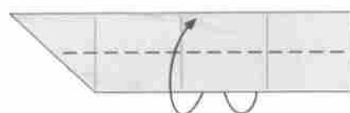

8



9



10



11

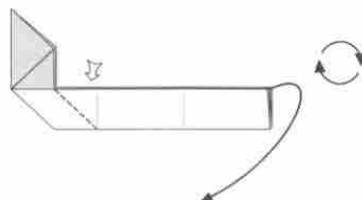

12

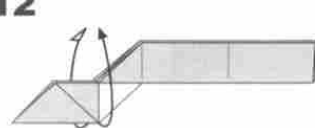

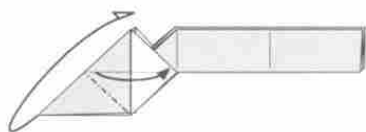
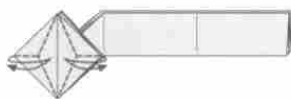
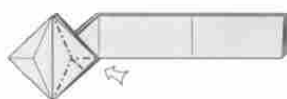
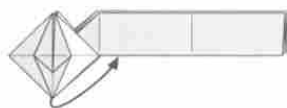
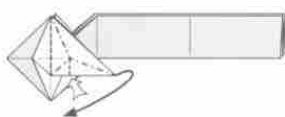
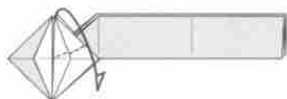
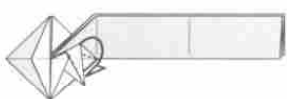
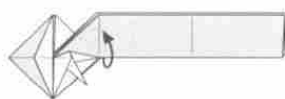
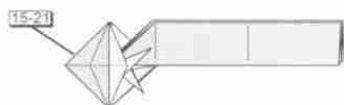
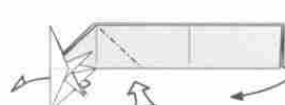
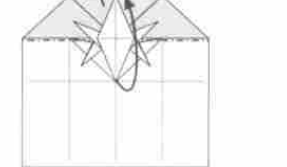
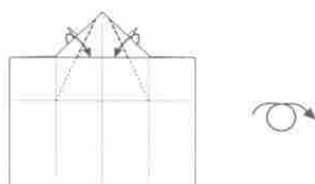
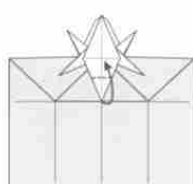
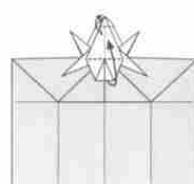
13**14****15****16****17****18****19****20****21****22****23****24****25****26****27**

28

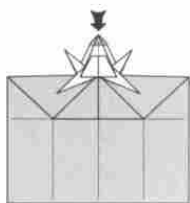

29

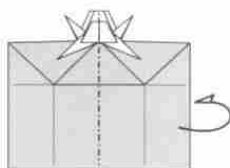

30



31



32

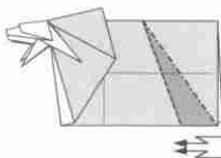

33

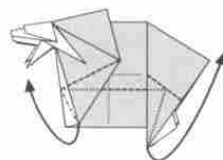

34

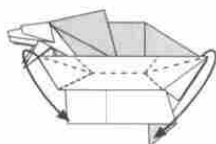

35

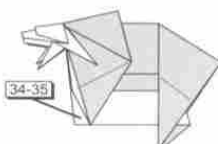

36

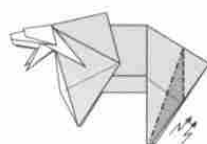

37

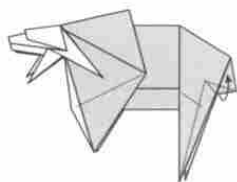

38

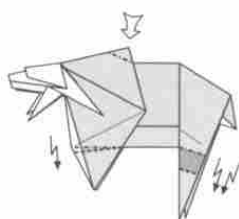

39

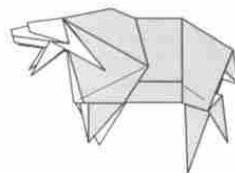

40

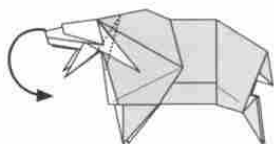

41

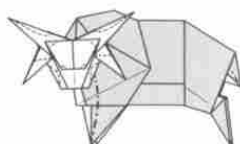

42

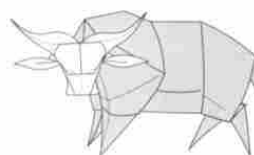

나무늘보 Sloth

by Yoo TaeYong : Korea

Diagram by Yoo TaeYong

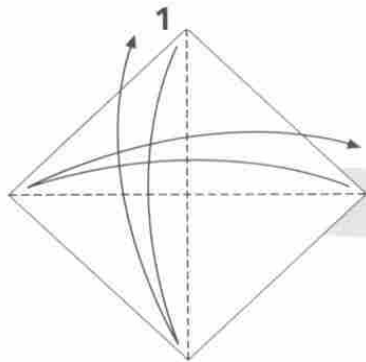
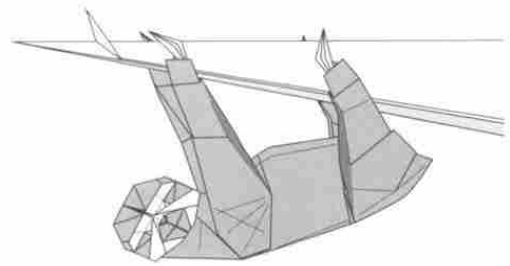

1 대각선으로 접었다 펴주세요.

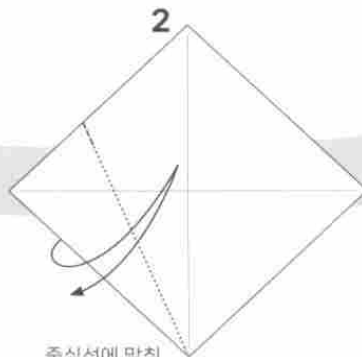

2 중심선에 맞춰 조금만 접었다 펴주세요.

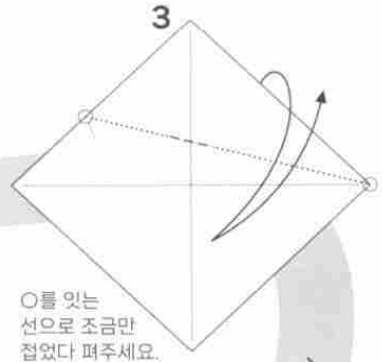

3 ○를 잇는 선으로 조금만 접었다 펴주세요.

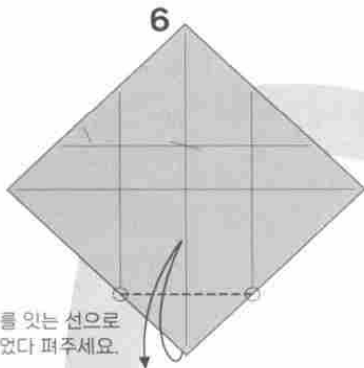

4 ○를 잇는 선으로 접었다 펴주세요.

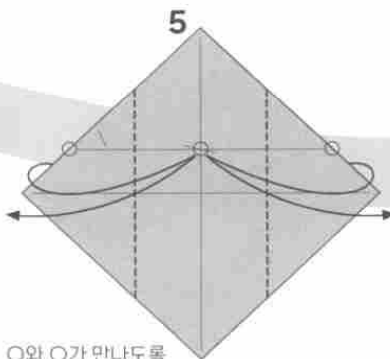

5 ○와 ○가 만나도록 접었다 펴주세요.

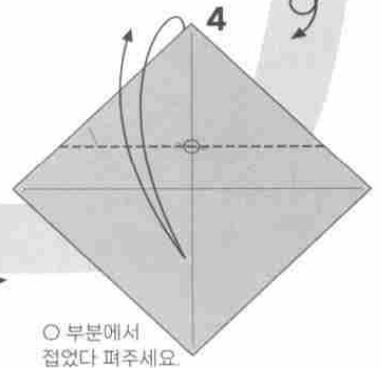

6 ○ 부분에서 접었다 펴주세요.

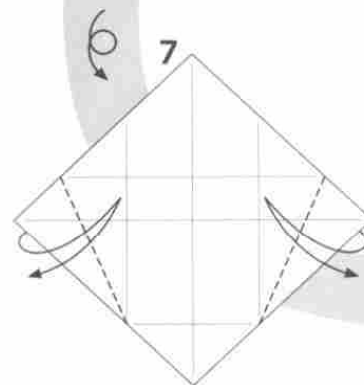

7 접기선에 맞춰 접었다 펴주세요.

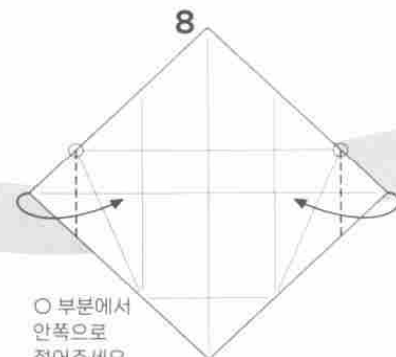

8 ○ 부분에서 안쪽으로 접어주세요.

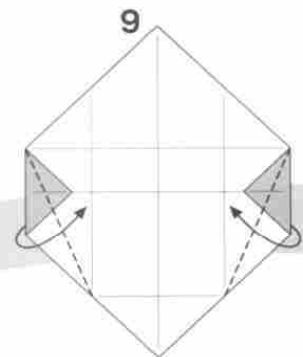

9 접기선대로 올려 접어주세요.

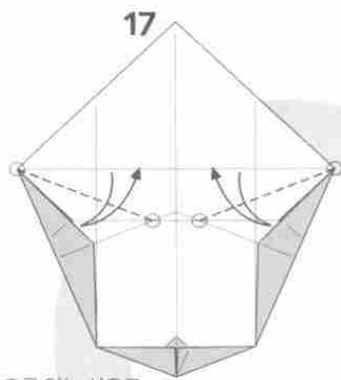

○를 잇는 선으로
접었다 펴주세요.

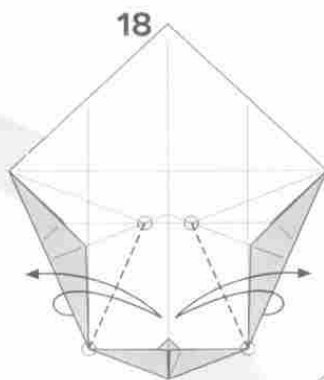

○를 잇는 선으로
접었다 펴주세요.

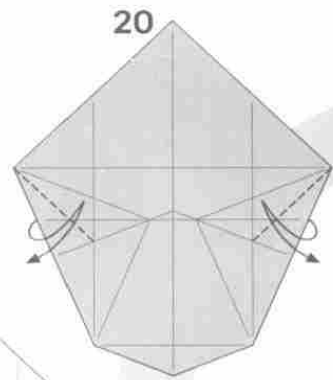

접기선에 맞춰
접었다 펴주세요.

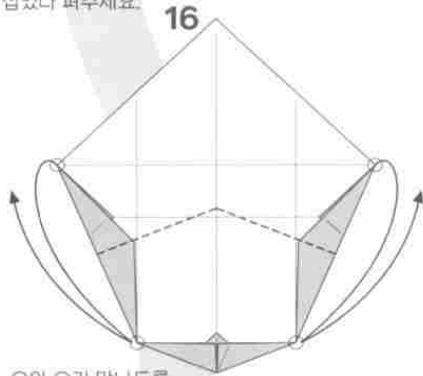

○와 ○가 만나도록
접었다 펴주세요.

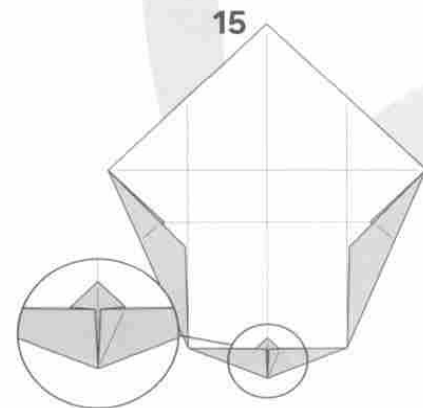
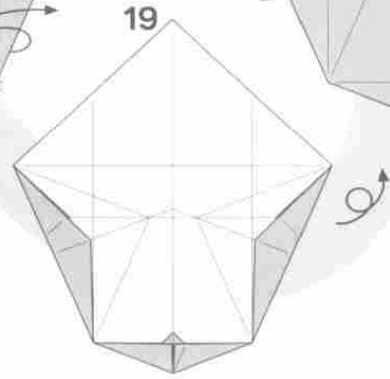

뒤쪽에 있는 종이를
앞으로 빼주세요.

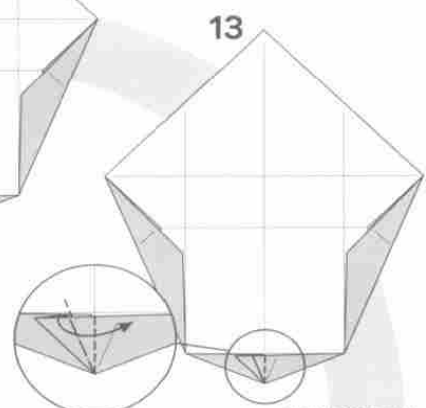
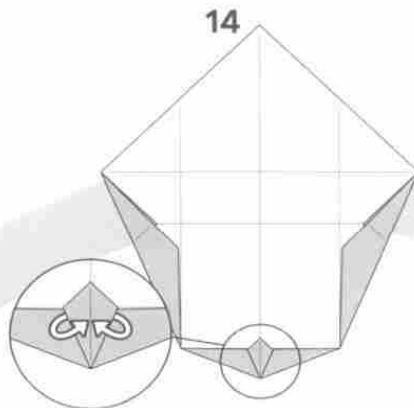

반대쪽으로 펼쳐
눌러 접어주세요.

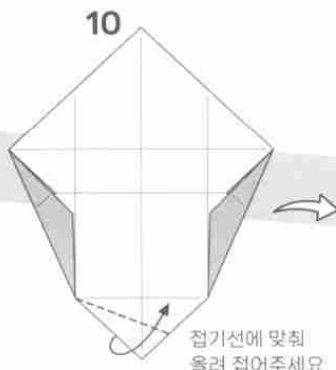

접기선에 맞춰
올려 접어주세요.

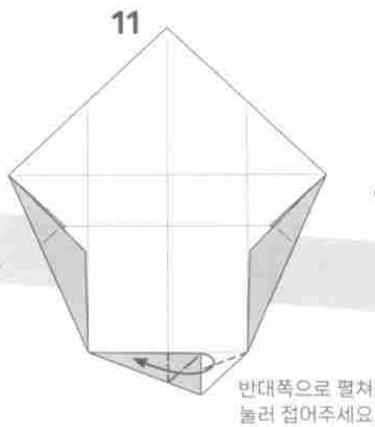

반대쪽으로 펼쳐
눌러 접어주세요.

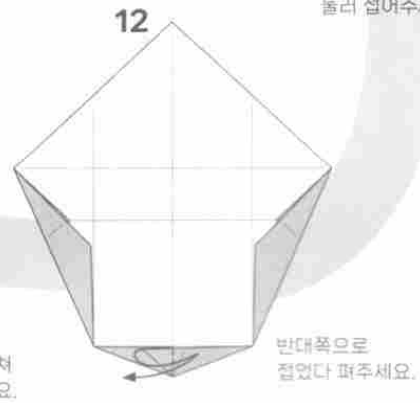

반대쪽으로
접었다 펴주세요.

21

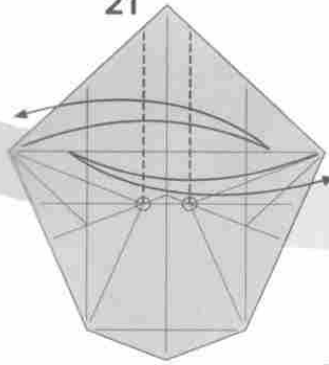

○ 부분에서 양쪽 다 접었다 펴주세요.

22

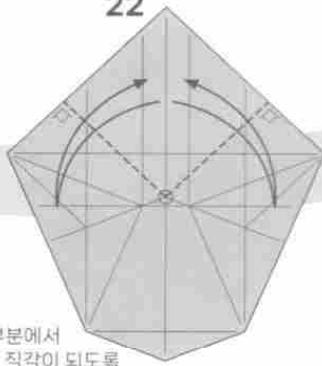

○ 부분에서 변과 직각이 되도록 접었다 펴주세요.

23

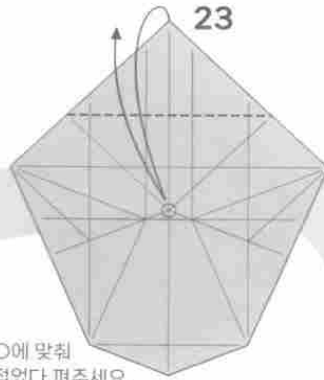

○에 맞춰 접었다 펴주세요.

24

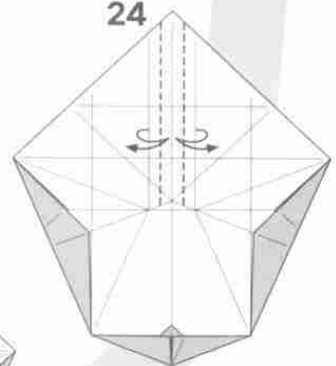

반의 간격으로 접었다 펴주세요.

26

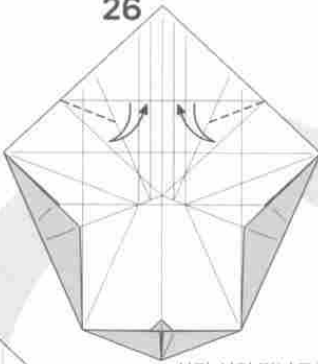

선과 선이 만나도록 접었다 펴주세요.

25

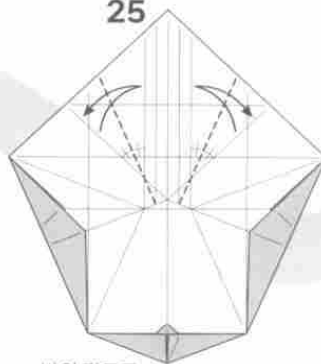

반의 각도로 접었다 펴주세요.

27

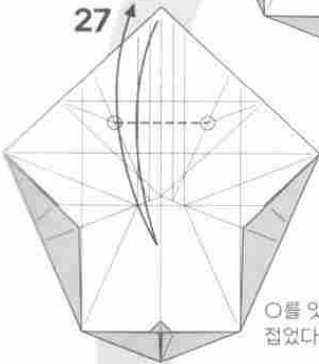

○를 잇는 선으로 접었다 펴주세요.

30

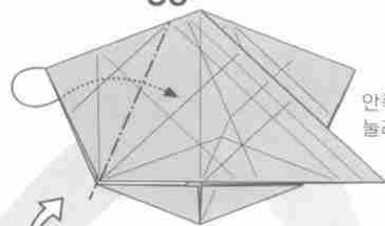

안쪽으로 펼쳐 눌러 접어주세요.

28

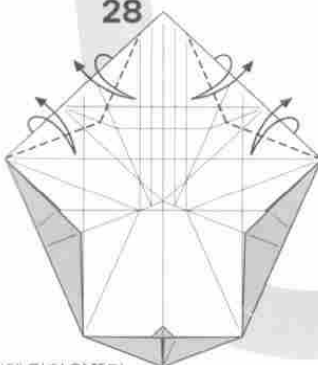

선에 맞춰 양쪽 다 접었다 펴주세요.

29

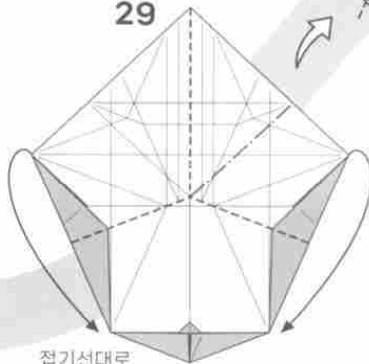

접기선대로 모아 접어주세요.

31

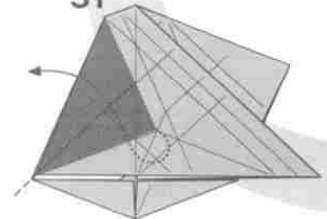

검은 부분을 안쪽으로 펼쳐 눌러 접어주세요.

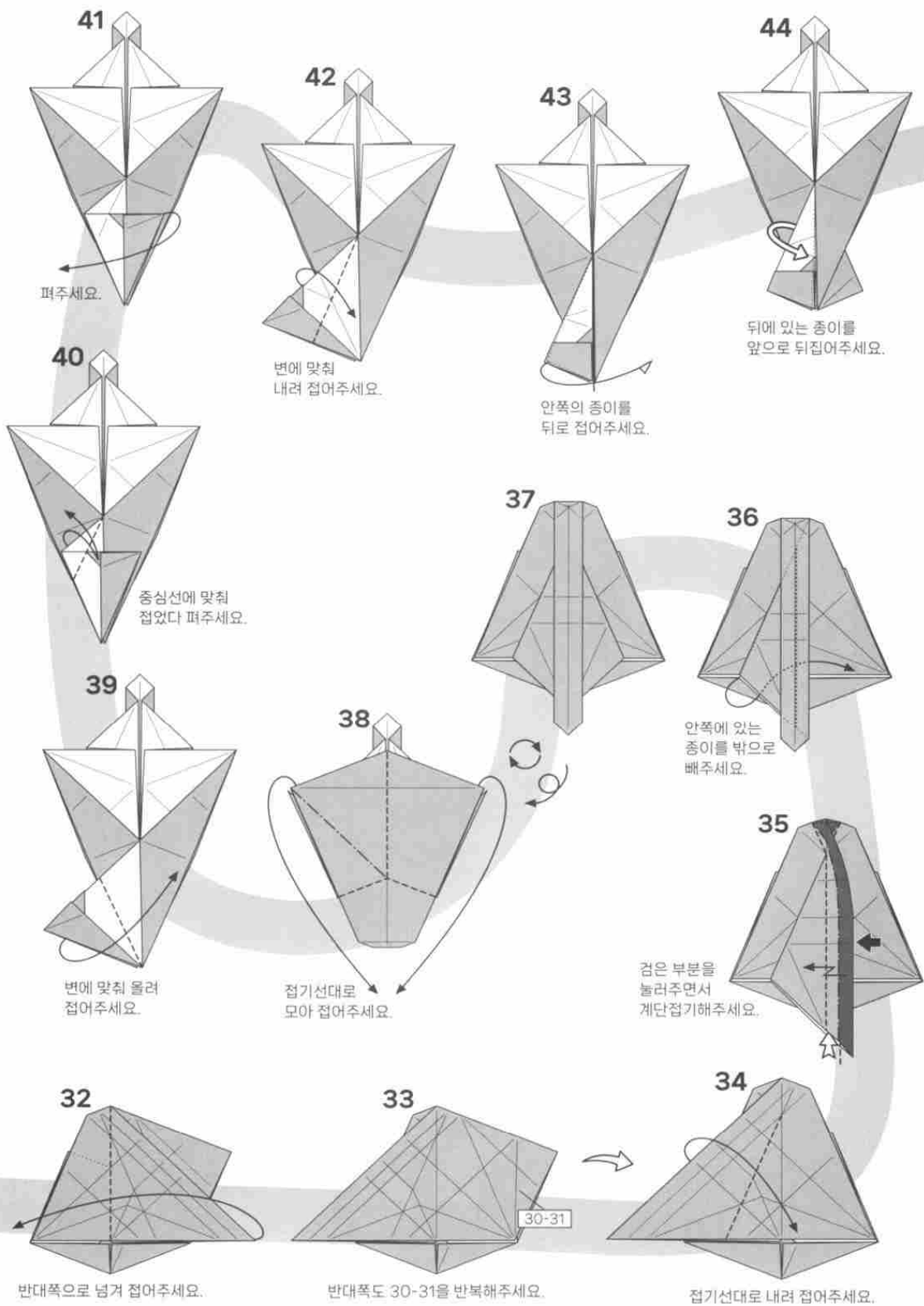

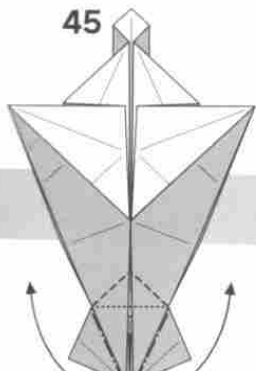

45
접기선대로 위로
펼쳐 눌러 접어주세요.

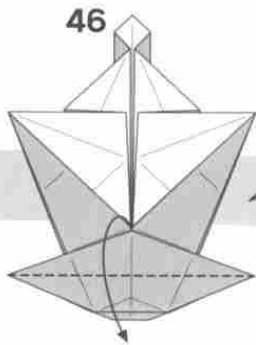

46
아래로 내려 접어주세요.

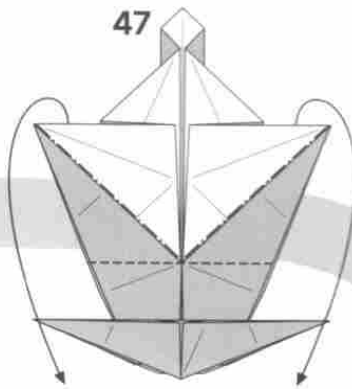

47
접기선대로 양쪽 다
아래로 내려 접어주세요.

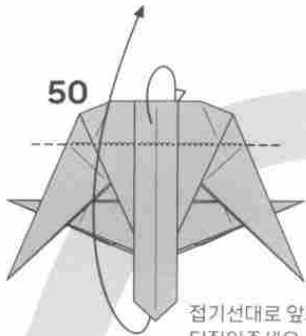

50
접기선대로 앞과 뒤를
뒤집어주세요.

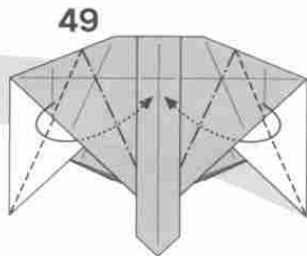

49
접기선대로 양쪽 다
안쪽으로 접어주세요.

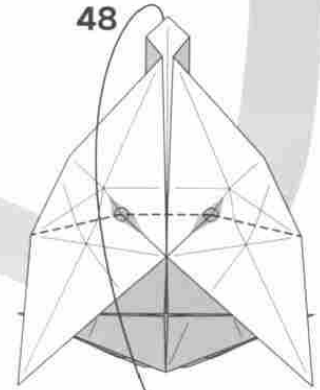

48
○ 부분에서
접기선대로 내려
접어주세요.

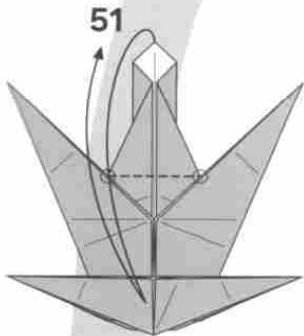

51
○를 잇는 선으로
접었다 펴주세요.

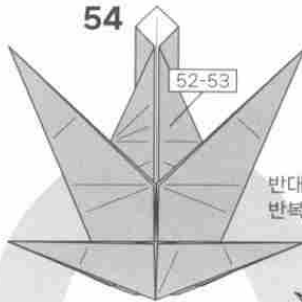

54
반대쪽도 52-53을
반복해주세요.

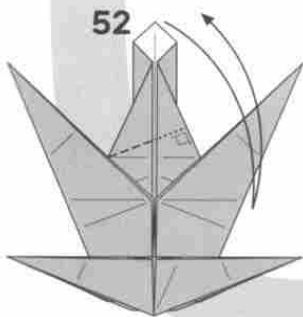

52
변과 직각이 되도록
조금만 접었다 펴주세요.

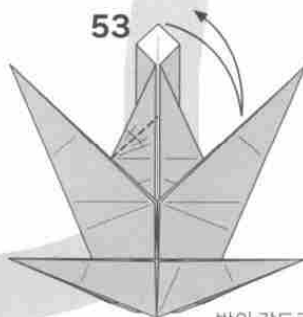

53
반의 각도로 조금만
접었다 펴주세요.

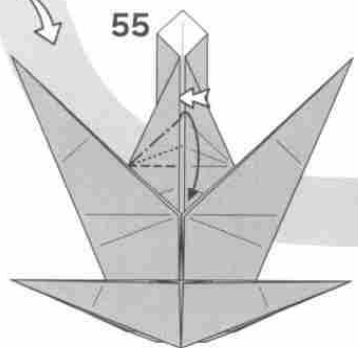

55
아래로 펼쳐 눌러 접어주세요.

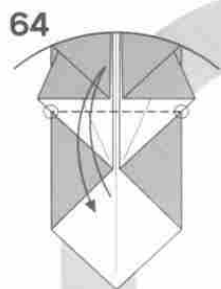

○를 잇는 선으로
접었다 펴주세요.

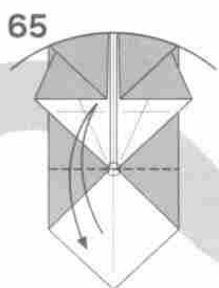

○ 부분에서
접었다 펴주세요.

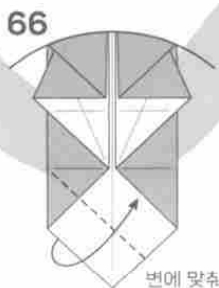

변에 맞춰 돌려
접어주세요.

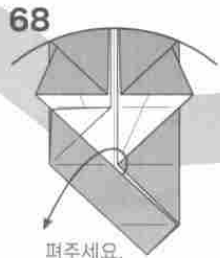
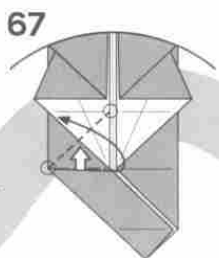

펴주세요.

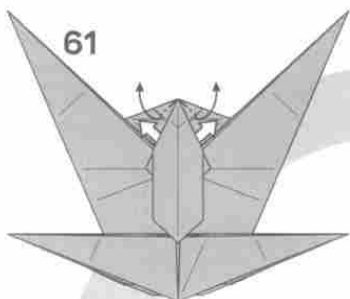
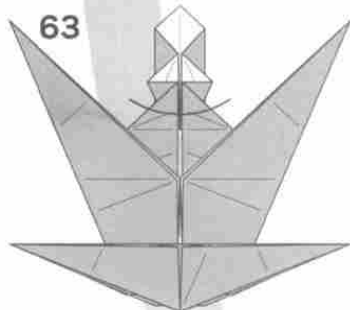

접혀있는 부분을 밖으로 빼주세요.

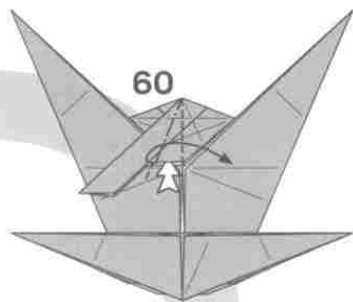

반대쪽으로 펼쳐 눌러 접어주세요.

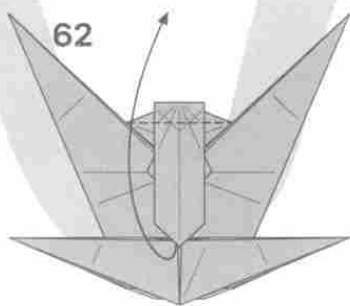

위로 올려 접어주세요.

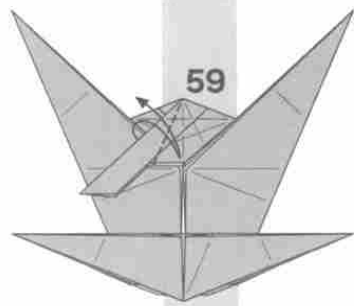

중심선에 맞춰 접었다 펴주세요.

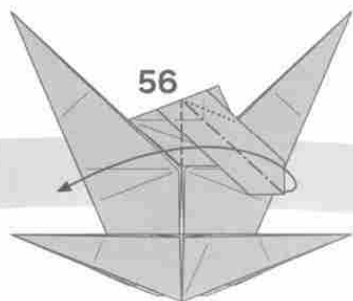

반대쪽으로 펼쳐 눌러 접어주세요.

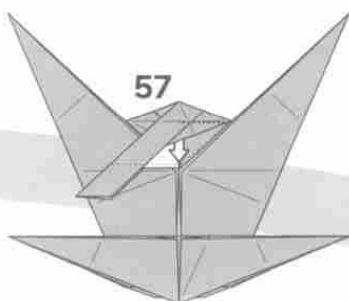

안쪽에 있는 종이를 밖으로 빼주세요.

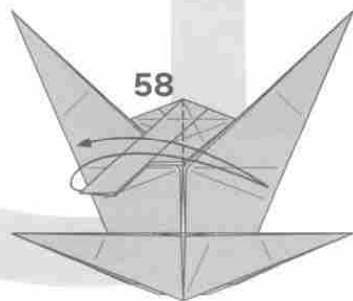

반대쪽으로 펼쳐 눌러 접어주세요.



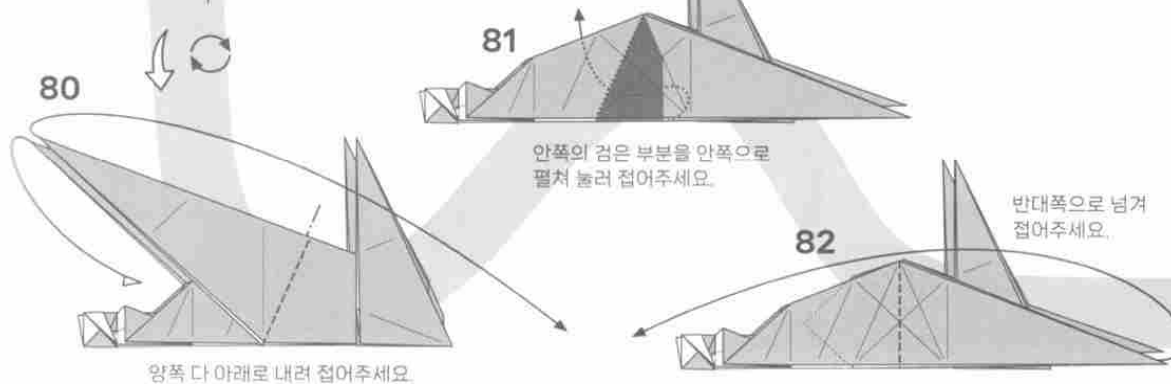
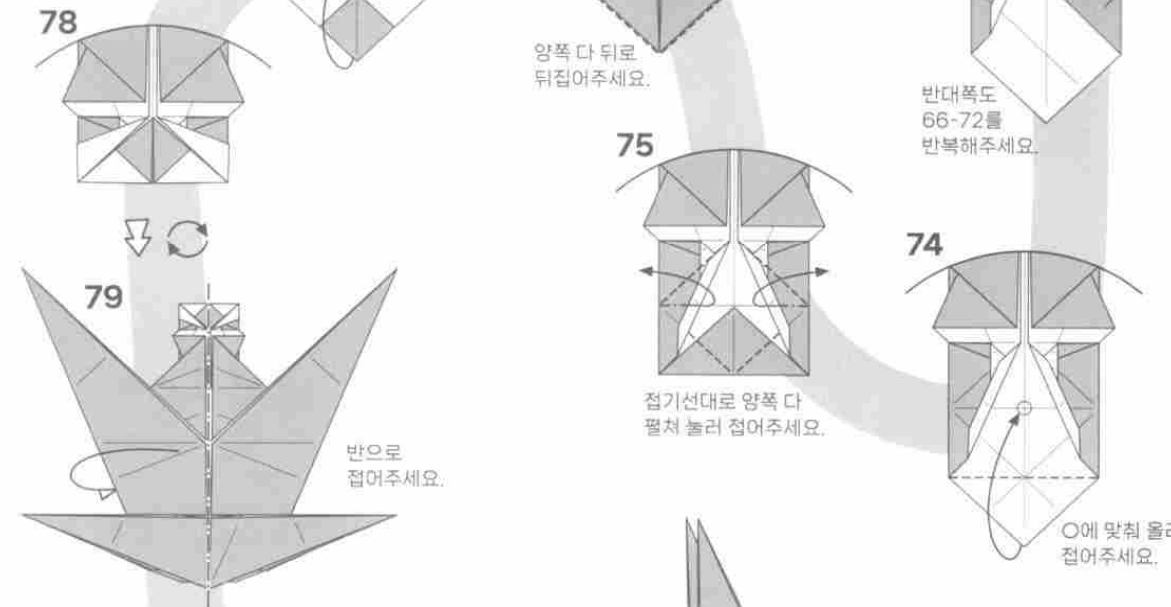
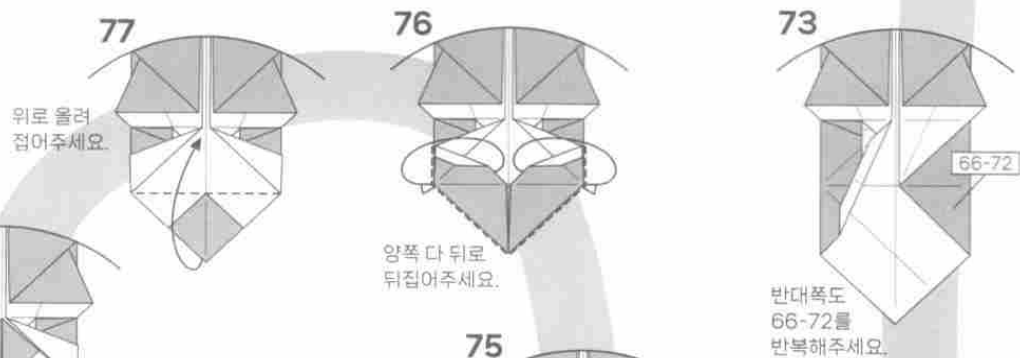
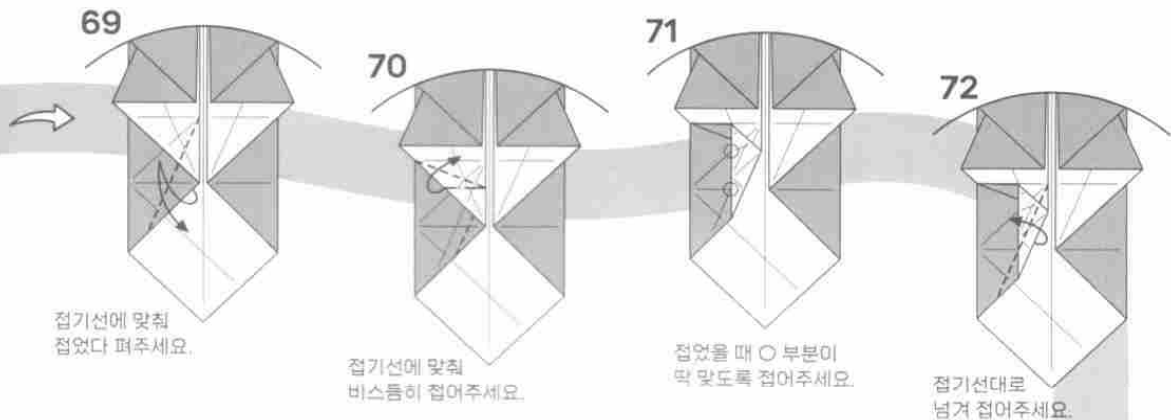

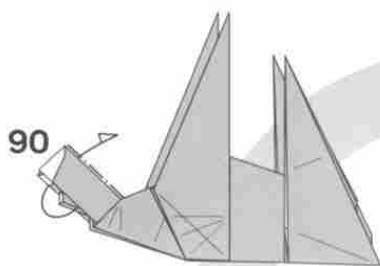

90

안쪽으로 펼쳐 눌러 접어주세요.

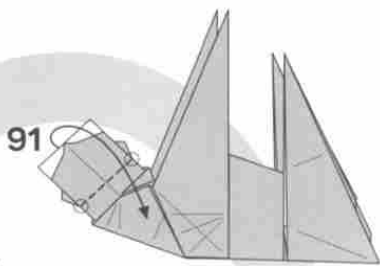

91

O를 잇는 선으로 내려 접어주세요.

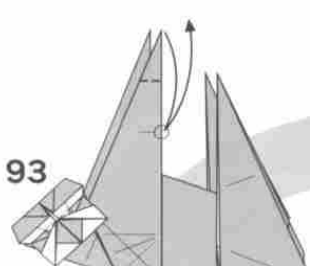

93

O에 맞춰 접었다 펴주세요.

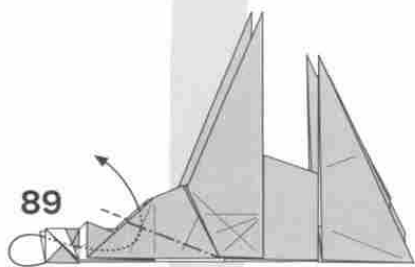

89

안쪽으로 펼쳐 눌러 접어주세요.

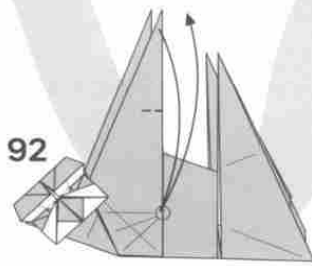

92

O에 맞춰 조금만 접었다 펴주세요.

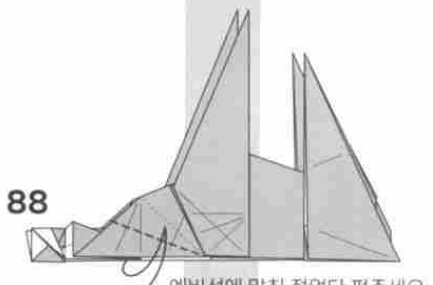

88

예비선에 맞춰 접었다 펴주세요.

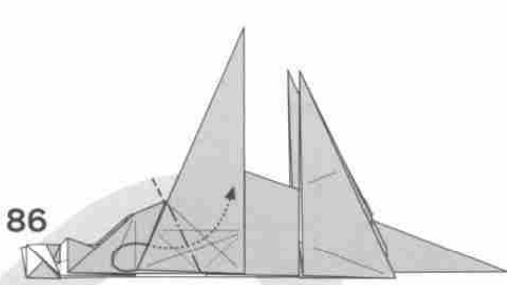

86

O를 잇는 선으로 안쪽으로 펼쳐 눌러 접어주세요.

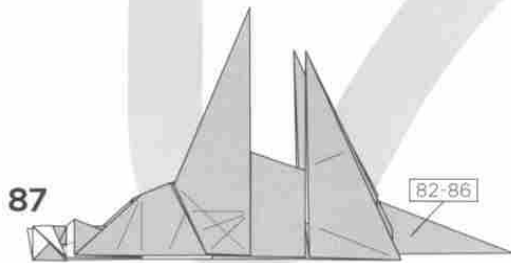

87

반대쪽도 82-86을 반복해주세요.

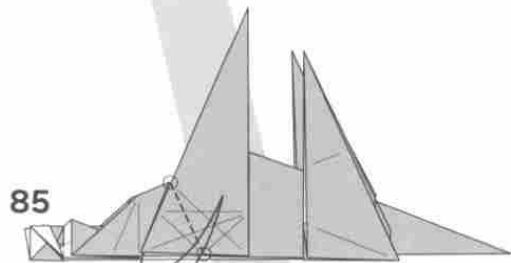

85

O를 잇는 선으로 접었다 펴주세요.

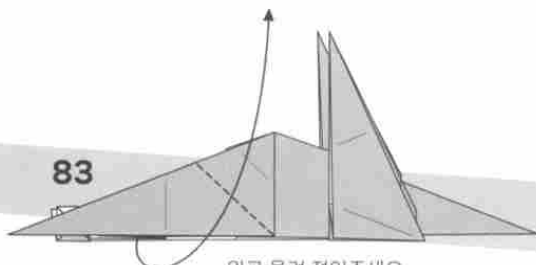

83

위로 올려 접어주세요.

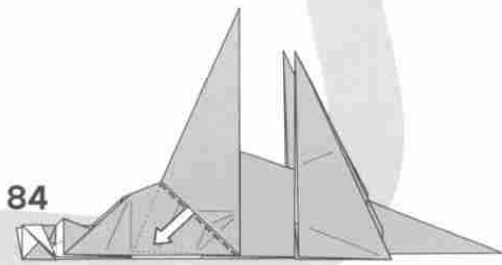

84

안쪽에 있는 종이를 밖으로 빼주세요.

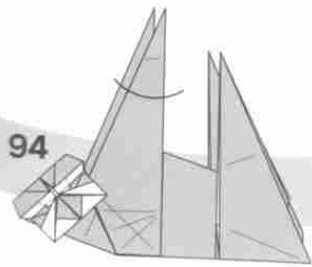

94

95

○부분에서 선에 맞춰
접었다 펴주세요.

96

접기선에 맞춰
접었다 펴주세요.

97

뒤집어 접어주세요.

102

101

아래로 접었다 펴주세요.

98

안쪽에 있는 종이를
밖으로 빼주세요.

99

뒤쪽도 98을 반복해주세요.

100

아래로 접었다 펴주세요.

103

반대쪽도 92-101을
반복해주세요.

104

반으로 조금만 접었다 펴주세요.

105

○에 맞춰 접었다 펴주세요.

106

95-101을 반복해주세요.
(좌우 반전되기 때문에
주의해서 접어주세요)

107

반대쪽도 104-106을
반복해주세요.

117

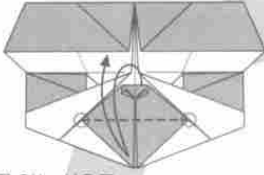

○를 잇는 선으로
접었다 펴주세요.

118

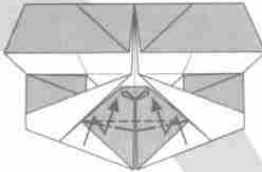

계단접기하면서
입을 만들어주세요.

120

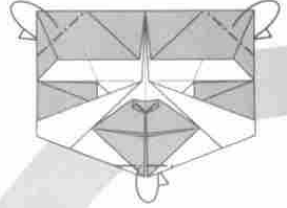

얼굴 형태를 다듬어주세요.

116

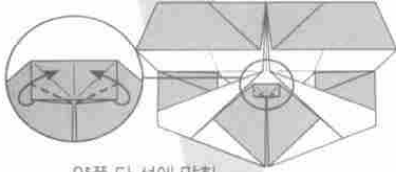

양쪽 다 선에 맞춰
올려 접어주세요.

119

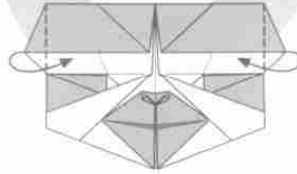

양쪽 다 안쪽으로 접어주세요.

115

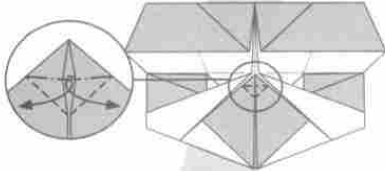

양쪽으로 펼쳐 눌러
접어주세요.

113

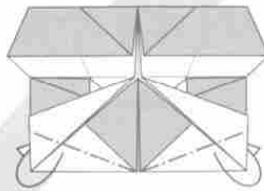

양쪽 다 뒤로 접어주세요.

112

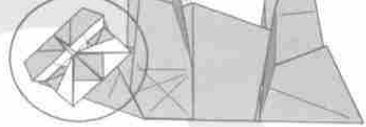

114

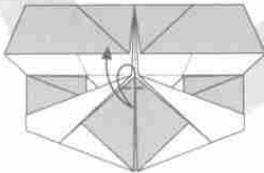

끝부분을 조금만
접었다 펴주세요.

111



반대쪽도 108-110을
반복해주세요.

108

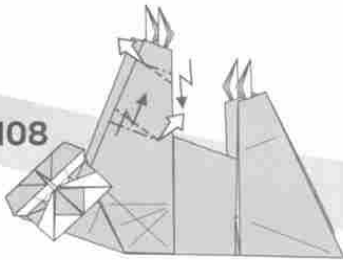

계단접기하면서
앞다리를
다듬어주세요.

109

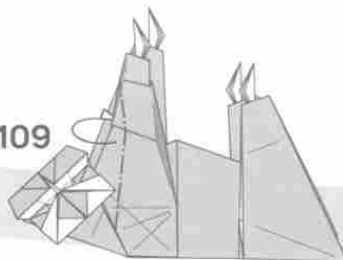

팔을 얇게 다듬어주세요.

110

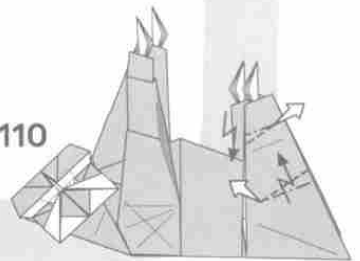

계단접기하면서
뒷다리를
다듬어주세요.

121

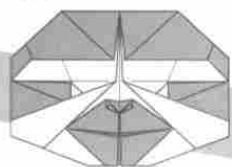

122

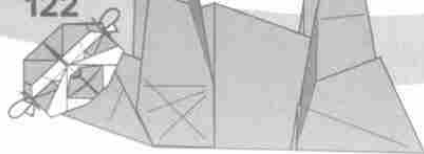

튀어나온 부분을 뒤로 접어주세요.

123



양쪽 다 뒤로 접어주세요.

124

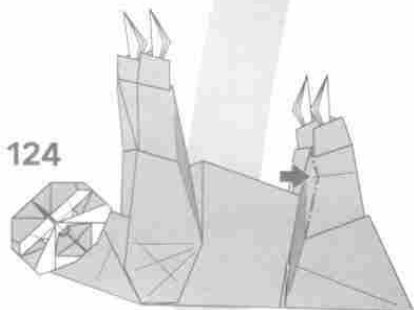

뒷다리를 다듬어주세요.

128

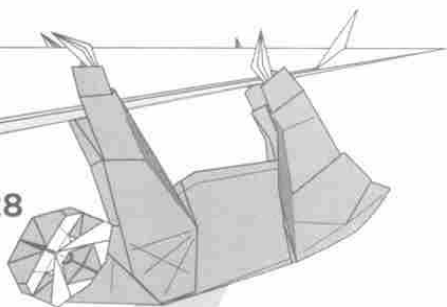

완성

125

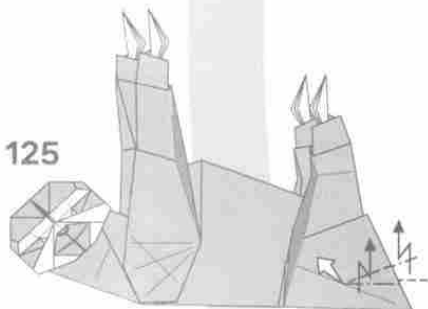

양쪽 계단잡기하면서 엉덩이를
동글게 다듬어주세요.

127

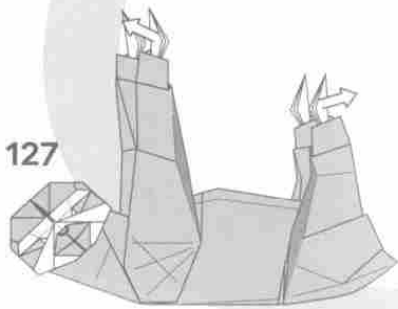

발톱 종이층을 벌려주세요.

126

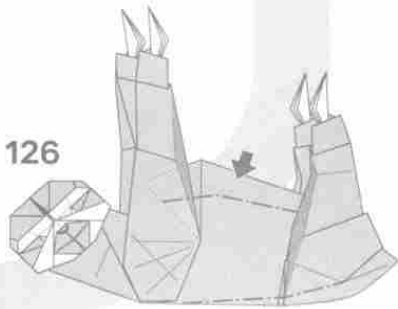

몸통을 다듬어주세요. ↑

호랑이 얼굴 Tiger mask

by Lee InSeop : Korea

Diagram by Lee InSeop

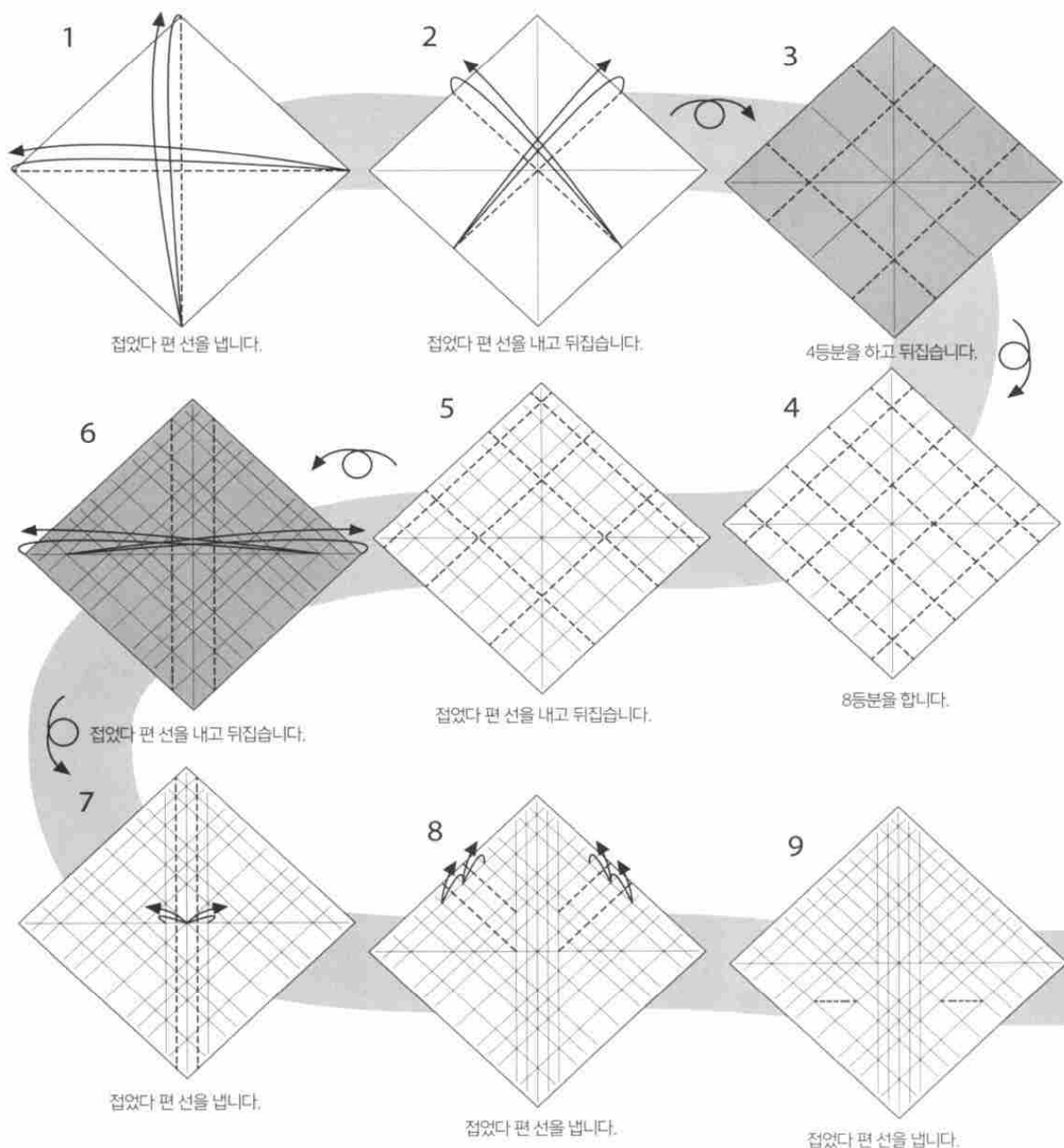
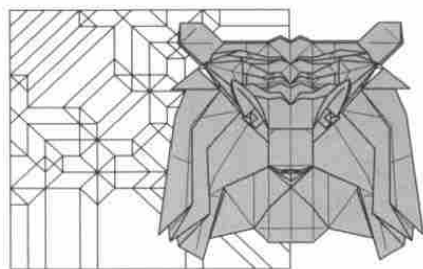

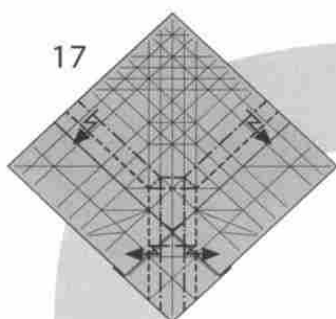

17

선대로 접습니다.

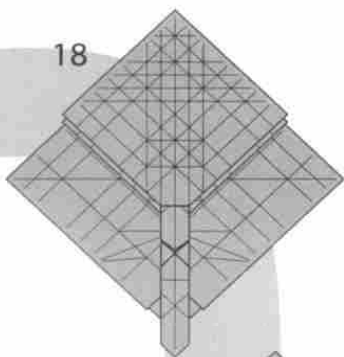

18

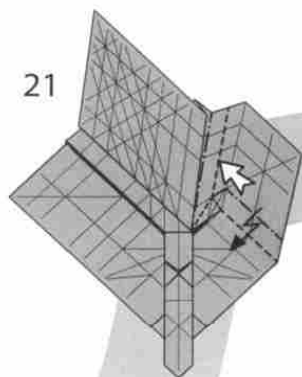

21

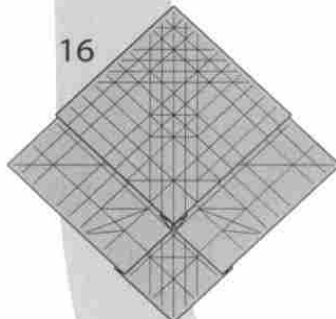

16

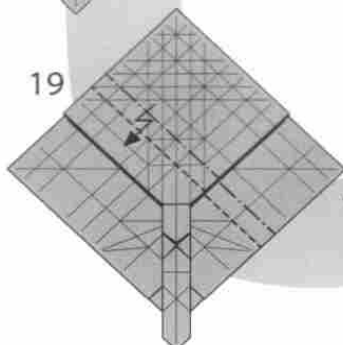

19

계단접기 합니다.

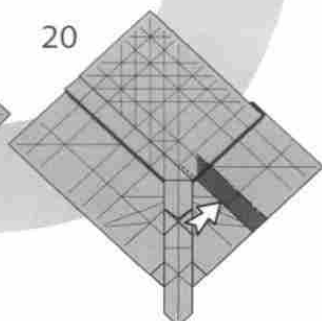

20

주름을 집어넣습니다.

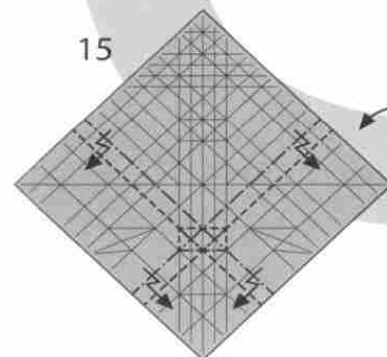

15

선대로 접습니다.

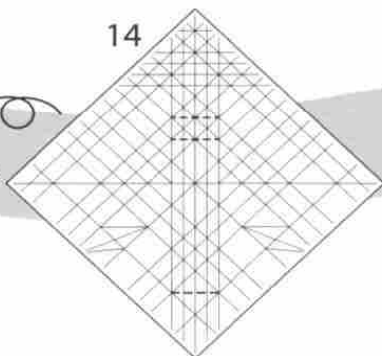

14

접었다 편 선을 내고 뒤집습니다.

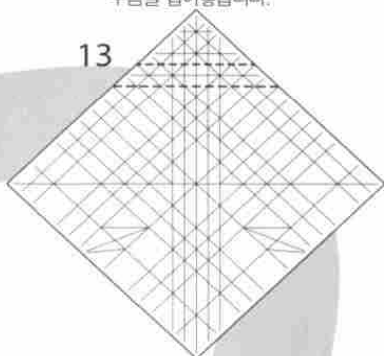

13

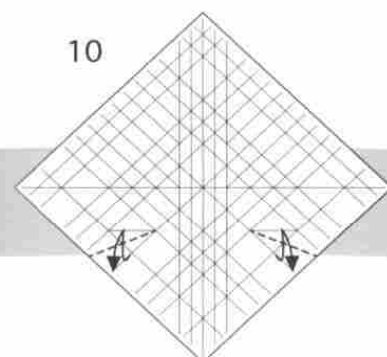

10

22.5도 선을 냅니다.

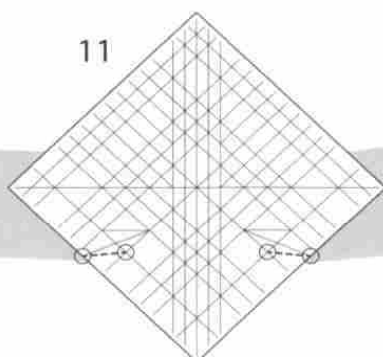

11

접었다 편 선을 냅니다.

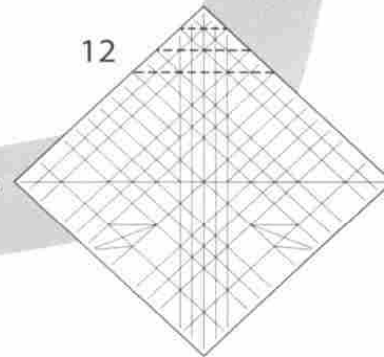

12

접었다 편 선을 냅니다.

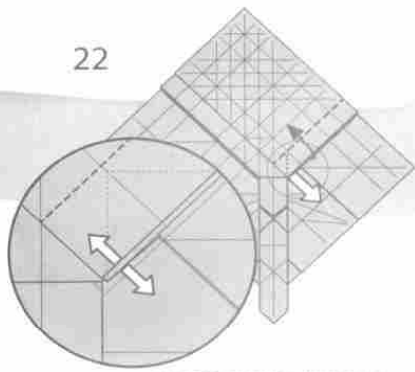

22

긴 주름을 잡아당겨 분리합니다.

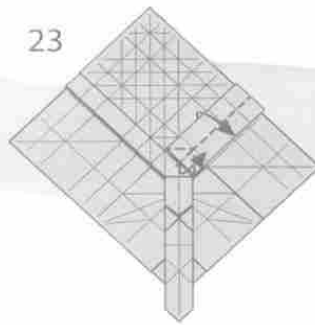

23

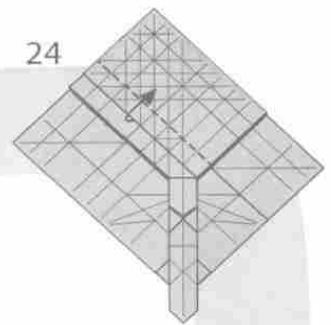

24

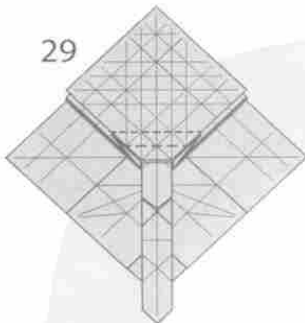

29

접었다 편 선을 냅니다.

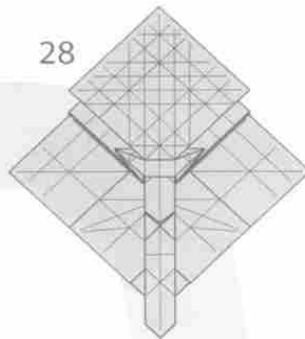

28

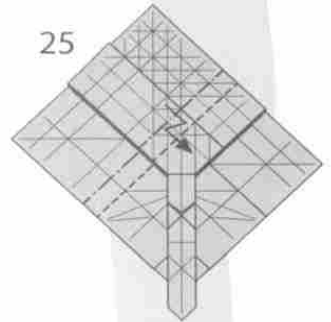

25

계단접기 합니다.

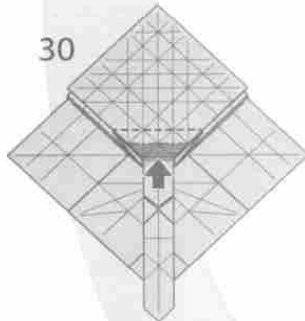

30

spread sink

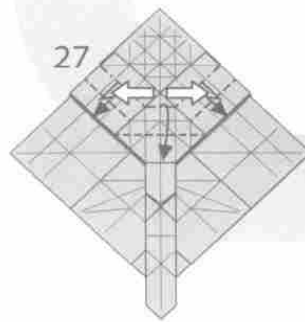

27

가운데 긴 주름을 펼치며 접습니다.

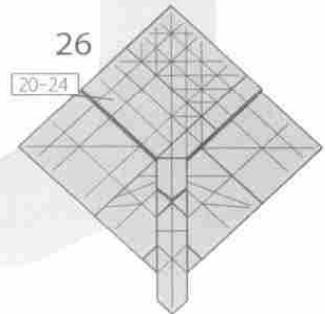

26

반대쪽도 20-24를 반복합니다.

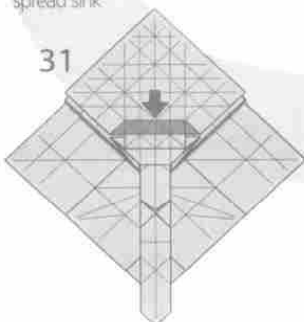

31

closed sink

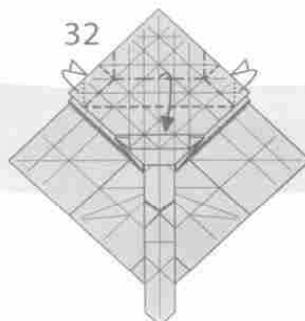

32

종이를 앞으로 넘기며 접습니다.

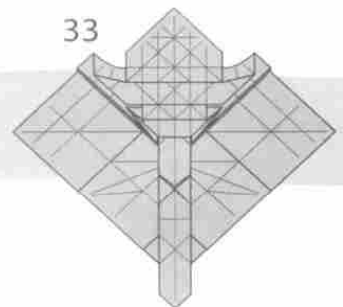

33

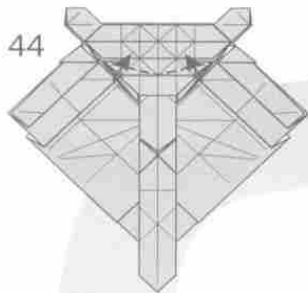

44

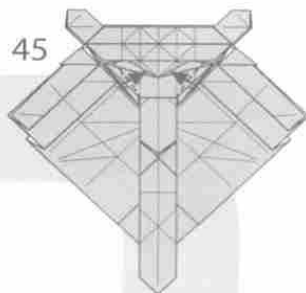

45

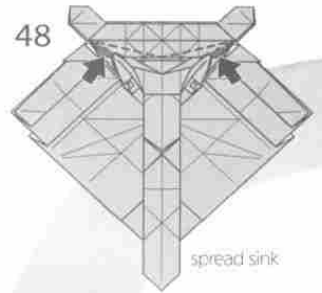

48

spread sink

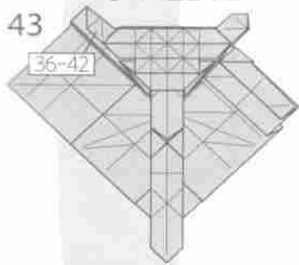

43

1장 위로 올립니다.

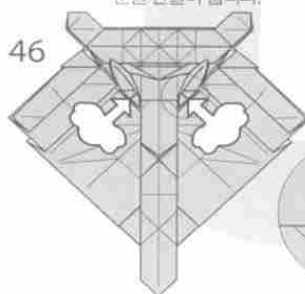

46

눈동자를 만들어 줍니다.

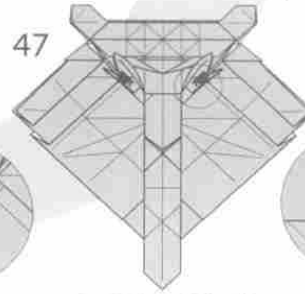

47

눈동자를 만들어 줍니다.

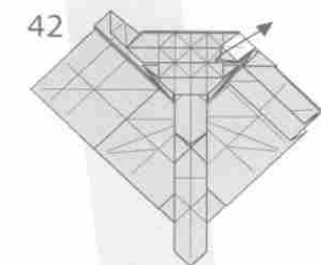

42

반대쪽도 36-42를 반복합니다.

각을 45도 꺾어 줍니다.

39

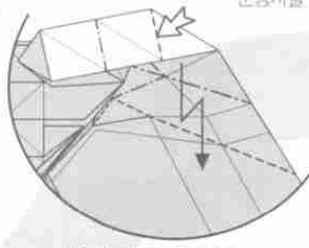

계단접기 하며 접습니다.

38

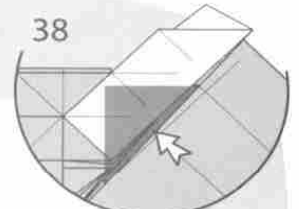

45도 선을 내며 펼칩니다.



41

귀를 다시 펼칩니다.

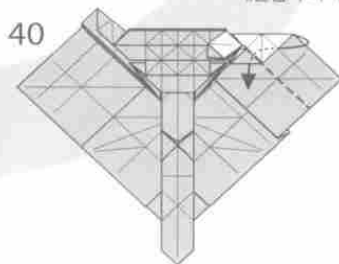

40

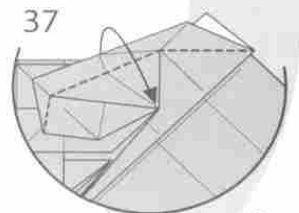

37

레이어를 맞습니다.

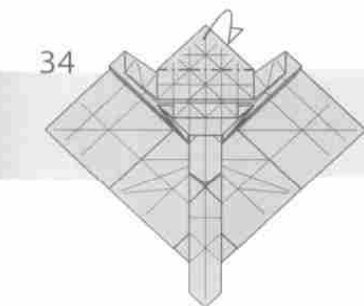

34

뒤로 넘깁니다.

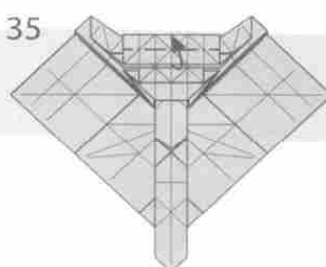

35

1장 위로 접습니다.

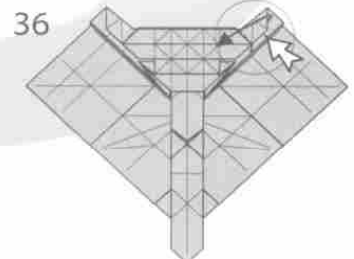

36

펼쳐 누르며 접습니다.

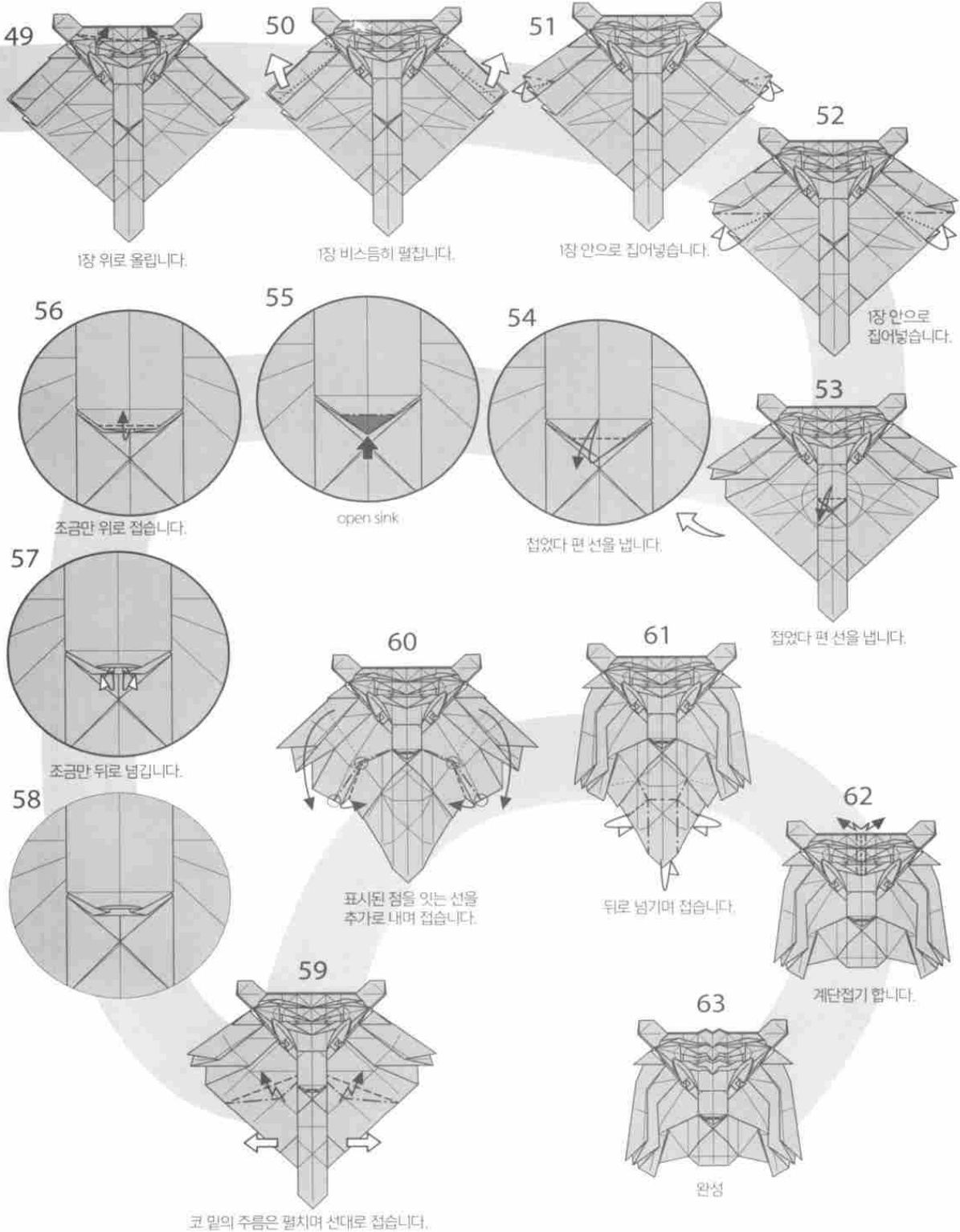

Asian tapir

by Tai His Min : Taiwan

Diagram by Tai His Min

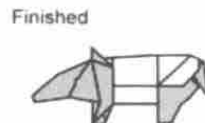
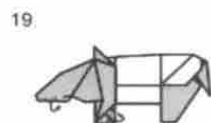
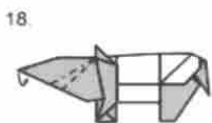
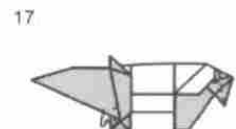
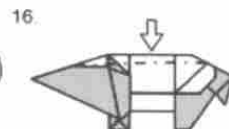
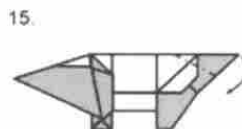
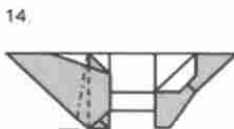
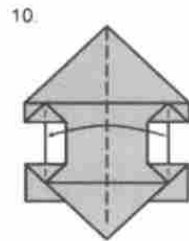
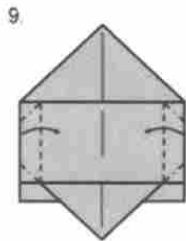
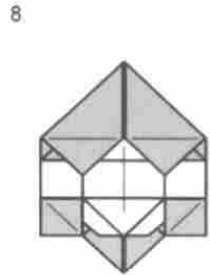
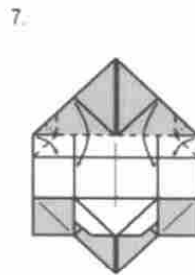
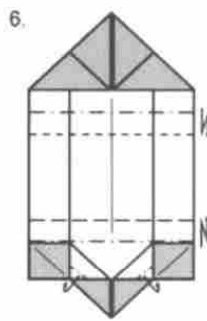
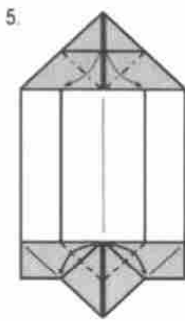
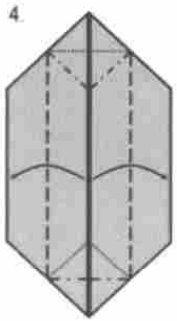
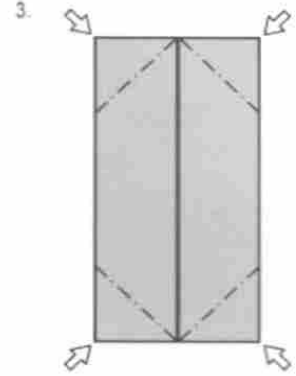
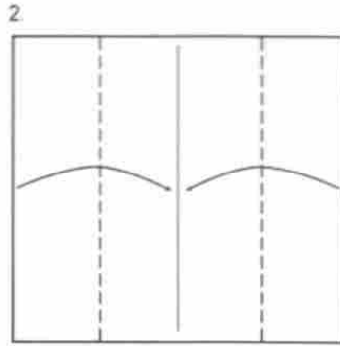
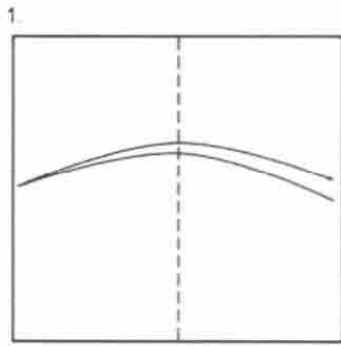
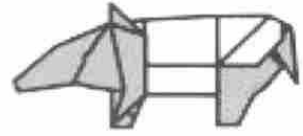

앉아있는 고양이 Sitting Cat

by Oriol Esteve : Spain

Diagram by Oriol Esteve

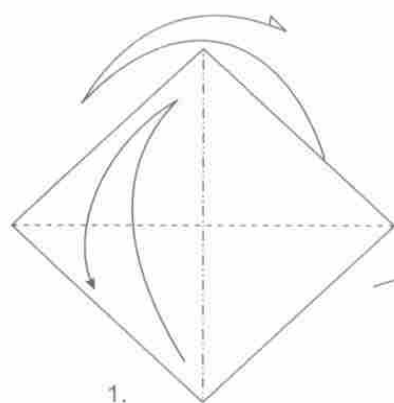
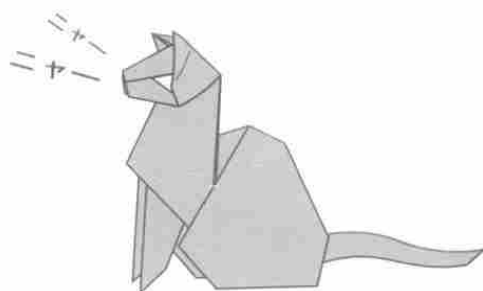

1.

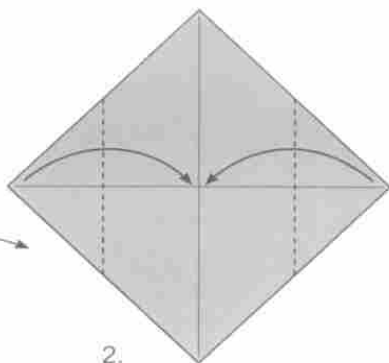

2.

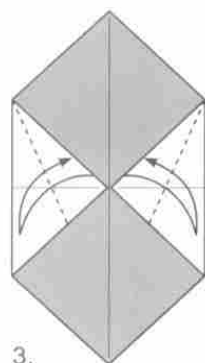

3.

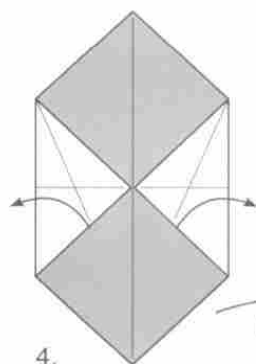

4.

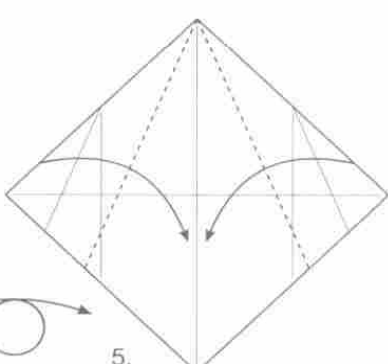

5.

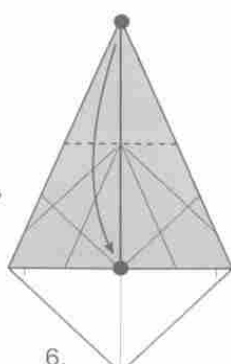

6.

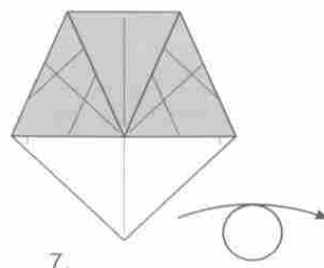

7.

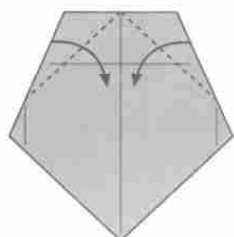

8.

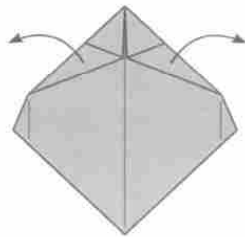

9.

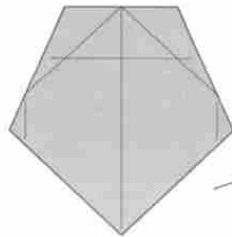

10.

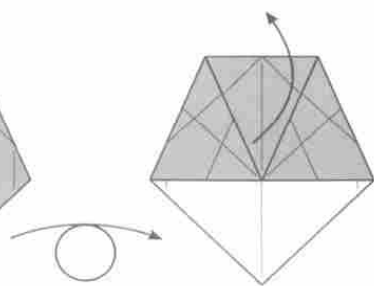

11.

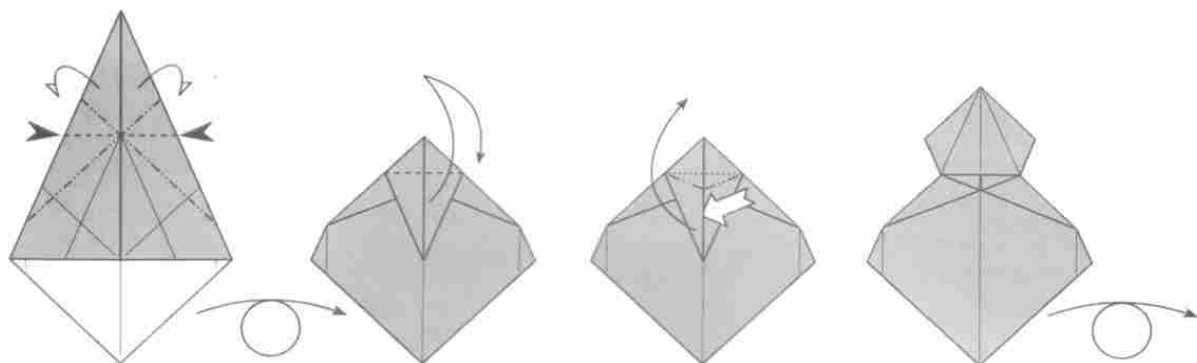

12. Central point is folded like a water-bomb base.

El punto central se pliega como una base bomba de agua.

13.

14.

15.

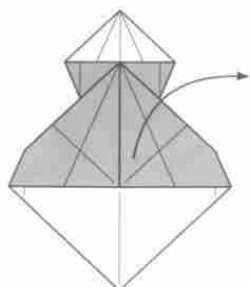

16. Open the flap: just half way.

Abrir la solapa: a medio recorrido.

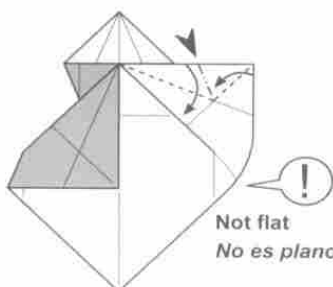

17. Start a rabbit-ear fold...

Empezar una oreja de conejo...

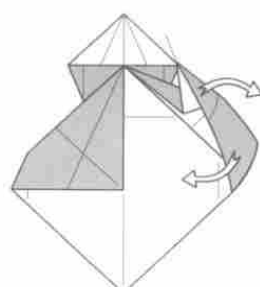

18. Rotate the flap, do not flatten it.

Rotar el triángulo menor y cambiar el perfil del borde.

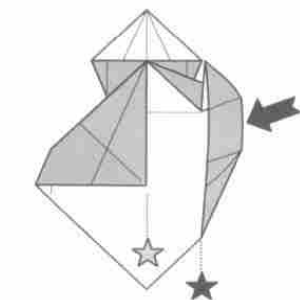

19. Squash so that the two vertical edges indicated by the stars are parallel.

Aplastar, manteniendo paralelos los dos bordes señalados.

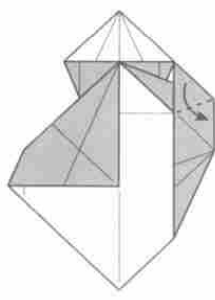

20.

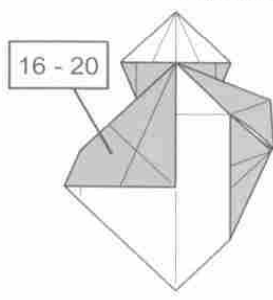

21.

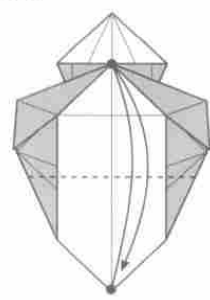

22. Join the two spots and unfold.

Junter los dos puntos, marcar y deshacer.

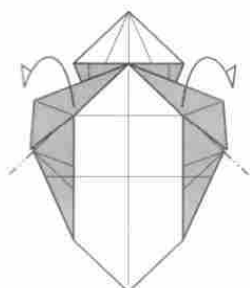

23.

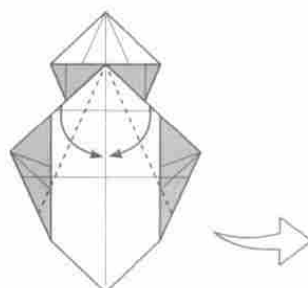

24. Edges to the middle.

Los bordes van al centro.

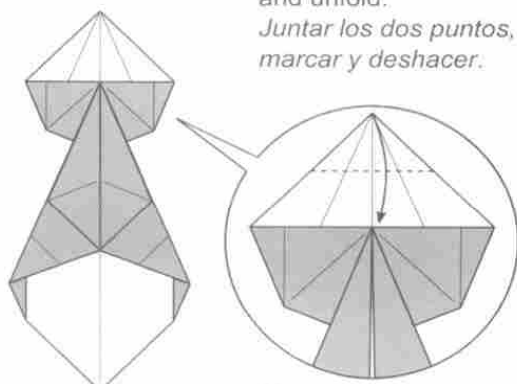

25.

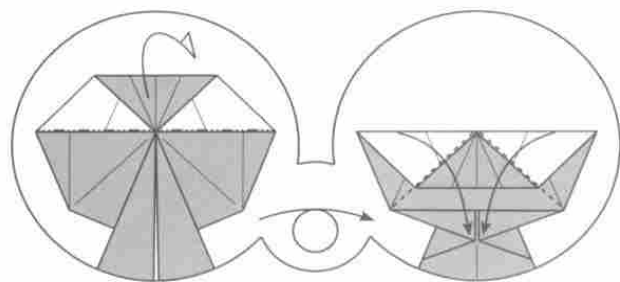

26.

27.

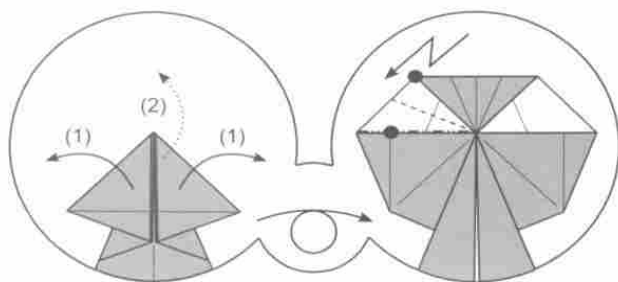

28. Unfold the last two steps.

29.

Deshacer los dos últimos pasos.

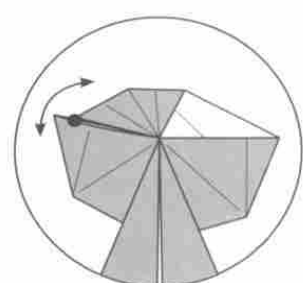

30. Unfold.
Deshacer.

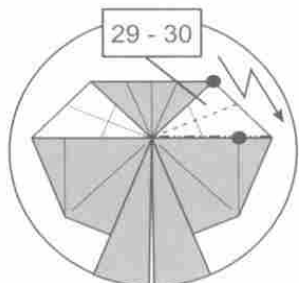

31.

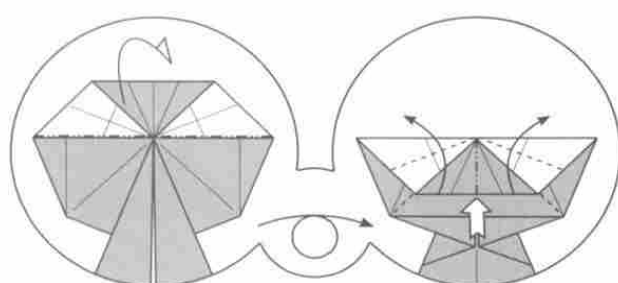

32.

33. Lift, repeating pleats.
Usar los pliegues y elevar.

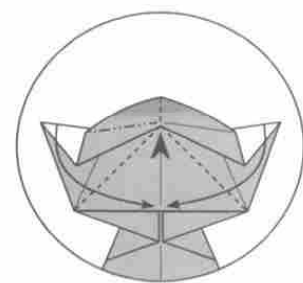

34. Central layer is trapped between flaps.
La capa central queda atrapada entre las solapas.

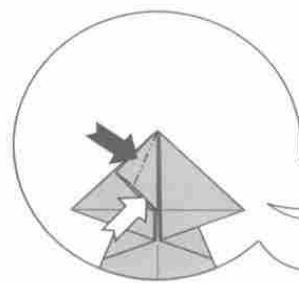

35. Open and squash.
Abrir y aplastar.

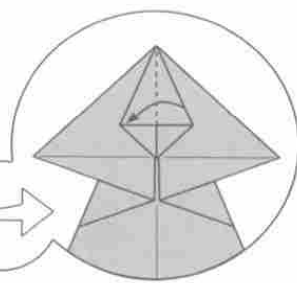

36. Fold to the left to work on the flap.

Pasar al otro lado para trabajar cómodamente la solapa.

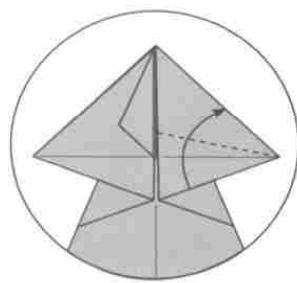

37.

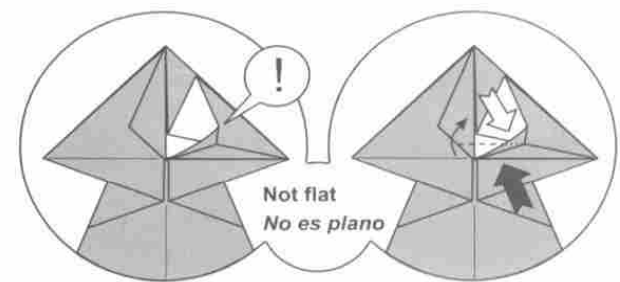

38. To flat the inner flap, adjust horizontally and squash to the front.
Ajustar la pestaña interior en horizontal y aplastar hacia adelante.

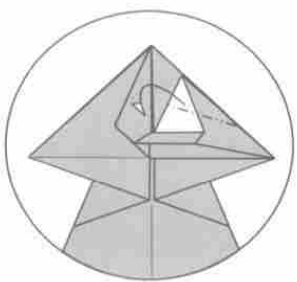

39. Arbitrary angle.
Ángulo arbitrario.

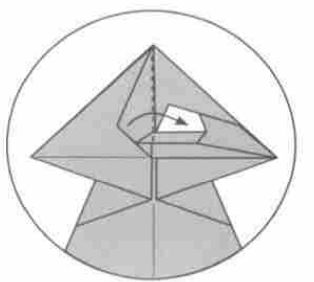

40. Top flap folds back.
La capa de encima vuelve a su sitio.

36 - 40

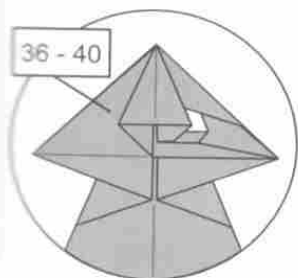

41.

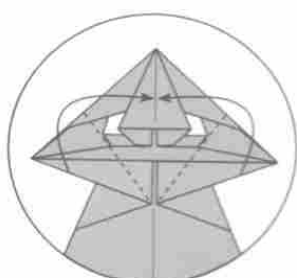

42. Bring lower edges to the middle.
Llevar los bordes inferiores al centro.

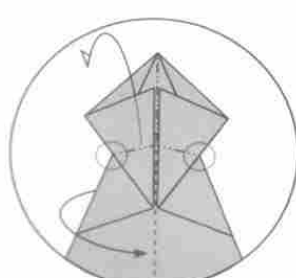

43. Close the model, reversing the head from the shown references.
Cerrar el modelo, invirtiendo la cabeza desde las referencias que se muestran.

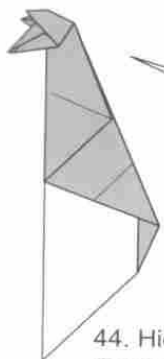
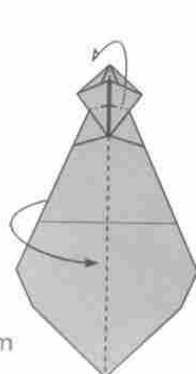

44. Hide about one third of the reversed tip.
Esconder alrededor de un tercio de la punta invertida.

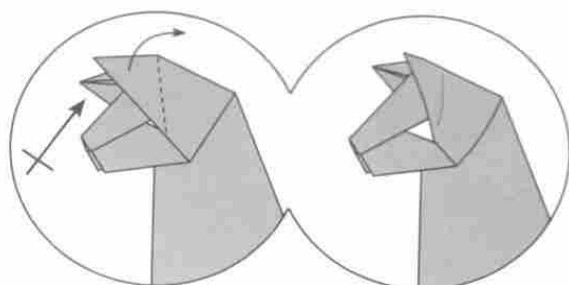
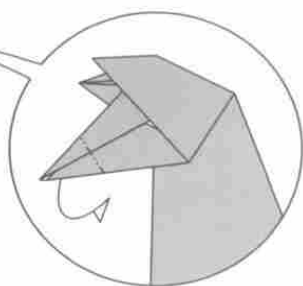

45. Fold the ears halfway to make the eyes more visible.
Plegar para entreabrir la oreja. Solo para que el ojo sea más visible.

46. Use the existing crease to inside-reverse-fold the body.
Usar la marca existente para hacer un invertido interior del cuerpo.

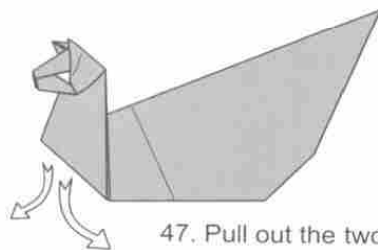
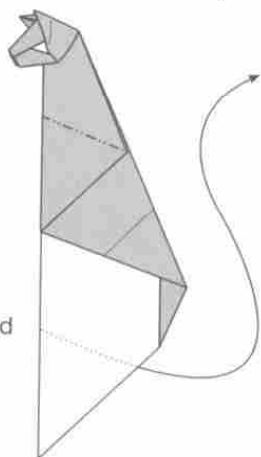

47. Pull out the two inner triangles, following two conditions...
Sacar los triángulos interiores, siguiendo dos condiciones...

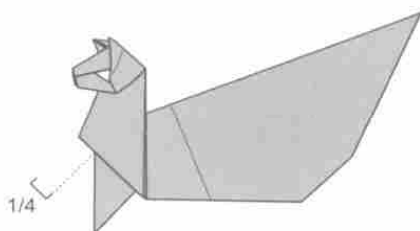

(47.1)
...leave a gap, around a quarter of the side.
...dejar un cuarto del espacio del borde libre.

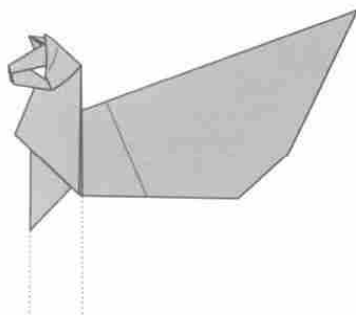

(47.2)
...these two sides must be parallel.
...estos dos lados deben ser paralelos.

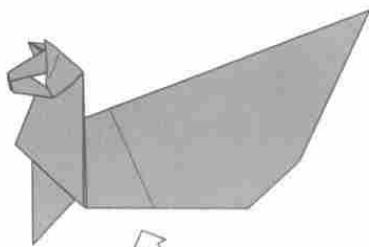

48. Open.
Abrir.

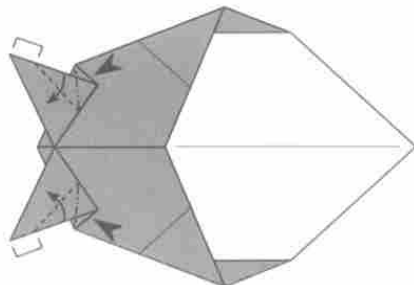

49. Arbitrary swivel to narrow. Leave a gap before tip.
Hacer un "swivel" al gusto. No llegar a la punta.

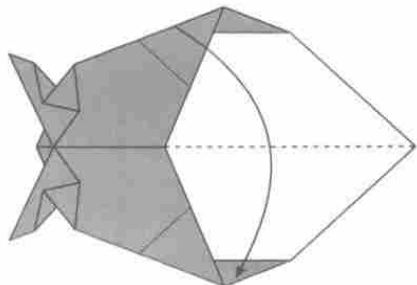

50. Close.
Cerrar.

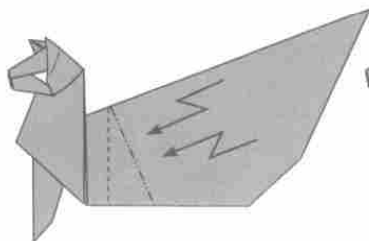

51. Use the existing mountain crease for a crimp.
The new corner reaches (or slightly overlaps) the front leg.
Usar la marca en monte ya existente para un "crimp".
La nueva esquina llega (o cubre un poco) la pata delantera.

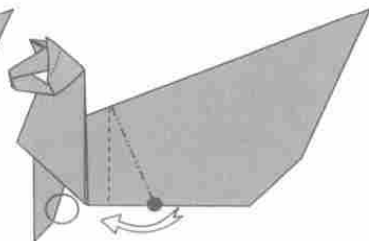

52. Choose the final orientation and form a base. Leave a gap at the end of the tail.
Definir la orientación del modelo y proyectar una base. No llegar a la punta de la cola.

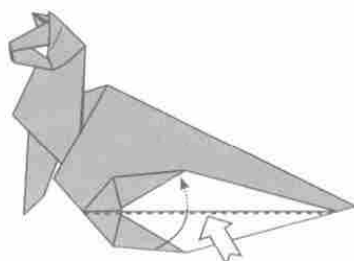
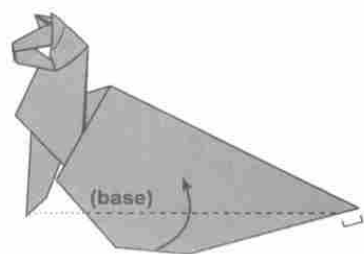

53. Hide inside.
Esconder dentro.

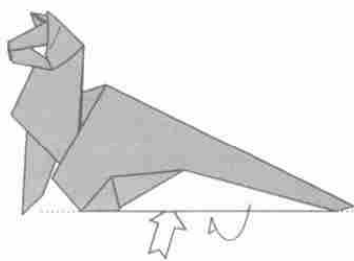

54. Flip to hide inside.
Voltear para esconder dentro.



55. Inside reverse fold.
Invertido interior.

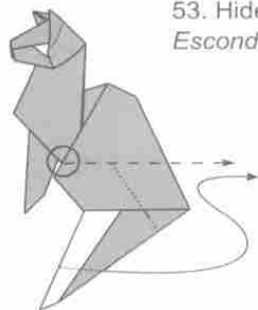

56. Project the position of the tail and reverse.
Proyectar la posición de la cola e invertir.

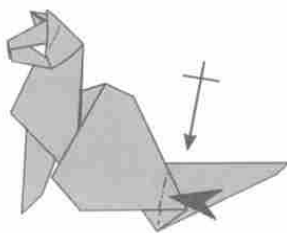

57. Arbitrary angle.
Ángulo arbitrario.

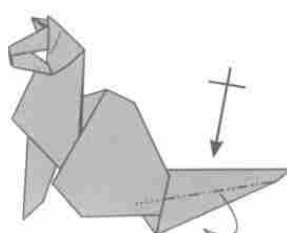

58.

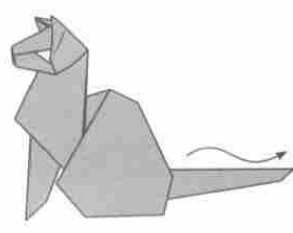

59. Shape.
Modelar.

Done!

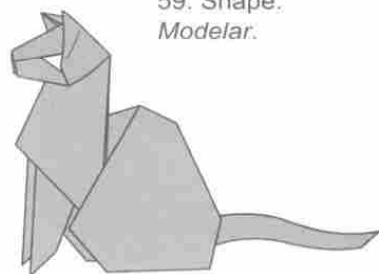

펭귄 Penguin

by Gen Hagiwara : Japan

Diagram by Gen Hagiwara

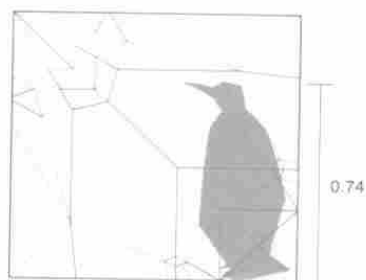
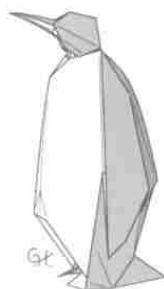

1

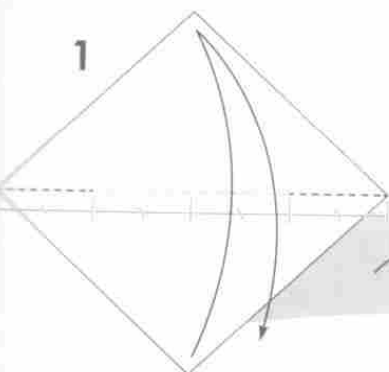

対角線に折り筋をつける
真ん中 2/4 ほどは折らない
Fold in half and unfold.
Fold only 1/4 from each corner.

2

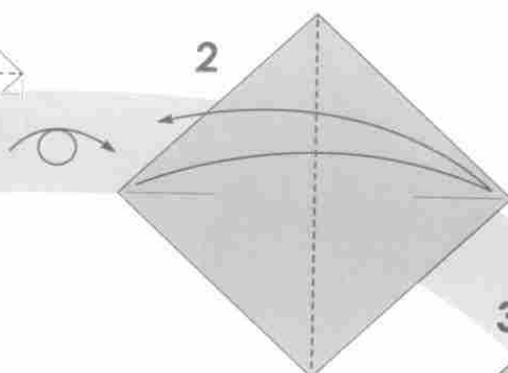

対角線に折り筋をつける
Fold in half and unfold.

3

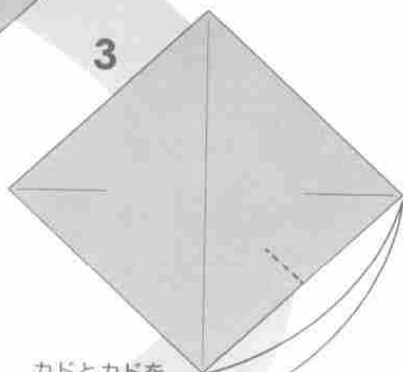

カドとカドを
合わせて印をつける
Fold the corner to the
corner and make a mark.

5

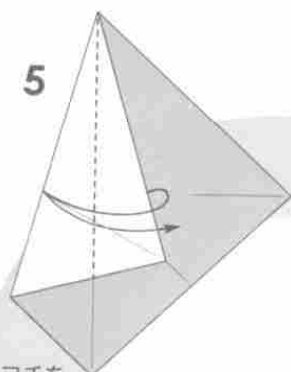

フチとフチを
合わせて折り筋をつける
Fold the edge to the edge
and unfold.

4

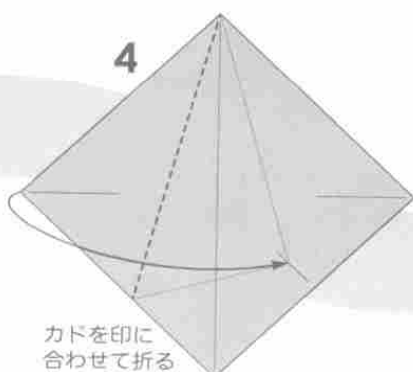

カドを印に
合わせて折る
Fold the corner
onto the mark.

6

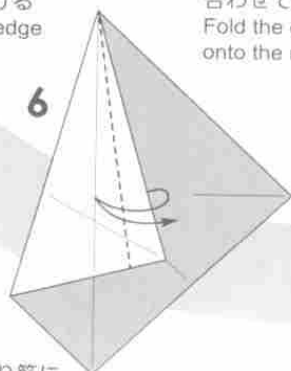

フチを折り筋に
合わせて折り筋をつける
Fold the edge to the crease
line and unfold.

7

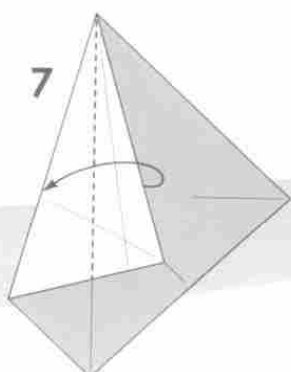

折り筋で折る
Fold at the crease line.

8

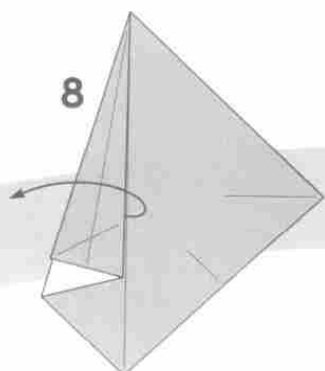

4で折ったところを戻す
Unfold the fold done in the step 4.

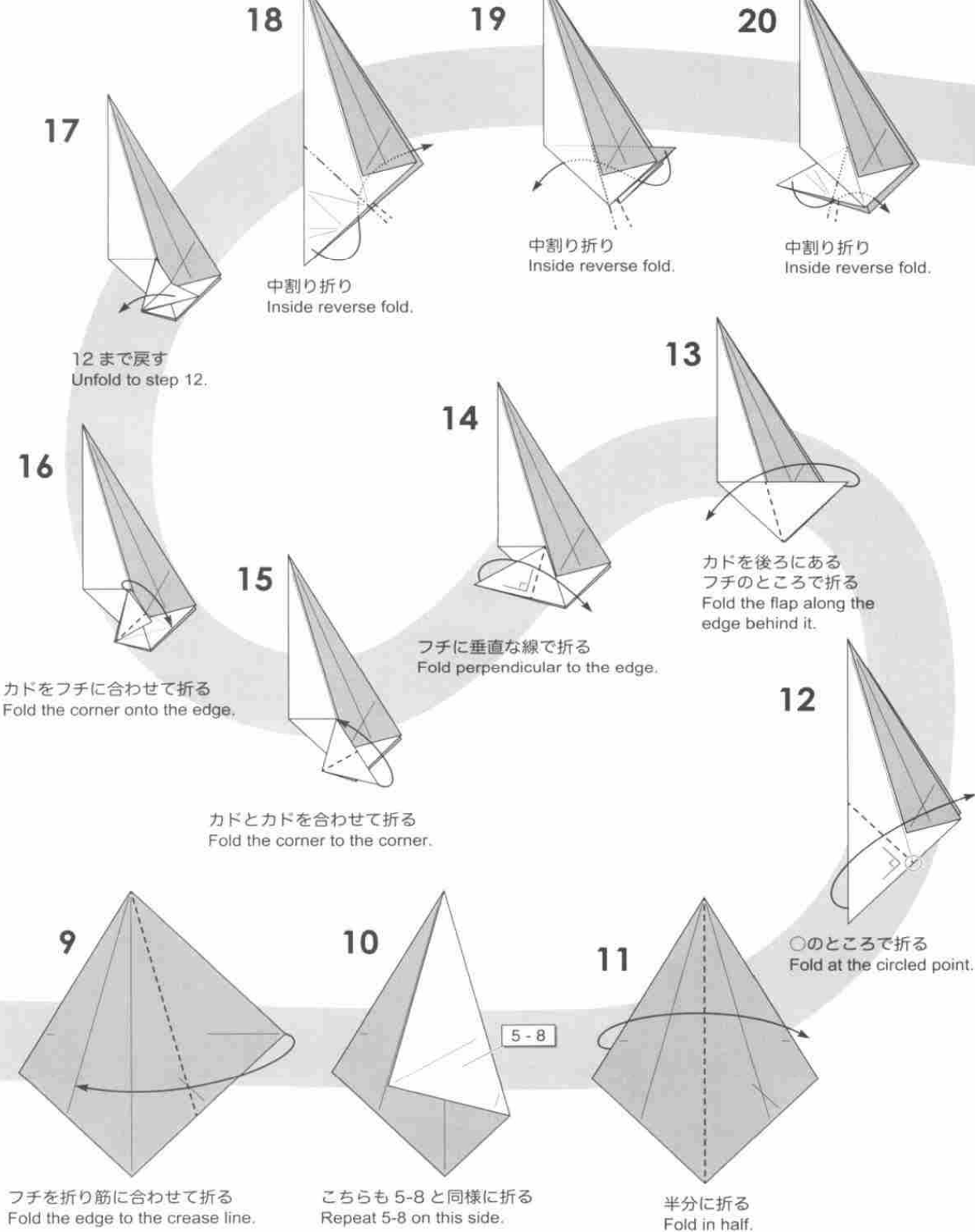

21

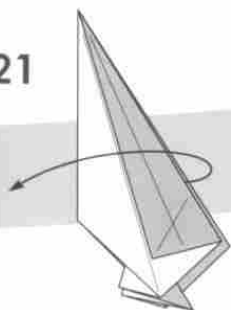

開く
Open.

22

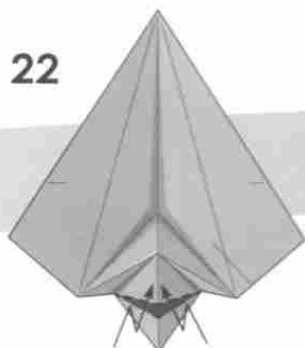

ついている折り筋で
両側で斜めに段折り
Crimp.

23

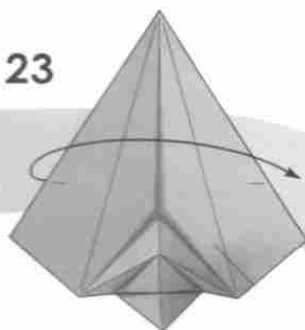

閉じる
Close.

24

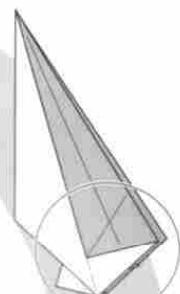

25

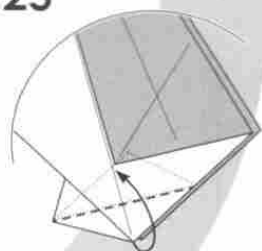

カドを後ろに
あるフチのところで折る
Fold along the hidden edge.

28

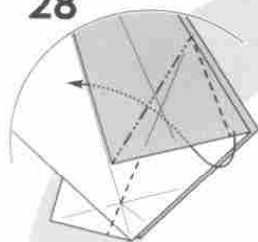

ついている折り筋で中割り折り
Inside reverse fold.

27

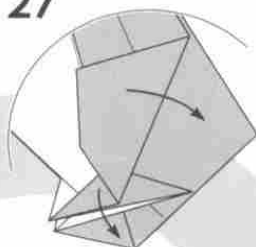

28 まで戻す
Unfold to step 28.

26

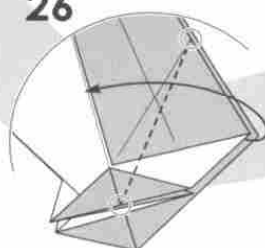

○と○を結ぶ線でカドを折る
Fold along the line connecting
the circled points.

29

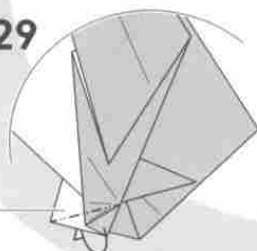

裏側
Back side

カドをフチのところで内側へ折る
カドの先は隙間に差し込む
Fold at the edge.
Insert the corner in to the slit.

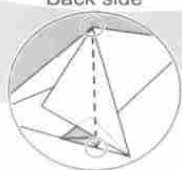
裏側
Back side

○を結ぶ線でカドを内側へ折る
Fold the corner inside along the
line connecting the circled points.

30

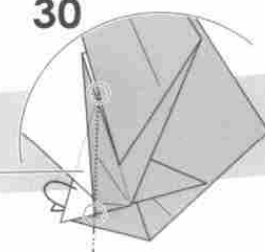

31

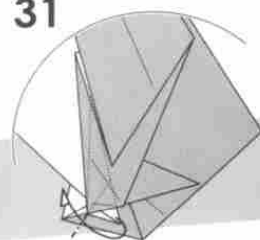

カドを折る
角度は次の図を参照
Fold the corner out.
Refer to the next step
for the angle.

40

半分の角度で中割り折り
Inside reverse fold at the angle bisector.

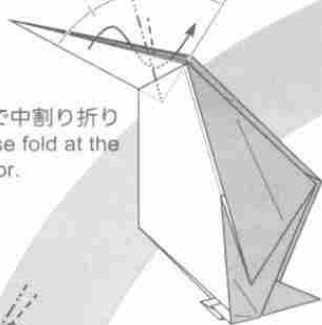

41

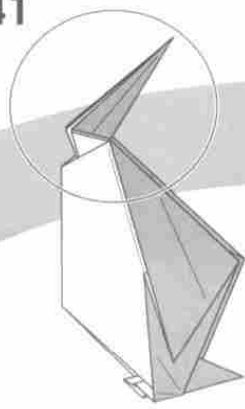

42

カドを折って折り筋をつける
Fold and unfold.

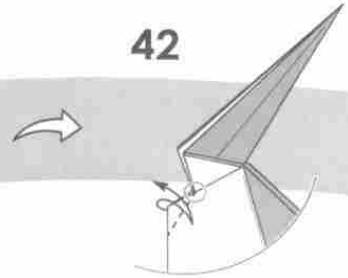

39

目一杯のところまで中割り折り
Inside reverse fold.

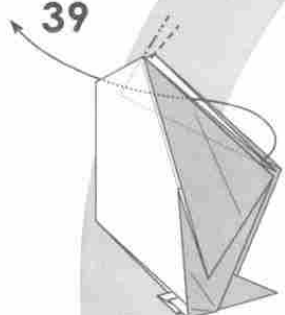

36

○を結ぶ線で折り筋をつける
Fold along the line connecting the circled points and unfold.

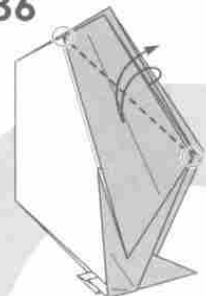

35

中割り折り
Inside reverse fold.

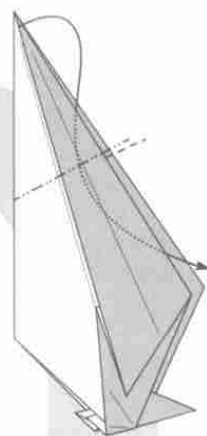

38

反対側も 36-37 と同様に折る
Repeat 36-37 on the other side.

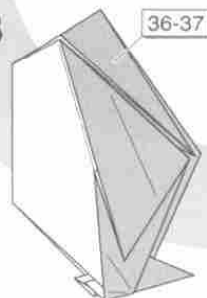

36-37

37

中割り折り
Inside reverse fold.

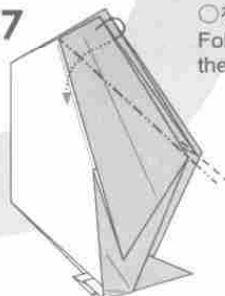

34

カドとカドを
合わせて折り筋をつける
Fold the corner to the corner.

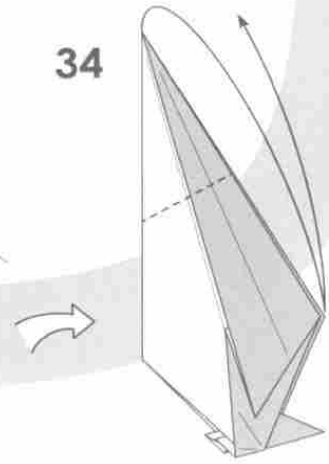

32

これらのフチが
並行になる様にする
Make these
edges parallel.

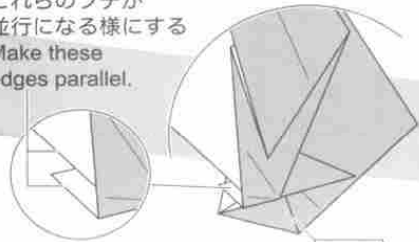

25-31

反対側も 25-31 と同様に折る
Repeat 25-31 on the other side.

33

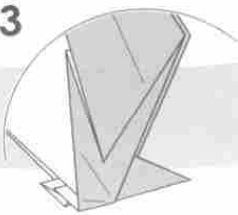

43

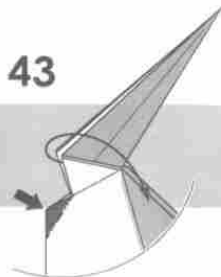

真ん中の隙間を広げながら
折り筋を使ってカドを潰す
Open the layers at the middle
and squash the corner.

44

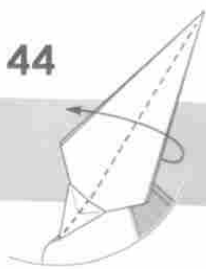

閉じる
Close.

45

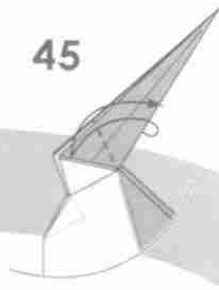

フチとフチを
合わせて折り筋をつける
Fold the edge to the edge
and unfold.

46

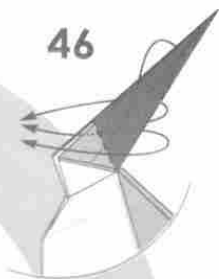

折り筋を使ってかぶせ折りと
中割り折りを同時に行なう
Outside and inside reverse fold.

50

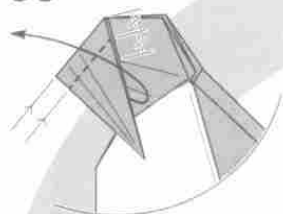

図の様にカドを折る
Fold as shown.

49

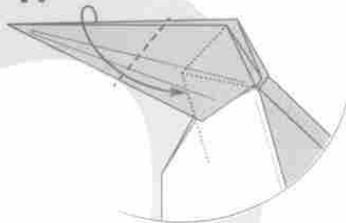

フチの中にあるフチに合わせて折る
Fold the edge to the hidden edge.

47

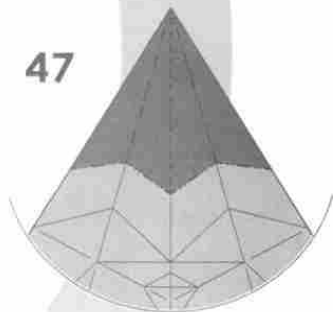

46を広げてみたところ
Crease pattern for the step 46.

51

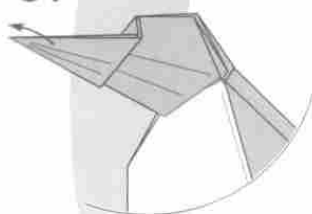

カドを戻す
Unfold.

48

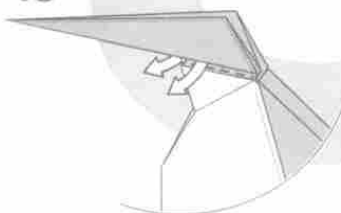

内側から紙を引き出す
Pull out the inner layer.

52

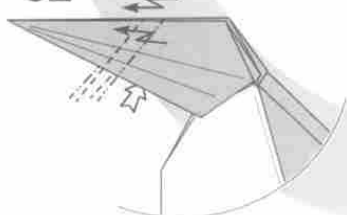

下側の隙間を開いて両側で段折り
隙間は2つあるがどちらでも良い
Open the layers from bottom and crimp.
There are two pockets could
be used but either is fine.

53

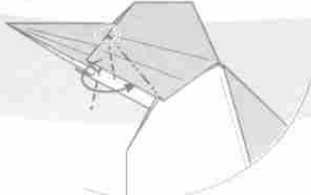

内側へ引き寄せる様に折る
Inside swivel fold.

54

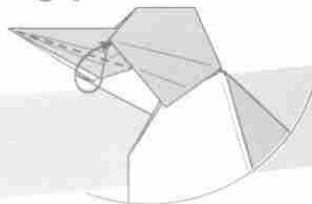

カドを折る
折ったカドの先端は隙間に入れる
Fold the corner.
Insert the tip of the corner
between the layers.

61

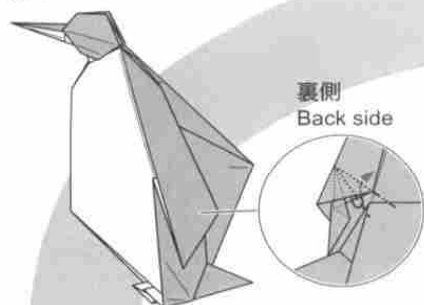
裏側
Back side紙をずらす様に折る
Swivel the layers.

62

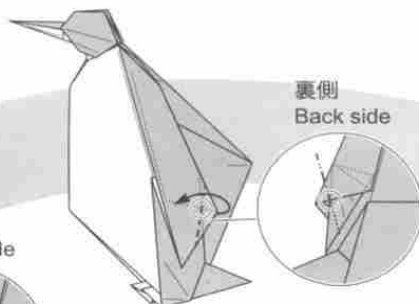
裏側
Back sideカドを○を通るところで折る
Fold the corner at the circled point.

63

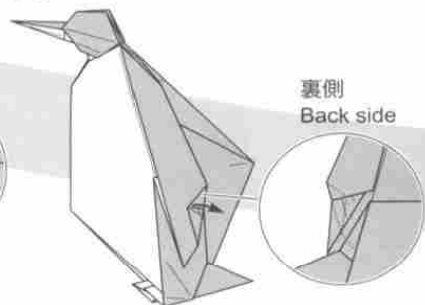
裏側
Back side戻す
Unfold.

60

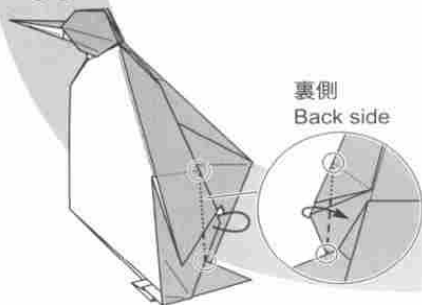
裏側
Back side○と○を結ぶ線で内側へ折る
Fold the corner behind along the
line connecting the circled points.

59

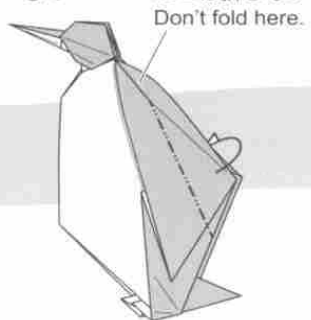
ここは折らない
Don't fold here.ついている
折り筋でフチを内側へ折る
Fold the edge behind at
the existing crease line.

58

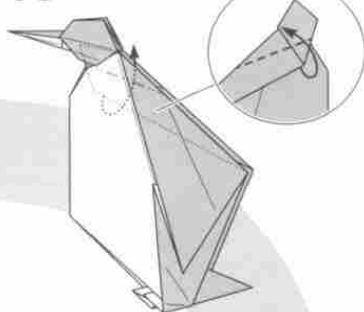
裏側
Back side内側にあるフチを
ついている折り筋のところで折る
Fold the inner layer
at the existing crease line.

55

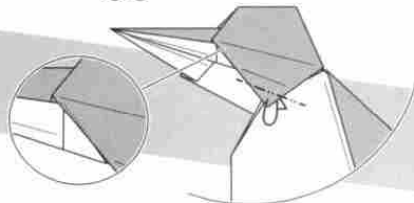
カドを内側へ折る
Fold the corner inside.

56

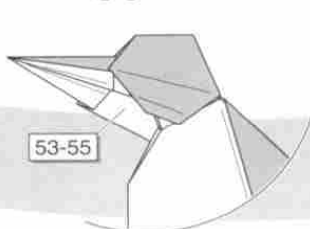
反対側も 53-55 と同様に折る
Repeat 53-55 on the other side.

57

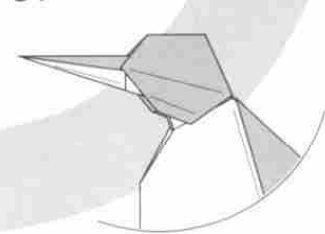

64

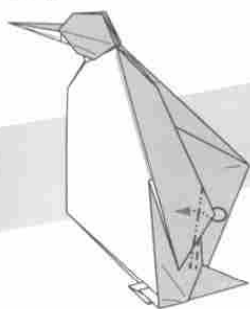

ついている
折り筋で中割り折り
Inside reverse fold.

65

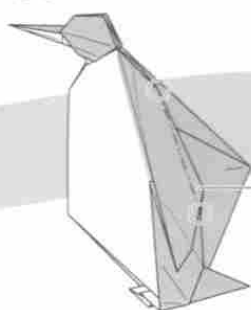

○と○を結ぶ線で折ってフチを起こす
Fold along the line connecting the
circled points and raise the edge.

裏側
Back side

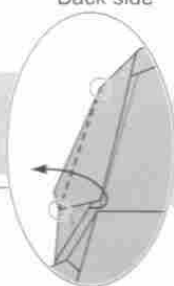

66

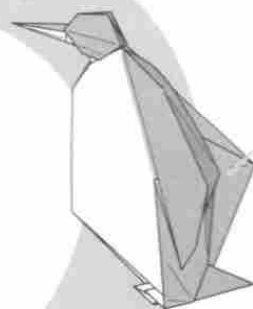

58-65

反対側も 58-65 と同様に折る
Repeat 58-65 on the other side.

68

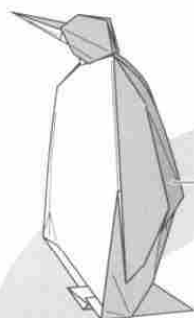

形を整える
Refine the shaping.

背側
View from backside

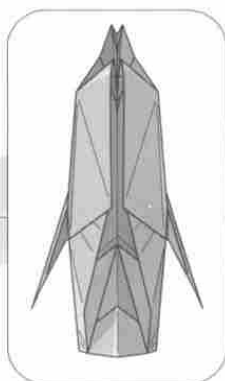

67

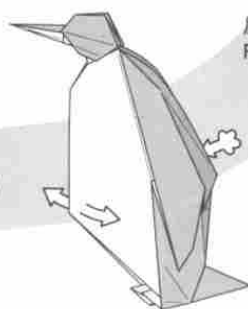

腹部を膨らませて丸みをつける
Puff up the belly
and make the body round.

69

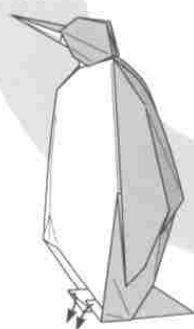

足を内側へ倒して接地する様にする
Make the feet touch the ground.

70



くちばしを軽く曲げる
Give a slight curve to the beak.

71

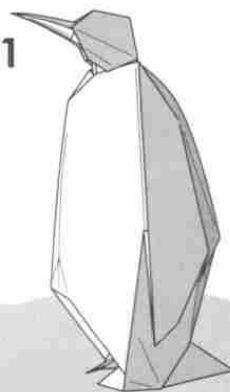

できあがり
Model completed.

Hatching Dragon

by Junior Javier Vivanco Garcia : Peru

Diagram by Junior Javier Vivanco Garcia

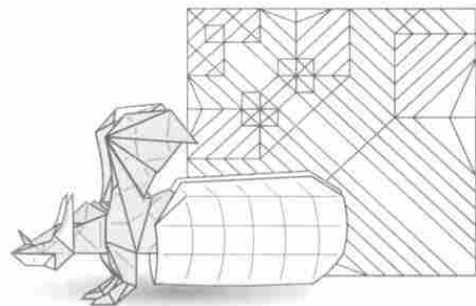

1

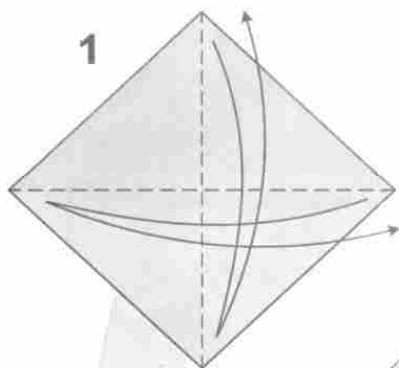

Fold and unfold.

2

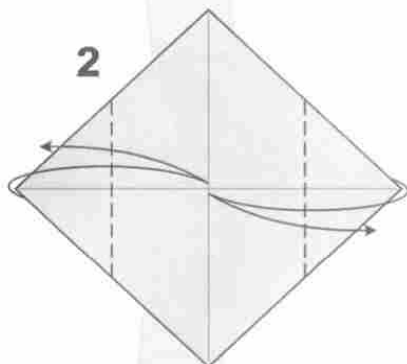

Fold and unfold to the center.

3

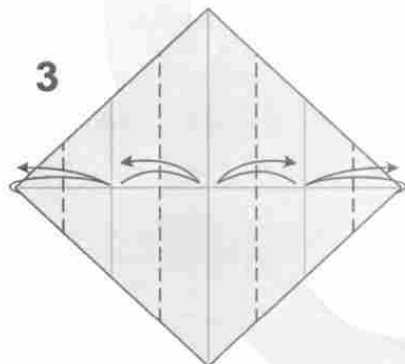

Fold and unfold.

4

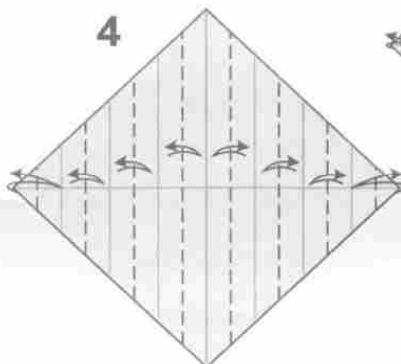

Fold and unfold.

7

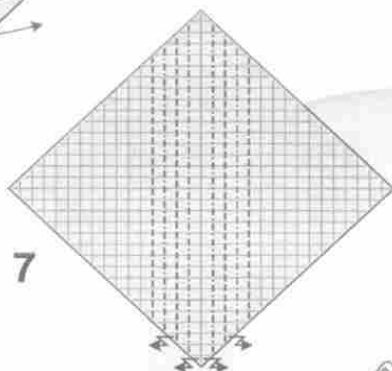

Pleat fold.

8

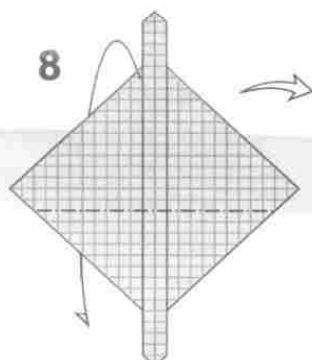

Mountain fold.

6

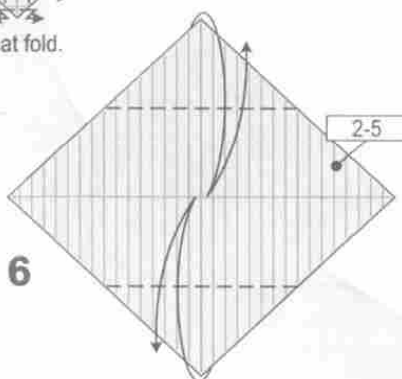

Repeat the steps 2-5.

5

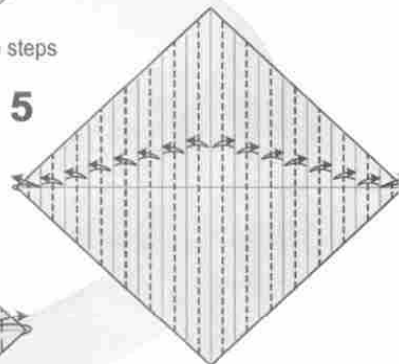

Fold and unfold.

10

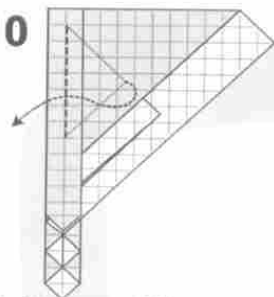

Inside reverse fold.

11

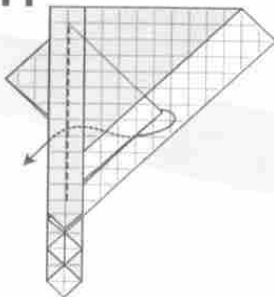

Inside reverse fold.

12

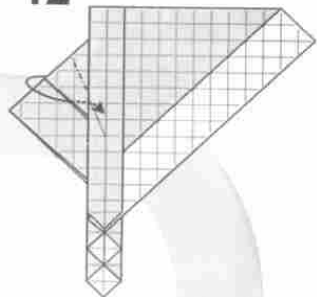

Inside reverse fold.

9

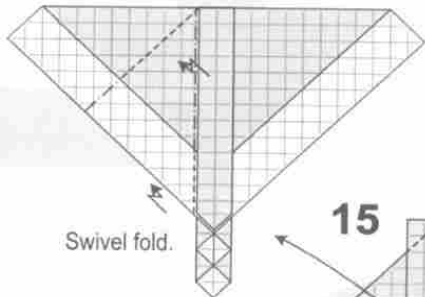

Swivel fold.

15

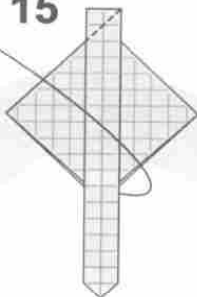

Open in valley fold.

14

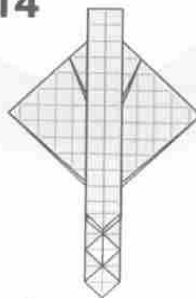

Turn paper over.

13

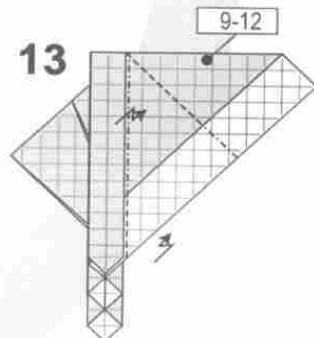

Repeat the steps 9-12.

16

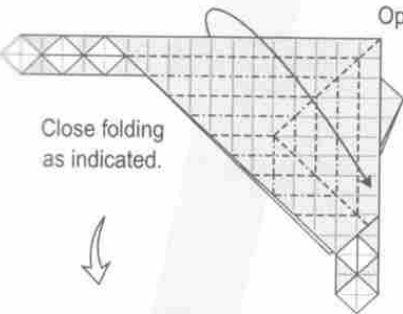

Close folding as indicated.

18



Open.

19

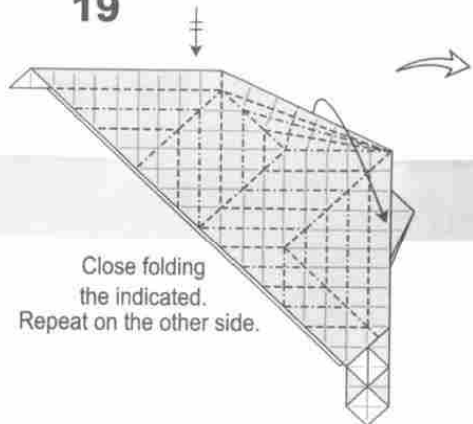

Close folding the indicated. Repeat on the other side.

17

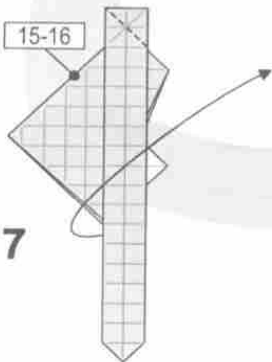

Repeat the steps 15-16.

29

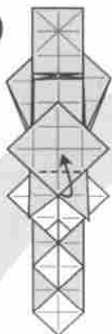

Valley fold.

30



Fold according to the lines.

31

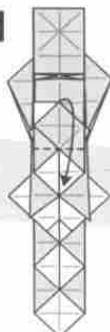

Valley fold.

32



Turn paper over.

28

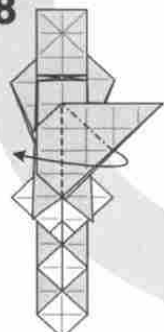

Squash fold.

27



Push folding as indicated.

26



Open sink.

25

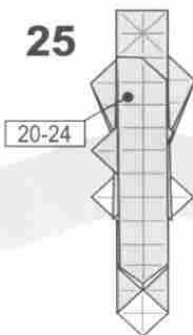

Repeat the steps 20-24.

24

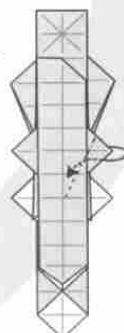

Inside reverse fold.

20

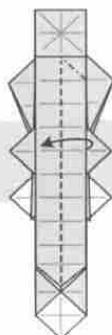

Valley fold.

21

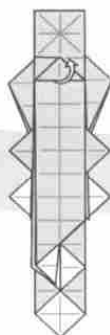

Pull out paper.

22

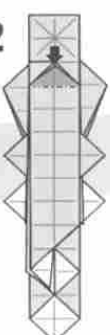

Open sink.

23

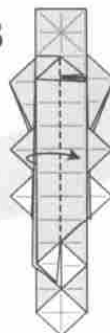

Valley fold.

33

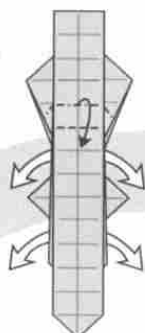

Open and fold as indicated in step 34.

34

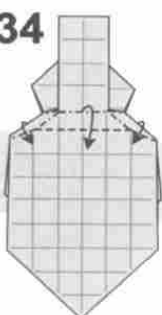

Step 33 in progress.

35

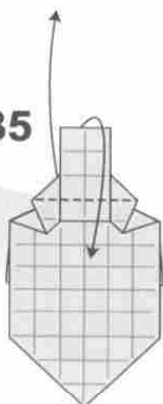

Valley fold.

36

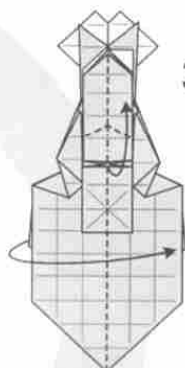

Close folding with the lines indicated.

38

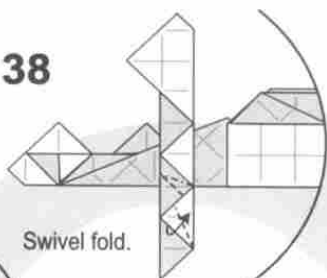

Swivel fold.

37

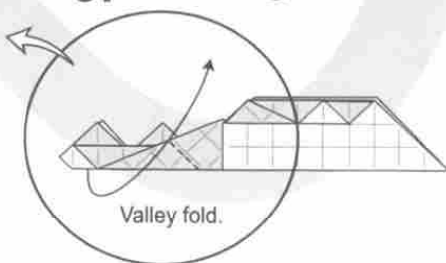

Valley fold.

39

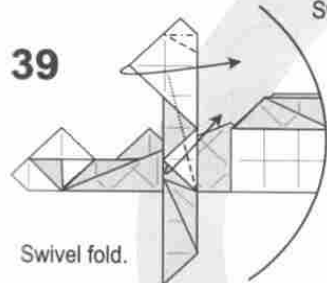

Swivel fold.

40

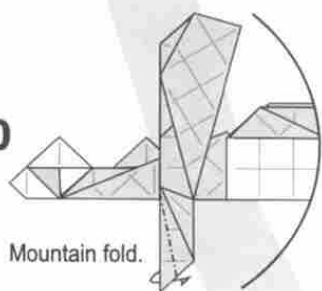

Mountain fold.

43

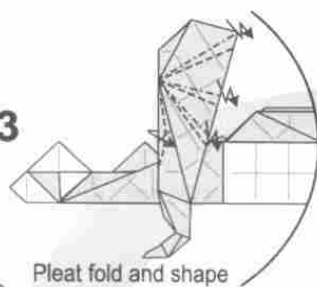

Pleat fold and shape the wings.

41

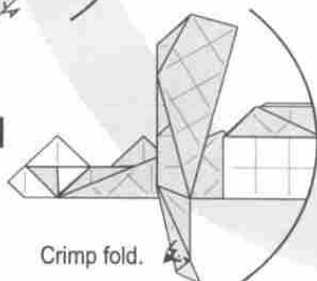

Crimp fold.

42

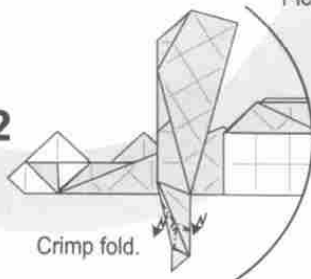

Crimp fold.

52

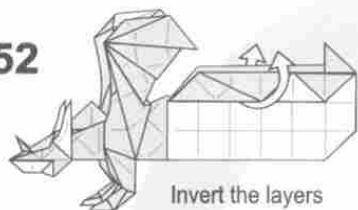

Invert the layers on both sides.

53

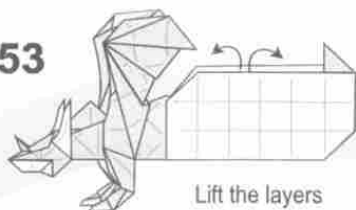

Lift the layers on both sides.

54

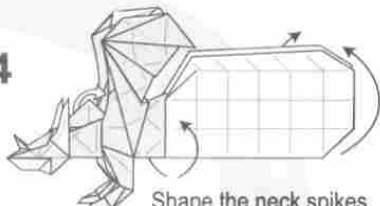

Shape the neck spikes and egg model in 3D.

51

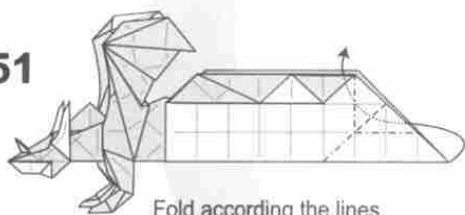

Fold according the lines.

55

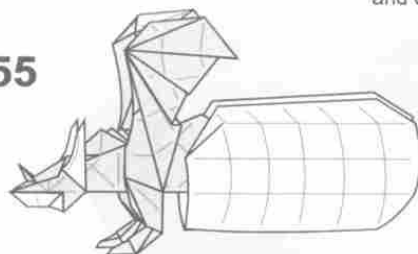

Model finished.

50

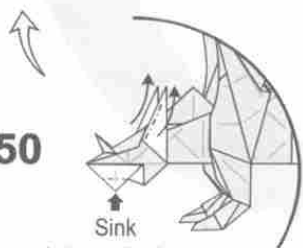

Sink and shape the horns.

49

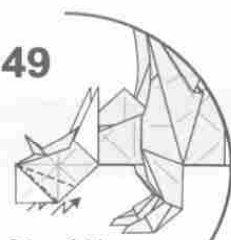

Crimp fold.

48



Valley fold. Repeat on the other side.

44

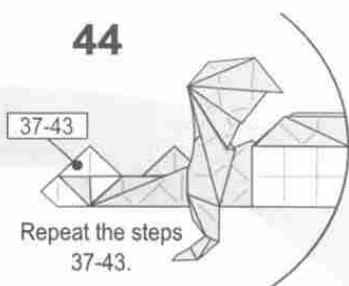

Repeat the steps 37-43.

47

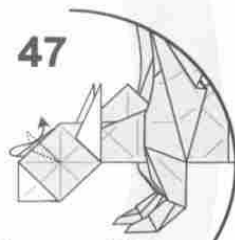

Inside reverse fold.

45

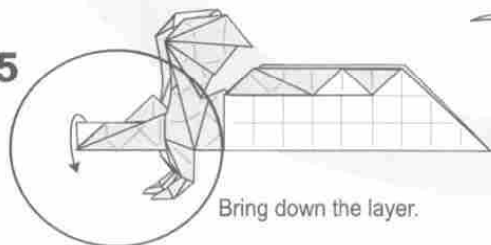

Bring down the layer.

46

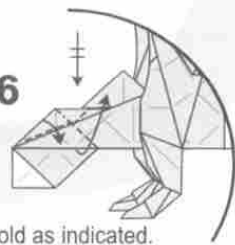

Fold as indicated. Repeat on the other side.

비행하는 용 Flapping Dragon

by Kim DongHyeon : Korea

Diagram by Kim DongHyeon

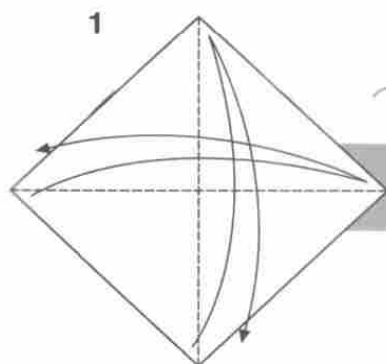
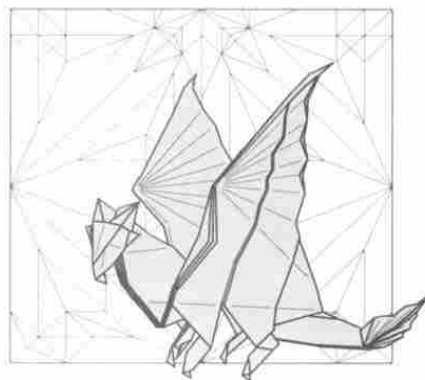

Fold and unfold.

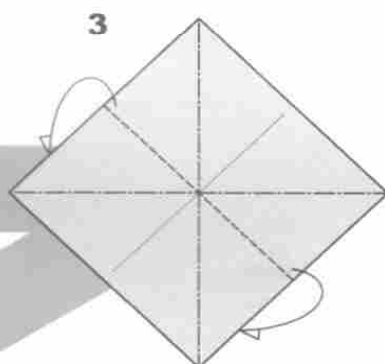
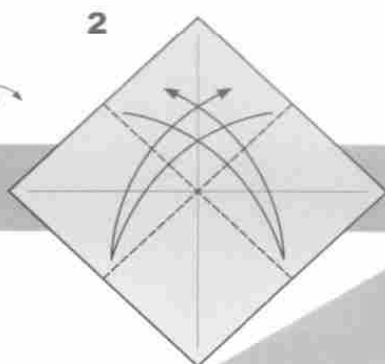

Crease the line.

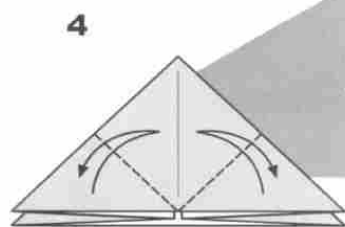

Fold and unfold.

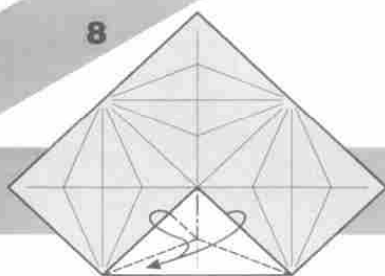
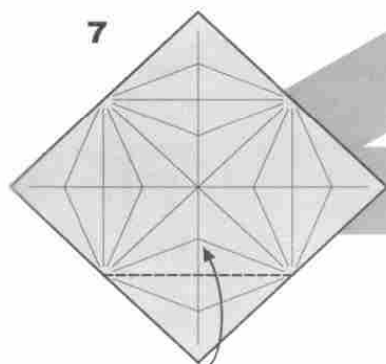
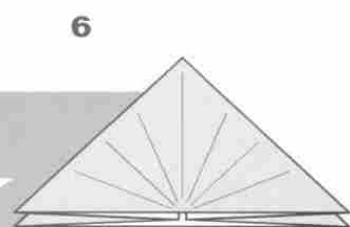
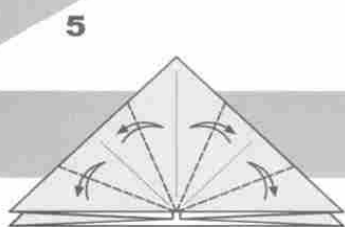

Crease the line.

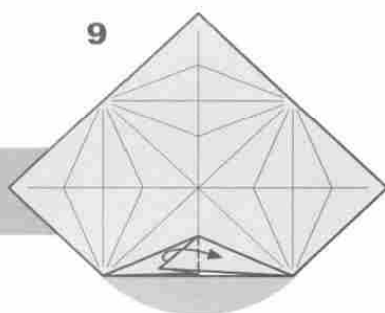

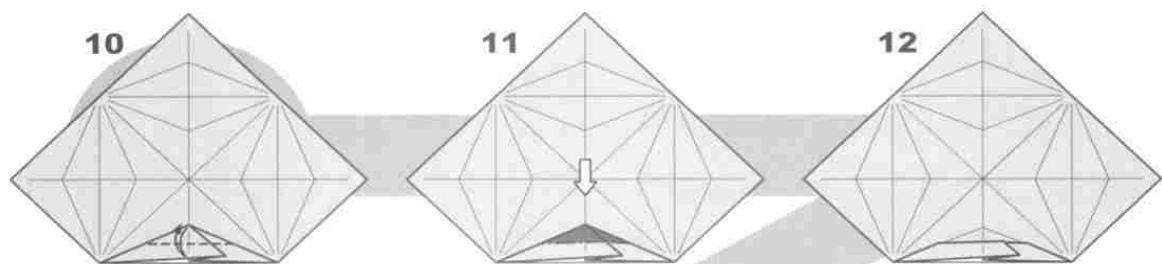

10

Fold and unfold.

11

Open-sink.

12

13

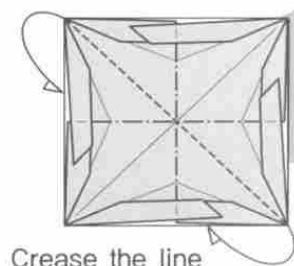

Crease the line.

14

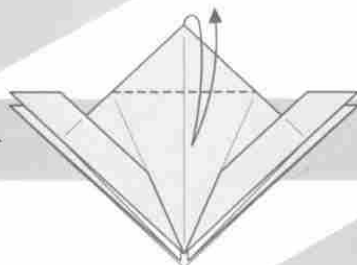

Fold and unfold.

15

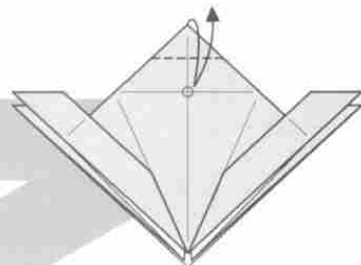

16

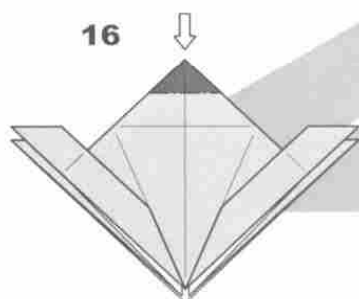

Open-sink.

17

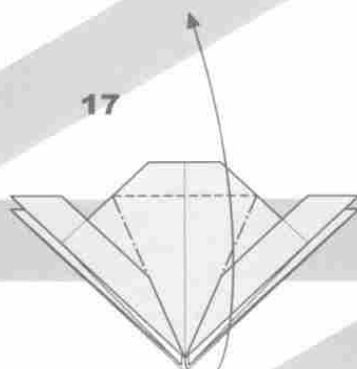

Crease the line.

18

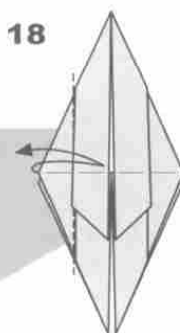

Fold and unfold.

19

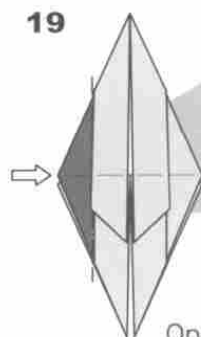

Open-sink.

20

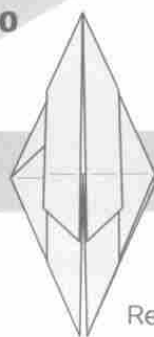

Repeat on the
backside.

21

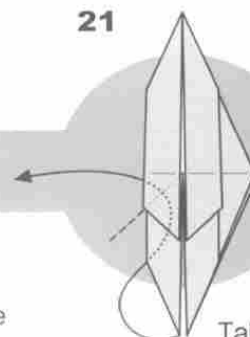

Take out.

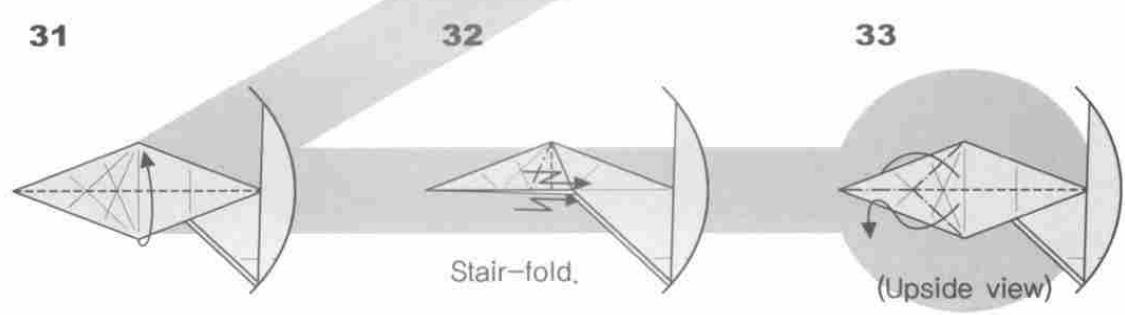
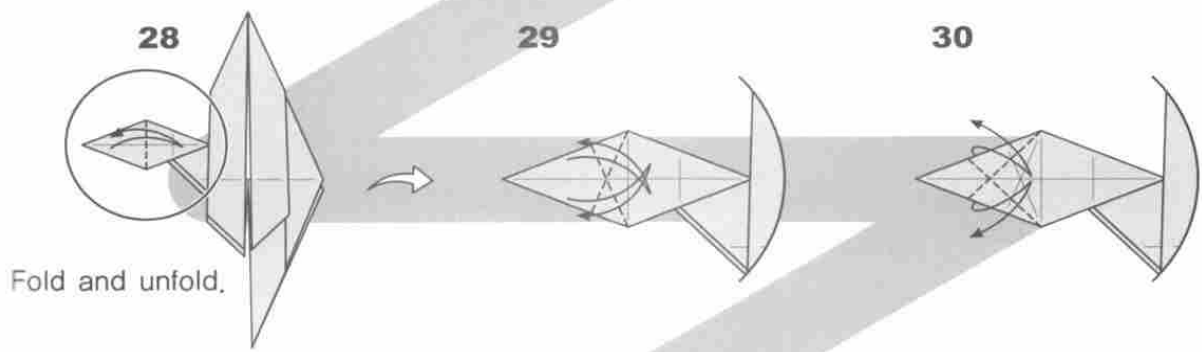
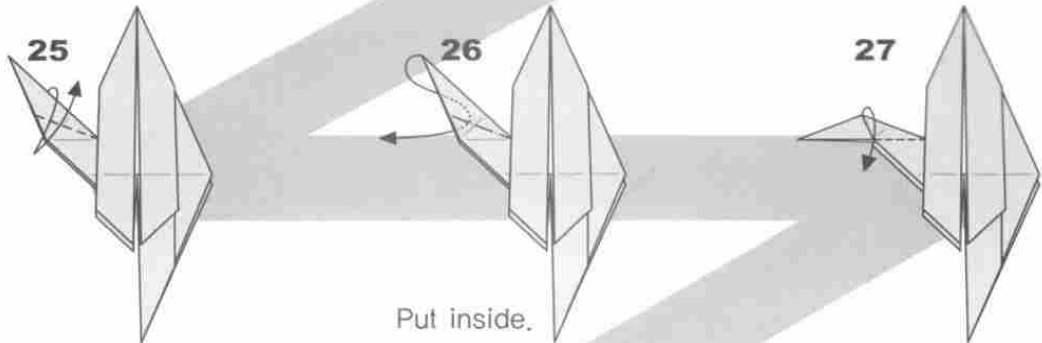
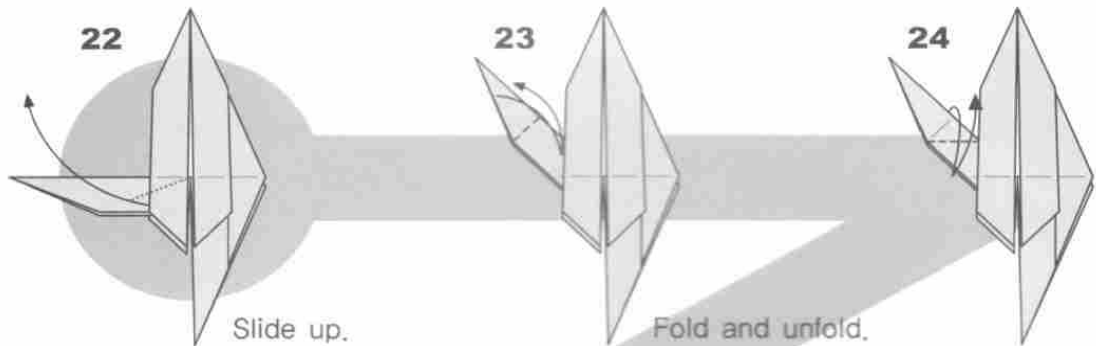

34

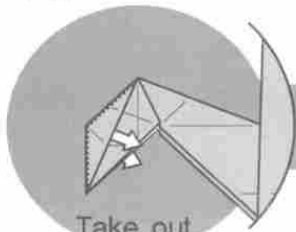

Take out
the inner layer.

35

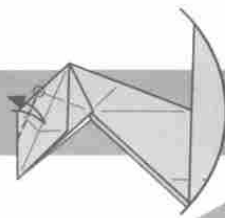

Fold and unfold.

36

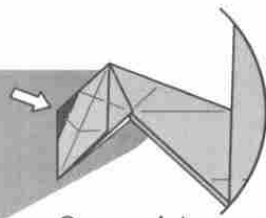

Open-sink.

37

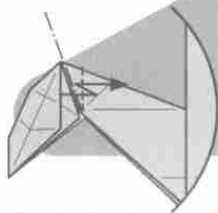

Stair-fold.

38

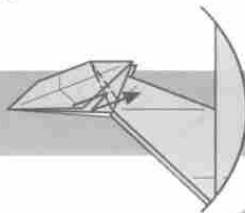

39

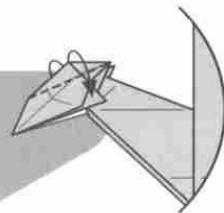

40

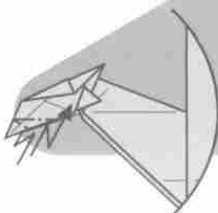

41

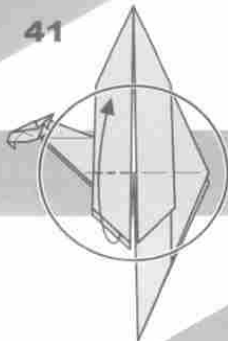

42

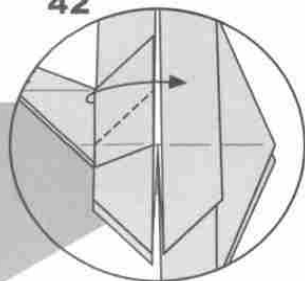

43

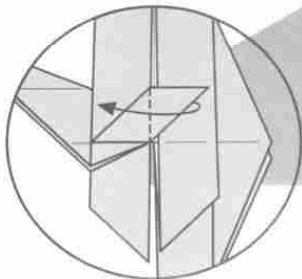

44

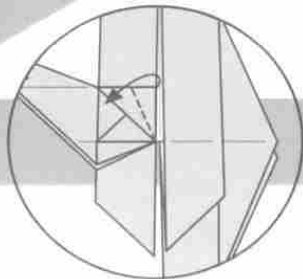

45

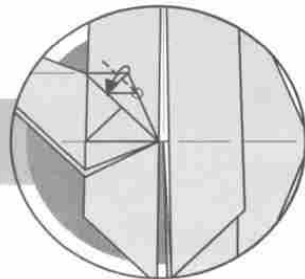

46

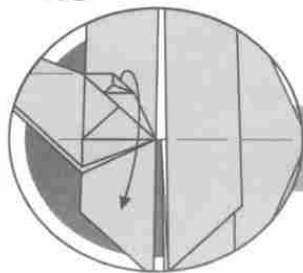

47

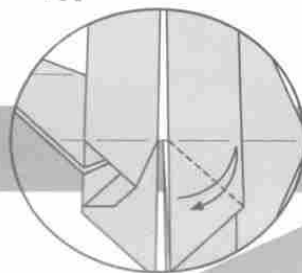

48

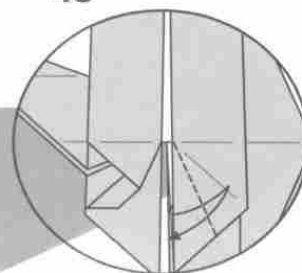

Fold and unfold.

49

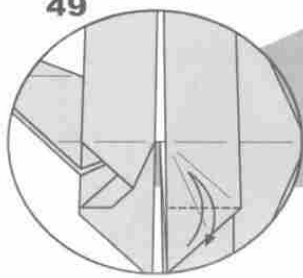

50

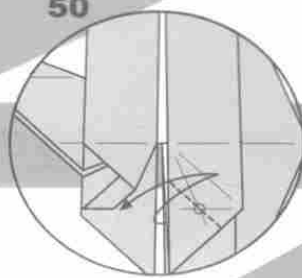

51

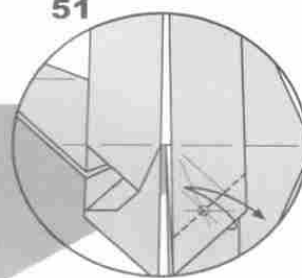

52

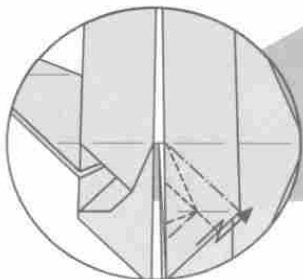

53

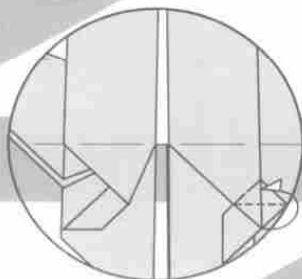

54

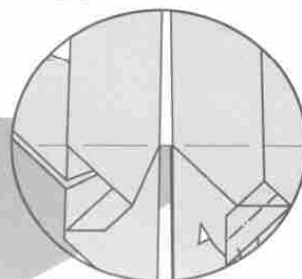

Crease the line.

Put inside.

55

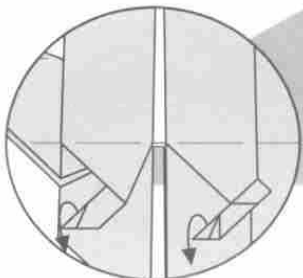

56

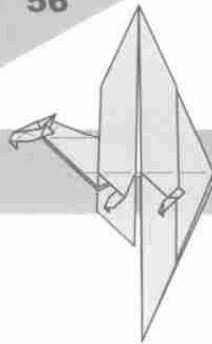

57

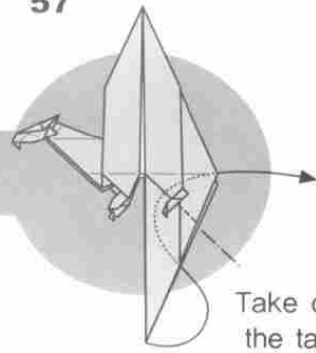

Take out the tail.

58

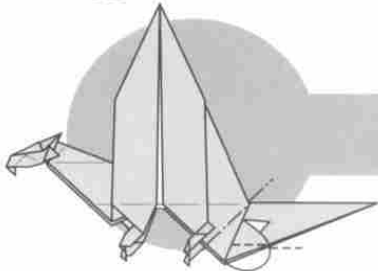

Put inside.

59

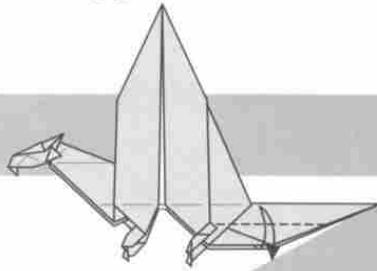

Fold and unfold.

60

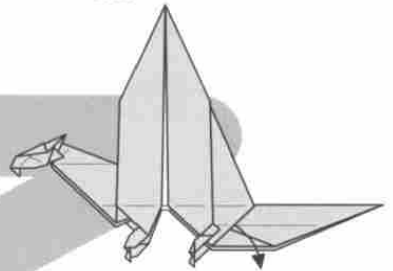

Unfold.

61

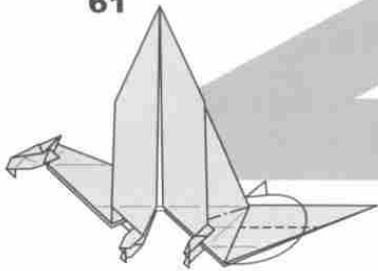

Put inside.

62

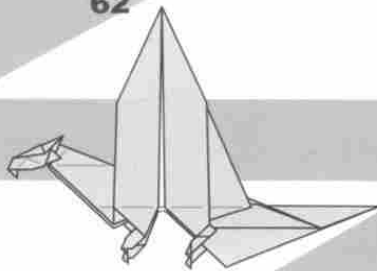

63

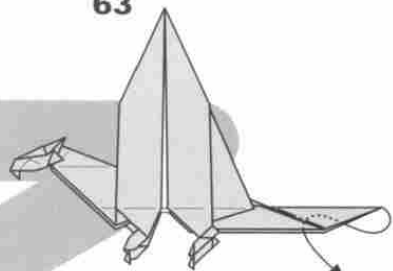

64

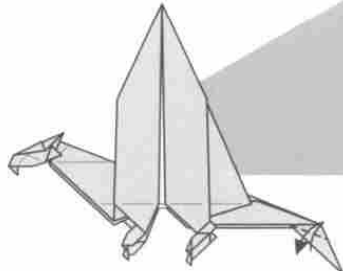

Fold and unfold.

65

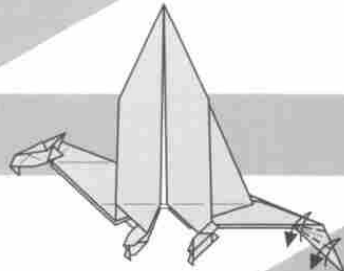

66

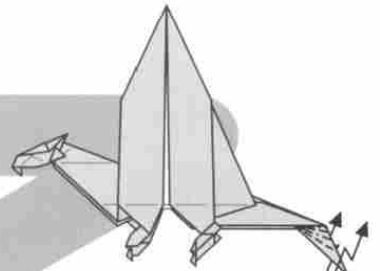

Stair-fold.

67

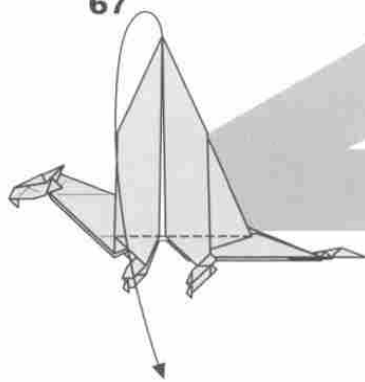

68

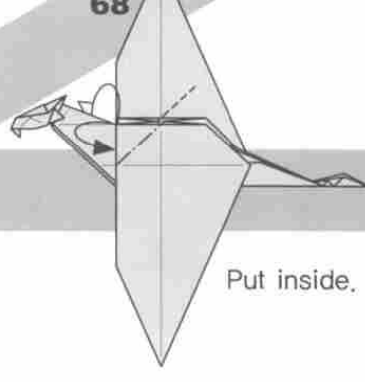

Put inside.

69

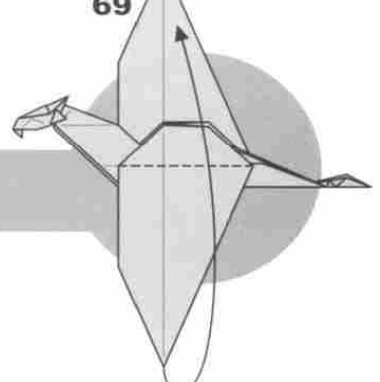

70

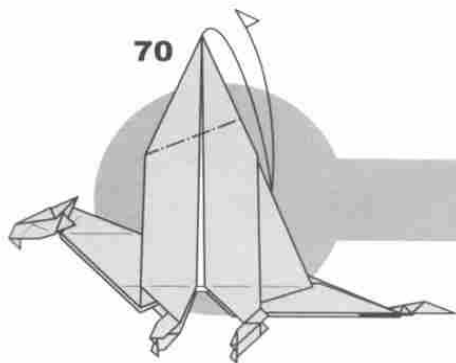

Fold and unfold.

71

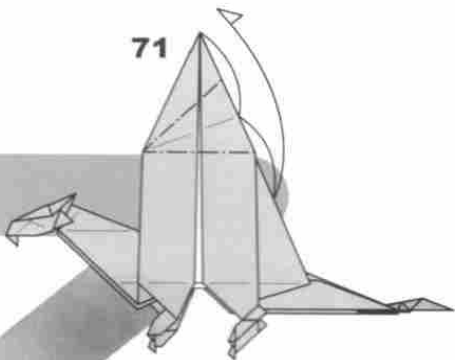

72

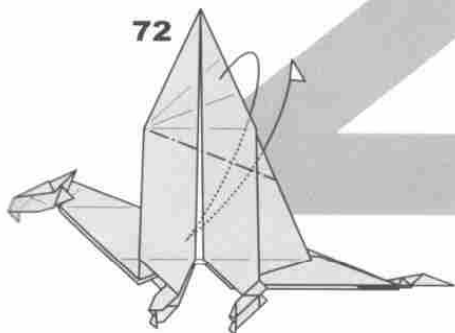

73

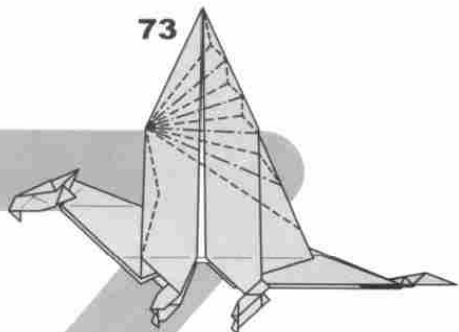

74

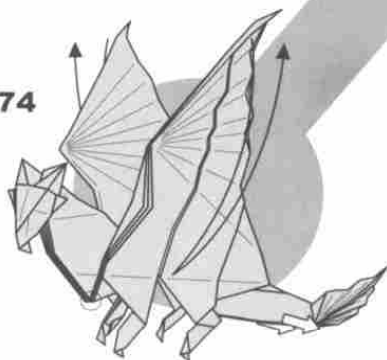

Complete.

The wings are flapping
when grab the body and pull the tail

Little Dragon

by Hiroaki Kobayashi : Japan

Diagram by Hiroaki Kobayashi

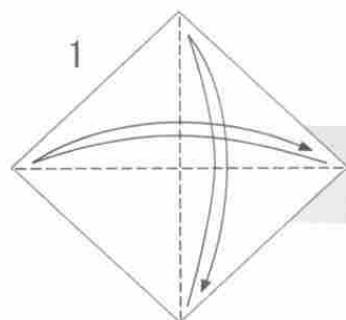
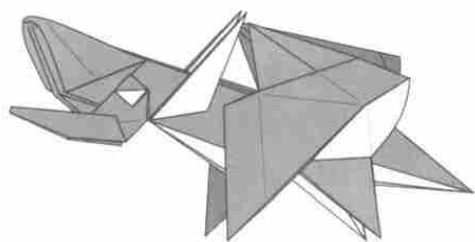

1

カドとカドを合わせて
折り筋をつける

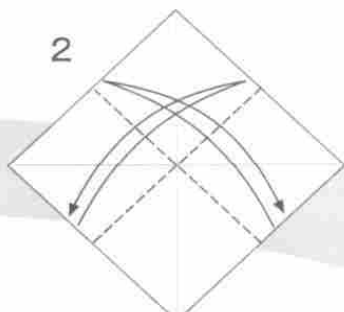

2

フチとフチを合わせて
折り筋をつける

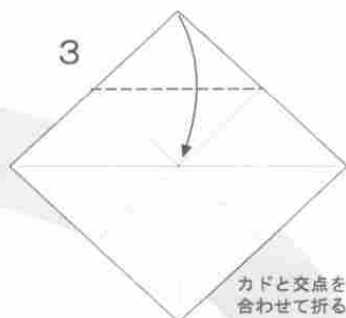

3

カドと交点を
合わせて折る

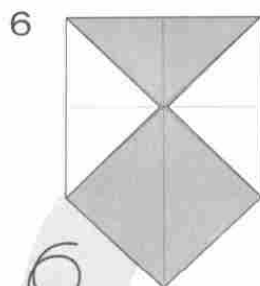

6

裏返す

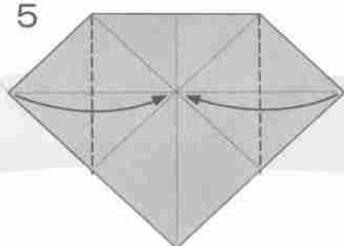

5

カドと交点を合わせて折る

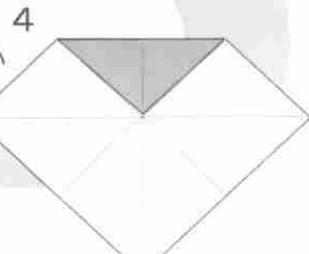

4

裏返す

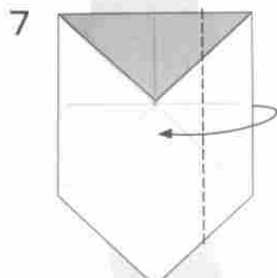

7

フチを折り筋に合わせて折る
裏の紙は折らずに手前に出す



10

フチとフチを合わせて
折り筋をつける

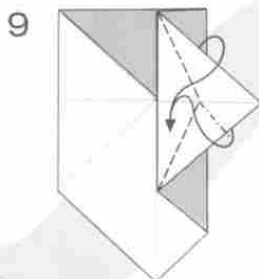

9

つまみ折り

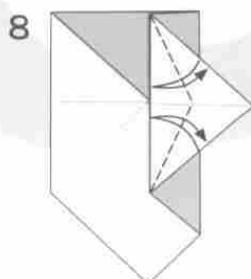

8

フチとフチを合わせて折り筋をつける

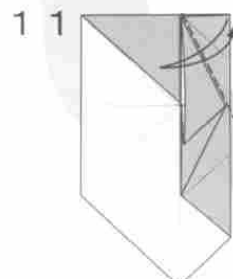

11

フチに沿って折り筋をつける

20

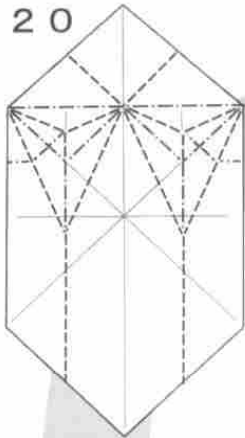

ついている折り筋を使って畳む

21

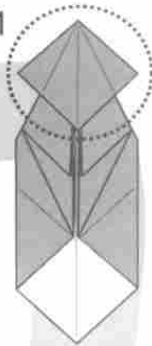

26

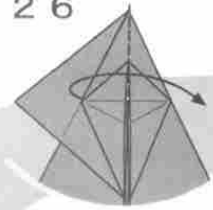

フチを倒す

25

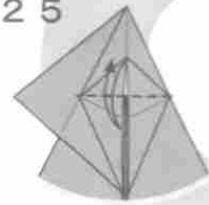

折り筋をつける

22

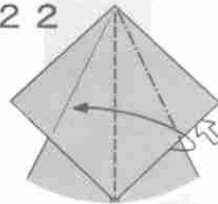

内側を開いてつぶす

24

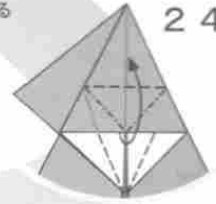

花卉折り

23

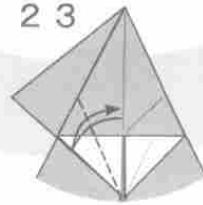

フチとフチを合わせて折り筋をつける

19

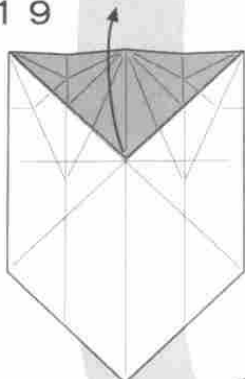

紙を折り上げる

18



広げる

17



カドを折り下げる

16



反対側も7~15と同様に折る

15

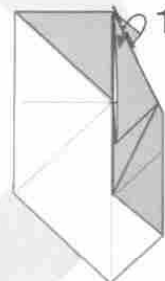

ついている折り筋で中割り折り

12

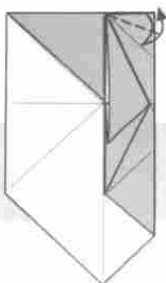

フチと折り筋を合わせて折り筋をつける

13



ついている折り筋で中割り折り

14



ついている折り筋で中割り折り

27 22~26

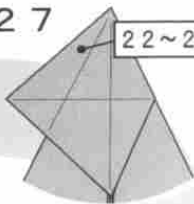

反対側も22~26と同様に折る

28

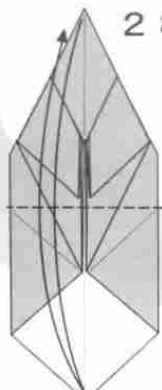

カドとカドを合わせて折り筋をつける

29

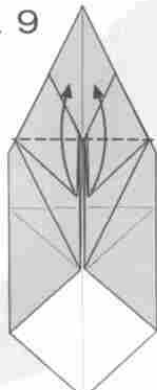

カドを上折る

30

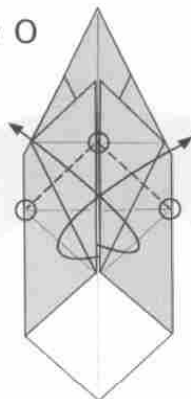

○同士をつなぐ線で折る

31

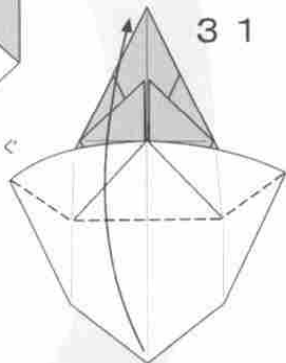

平らにたたむ

33

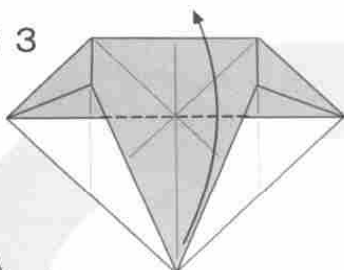

カドを折り上げる

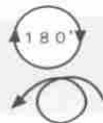

32

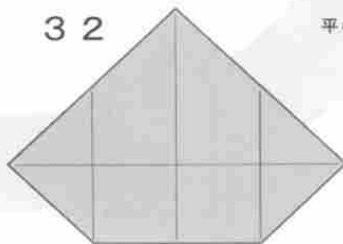

34

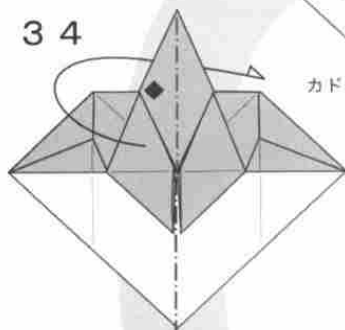

◆の1枚を残し、山折り

37

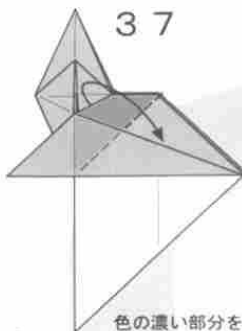

色の濃い部分を谷折り

38

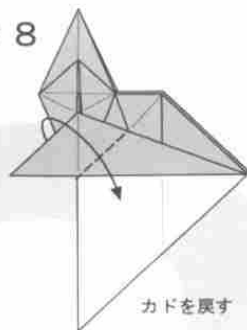

カドを戻す

35

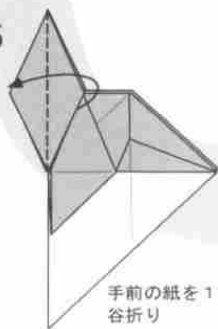

手前の紙を1枚谷折り

36

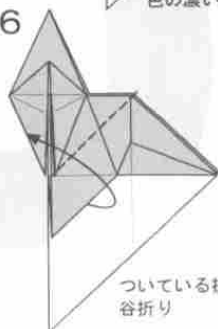

ついている折り筋で谷折り

39

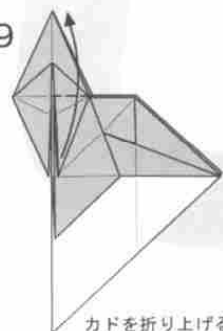

カドを折り上げる

48

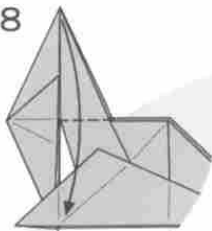

カドを折り下げる

49

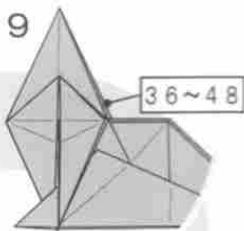

反対側も36~48と同様に折る

53

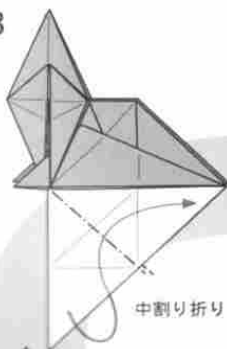

中割り折り

47

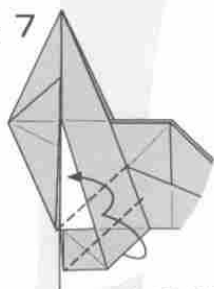

ついている折り筋で巻くように折る

50

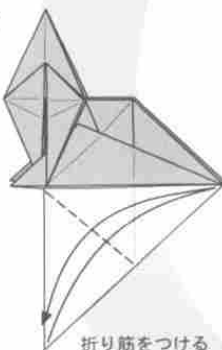

折り筋をつける

52

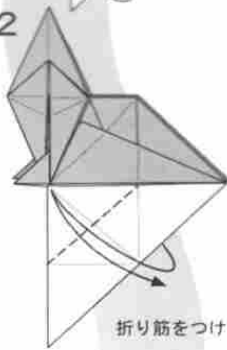

折り筋をつける

51

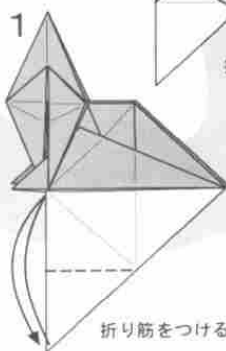

折り筋をつける

46

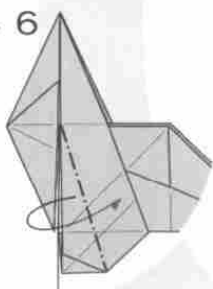

内側に折り込む

45

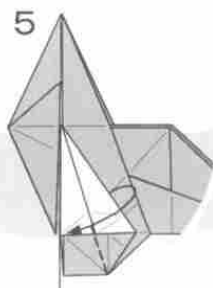

フチを谷折り

44

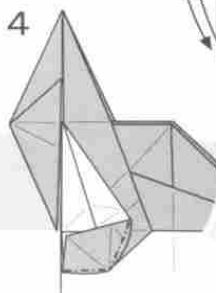

平らにたたむ

43

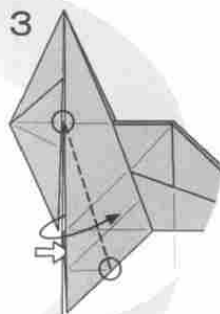

○同士をつなぐ線で折る

40

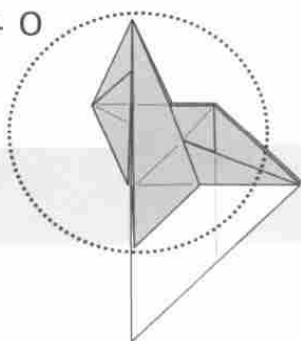

41

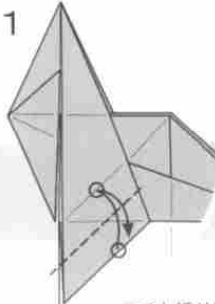

フチと折り筋を合わせて折り筋をつける

42

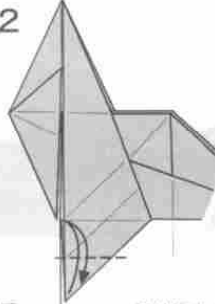

折り筋をつける

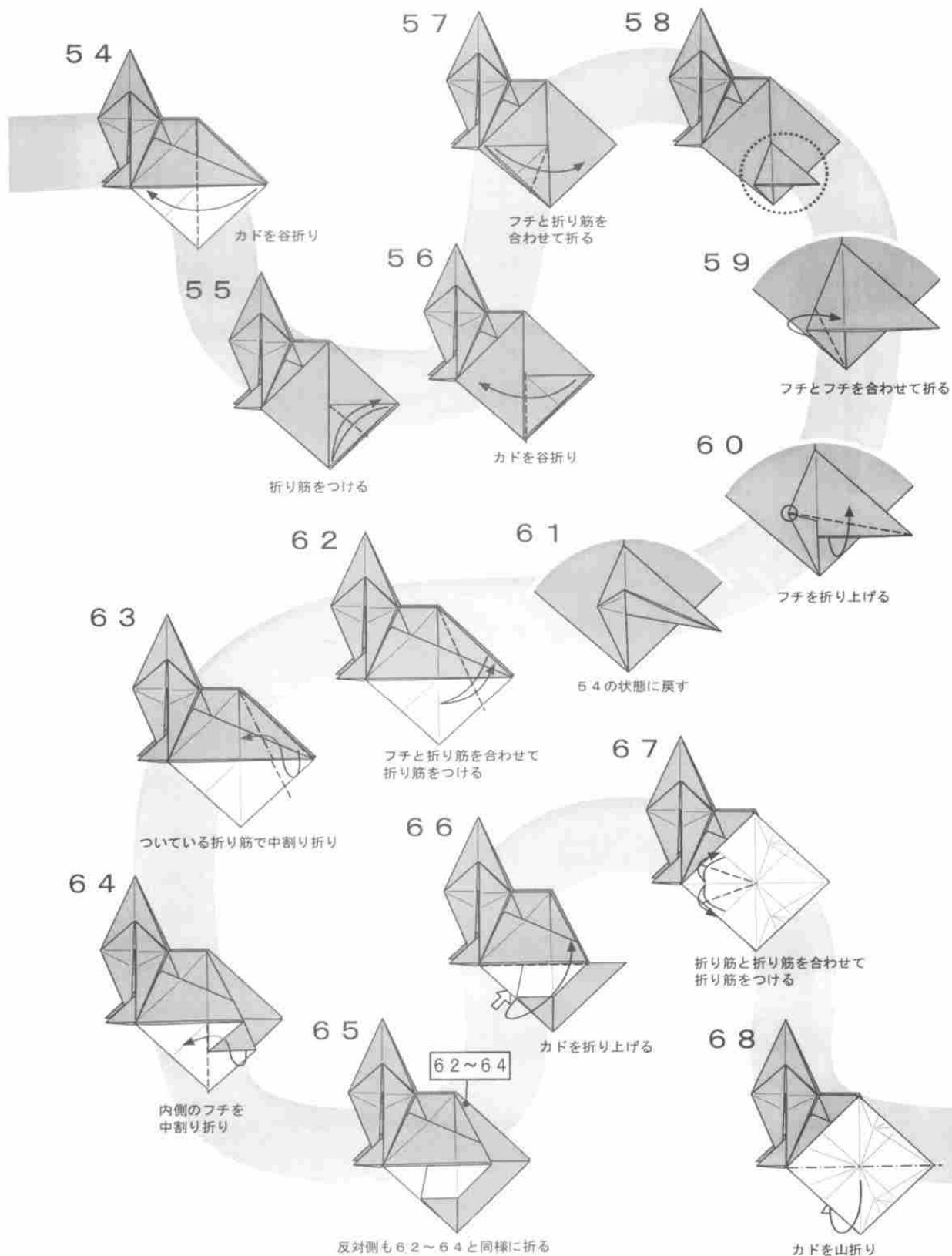

77

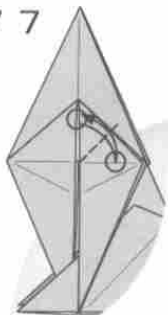

78

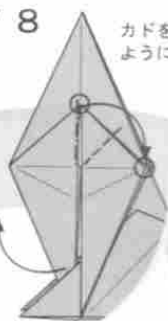

カドを合わせる
ように折る

82

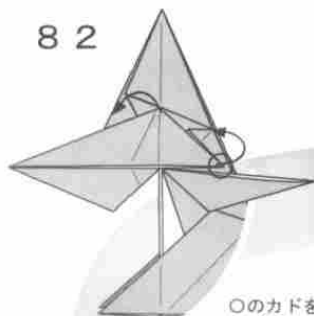

○のカドを
ずらすように折る

○同士を合わせて
折り筋をつける

76

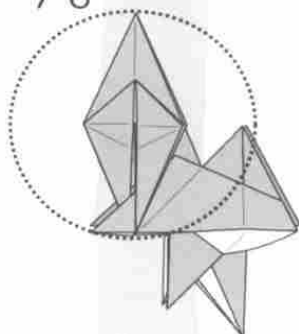

79

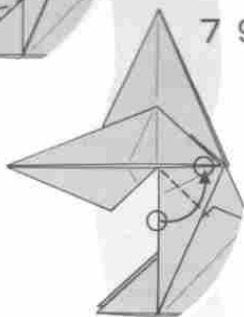

フチとフチを合わせて折る

81

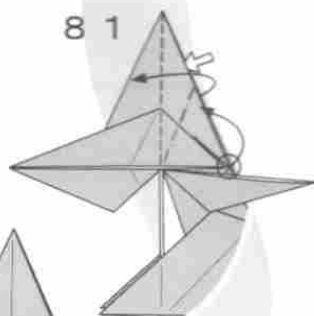

手前のフチを段折りして
○のカドをずらすように折

75

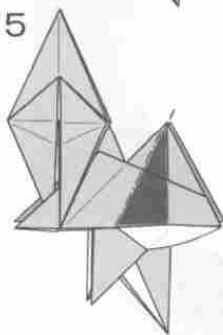

内側のカドを中割り折り

74

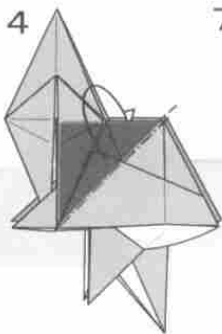

内側のカドを中割り折り

73

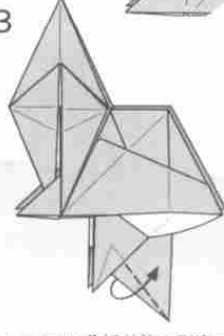

ついている折り筋で引寄せ折り
反対側も同様

カドをかるく開く

72

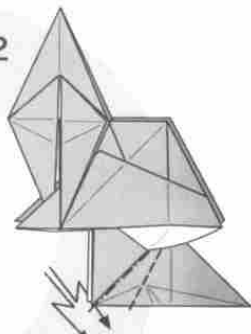

ついている折り筋で
両側同時に段折り

69

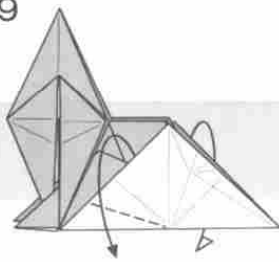

ついている折り筋で
両側同時にかぶせ折り

70

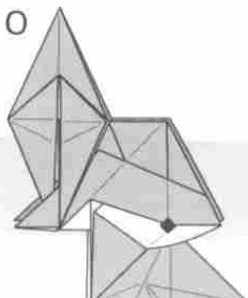

◆部分は立体的になる

71

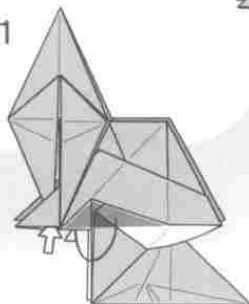

色の濃い部分を内側の層に入れる
反対側も同様

83

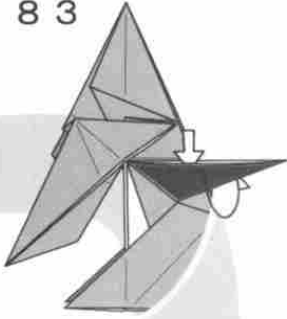

手前から2番目の層を開いて色の濃い部分をかぶせ折り

85

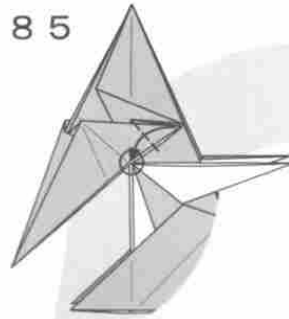

カドを谷折り

86

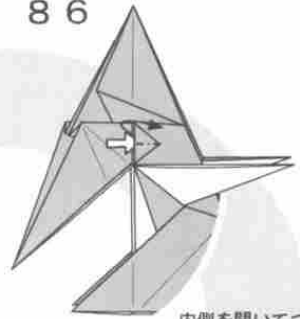

内側を開いてつぶす

84

77~83

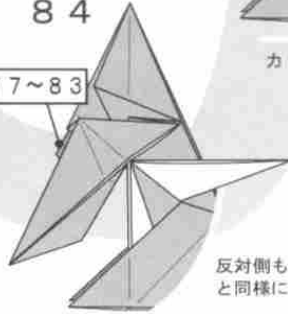

反対側も77~83と同様に折る

87

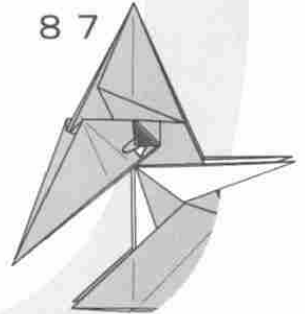

色の濃い部分をかぶせ折り85の状態まで戻してから折ると折りやすい

89

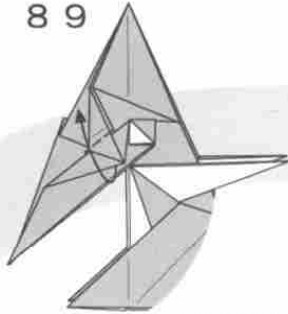

カドを谷折り

88

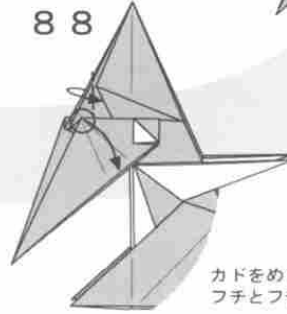

カドをめくりながらフチとフチを合わせて折る

90

85~89

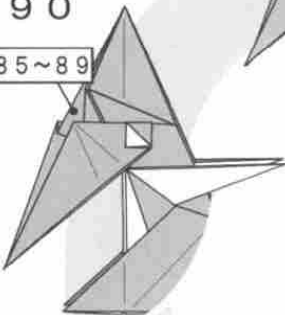

反対側も85~89と同様に折る

93

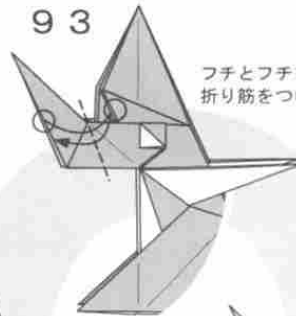

フチとフチを合わせて折り筋をつける

91

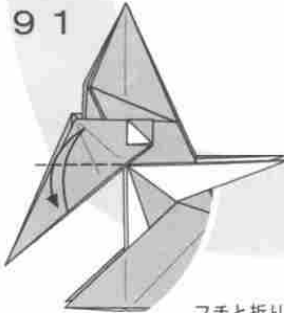

フチと折り筋を合わせて折り筋をつける

92

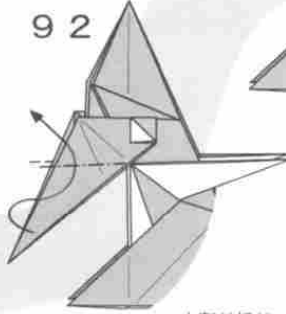

中割り折り

94

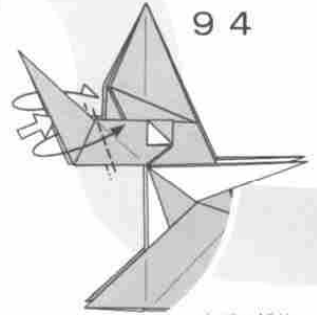

かぶせ折り

101

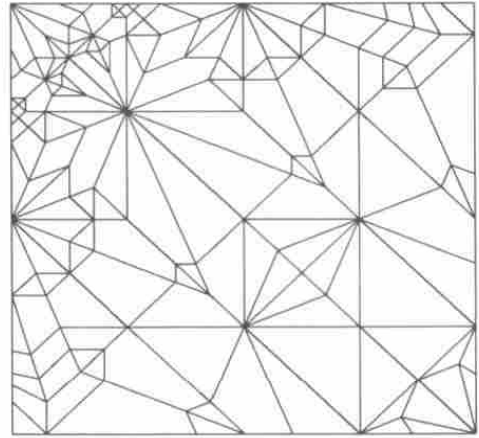
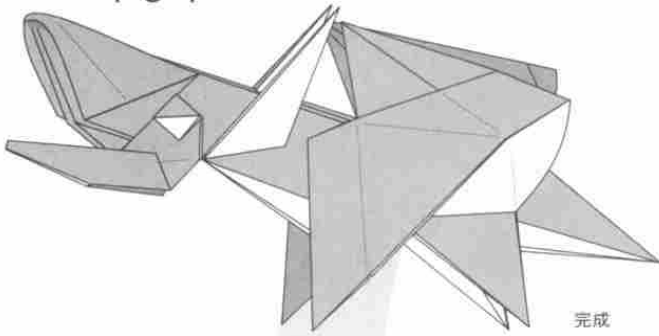

100

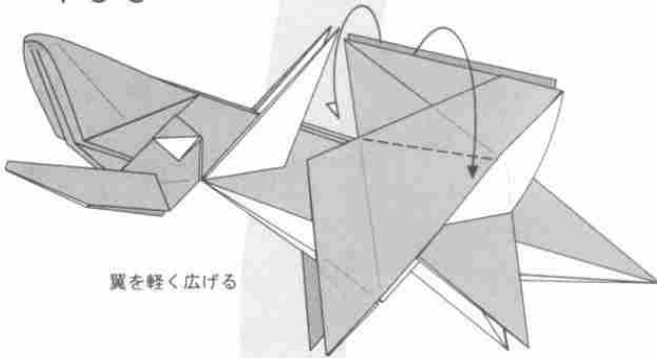

翼を軽く広げる

99

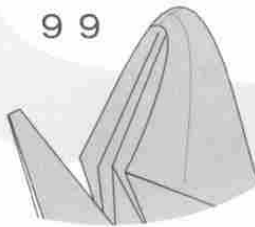

口先に丸みをつける

98

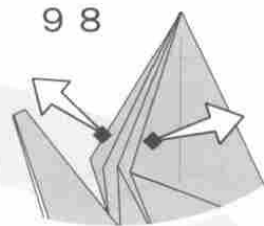

両側のフチをつまんで引っ張る

95

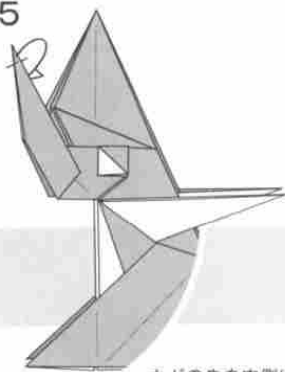

カドの先を内側に
折り込む

96

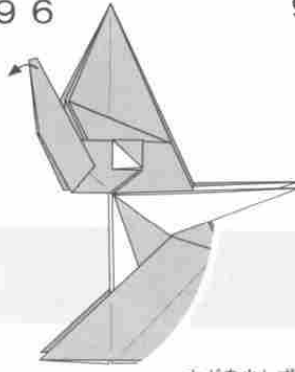

カドを少しずらす

97

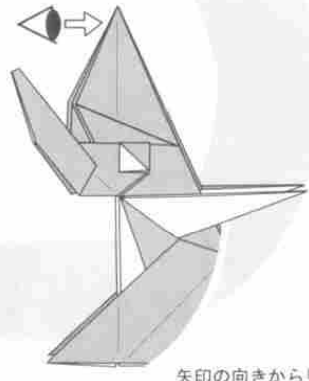

矢印の向きから見る

The west Dragon

Designer by Wang Hongfeng : China

Painter by Yu Gong

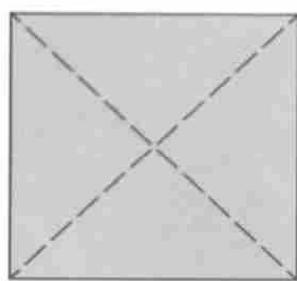
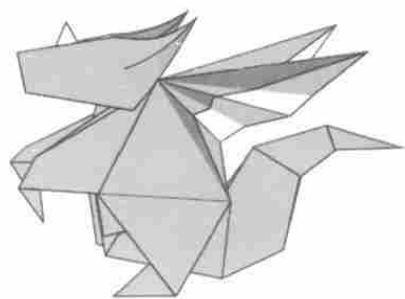

1. 留下折痕

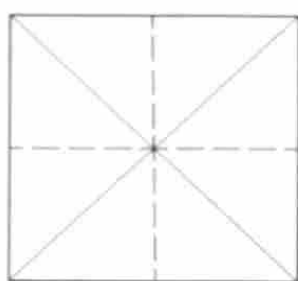

2. 留下折痕

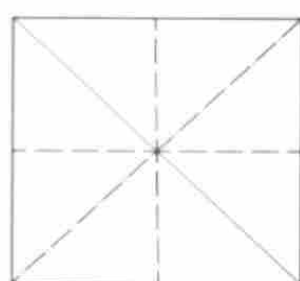

3. 沿折痕聚拢

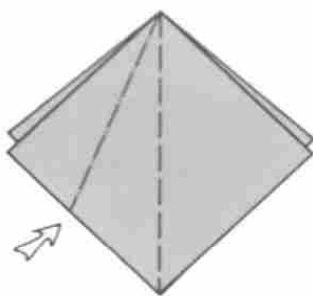

4. 左侧撑开，压平

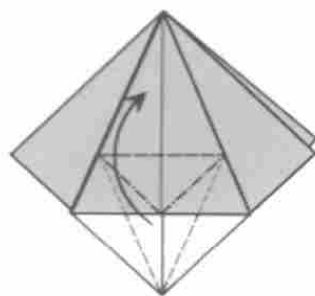

5. 如图花瓣折

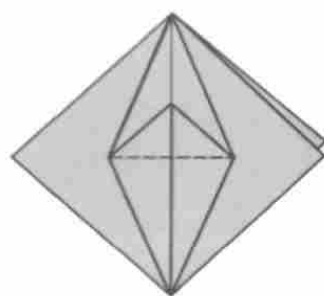

6. 将三角折下

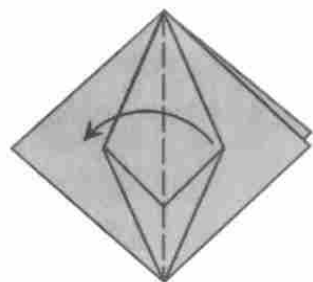

7.向左翻折

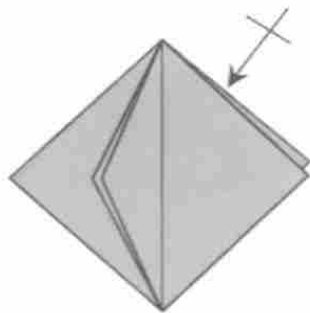

8.另一側重复4~7

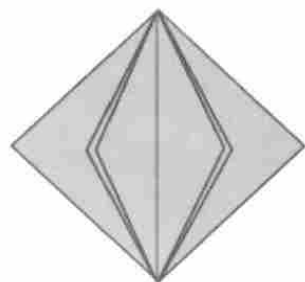

9.翻到背面

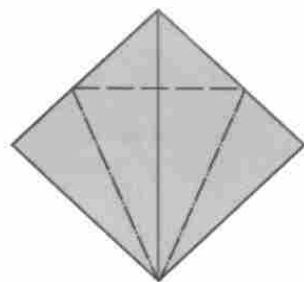

10.花瓣折

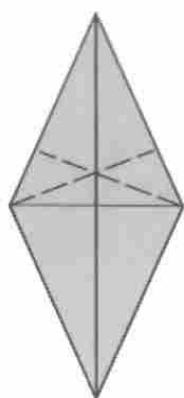

11.留下折痕

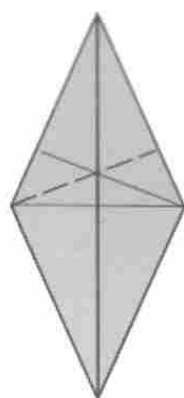

12.沿折痕对折

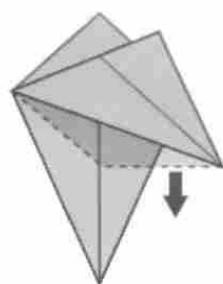

13.抽出里面的纸层

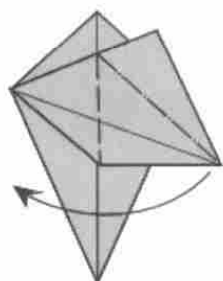

14.

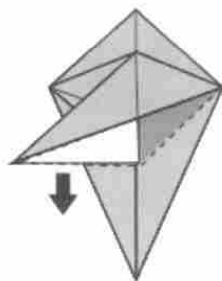

15.同第13步

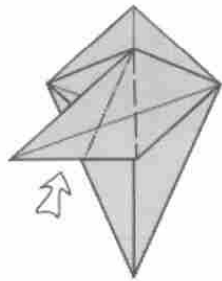

16.撑开压平

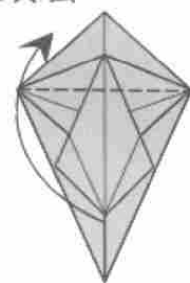

17.向上翻折

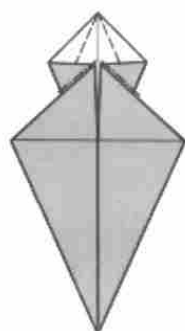

18.花瓣折

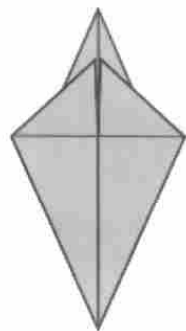

19.翻面

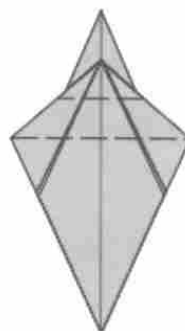

20.对折留下折痕

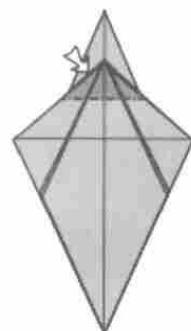

21.阴影部分分开沉

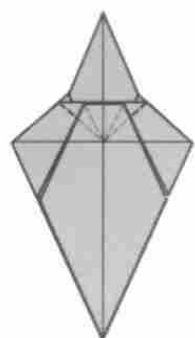

22.打开

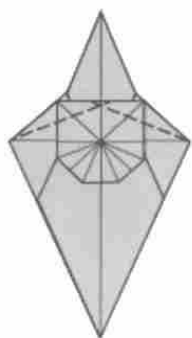

23.对折

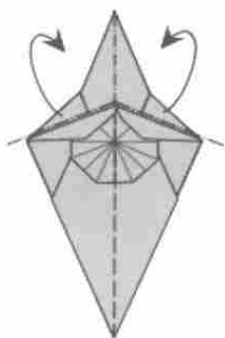

24.如图

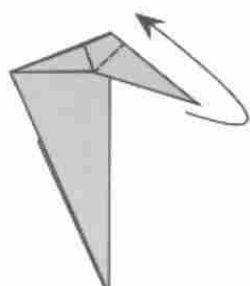

25.翻折

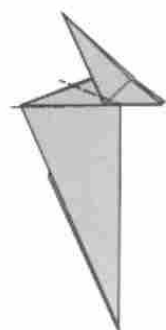

26.段折

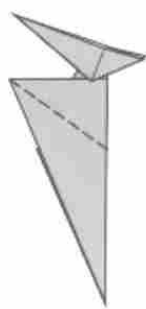

27.

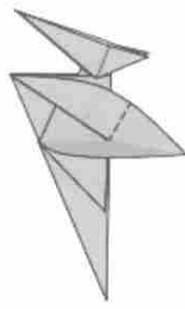

28.压平

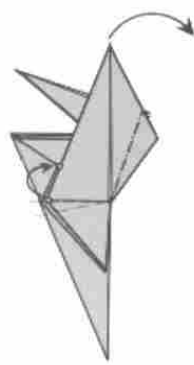

29.如图“旋转”
最上方纸层

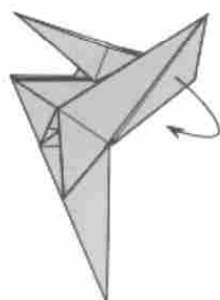

30.翅膀部分翻色

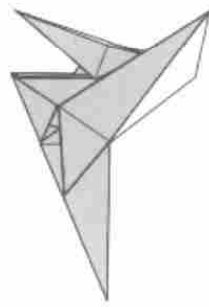

31.背面重复
27~30

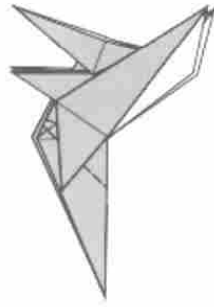

32.尾部向外翻折

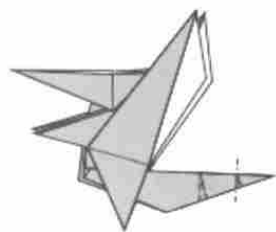

33.

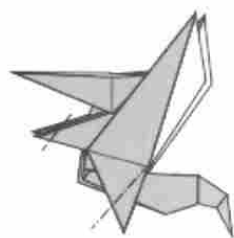

34.手与脚
向内翻折

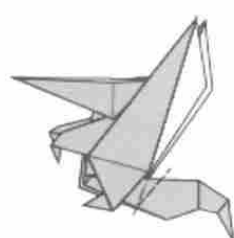

35.尾部段折

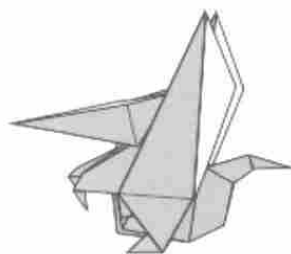

36.向外翻折
(二等分)



37. 抽出被压住的纸层



38. 内部的三角向外翻折



39. 抽出里面的纸层

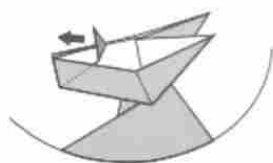

40. 沿着背部对折

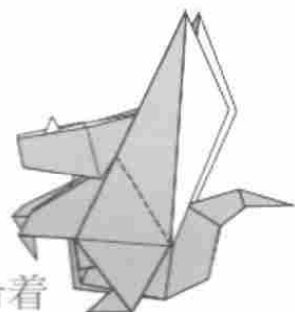

42. 再次沿着背部对折



43. 先后进行两次对折

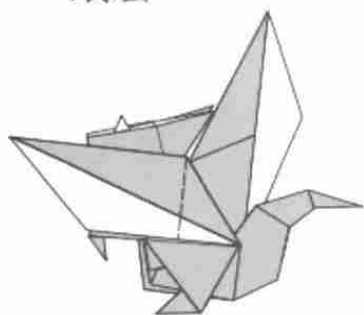

41. 对折

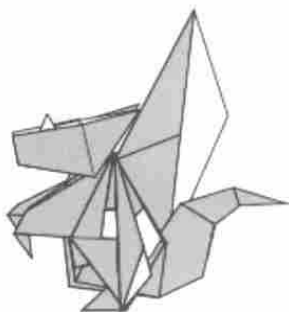

44. 背面相同

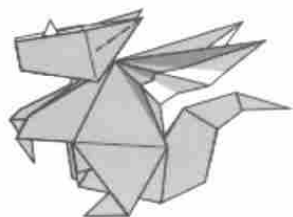

45. 捏一下角

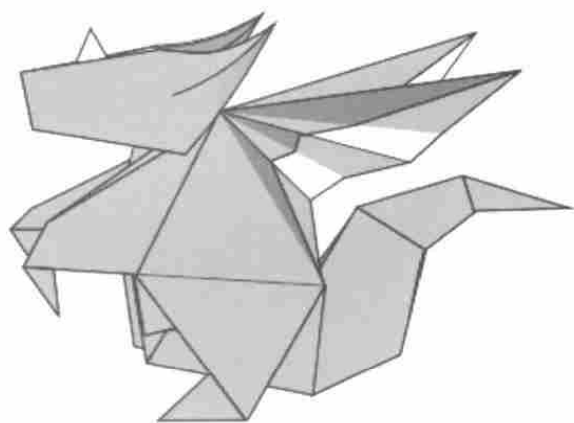

完成!!!

용2021 Dragon2021

by Lee JaeYoung : Korea

Diagram by Lee JaeYoung

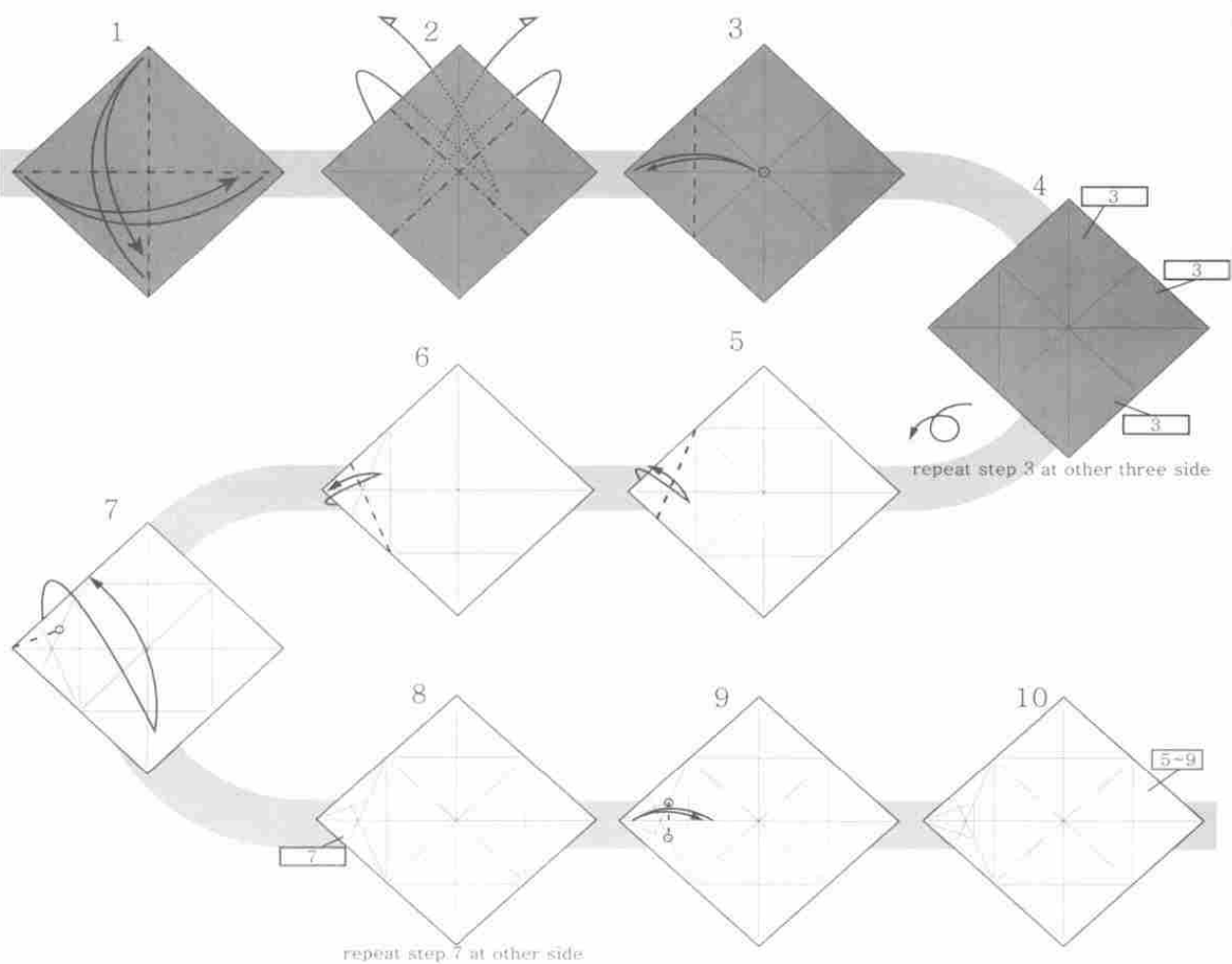
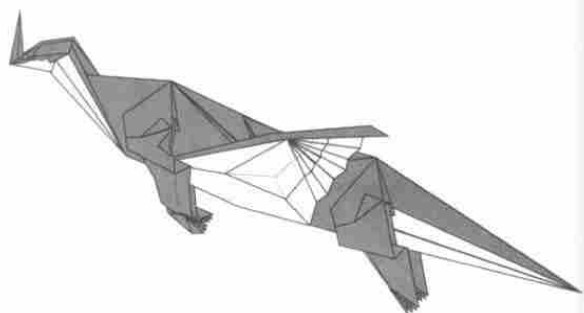

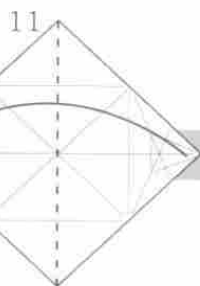

12

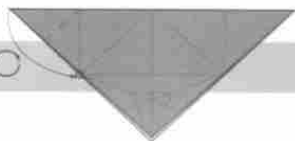

13

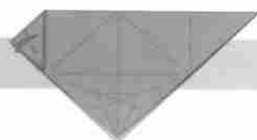

14

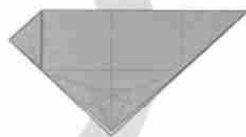

unfold step 12

16

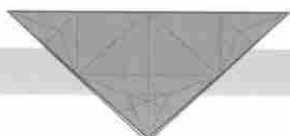

unfold step 11

15

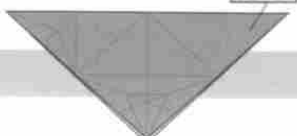

repeat step 13-14 at other side

17

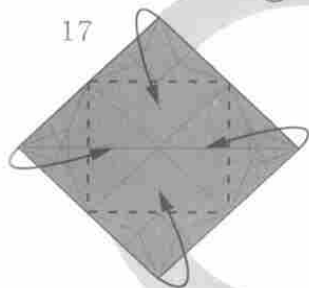

18

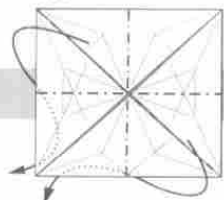

fold preliminary base

19

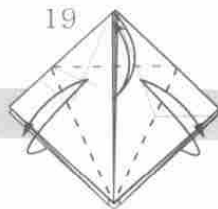

20

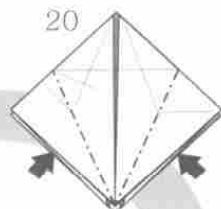

23

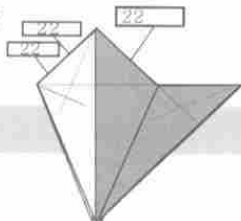

repeat step 22 at other three side

22

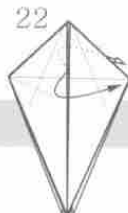

Do out-side reverse fold at the top layer

21

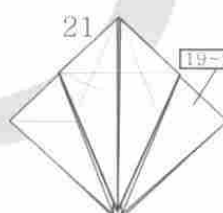

repeat step 19-20 at other side

24

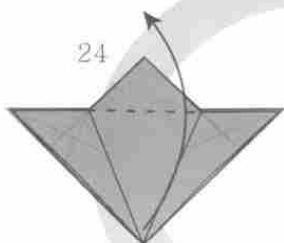

25

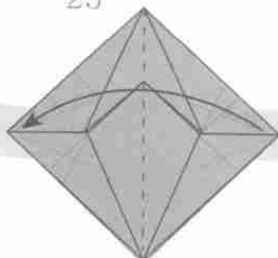

26

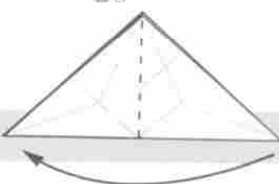

27

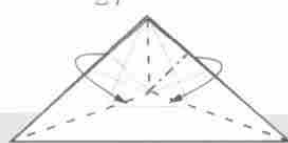

Do rabbit ear fold

28



open sink

29

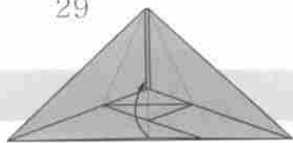

raise top layer

30

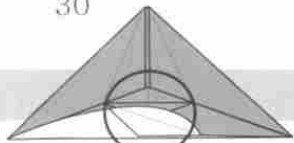

31



33



zoom out

32



open sink

34

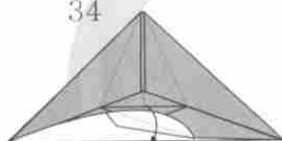

35

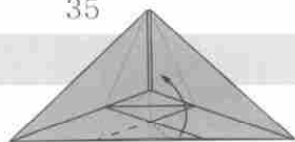

36



37

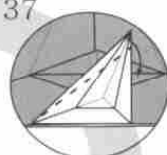

40

36-39



repeat 36-39 at the back side

39

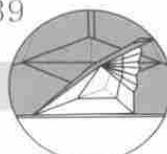

zoom out

38



41



42



43



44



45

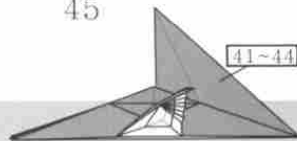

41-44

46

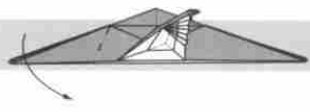

47



48



unfold step47

49



52

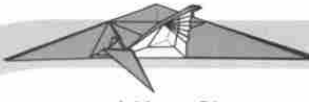

51

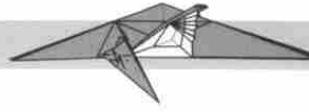

50



53



unfold step51

54

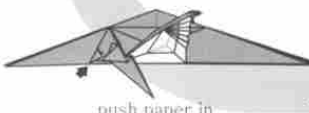

push paper in

55

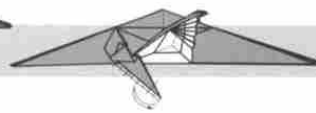

56

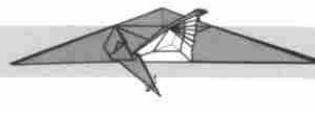

57



60



Fold inward along the dotted line

59

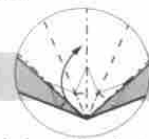

Fold along the dotted line

58

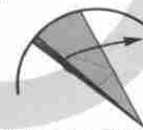

Unfold it according to the arrow.

61



Fold inward along the dotted line

62



Repeat - at the other two layers

63



zoom out

64



65

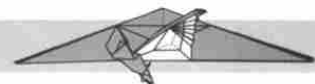

66



fold and repeat three other layers

67



68



69



70

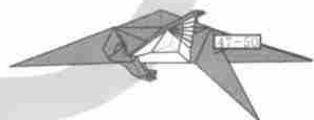

repeat 47-50 at the back side

72

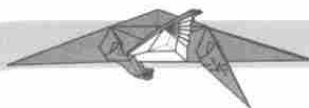

71



push paper in

73



unfold step 47

74

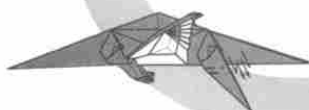

75

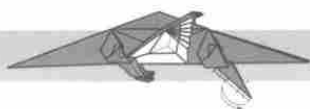

76



repeat 55-60

77



repeat 66-73 at the back side

80



fold up all the layers

79

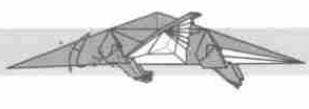

78

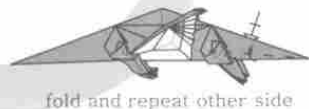

fold and repeat other side

81



82



fold down all the layers

83

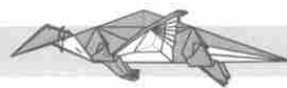

84



85



do rabbit ear fold

86



repeat 66-73 at the back side

87

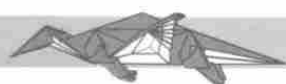

88



closed sink

92



unfold step 91

91



90



fold and repeat other side

89



zoom in

93



93



94



95



98



97



96-1



more enlarged version

96



99



repeat 66-73 at the back side

100



zoom out

101



102



103



104



push paper in and repeat other side

105



Finish

산타 클로스 Santa claus

by Gen Hagiwara : Japan

Diagram by Gen Hagiwara

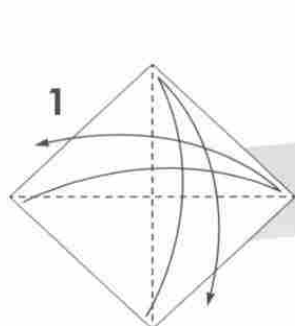
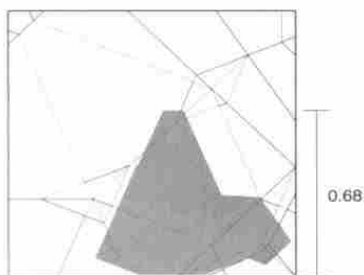
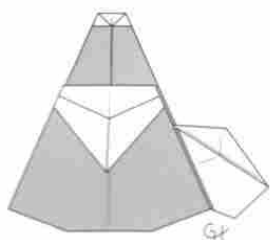

1
対角線に折り筋をつける
Fold diagonals and unfold.

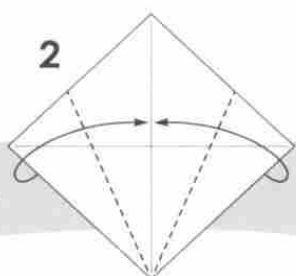

2
フチを折り筋にあわせて折る
Fold the edges to the crease line.

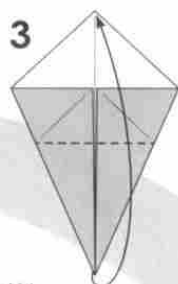

3
カドとカドをあわせて折る
Fold the corner to the corner.



体、帽子
Body, Hat
顔、帽子の先、サンタ袋
Face, Hat tip,
Santa's sack

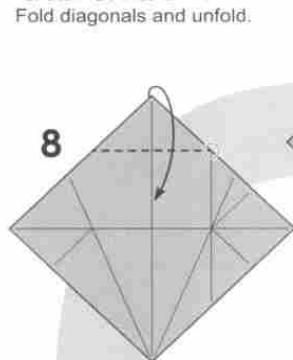

4
カドを○のところで折る
Fold the corner at the circled point.

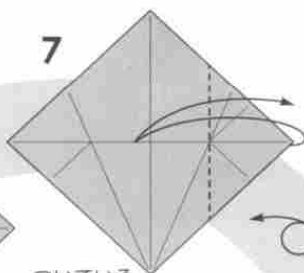

5
ついている折り筋のところで折って折り筋をつける
Fold at the existing crease line and extend the crease.

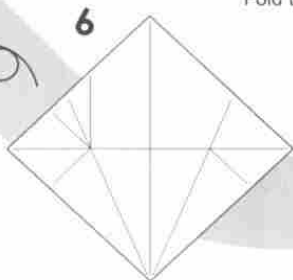

6
フチとフチをあわせて折る
Fold the edge to the edge.

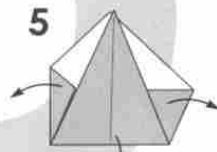

7
全部戻す
Unfold all.

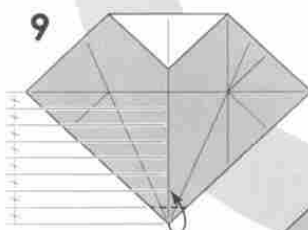

8
大体 1/8 のところでカドを折る
Fold the corner at about 1/8.

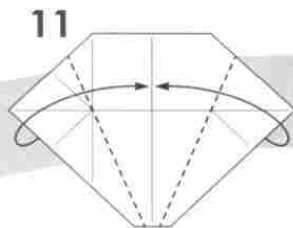
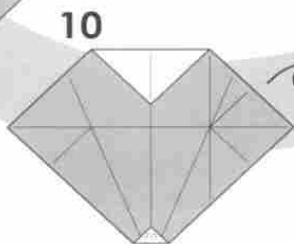

9
ついている折り筋で折る
Fold at the existing crease lines.

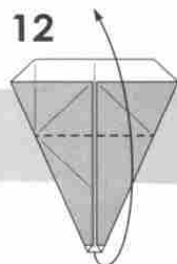

10
ついている折り筋で折る
Fold at the existing crease lines.

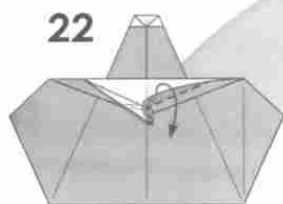

22
 起き上がってきた
 紙を潰して平らに折る
 Squash the elevated
 layer and flatten the model.

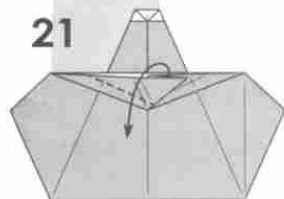

21
 ついている折り筋でカドを折る
 Fold the corner down
 at the existing crease line.

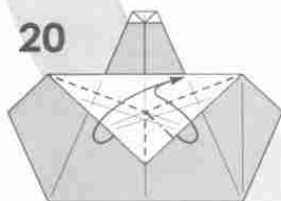

20
 つまみ折り
 Rabbit ear fold.

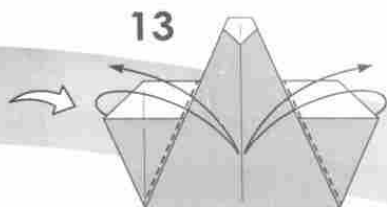

13
 手前のフチの
 ところで折って折り筋をつける
 Fold along the edge and unfold.

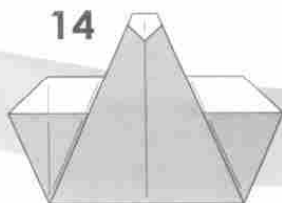

14



15

フチとフチをあわせて折る
 Fold the edge to the edge.

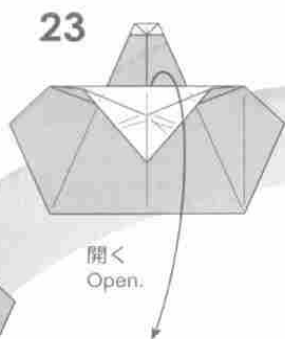

23
 開く
 Open.

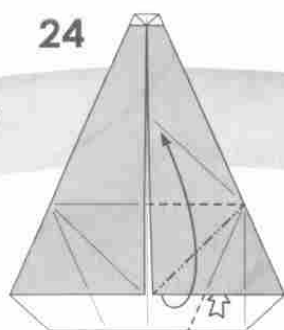

24
 ついている折り筋をつかって
 つまみ折りのように折る
 Fold diagonals and unfold.

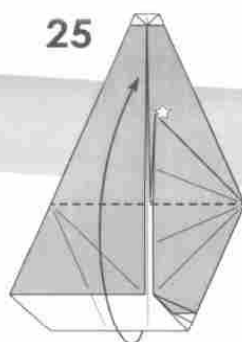

25
 開いていた部分を戻す
 Fold up the layers.

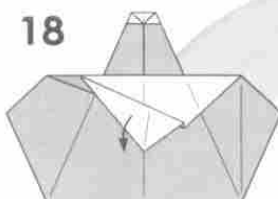

18
 15の状態まで戻す
 Unfold to 15.

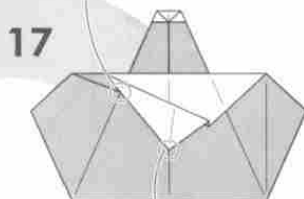

17
 紙のフチが折りフチと折り筋の
 交点に重なるようにする
 Align the edge onto the intersection
 of the folded edge and the crease line.

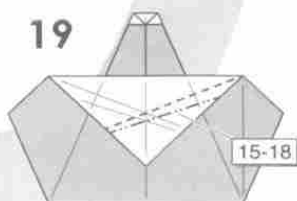

19

反対側も 15-18 と同様に折り筋をつける
 Repeat 15-18 on the other side.

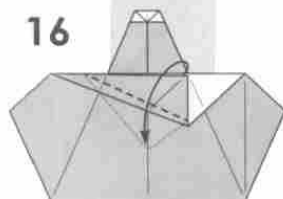

16

カドを下へ折る
 折りの基準は次の図を参照
 Fold the corner down.
 Refer to the next step
 for the folding reference.

26

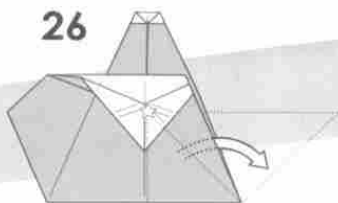

ついている折り筋をつかって
隠れているカドを引き出す
Use the existing crease lines to
pull out the hidden flap.

27

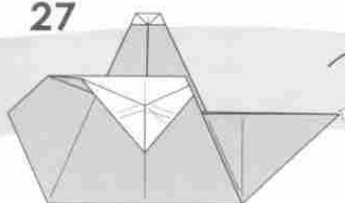

28

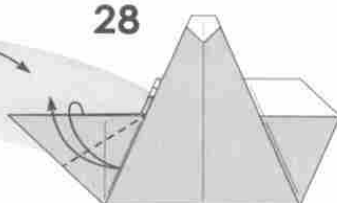

フチとフチを
あわせて折り筋をつける
Fold the edge to the edge
and unfold.

33

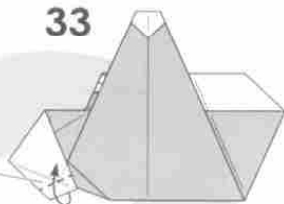

引っ掛かる
ところでフチを折る
Fold the edge.

29

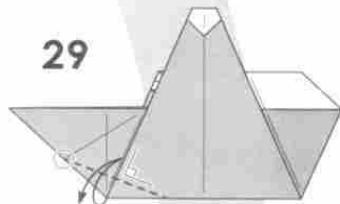

○のところからカドを
折って折り筋をつける
Fold the corner at the
circled point and unfold.

34

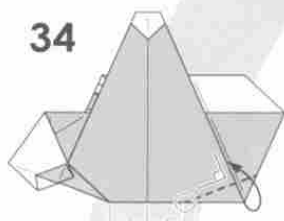

裏側
Back side.

左側と同じところでカドを折る
Fold the corner as the left side.

32

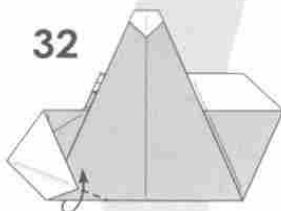

ついている
折り筋でカドを折る
Fold the corner
at the crease line.

31

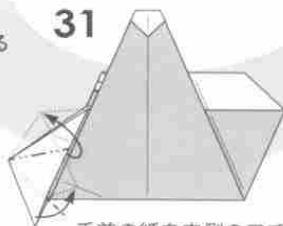

手前の紙を内側のフチに
引っ掛かるまでずらすように折る
Slide the top layer up
until it hits the inner edge.

30

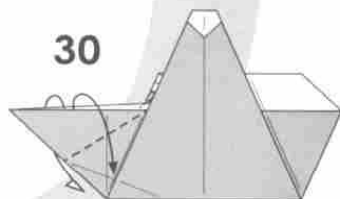

ついている
折り筋でかぶせ折り
Outside reverse fold.

35

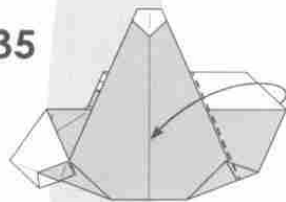

ついている折り筋で折る
Fold at the existing crease line.

36

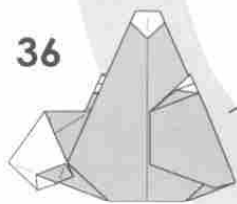

37

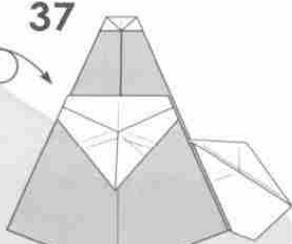

できあがり
Model completed.

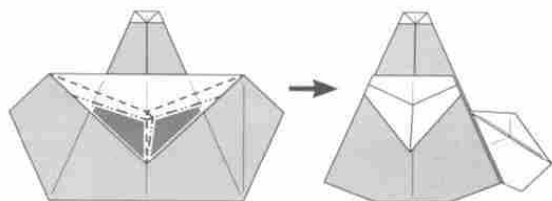

15-22で■部分に折り筋がつかない
ように折るとヒゲが綺麗に仕上がります
Try not to make crease lines within the
shaded area at 15-22 for cleaner finish.

상자안에 남자 Man in the box

by Oh KyungRan : korea

Diagram by Oh KyungRan

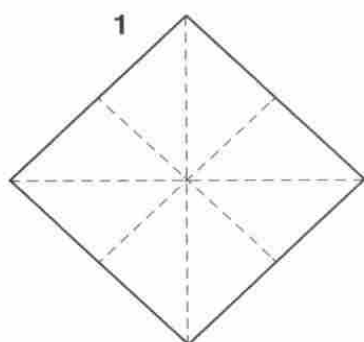

1

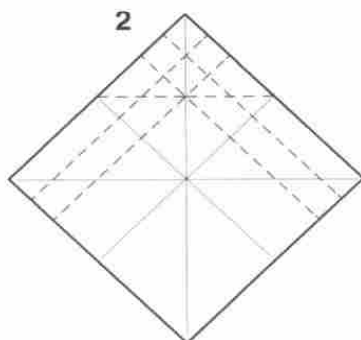

2

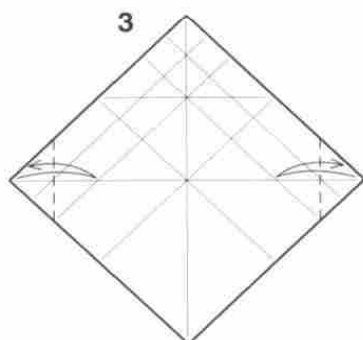

3

접었다 편다.
Fold and unfold

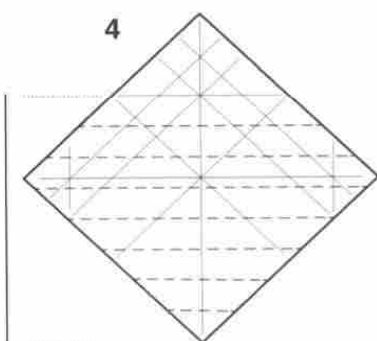

4

8등분하여 접었다편다.
Fold the lines(8 equal parts)

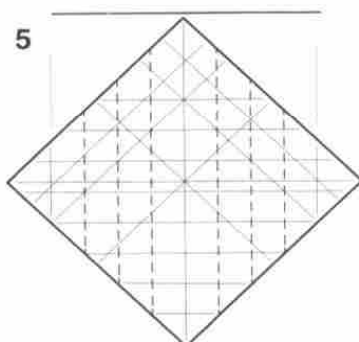

5

8등분하여 접었다편다.
Fold the lines(8 equal parts)

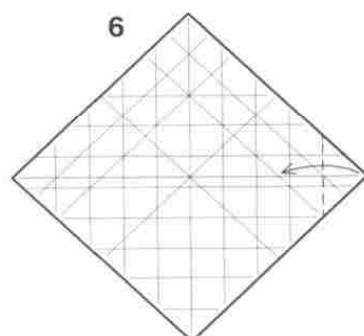

6

골짜기접기한다.
Valley fold

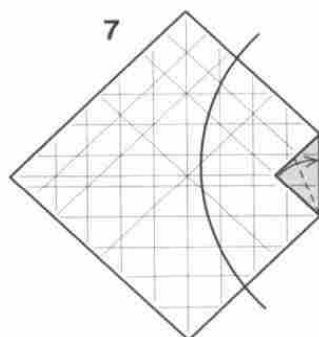

7

이등분하여 접는다.
Fold the triangle in half

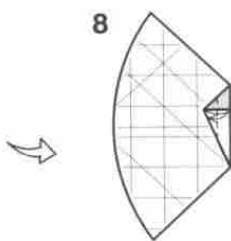

8

이등분하여 접었다편다.
Fold and unfold it in half

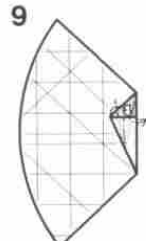

9

안쪽으로접기한다.
Inside reverse fold

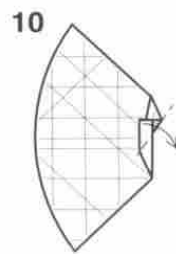

10

접어 내린다.
Valley fold

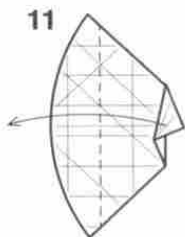

11
왼쪽으로 골짜기접기한다.
Fold the flap to the left

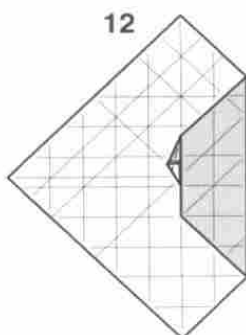

12
1/3등분하여 접는다.
Fold in 1/3 equal parts

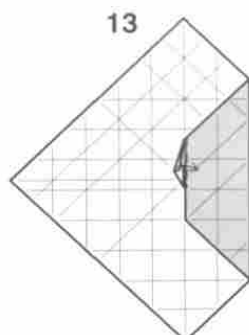

13
중심선을 따라 골짜기접기한다.
Valley fold along the center line

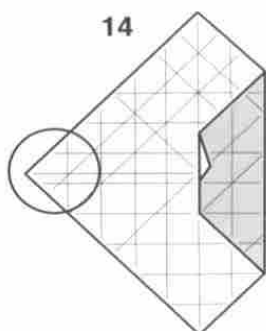

14
왼쪽도 6~13까지 같은 방법으로 접는다.
Repeat steps 6 to 13 on the left

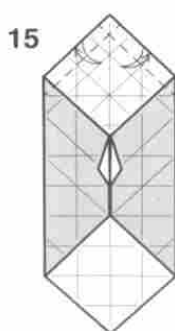

15
접었다 편다.
Fold and unfold

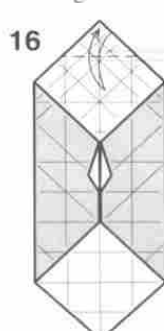

16
접었다 편다.
Fold and unfold

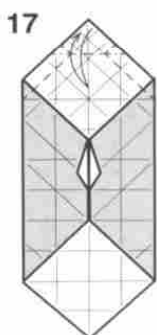

17
접었다 편다.
Fold and unfold

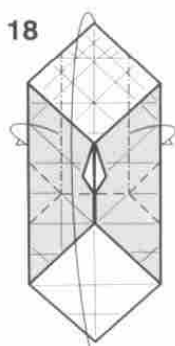

18
표시선처럼 모아서 접어내린다.
Fold the corner down

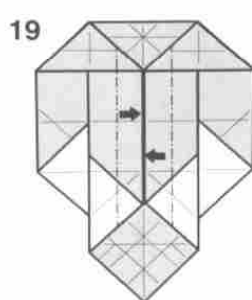

19
닫힌 함물접기
Closed sink

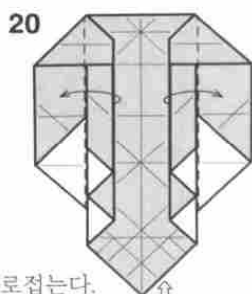

20
좌우로 접는다.
안쪽을 열어서 본다.
Valley fold to the right and left.
Open and see inside.

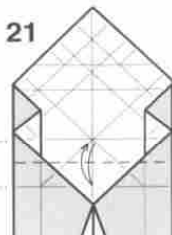

21
이등분하여 접었다 편다.
(여기부터 순서35까지 상반신)
Fold and unfold it in half.
(Upper body from here to step35)

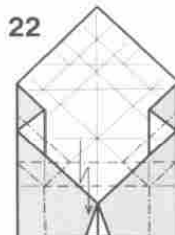

22
표시선을 잘 보고
계단접기하여 접었다 편다.
Fold as shown, Pleat fold

23-1

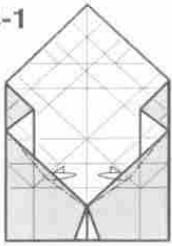

<23-1과 23-2를 동시에 접는다>
Fold 23-1 and 23-2 at the same time

23-2

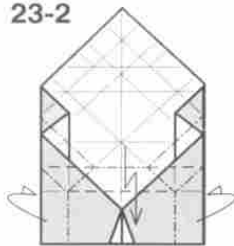

표시선을 잘 보고 계단접기한다.
Fold as shown. Pleat fold

24

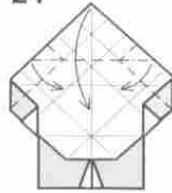

접어 내린다.
Fold the corner down

25



빼낸다.
Pull out the layer

26

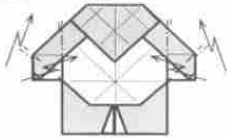

앞, 뒤 계단접기하듯이 동시에 접는다.
Fold front and back at the same time. pleat fold

27



머리 완성.
The head is done

28



가장 아래층 사이에서 한장을 꺼낸다.
Pull out the paper from between the bottom layers

29

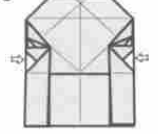

옆에서 한장을 꺼낸다.
Pull out the paper from the side

30

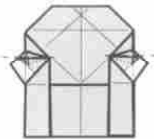

삼각형 부분을 위쪽 주머니에 끼워 넣는다.
Insert the triangle into the upper pocket

31

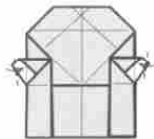

골짜기접기.
Valley fold

32

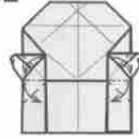

회전하듯이 접는다.
Swivel fold

33



뒷모습 완성
The back image is complete

34

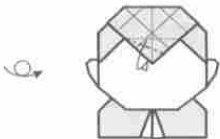

산접기
Mountain fold

35



앞모습 완성
The front image is complete

36

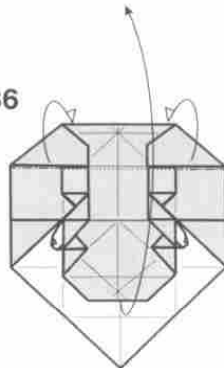

산접기한다.
Mountain fold

37

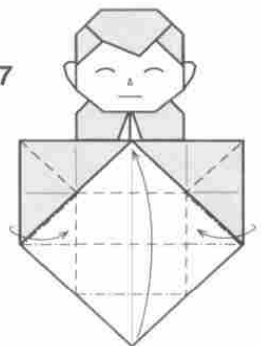

산접기선, 골짜기접기선을 잘 보며 보우트를 접는다.
Fold as shown. Make a boat .

38



한 장을 접어 올린다.

Fold one flap up

39

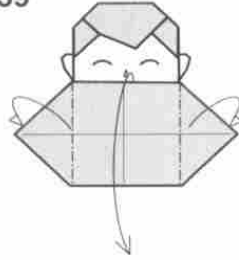

표시선처럼 접어 상자를 만든다.

Fold as shown. Make a box

40



상자 안에 직장인

Office worker in the box

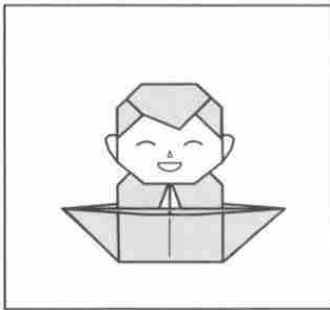

보우트 안에 남자 아이

Boy in the boat

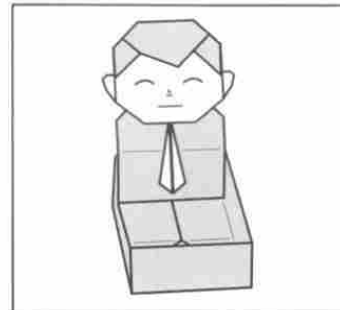

상자 안에 직장인

Office worker in the box

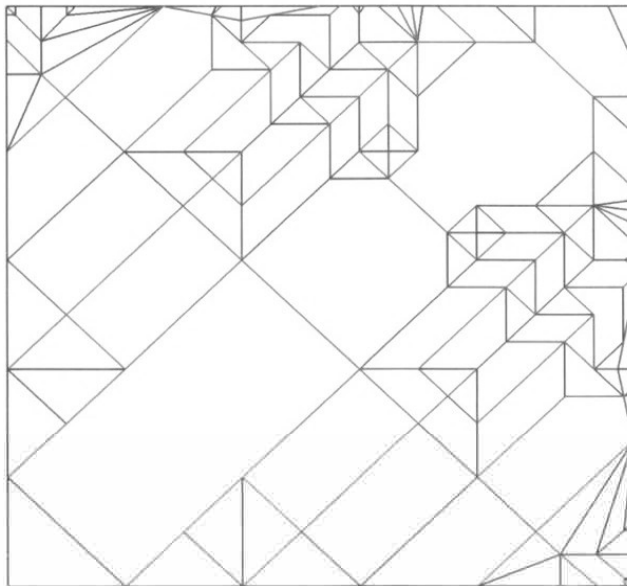

신랑, 신부

Groom bride

by Ko YiNyeo : Korea

Diagram by Ko YiNyeo

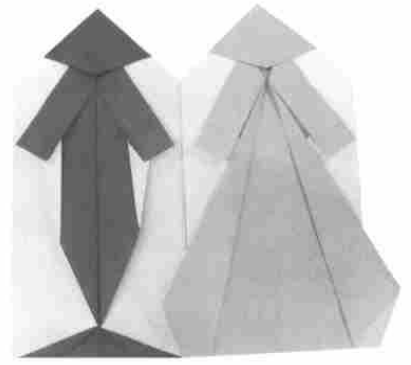

신랑

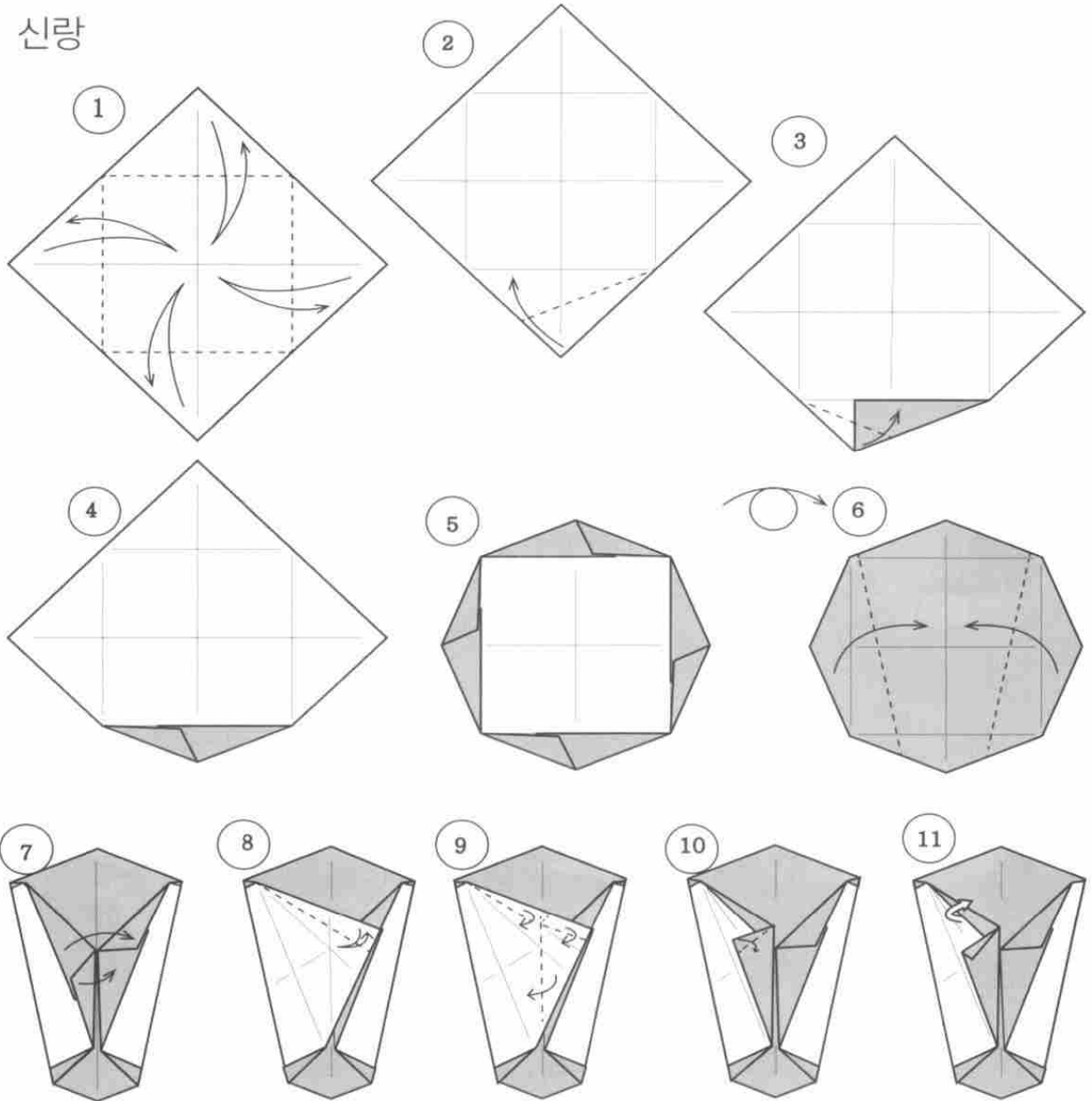

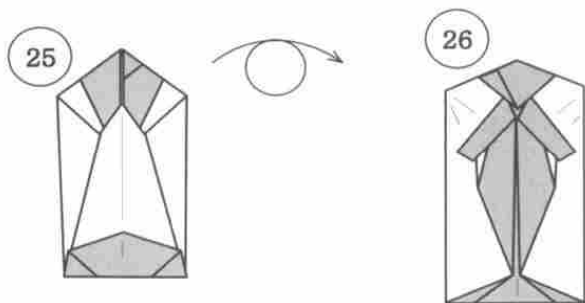
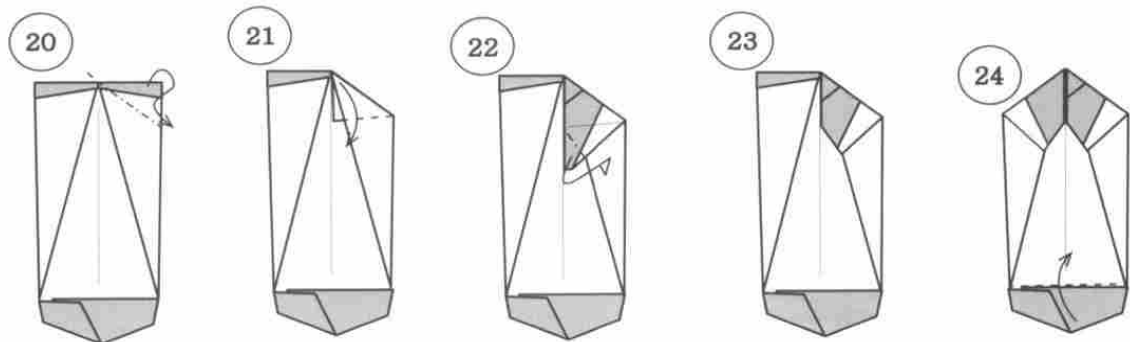
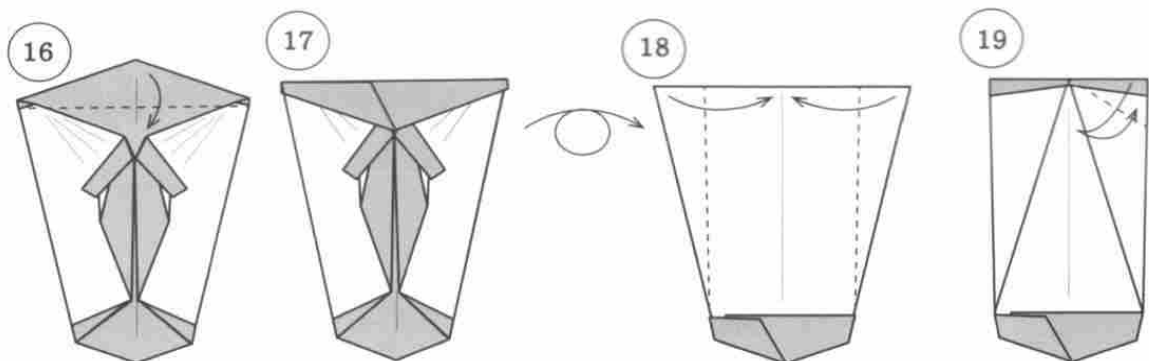
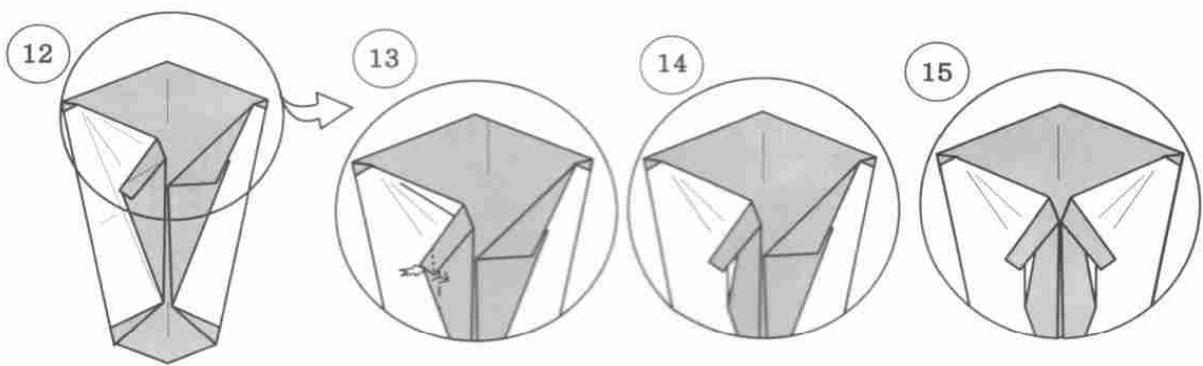

신부

24

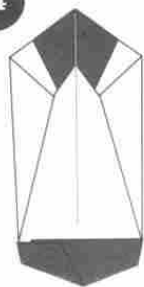

25

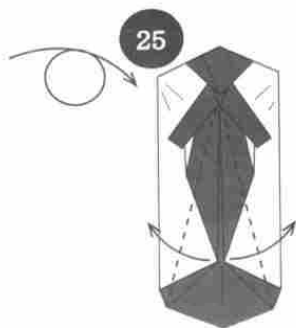

26

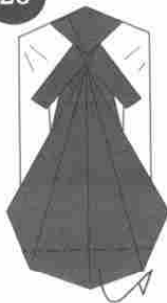

27

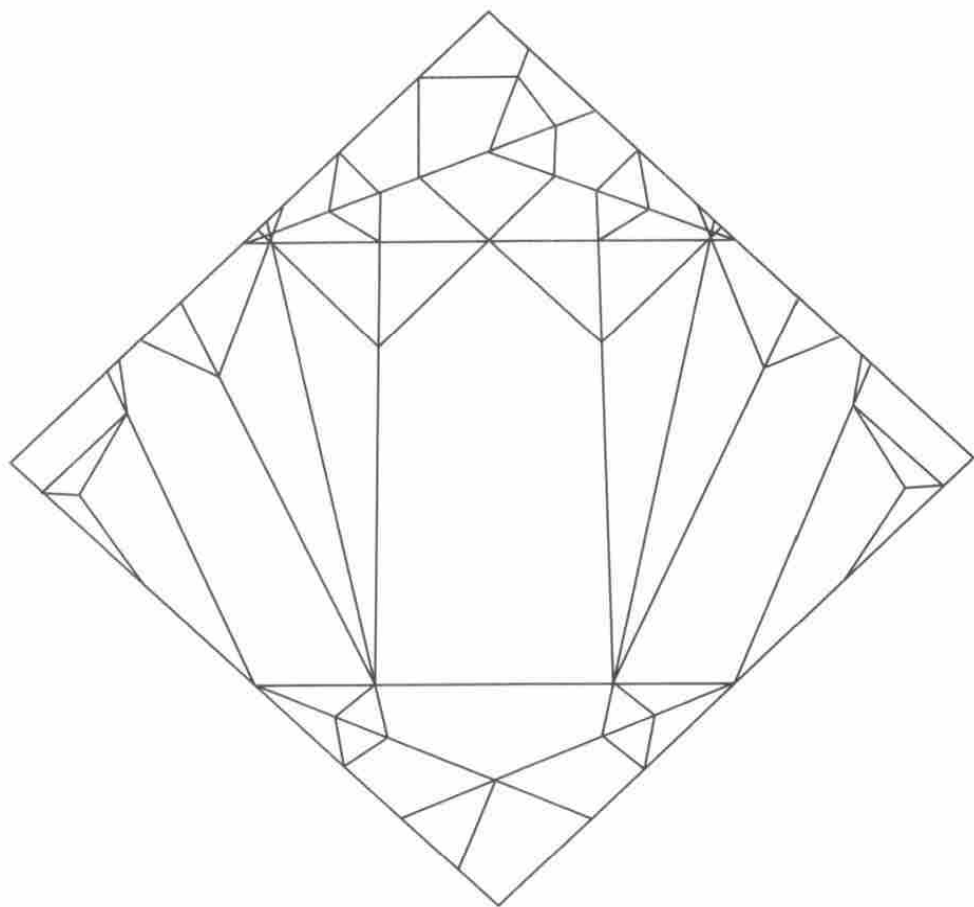

When devil speaks

by Leonardo Pulido Martinez : Colombia

Diagram by Leonardo Pulido Martinez

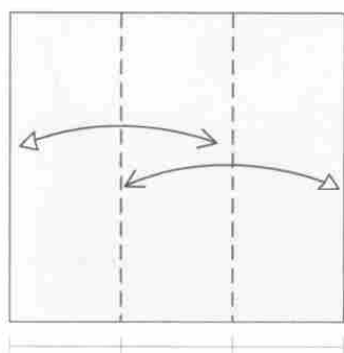
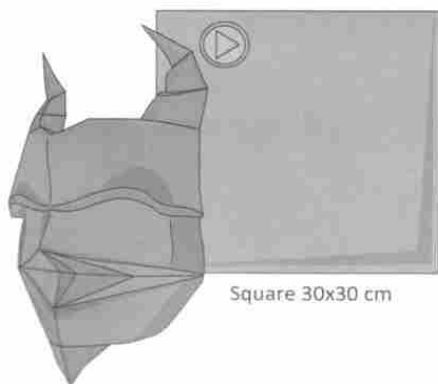

1
Pre-crease
in 3 parts

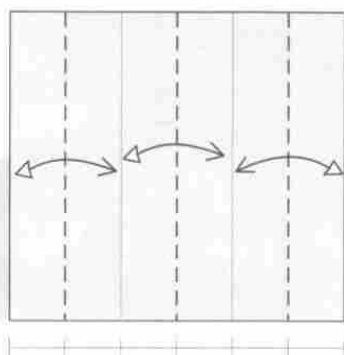

2
Precrease
(6 parts)

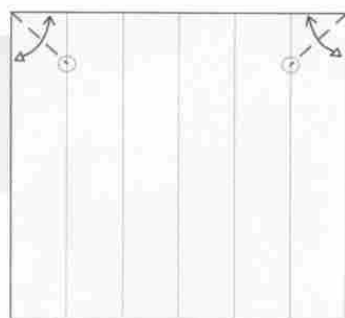

3
Precrease
45°

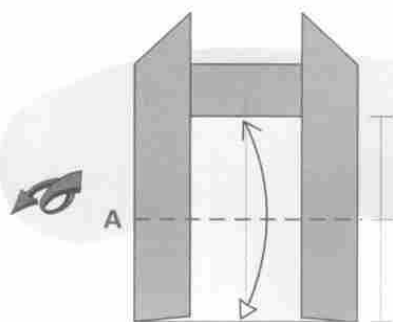

4
Precrease and
turn over

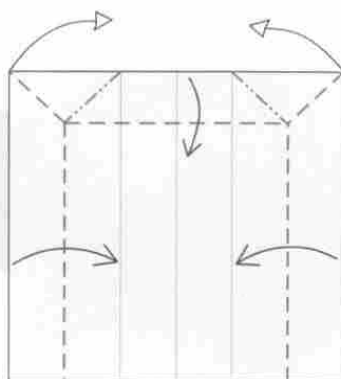

5
Fold by marks
as show

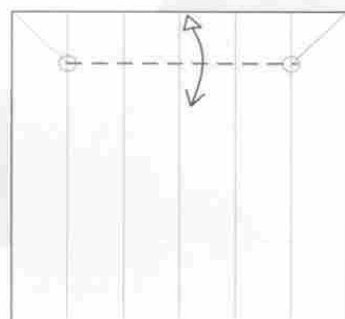

6
Precrease in Valley

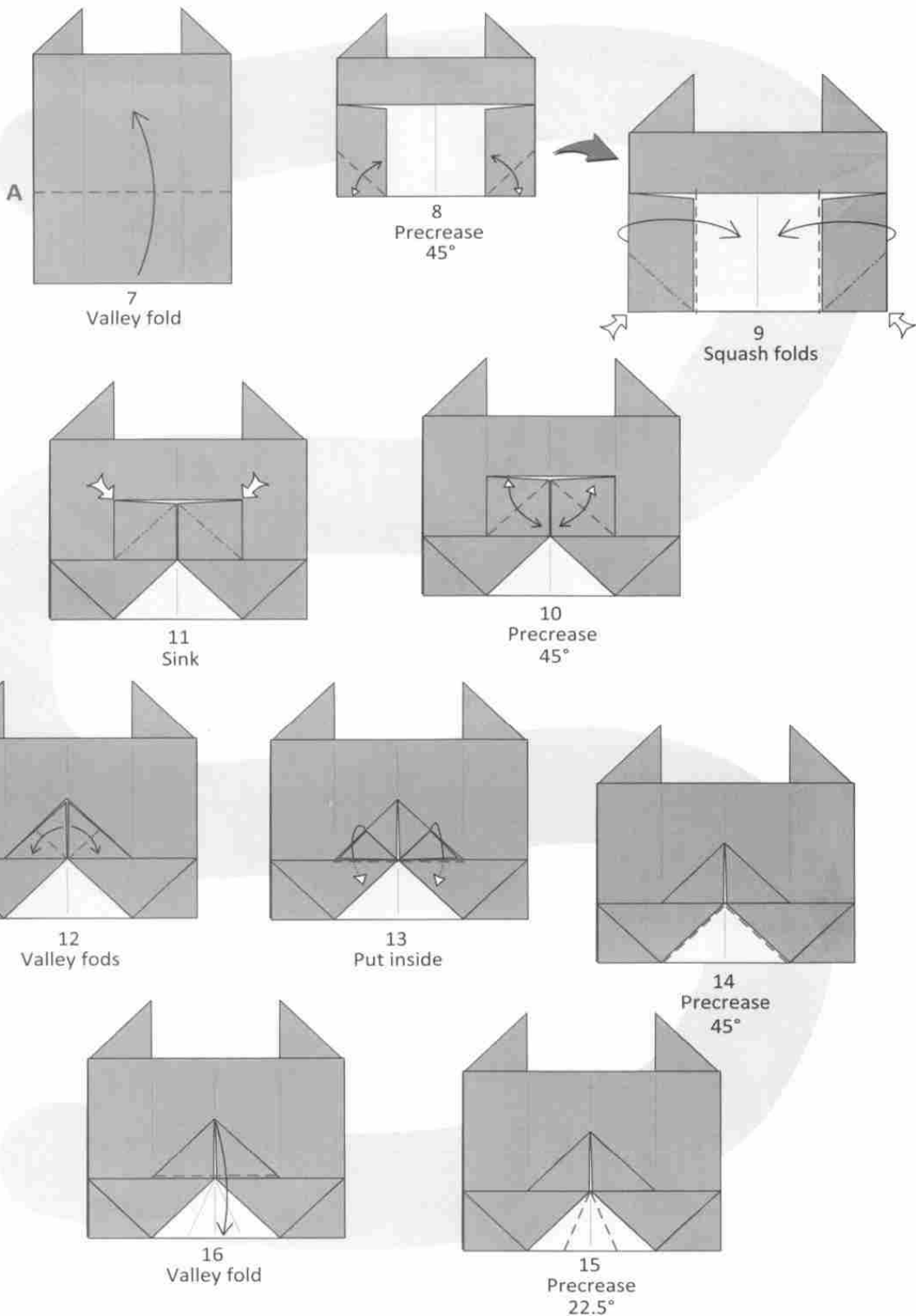

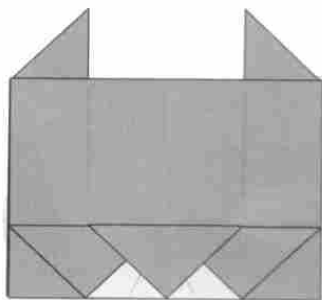

17
Turn over

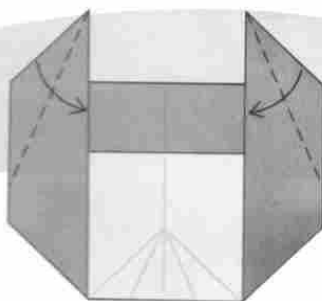

18
Valley folds
22.5°

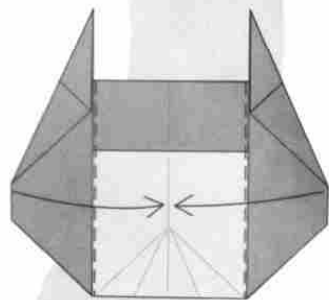

19
Valley folds

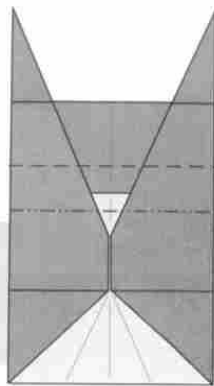

20
Pleat fold
as show

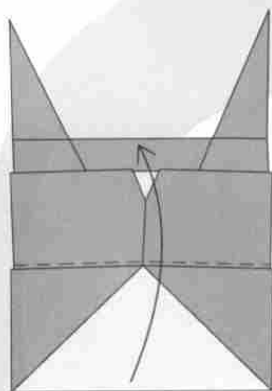

21
Valley fold

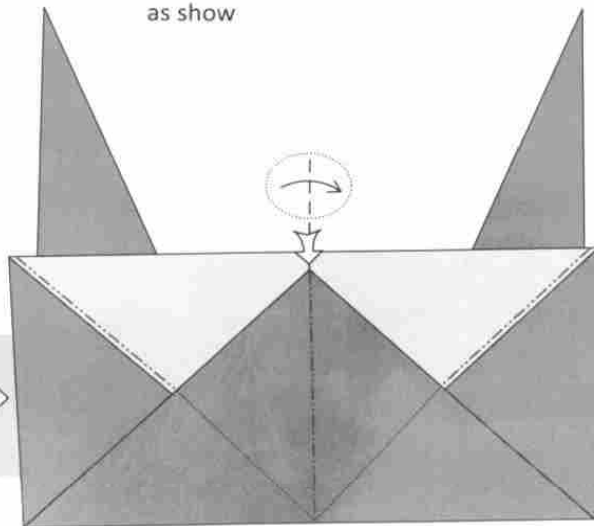

22
Sink the middle layer at
same time as folding
in half as show
(just do it)

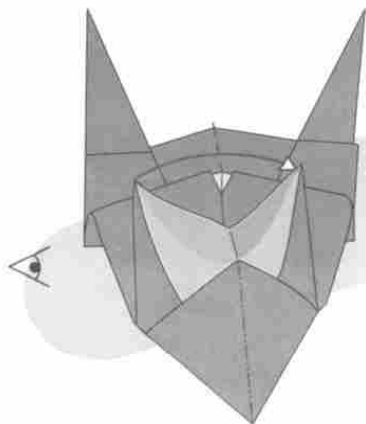

23
Intermediate step

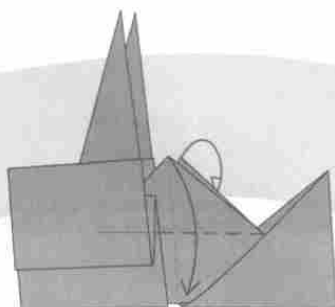

24
Fold as show
(mountain fold behind)

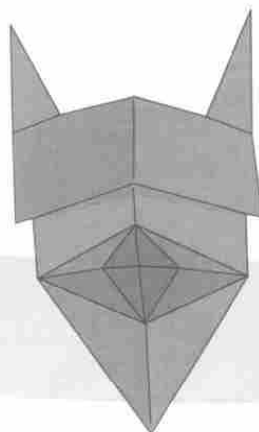

26
Turn over

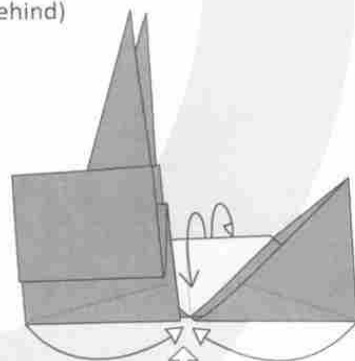

25
Fold by marks
(open the mouth as show)
(use marks step 15)

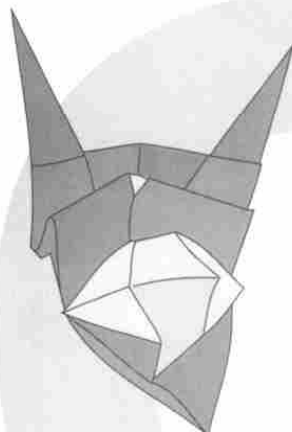

27
Turn over

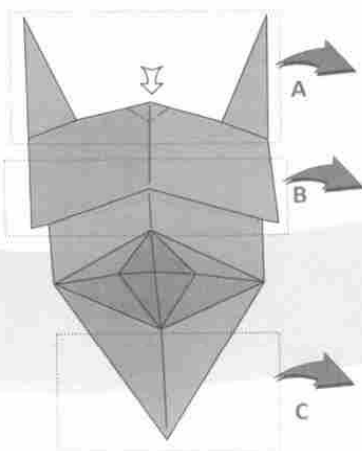

28
Sink

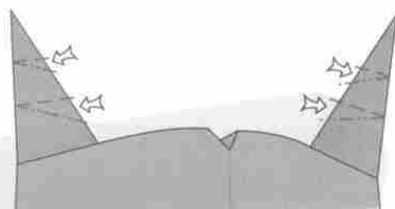

29
A) Crimp folds

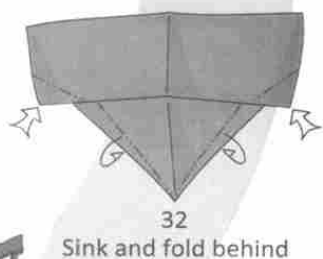
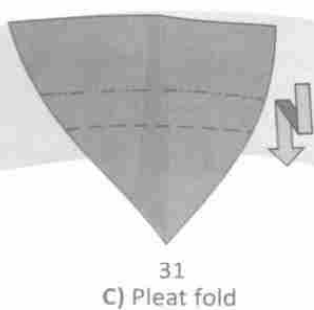
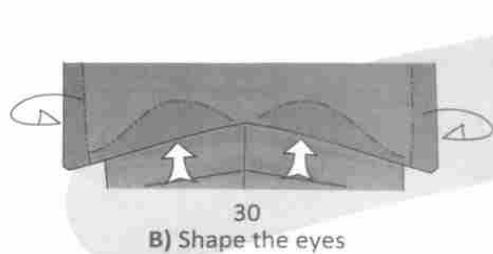

33
Put the fingers as shown,
and moving them,
the devil speaks



34
Finished model

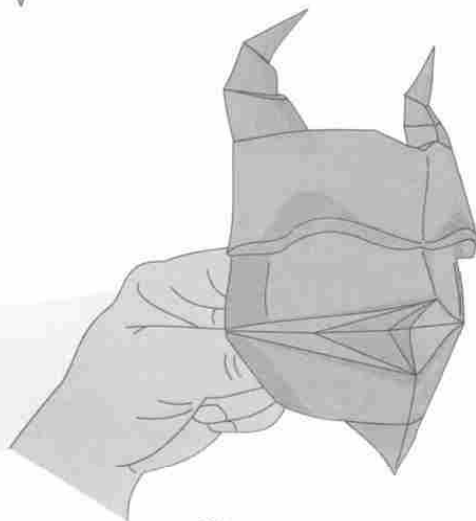

새싹 Sprout

by Kim HyunJun : Korea

Diagram by Kim HyunJun

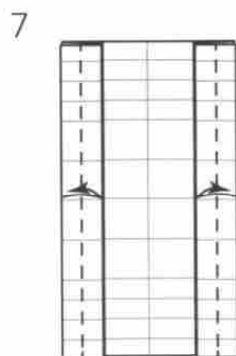
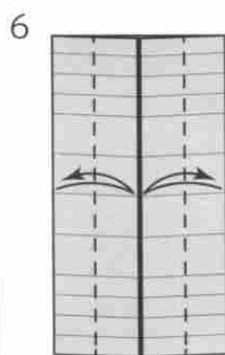
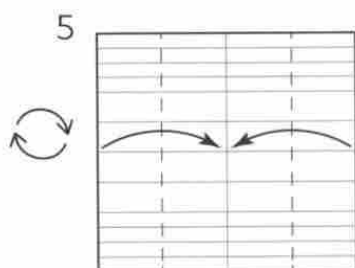
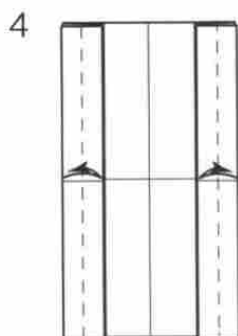
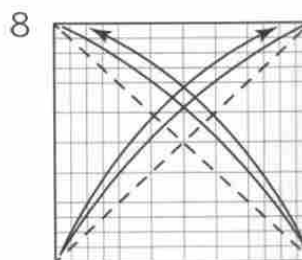
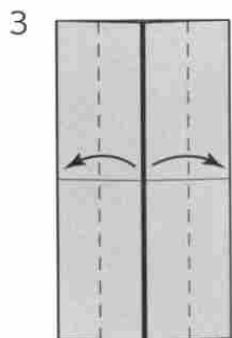
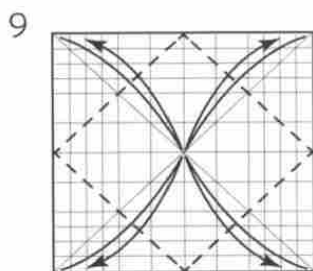
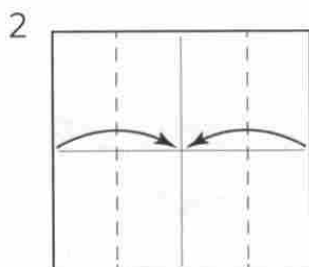
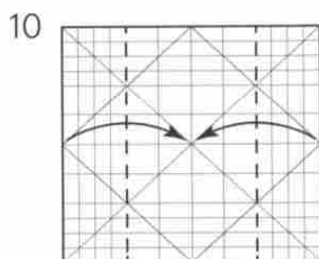
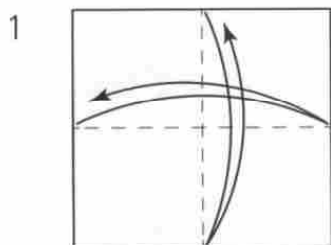
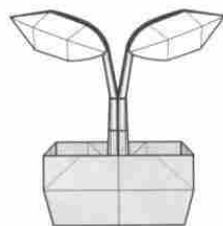

모두 펼치세요.

모두 펼치세요.

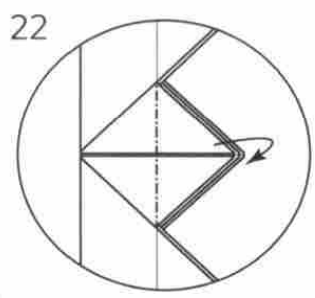
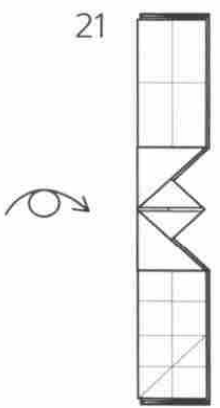
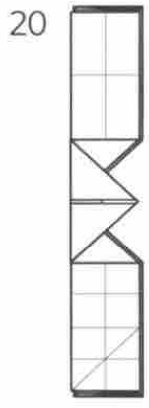
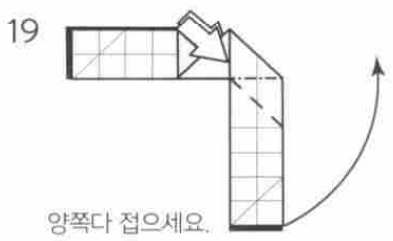
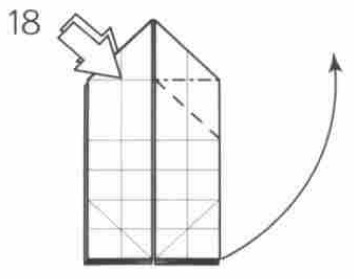
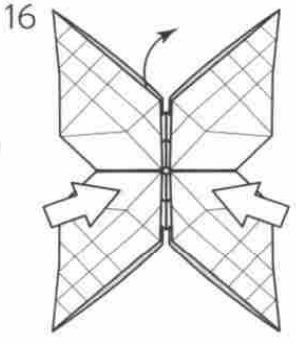
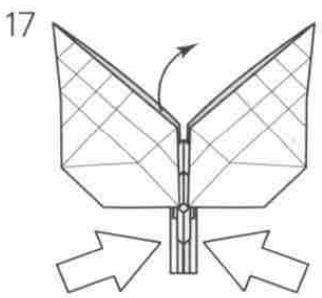
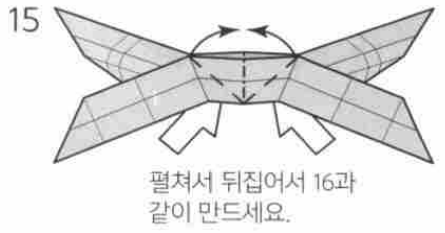
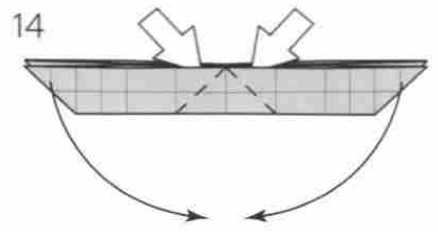
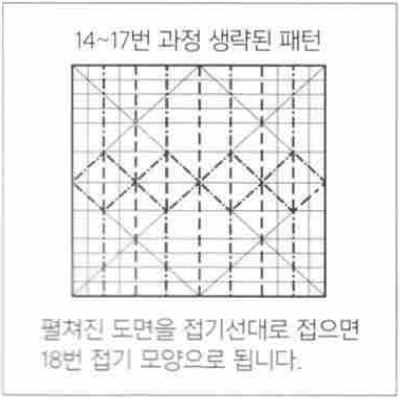
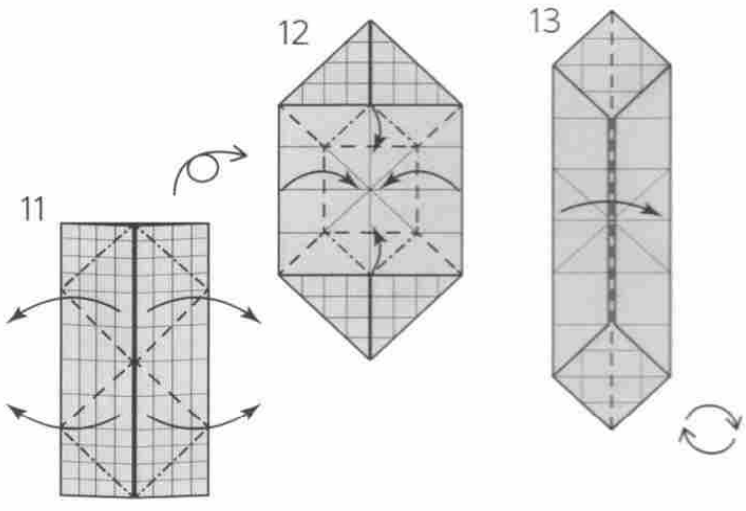

앞쪽만 잡아 뺐다가
다시 접으세요.

23

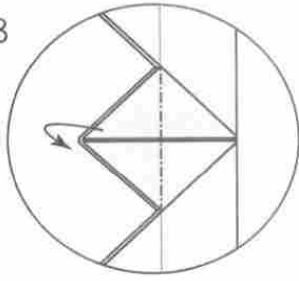

24

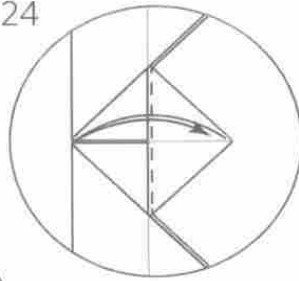

25

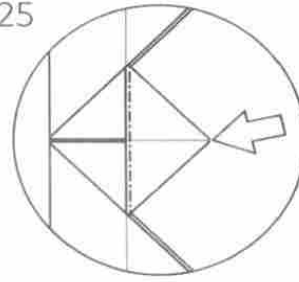

26

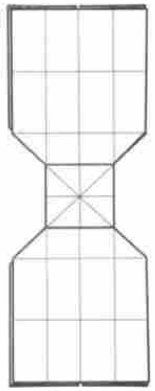

27

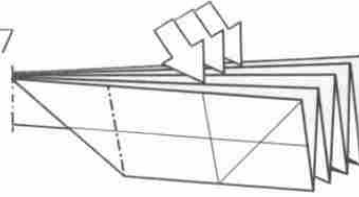

펼쳐서 28번처럼 입체로 만드세요.

28

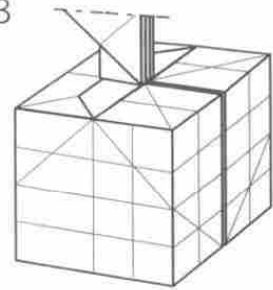

29

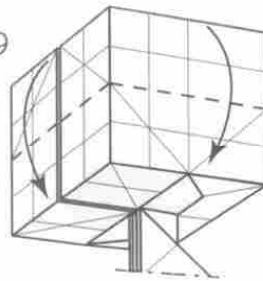

30

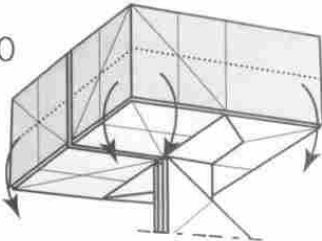

한 칸만 내려 접으세요.

31

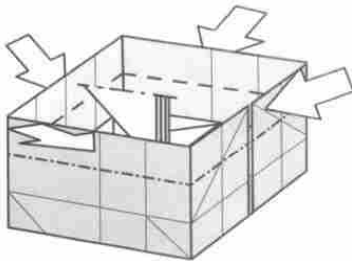

32

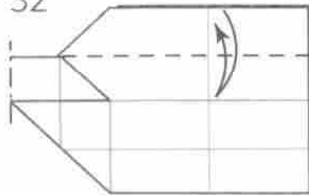

새싹잎 한쪽면을 펼친후 접었다
펴세요. 반대면도 같은 방법으로
접으세요.

33

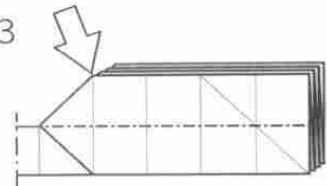

밀어넣으세요. 나머지 세곳도
같은 방법으로 접으세요.

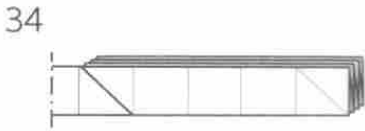
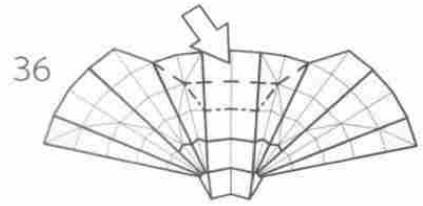
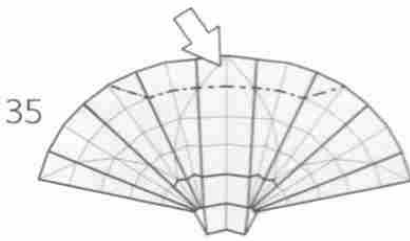

35번처럼 펼치세요.

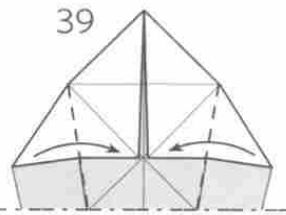
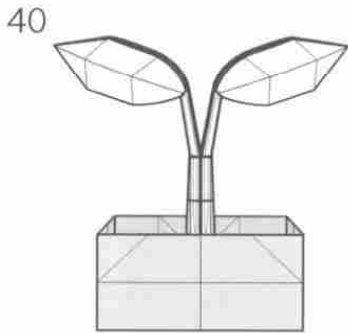
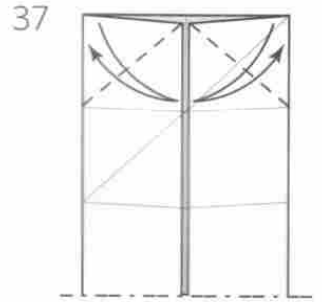

반대 새싹잎도 37-39와 같은 방법으로 접으세요.

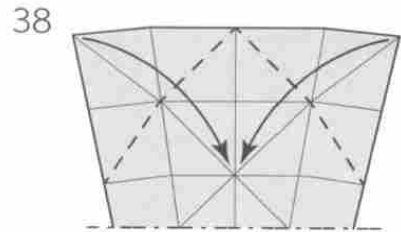

새싹잎 부분을 펼쳐 도면대로 접으세요.

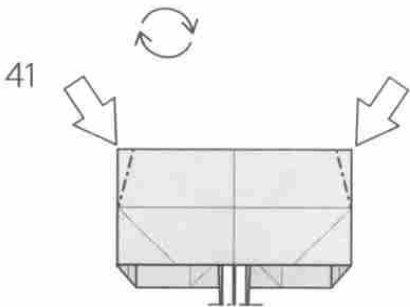

모두 안쪽으로 접기하세요.

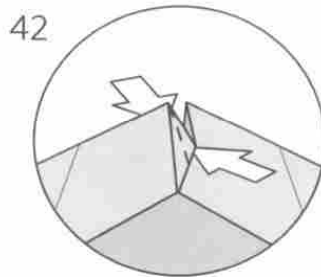

안에서 접어서 벌어지지 않게 고정하세요.

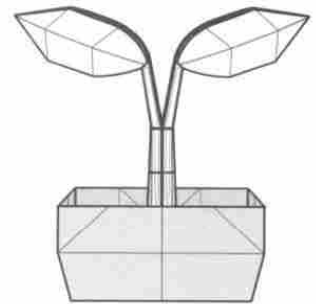

완성

장미 Rose

by Katsuhiko Yamakita : Japan

Diagram by Katsuhiko Yamakita

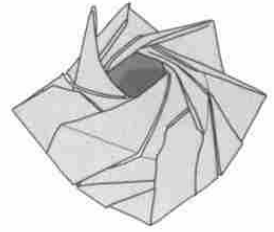

1

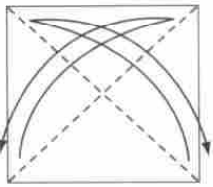

2

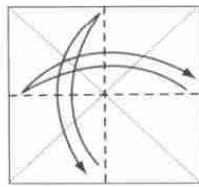

3

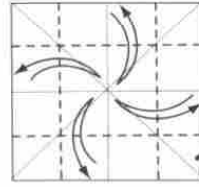

4

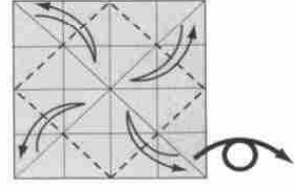

5

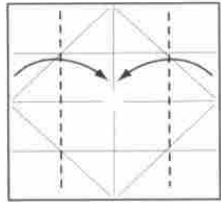

6

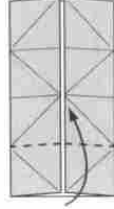

7

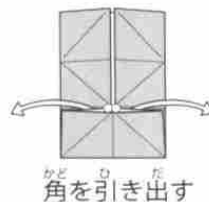

かどひだす
角を引き出す

8



ひらいてつぶすように折る

9

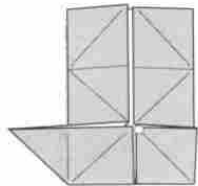

ひだしてつぶす
左側も同様に折る
(Repeat 8)

10

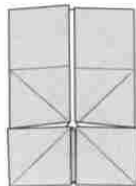

11

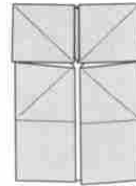

ひだしてつぶす
同様に折る
(Repeat 6-9)

12

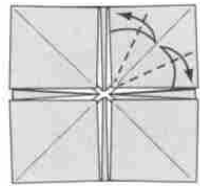

13

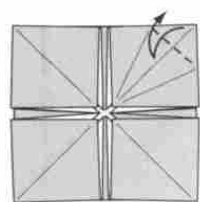

14

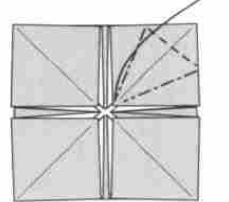

かべを
花弁折り

15

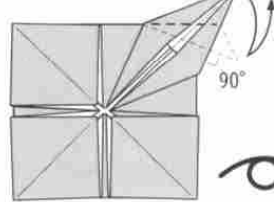

16

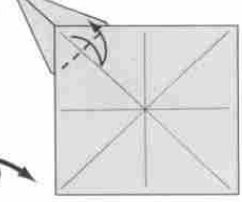

しっかり折り目をつける

17

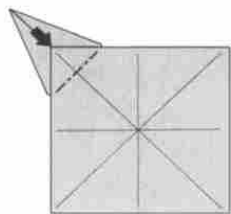

沈め折り (Open Sink)

18

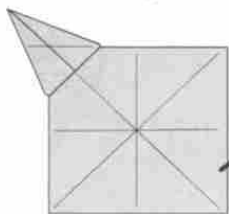

19

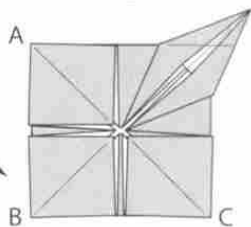

ABCも同様に折る
(Repeat 12-18)

20

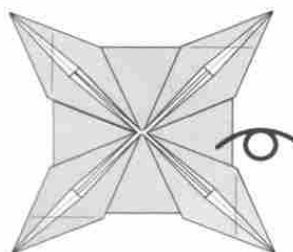

21

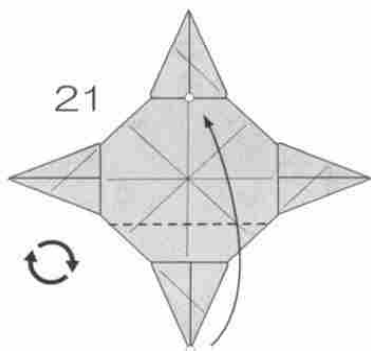

22

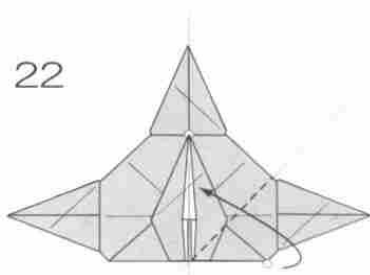

23

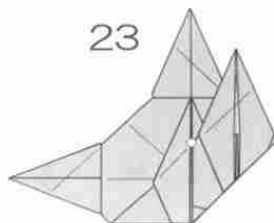

21まで戻す

24

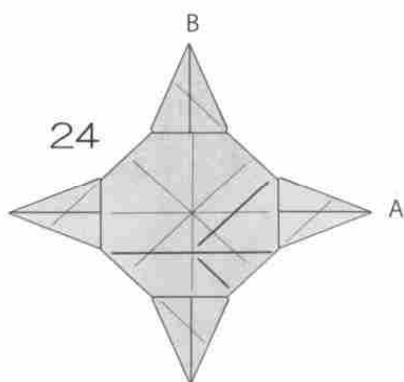

ABCも同様に折る
(Repeat 21-23)

25

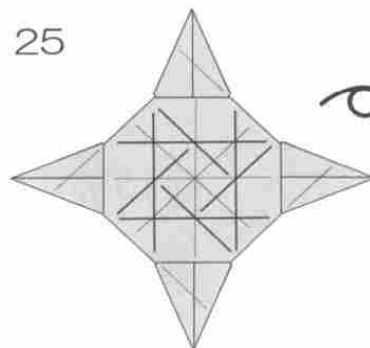

26

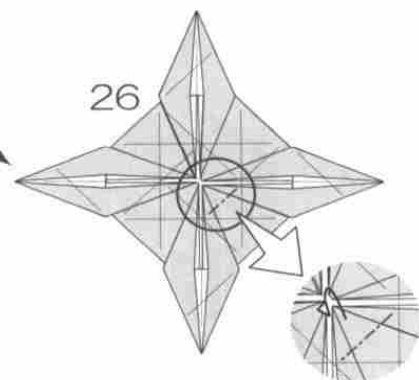

27

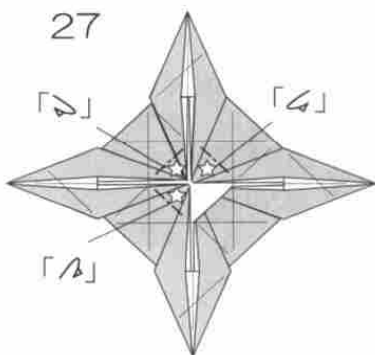

28

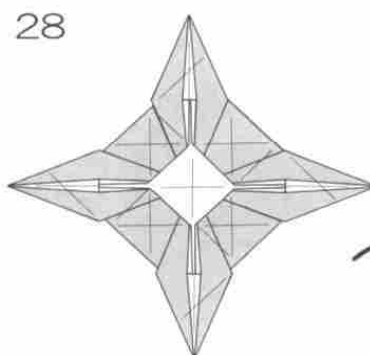

29

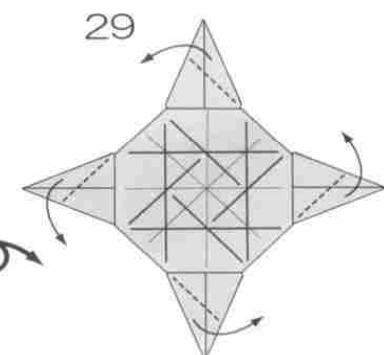

30

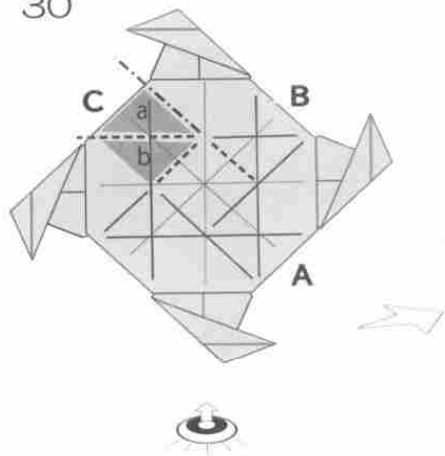

31

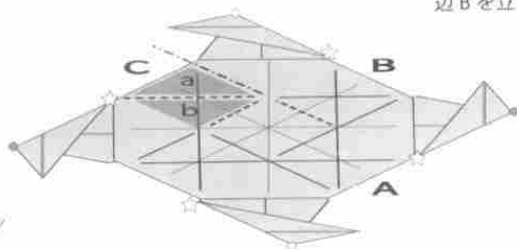

面 a と面 b を合わせながら
図に示した折り筋を使い辺 C と
辺 B を立てるように起こす

32

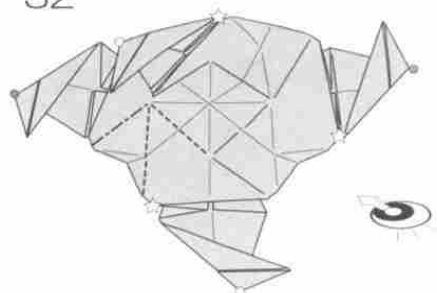

33

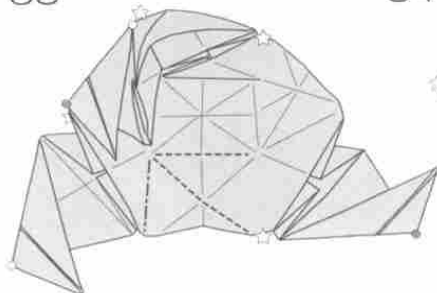

34

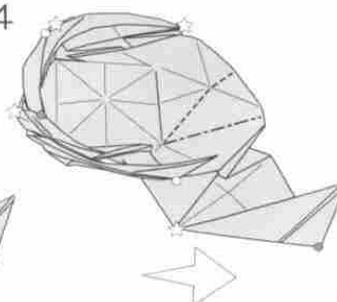

35

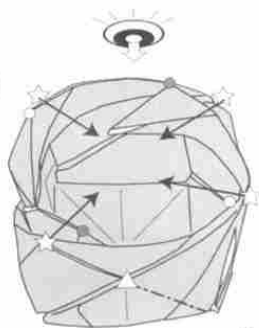

36

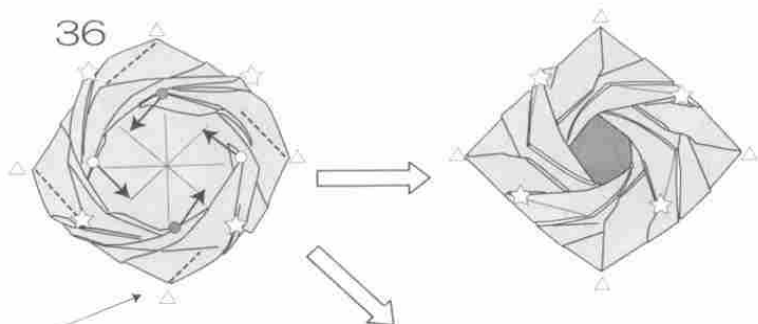

단단히 짚는 (しっかり折る)

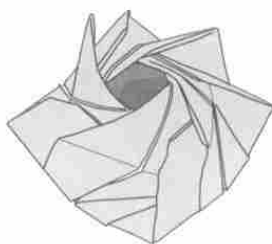

완성 (完成)

악어 입 Crocodile Mouth

by Shin HanKyo : Korea

Diagram by Shin HanKyo

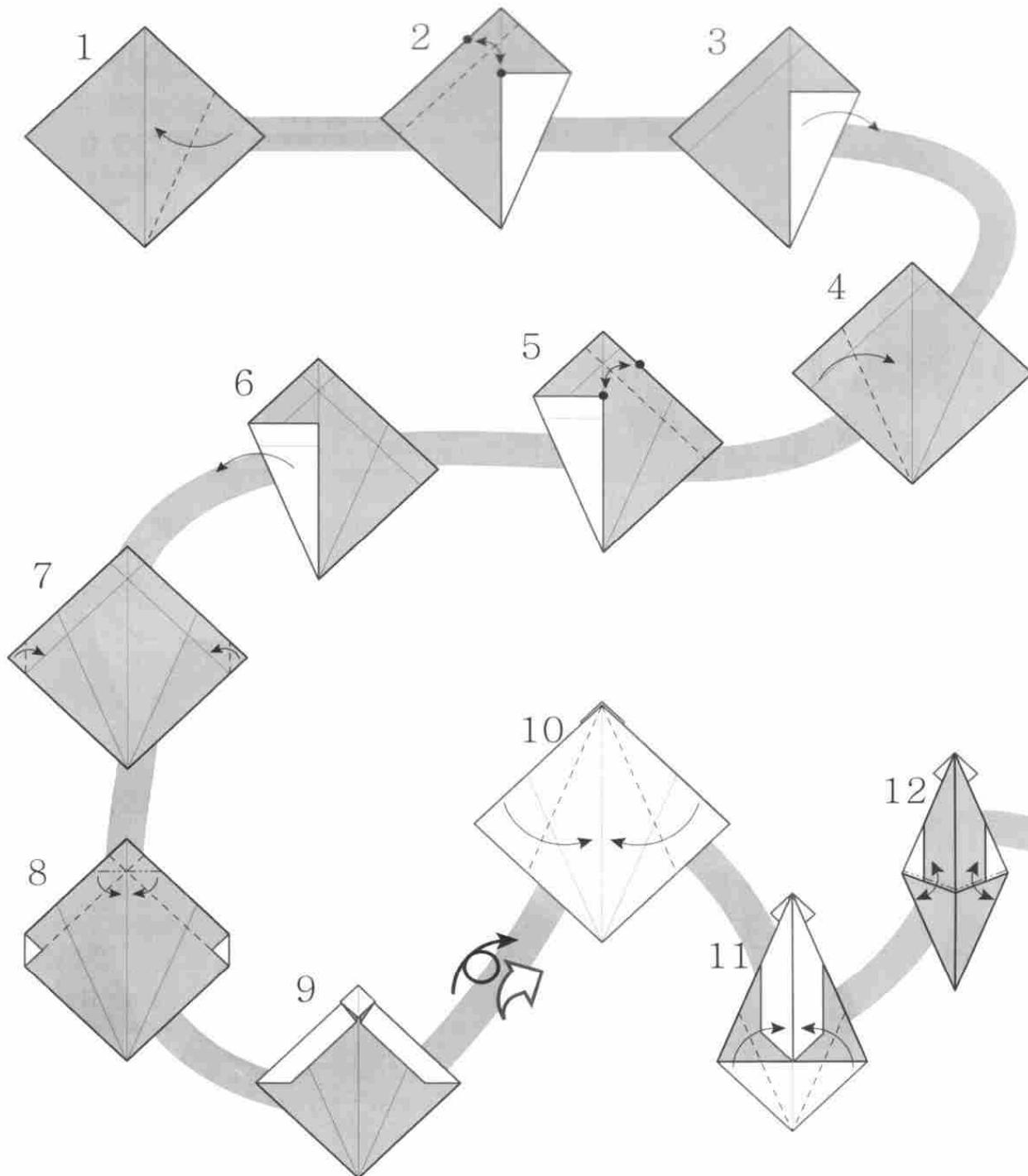
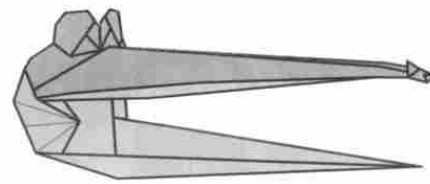

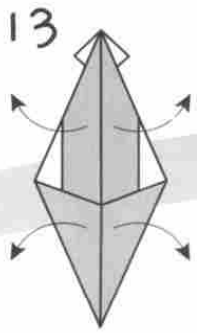

13. 펼치세요.

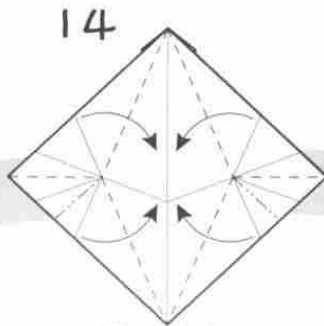

14. 선을 따라서
물고기 기본형을 접기를
접으세요.

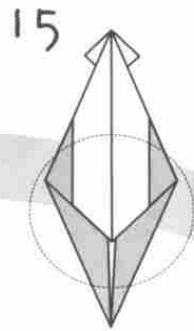

부분확대

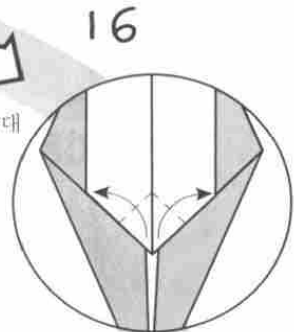

16. 모서리를 맞춰
접으세요.

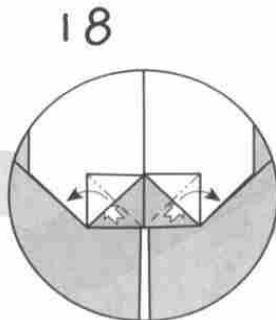
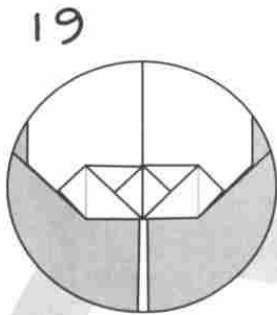

18. 펼쳐눌러 접으세요.

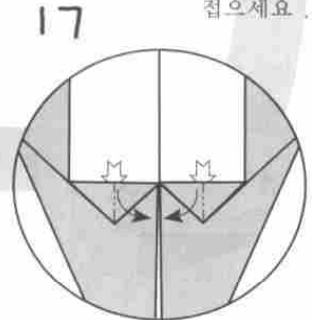

19. 펼쳐눌러 접으세요.

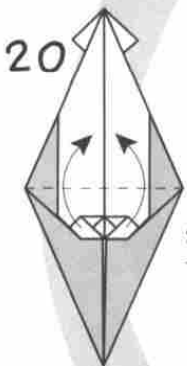

20. 선을 따라 위로
올려 접으세요.

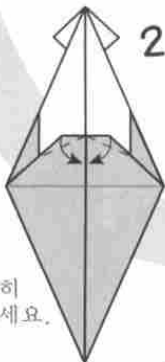

21. 비스듬히
내려 접으세요.

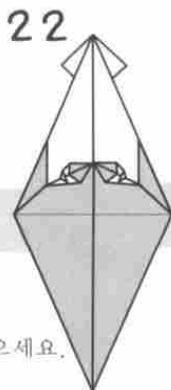

22. 뒤집으세요.

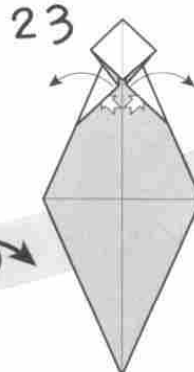

23. 양옆으로
꺼내어 펼치세요.

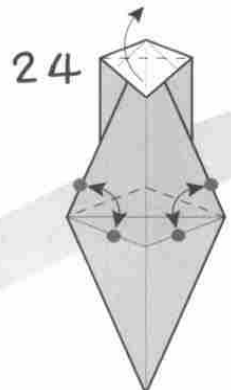

24. 점과 점을 맞춰
접어 접기선을
만드세요.

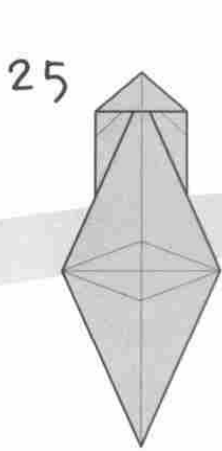

25. 뒤집으세요.

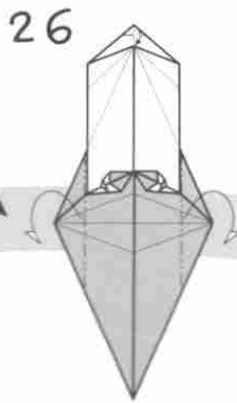

26. 선을 따라서
접으세요.

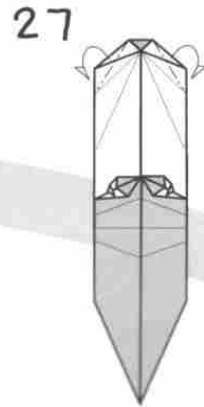

27. 선의 위치를
잘 보고 접으세요.

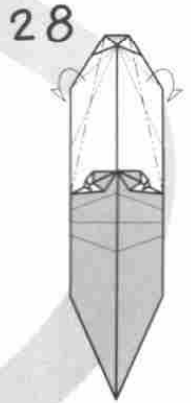

28. 선의 위치를
잘 보고 접으세요.

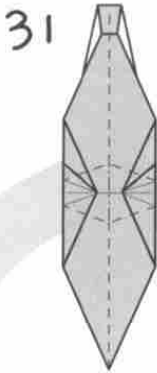

31. 선을 따라
입체를 만드세요.

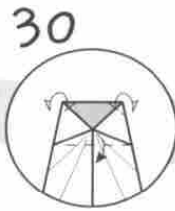

30. 모서리를
조금 접고
뒤집으세요.

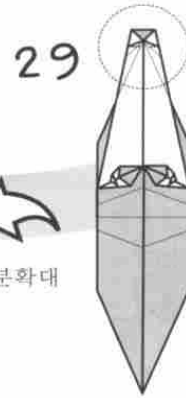

부분확대

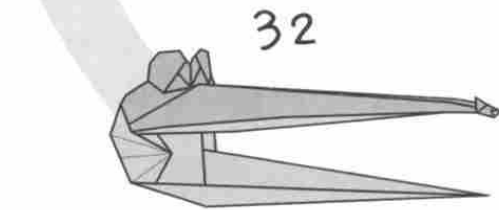

32

VANILLA 99

by Paul Jackson : Israel

Diagram by Paul Jackson

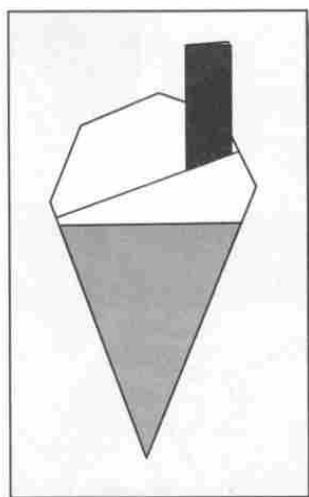

Everyone likes an ice cream.
Everyone licks an ice cream!
In England, where I'm from, ice creams are sold in cones. As a special treat, a vanilla ice cream is known as a '99' when a chocolate flake is included with the ice cream (why '99', I'm unsure. I guess it just sounds good). This design uses just mountain and valley folds to create the cone. Finding a simple way to create an abundant amount of ice cream on the cone was tricky. The result you see here is slightly asymmetric, but I think not enough to unbalance the design. Fold on a hot day!

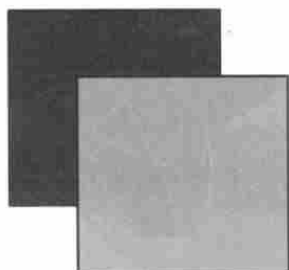

Use two squares of 15cm kami paper, preferably orange and brown.

CONE

1

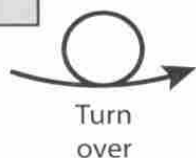

2

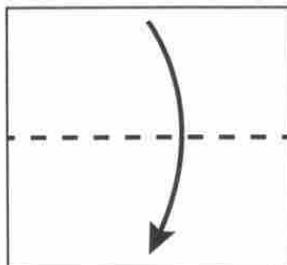

3

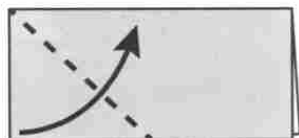

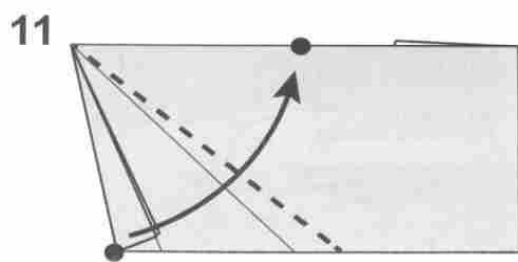
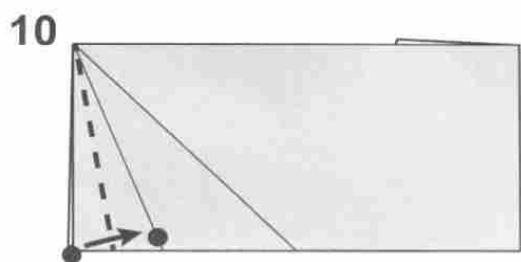
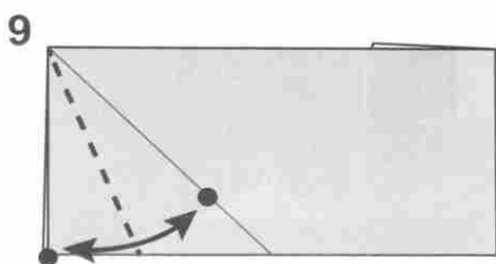
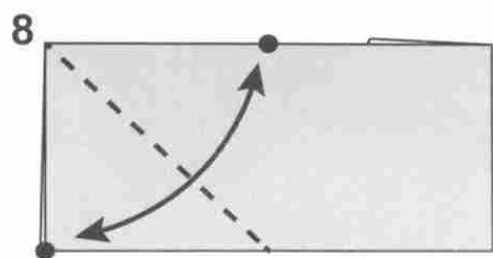
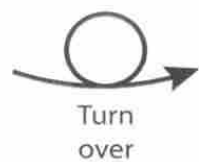
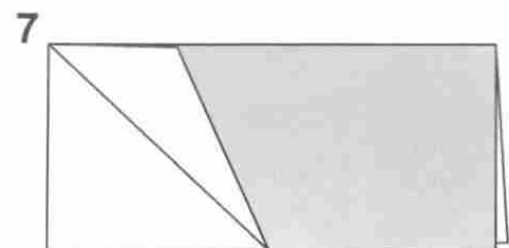
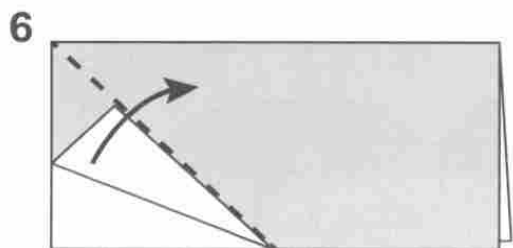
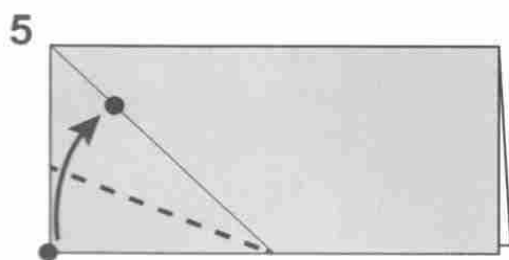
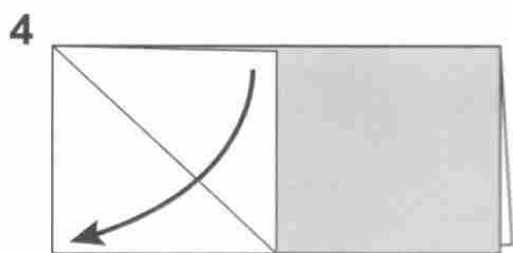

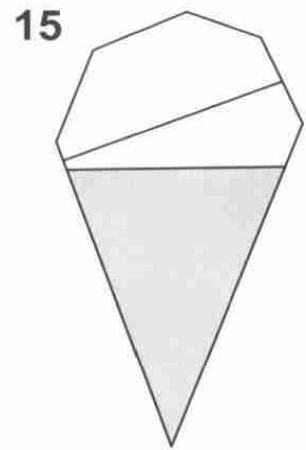
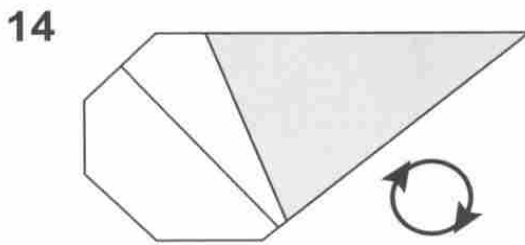
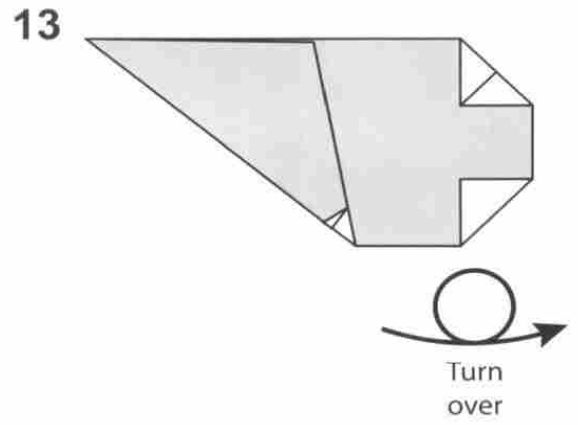
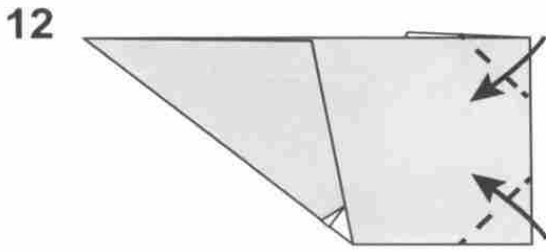

FLAKE

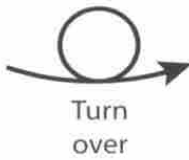
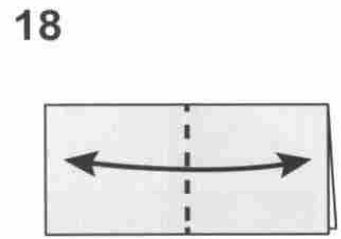
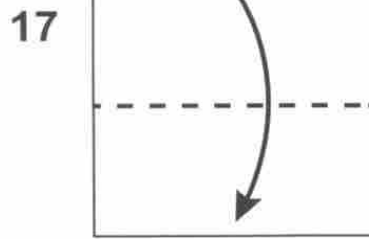
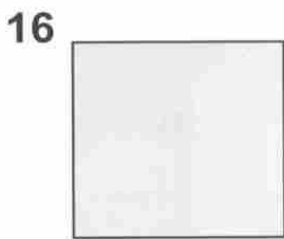

19

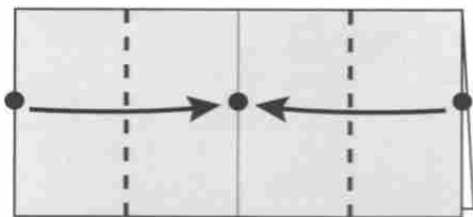

20

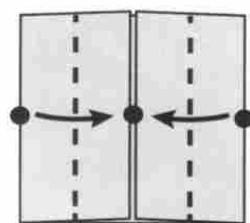

21

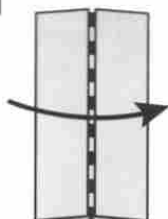

22



23

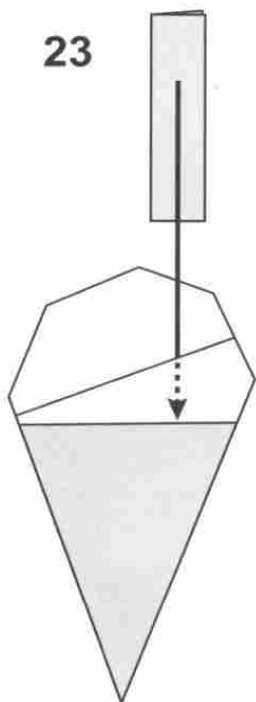

24

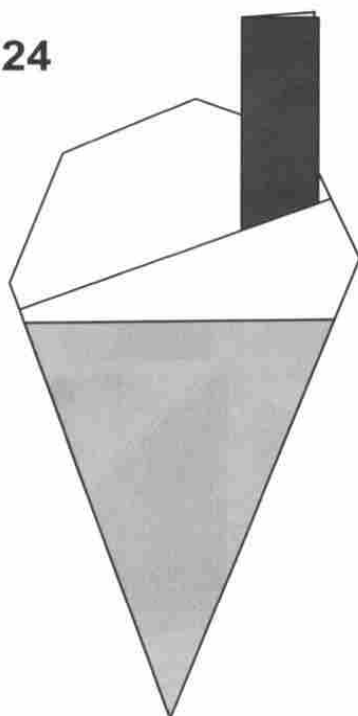

뚜껑이 있는 삼각 쟁반 Triangular Tray with Lid

by Makoto Yamaguchi : Japan

Diagram by Makoto Yamaguchi

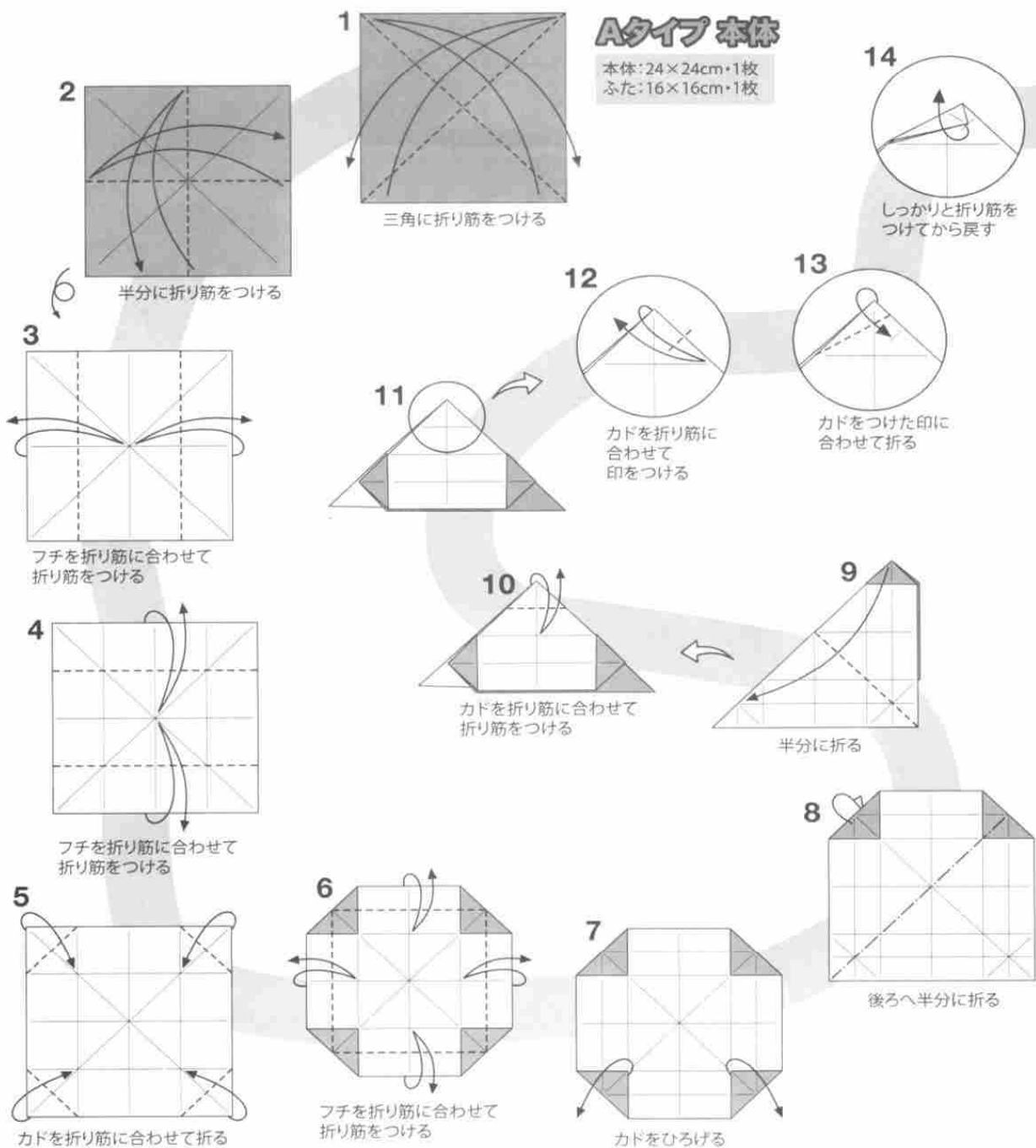

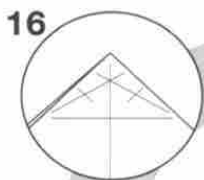

8の形までひろげる

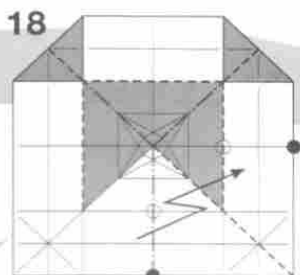

カドをつまんで■の部分が出っ張るようにしながら段折りして立体にする

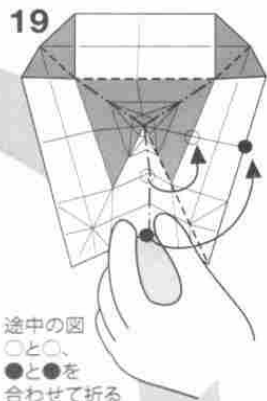

途中の図
○と○、
●と●を
合わせて折る

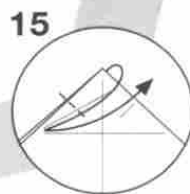

反対側も
12~14と
同じように
折り筋をつける

■の部分20の
形になるようにする

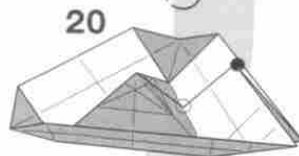

中心が図のような三角錐になる



図のようにつまんで
折りたたむ

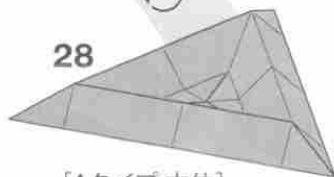

[Aタイプ 本体]
できあがり
[ふた]の折り方はP.118

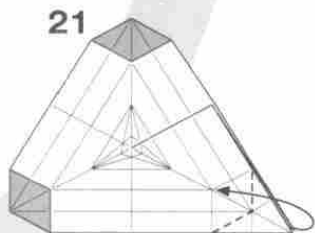

カドをまとめてついている
折り筋で折る



フチを
つまむようにして
中心が平らになるように
手前に折りたたむ

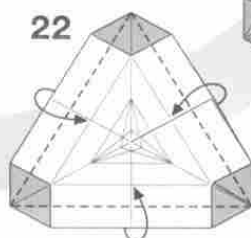
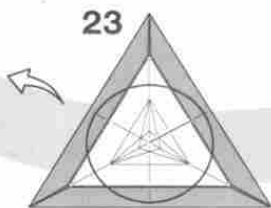

フチをついている
折り筋で折り込む

Bタイプ 本体

本体: 24×24cm・1枚
ふた: 16×16cm・1枚

[Aタイプ 本体]の
4まで折ってから始める

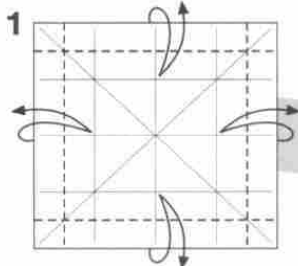

フチを折り筋に合わせて
折り筋をつける

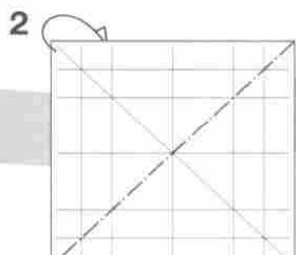

後ろへ三角に折る

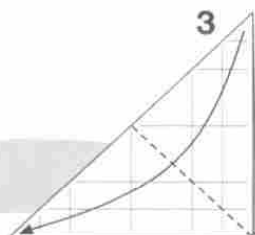

半分に折る

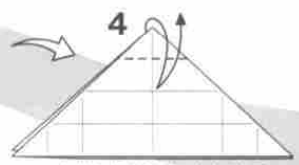

カドを折り筋に合わせて
折り筋をつける

14

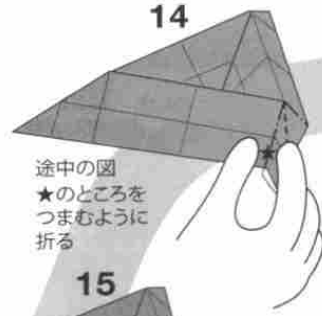

途中の図
★のところを
つまむように
折る

13

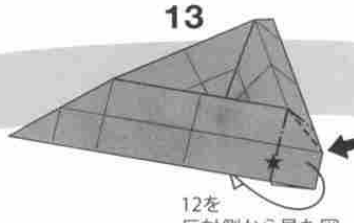

12を
反対側から見た図

12



ついている
折り筋でフチを
起こしながら引き寄せ
るように折る

15



折ったところ

21

【ふた】の折り方は
P.118



【Bタイプ本体】
できあがり

11



ついている折り筋で
フチを内側に折り込む

16

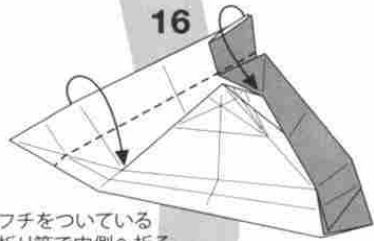

フチをついている
折り筋で内側へ折る

20

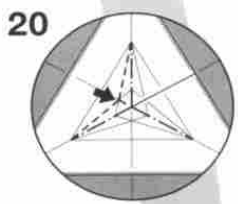

【Aタイプ本体】の
24~27と
同じように折る

10

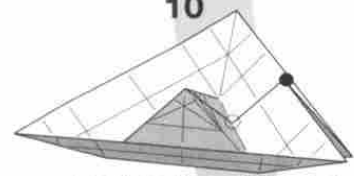

中心が図のような三角錐になる

17

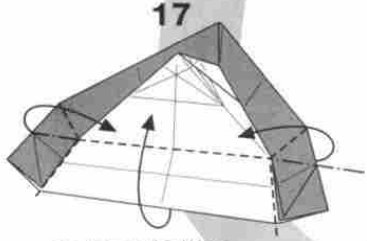

ついている折り筋で
フチをを起こしながら
引き寄せるように折る

19

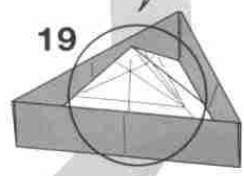

フチを
ついている
折り筋で
内側へ折る

9

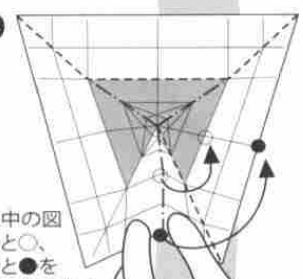

途中の図
○と○、
●と●を
合わせて折る

18

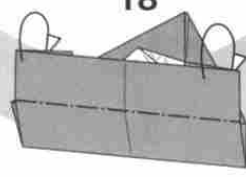

フチを
ついている
折り筋で
内側へ折る

8

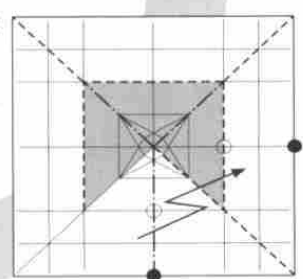

■の部分
が10の
形になるように
する

カドをつまんで■の部分
が出張るようにしながら
段折りして
立体にする

5

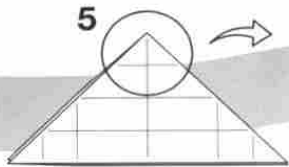

6

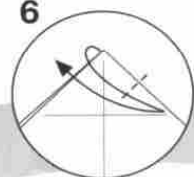

【Aタイプ 本体】の
12~16と同じに折る

7



全部ひろげる

Gタイプ 本体

本体:20×20cm
ふた:18×18cm

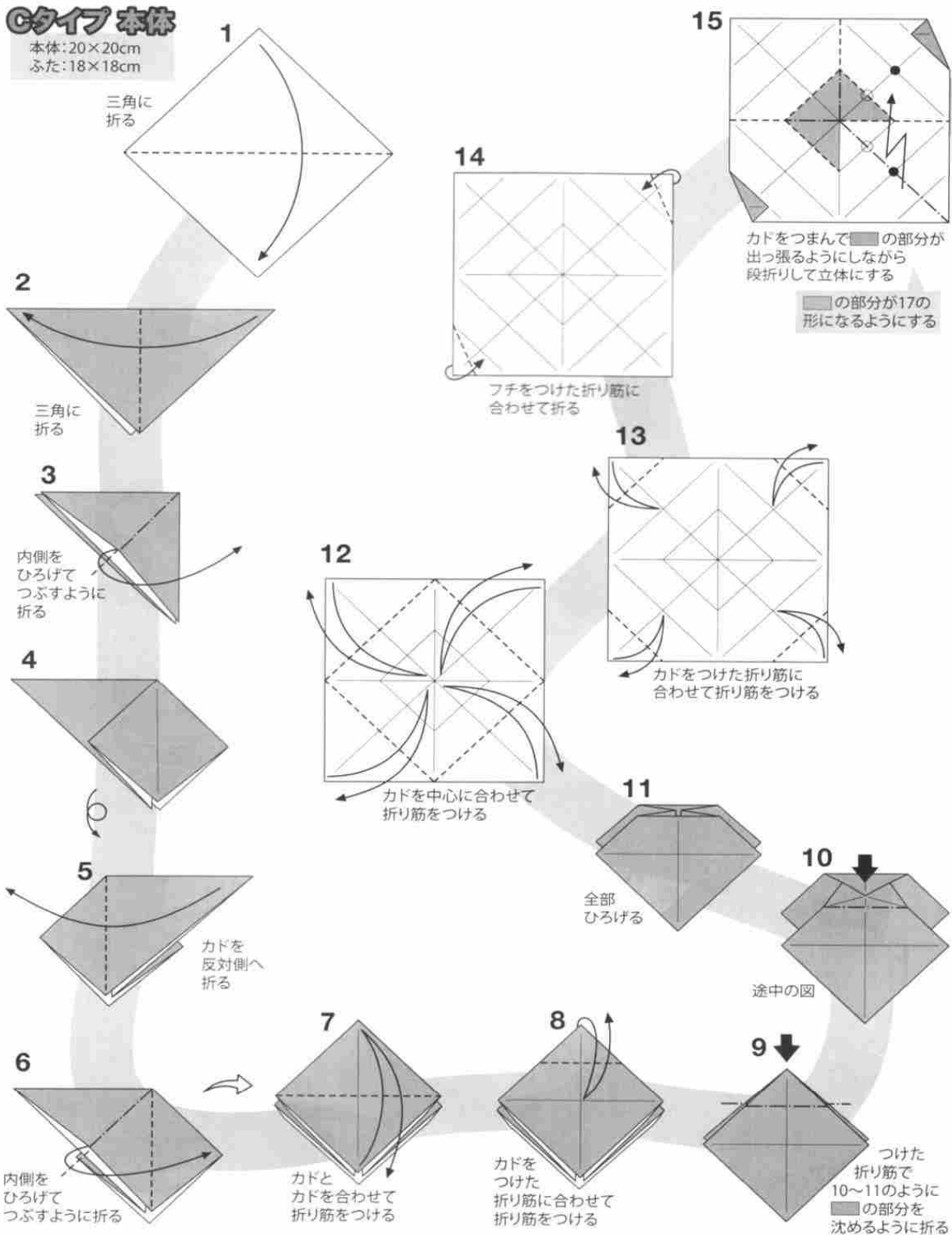

16

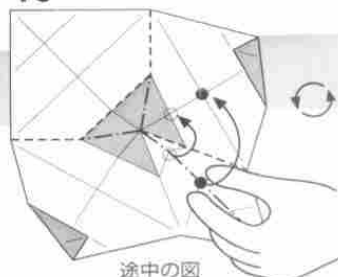

途中の図
○と○、●と●を
合わせて折る

17



中心が
図のような三角錐になる

18

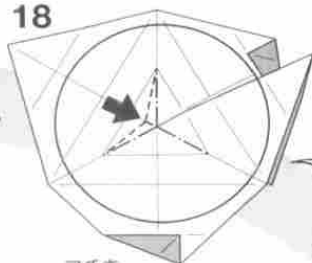

フチを
つまむようにして
中心が平らになるように
手前に折りたたむ

19



図のようにつまんで
折りたたむ

26

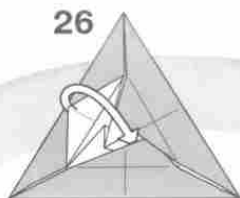

カドをすき間に
差し込む

27

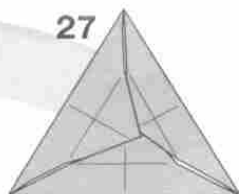

20

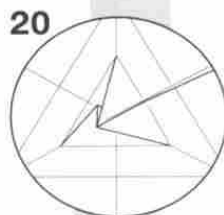

25

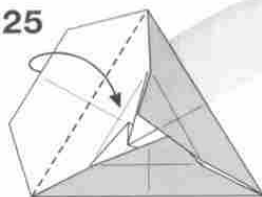

フチを内側に折る

28

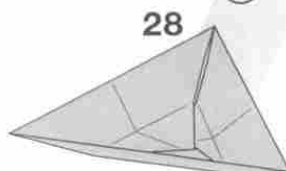

[Cタイプ本体]
できあがり

24

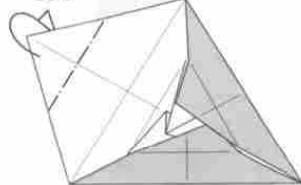

カドを後ろへ折る

21

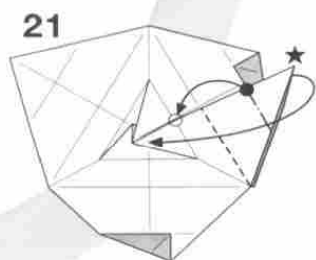

●と○を合わせて
★のカドを内側に
折る

23

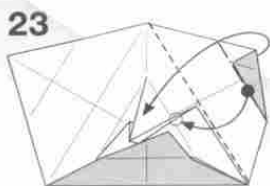

●と○を合わせて
カドを内側へ折る

22

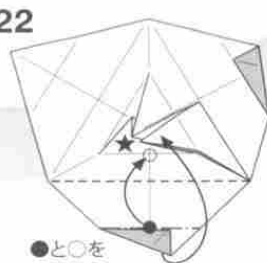

●と○を
合わせて
カドを内側に折る

ふた A~C共通

P.117
[Cタイプ本体]の
6まで折ってから
始める

1

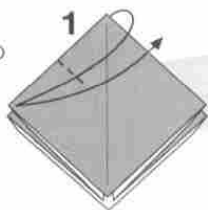

カドとカドを合わせて
折り筋をつける

2

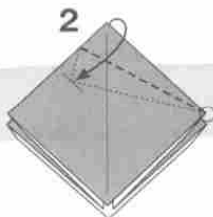

カドをつけた折り筋に
合わせて折る

3

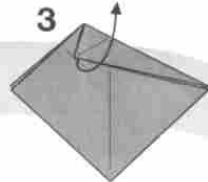

しっかりと折り筋を
つけてから戻す

4

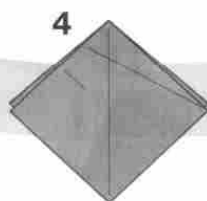

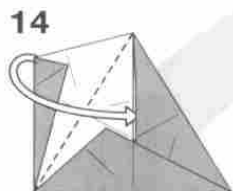

14
ついている折り筋で
すき間に差し込んで
とめる

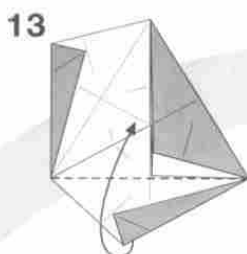

13
ついている
折り筋で折る

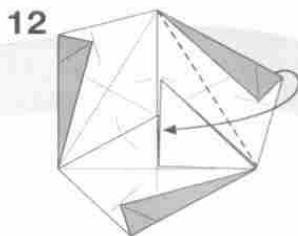

12
ついている
折り筋で折る

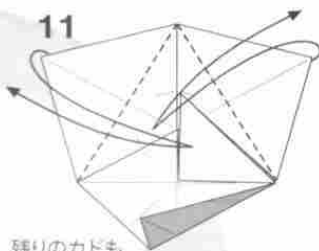

11
残りのカドも
8~10と同じように折る

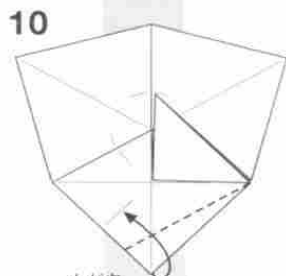

10
カドを
つけた折り筋に
合わせて折る

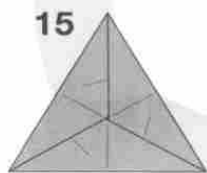

15



16

フチを起こして
形を整える

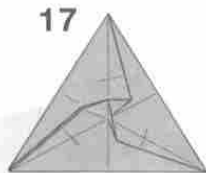

17
[ふた]できあがり

[A・Bタイプの紙の比率]



[A・Bタイプの]の[ふた]は
[本体]の3分の2の大きさ

[Cタイプの紙の比率]

[Cタイプの]の[ふた]は
[本体]よりも少し小さい
紙を使う

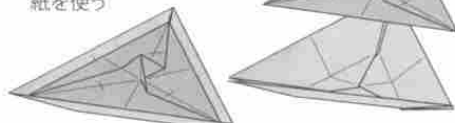

[本体]を15×15cmで折った場合は
[ふた]は13×13cmくらいが目安

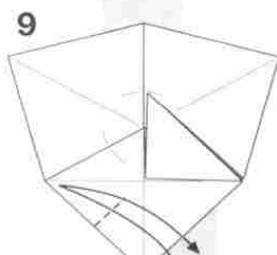

9
カドと
カドを合わせて
折り筋をつける

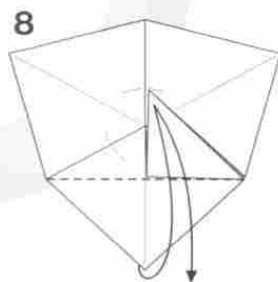

8
カドを結ぶ線で
折り筋をつける

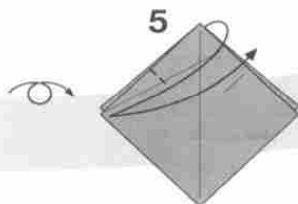

5
1~2と同じように
折る

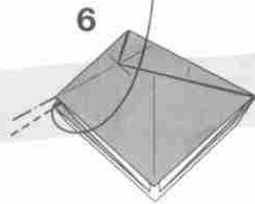

6
内側をひろげて
つぶすように折る
平らになる

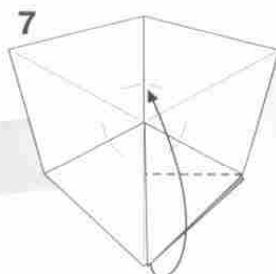

7
カドを折り筋に
合わせて折る

Iso-Area Flower

by Miyuki Kawamura : Japan

Diagram by Miyuki Kawamura

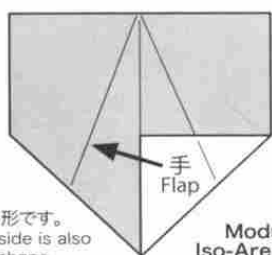
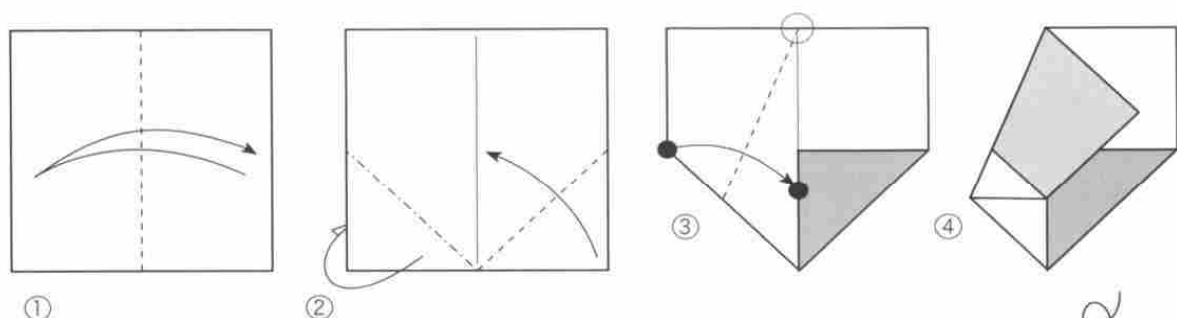

Module of Iso-Area Flower
表裏同等フラワーのユニット
同じものを 8 個作ります
We need 8 modules.

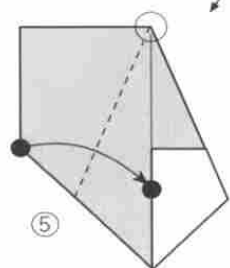
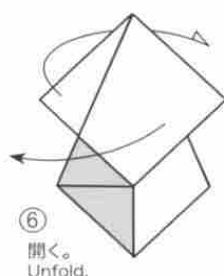

Assmblly / 組み方

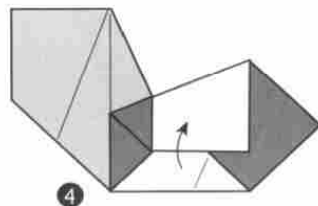
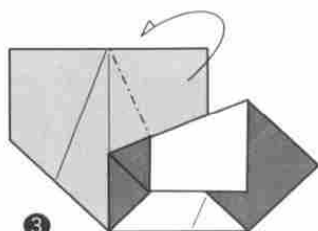
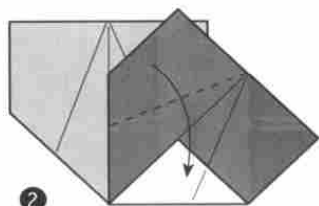
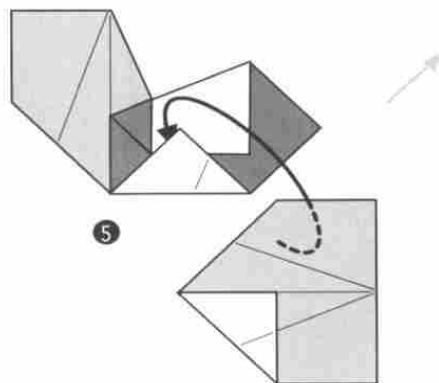
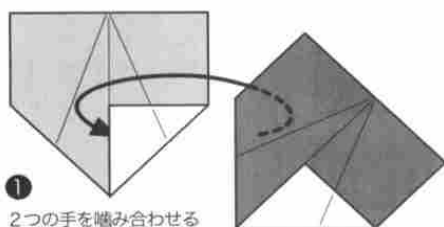

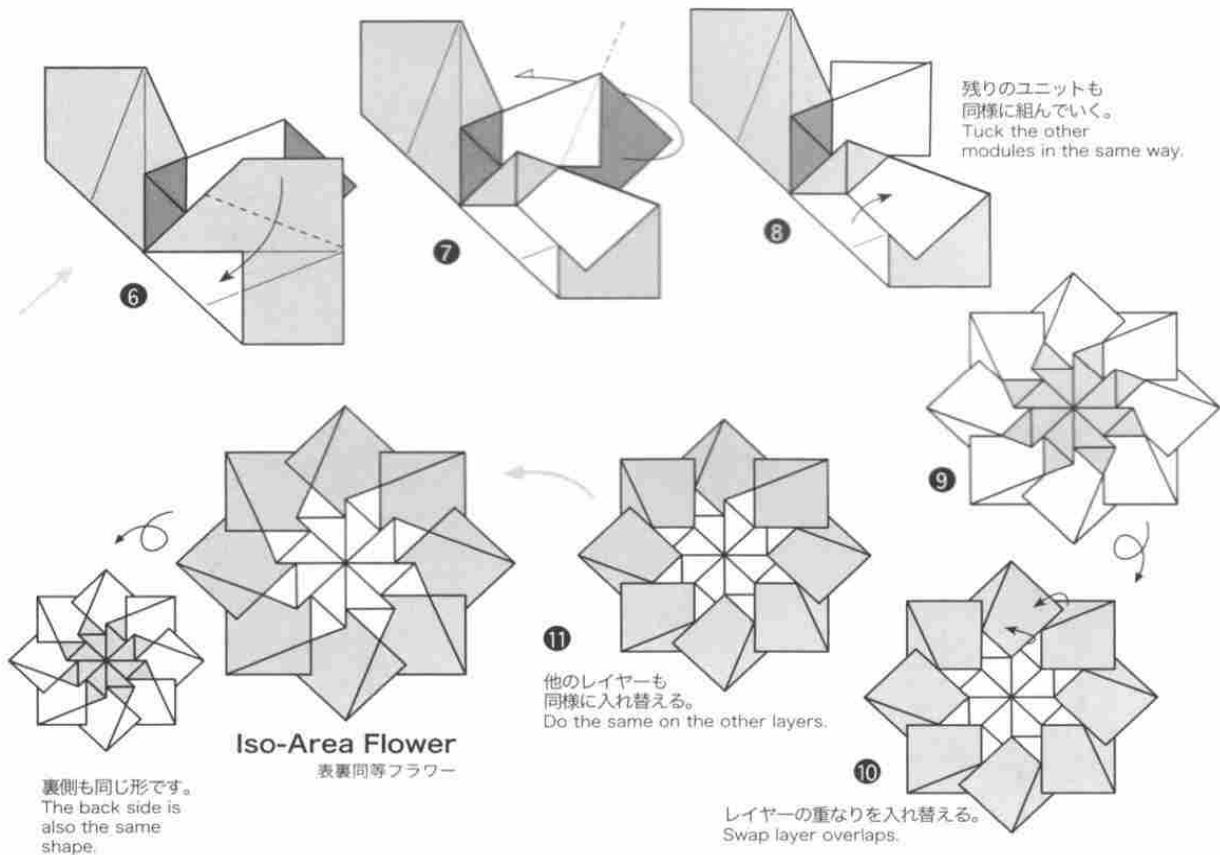

Iso-Area Star / 表裏同等スター

Variation 1 / バリエーション1

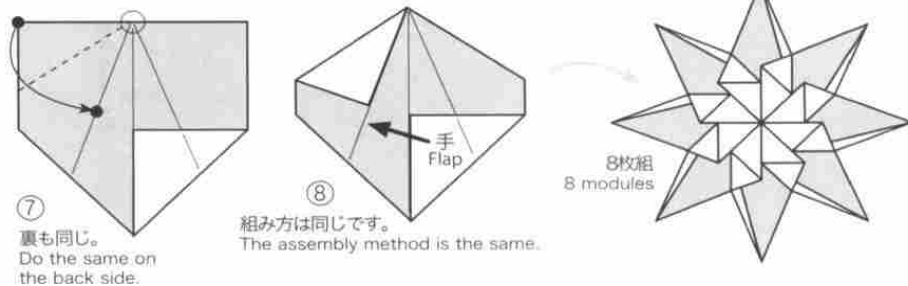

Variation 2 / バリエーション2

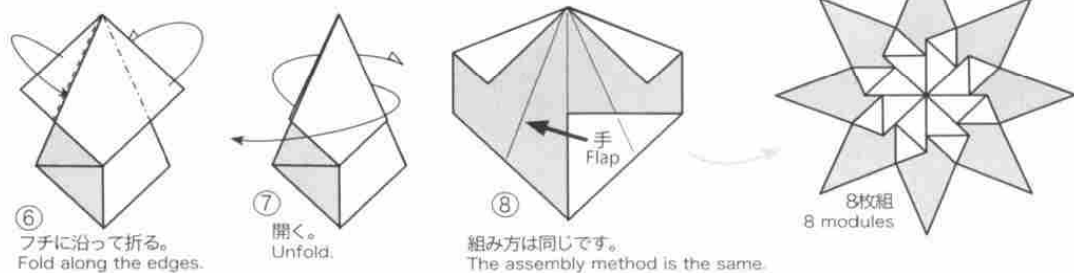

피젯스피너 Fidget Spinner

by Lim SeungBin : Korea

Diagram by Lim SeungBin

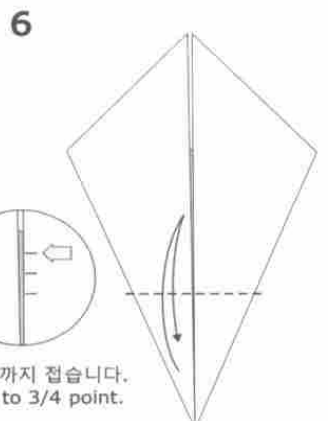
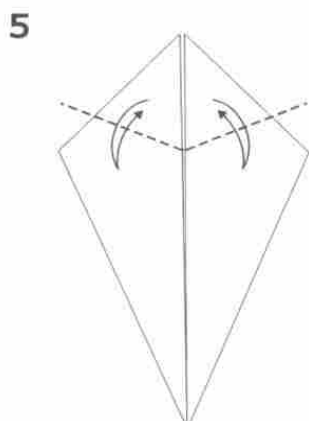
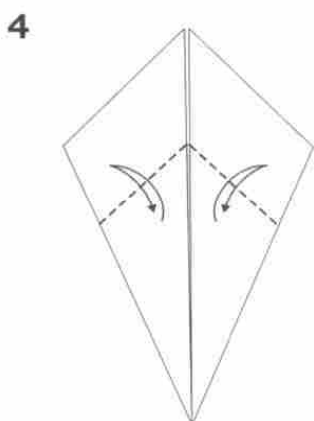
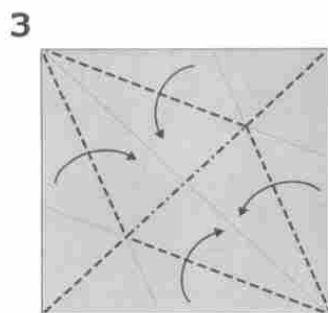
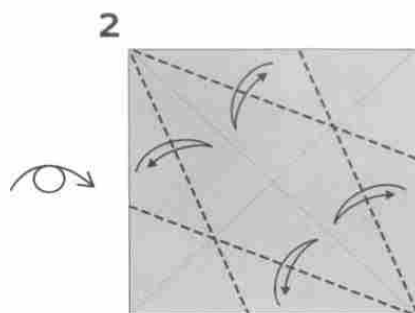
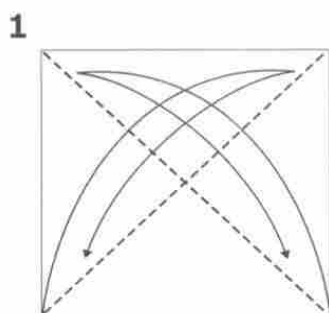
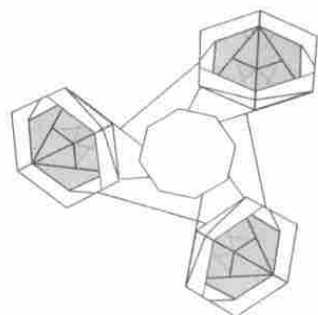

3/4 지점까지 접습니다.
Fold up to 3/4 point.

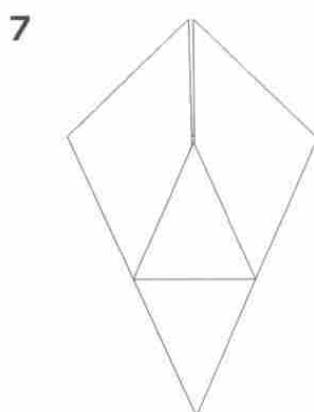

다시 펼칩니다.
Unfold.

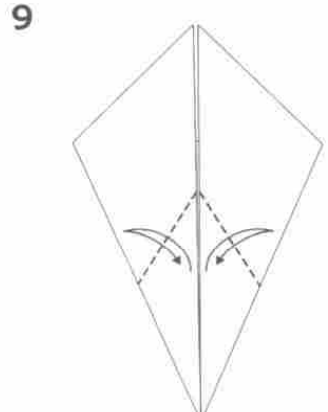
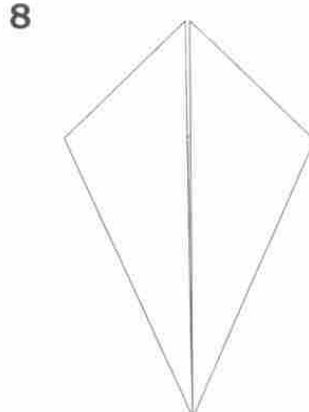

10

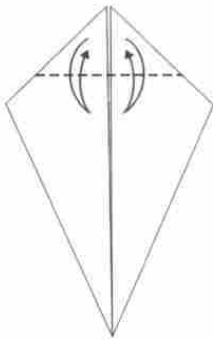

11

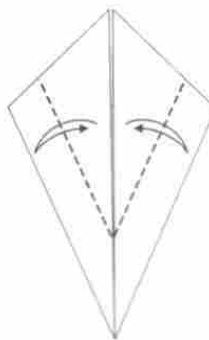

앞의 한 장만 접습니다.
Fold only the front flaps.

12

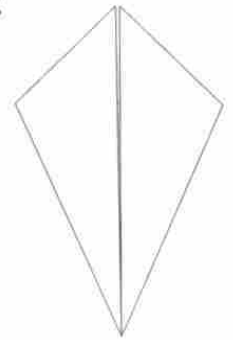

13

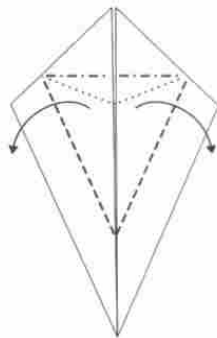

14

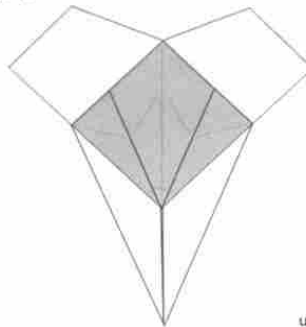

15

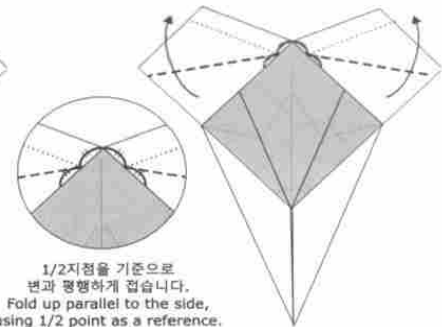

1/2지점을 기준으로
변과 평행하게 접습니다.
Fold up parallel to the side,
using 1/2 point as a reference.

16

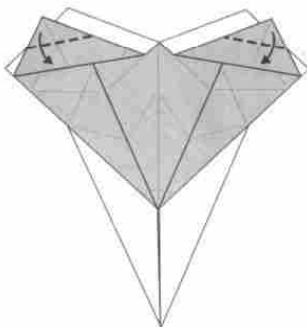

변과 평행하게 접습니다.
Fold down parallel to the side.

17

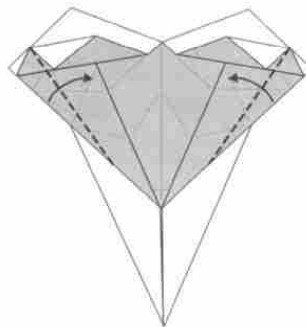

변과 평행하게 접습니다.
Fold sideways parallel to the side.

18

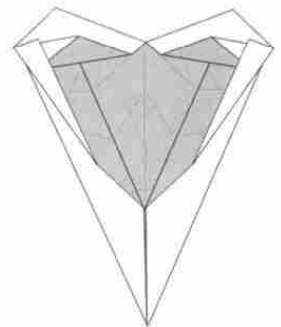

19

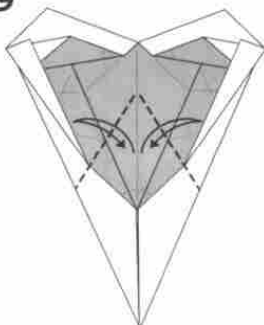

이미 존재하는 선을 다시 접습니다.
Re-crease the lines.

20

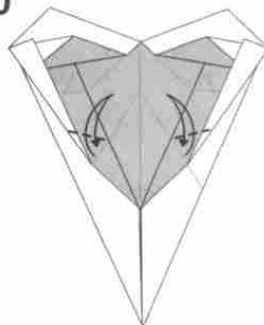

이미 존재하는 선을 다시 접습니다.
Re-crease the lines.

21

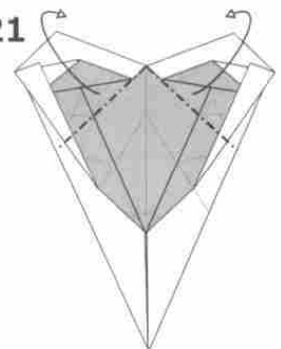

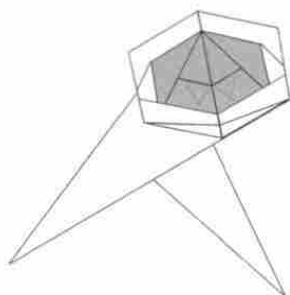
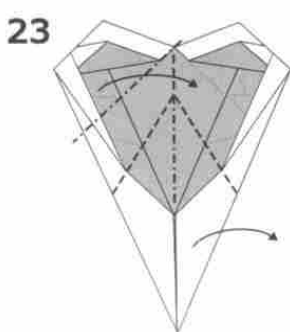
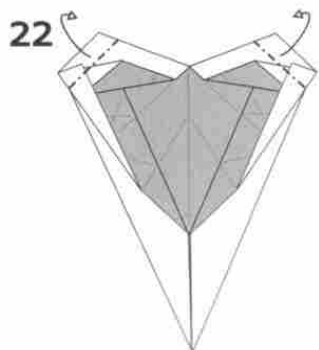

날개 파츠 완성
Wing parts Complete

X 3

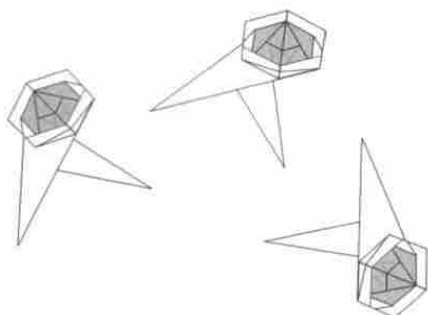

베어링 & 축
Bearing & Axis

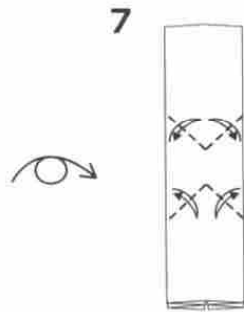
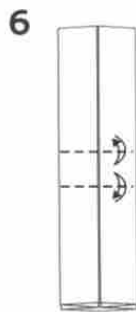
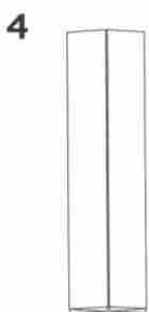
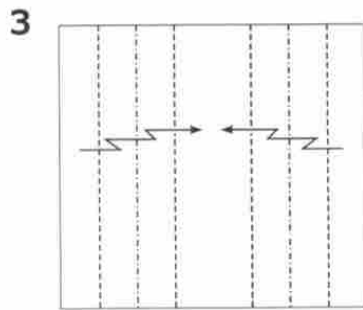
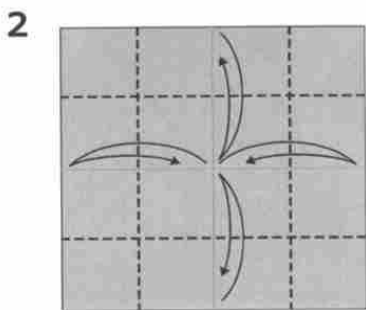
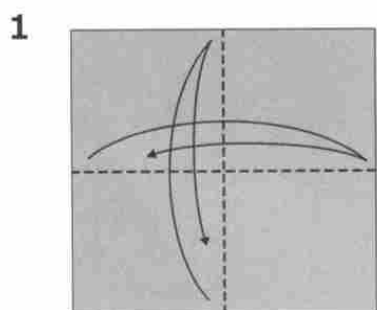

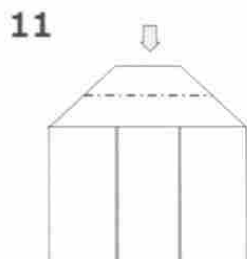
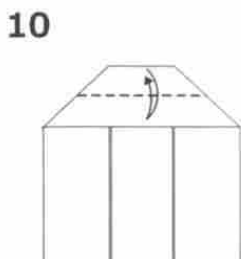
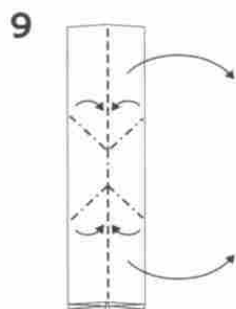

함몰접기합니다.
Open sink.

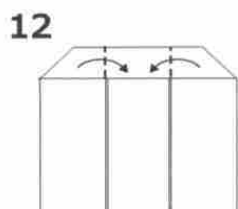

3D 형태로 접습니다.
Make it to 3D shape.

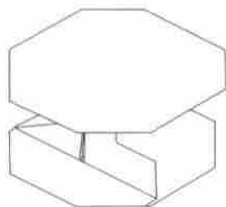
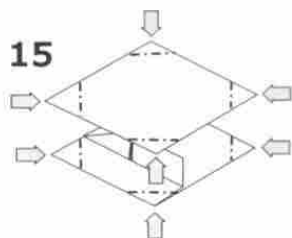
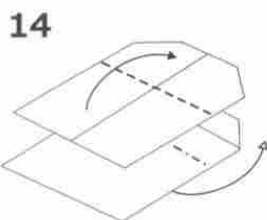
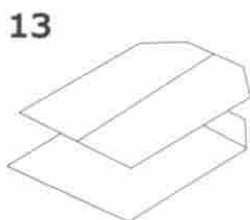

베어링 & 축 완성
Bearing & Axis Complete

결합 combination

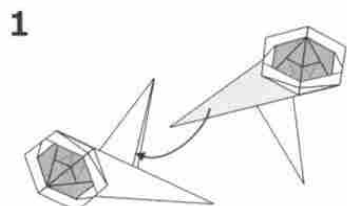

색칠한 부분을
주머니에 끼워 넣습니다.
Put colored side
into the pocket.

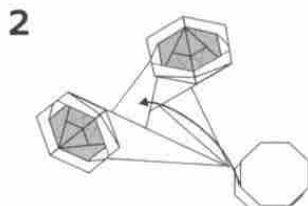

베어링을
두 개의 파트 사이에 끼웁니다.
Put bearing between
two connected wings.

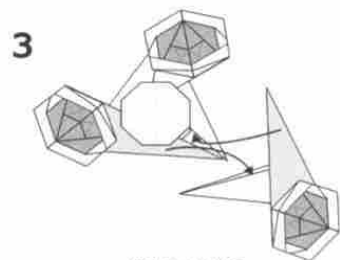

색칠한 부분을
화살표 방향대로 끼워 넣습니다.
두 부분을 동시에 진행하기에
가다릅니다.
Put colored sides into
each one's pockets.

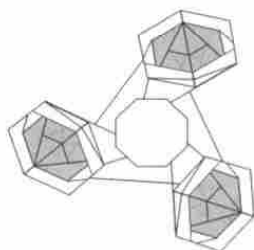

완성
Model Complete

Peace and Love

by Xiaoxian HUANG : China

Diagram by Xiaoxian HUANG

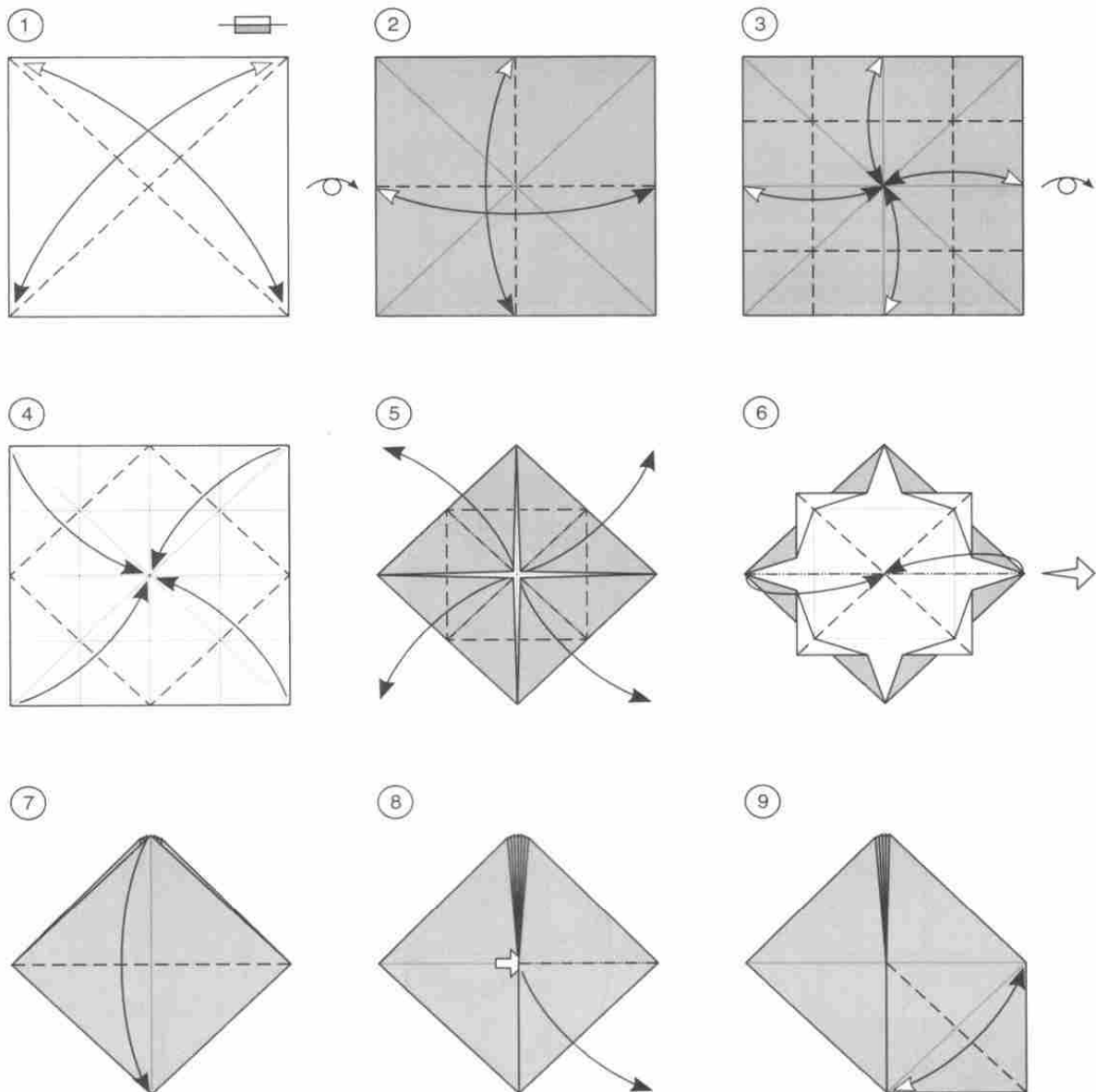
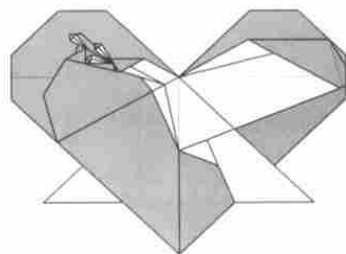

10

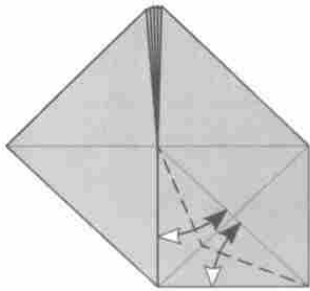

11

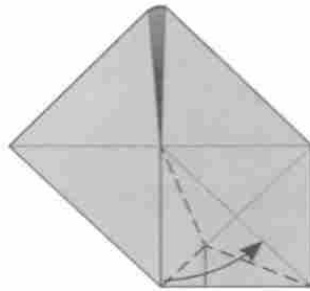

12

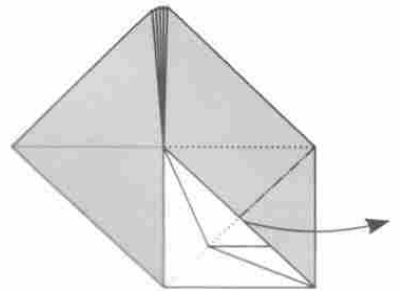

13

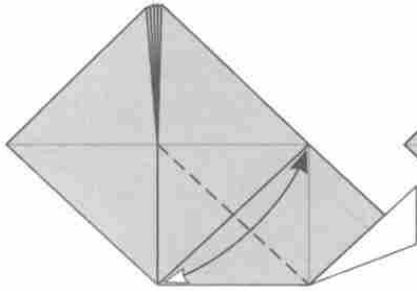

14

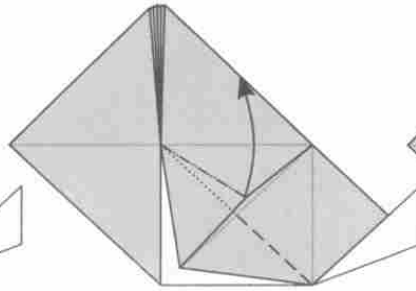

15

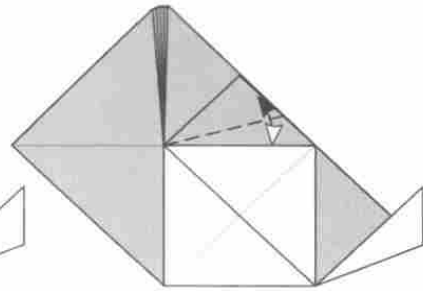

16

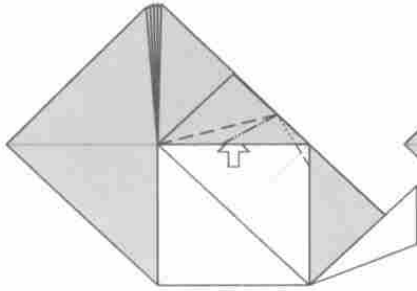

17

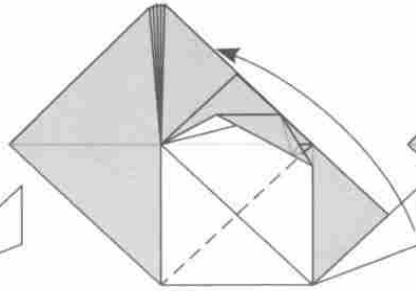

18

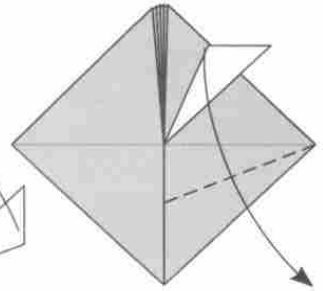

19

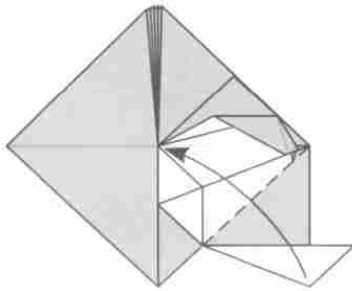

20

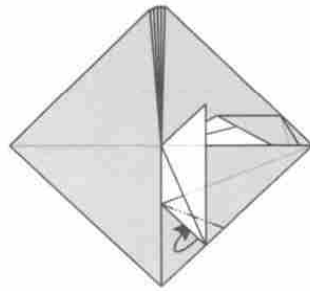

21

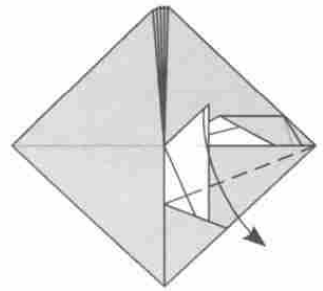

22

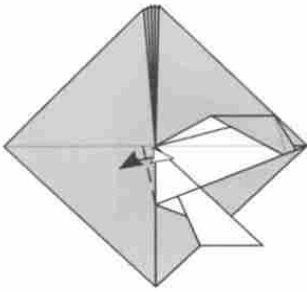

23

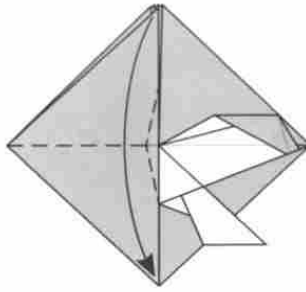

24

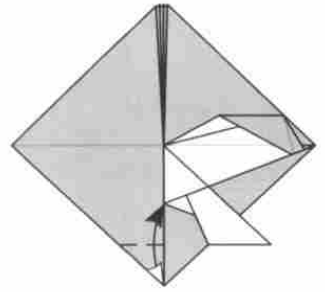

25

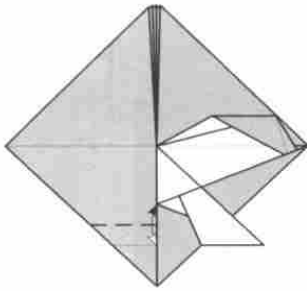

26

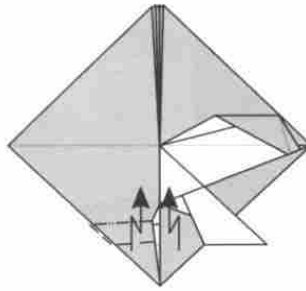

27

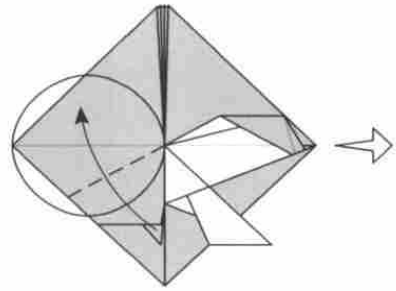

28

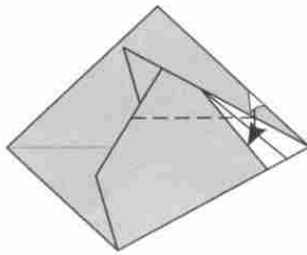

29

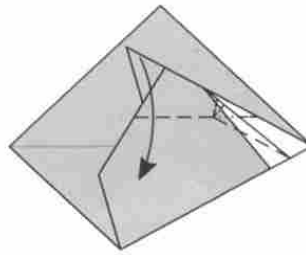

30

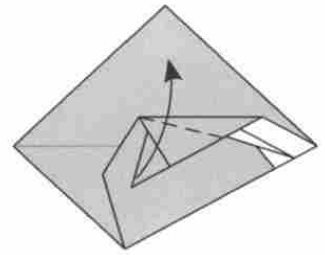

31

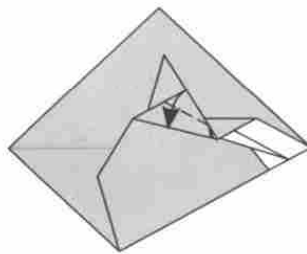

32

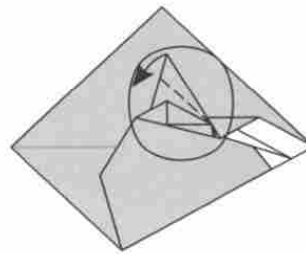

33

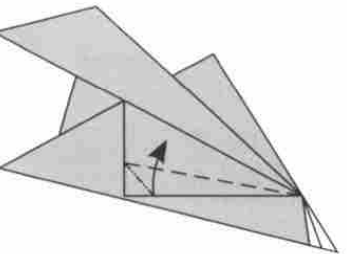

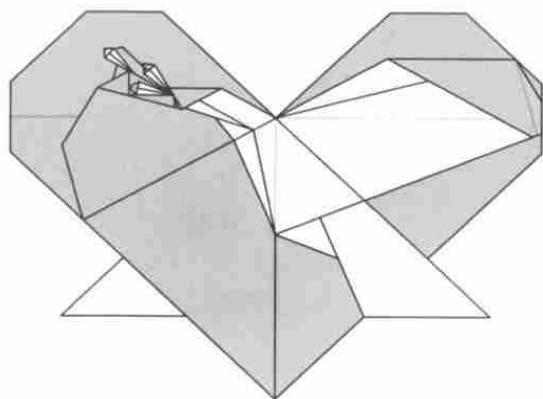
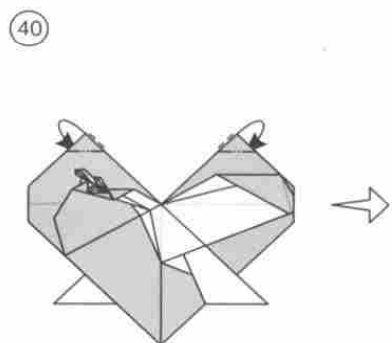
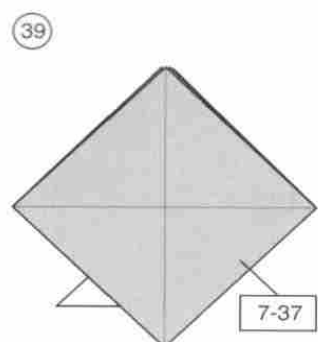
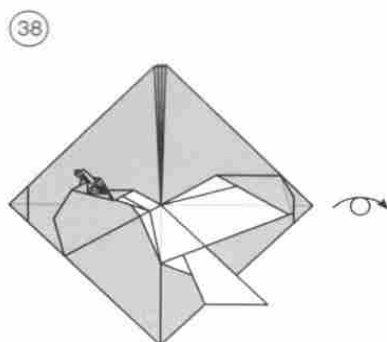
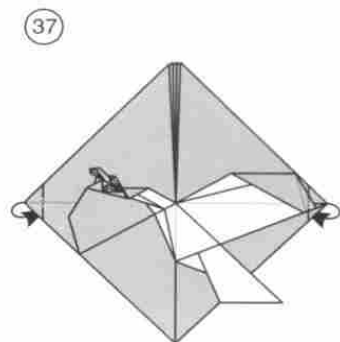
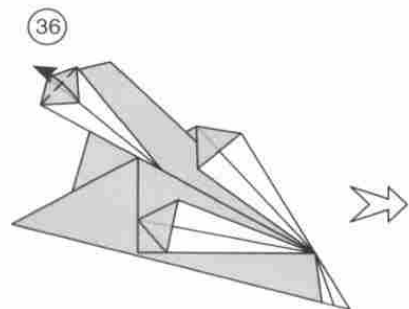
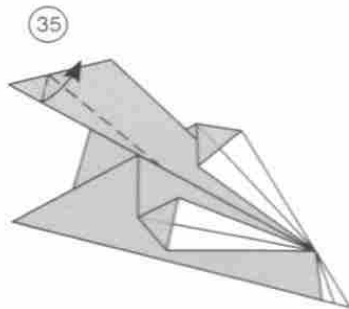
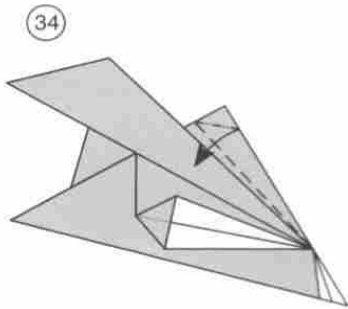

퍼즐 Puzzle

by Usman Rosyidhi : Indonesia

Diagram by Usman Rosyidhi

①

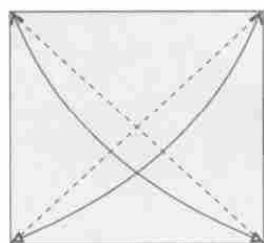

②

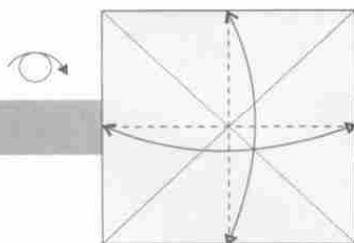

③

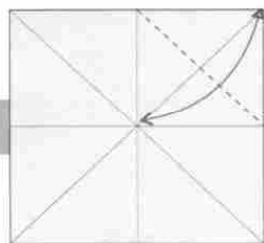

⑥

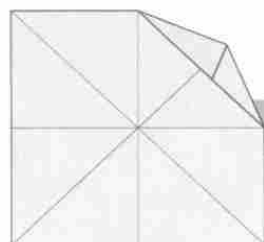

⑤

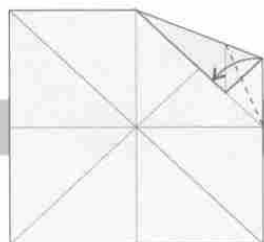

④

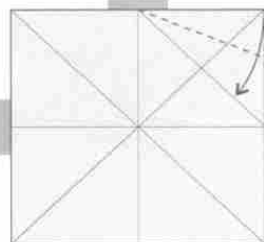

⑦

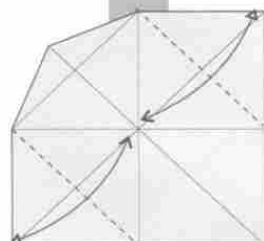

⑧

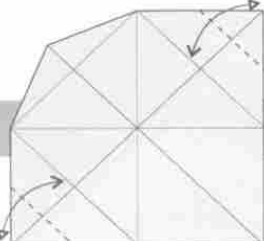

⑨

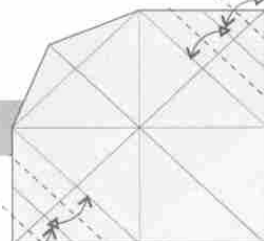

⑫

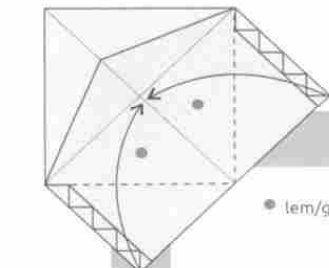

⑪

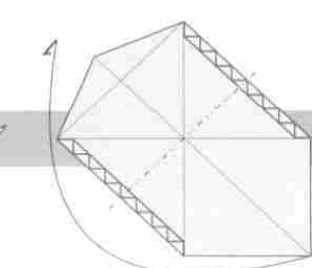

⑩

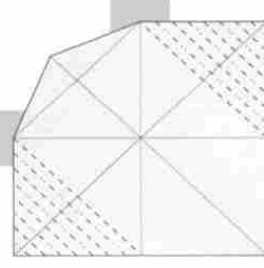

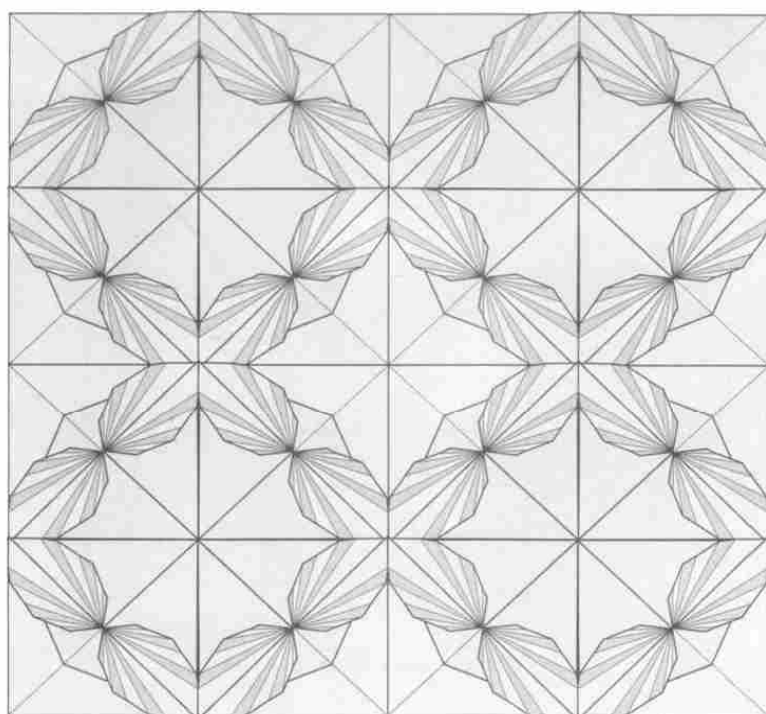

13



F-22 랩터

F-22 Raptor

by Kim Jooil : Korea
Diagram by Kim Jooil

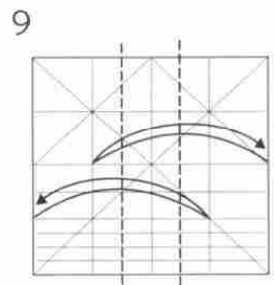
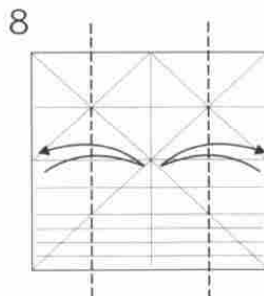
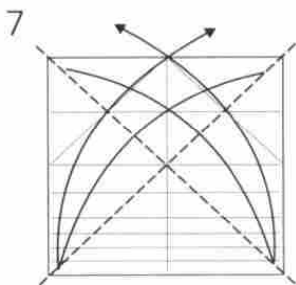
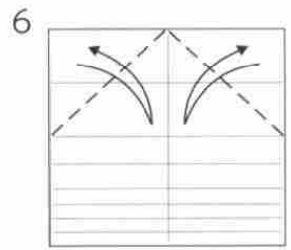
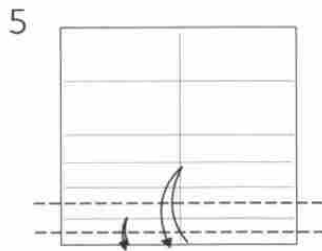
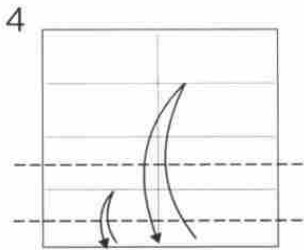
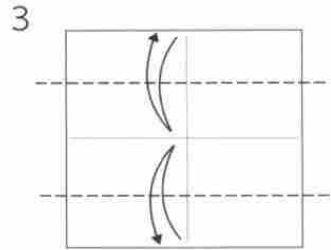
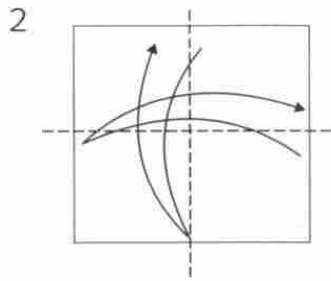
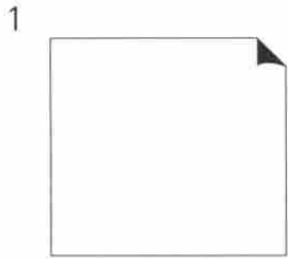
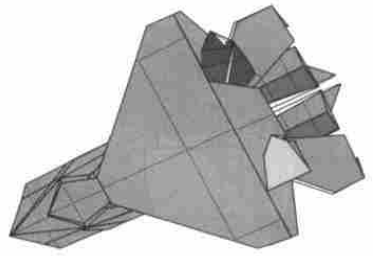

10

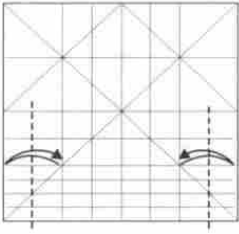

11

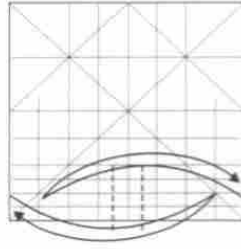

12

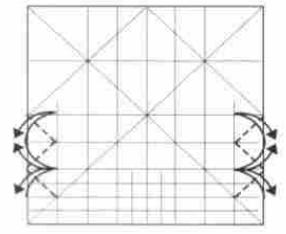

13

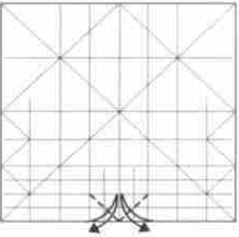

14

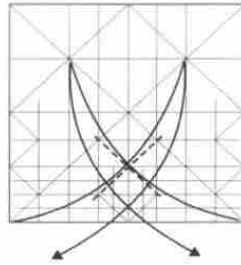

15

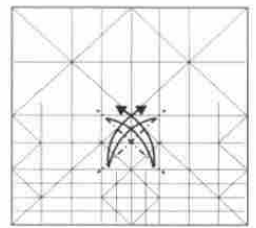

16

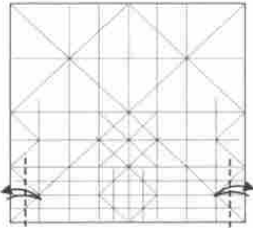

17

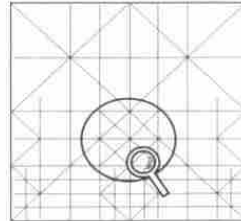

동그라미 부분을 봐주세요.

18

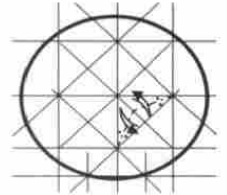

19

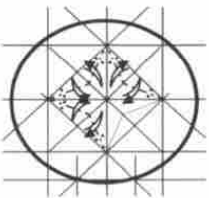

20

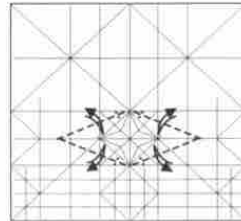

21

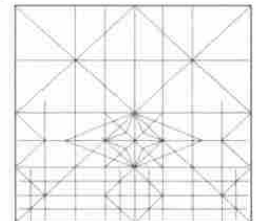

22

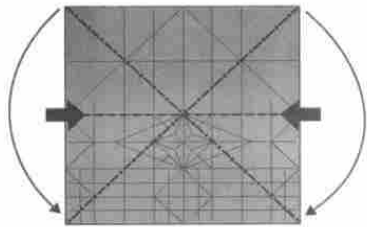

삼각주머니 기본형을
만들어주세요.

23

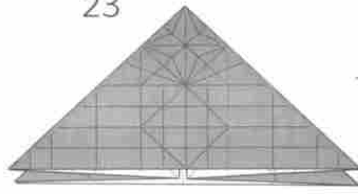

24

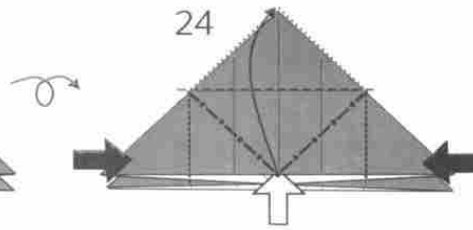

25

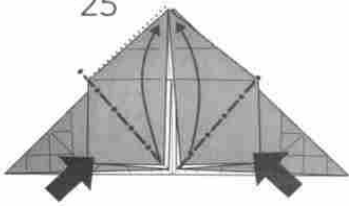

26

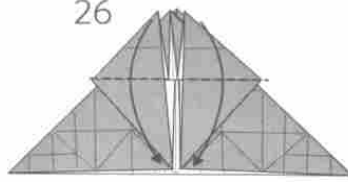

27

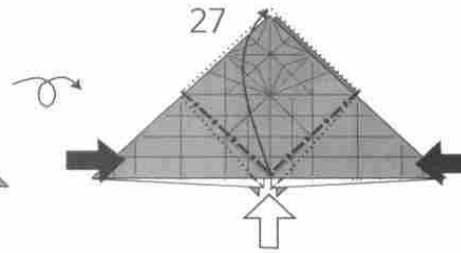

28

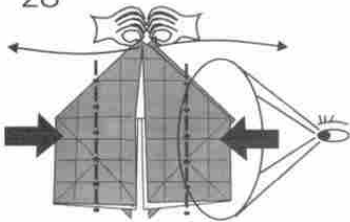

함몰접기를 해주세요.
기호처럼 손으로 잡아 벌려서
옆으로 봐주세요.

29

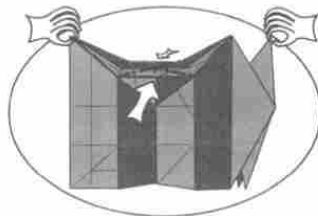

30

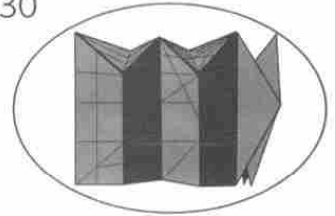

31

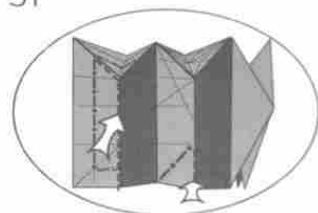

해당 산골선을 접어주고
반대쪽을 봐주세요.

32

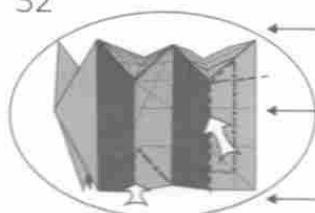

해당 산골선을 접어주고
33번 그림이 정면이 되게
돌려주세요.

33

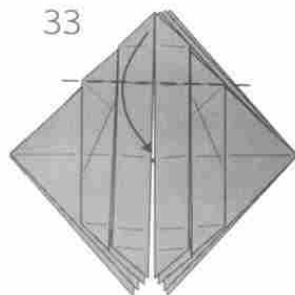

34

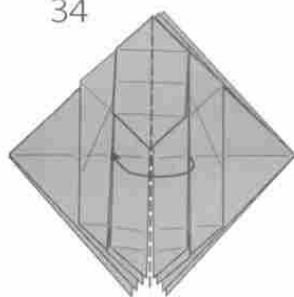

35

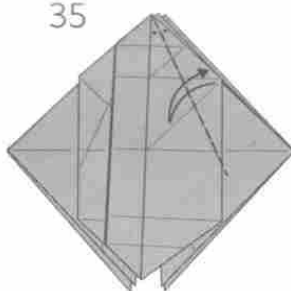

36

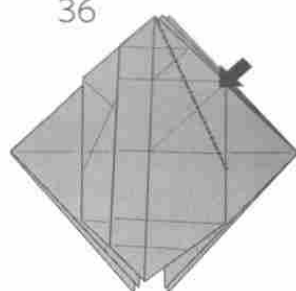

함몰집기 해주세요.

37

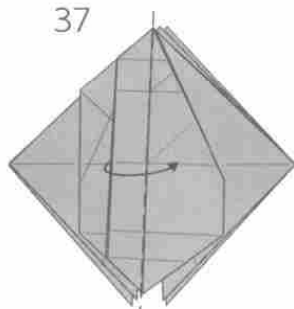

38

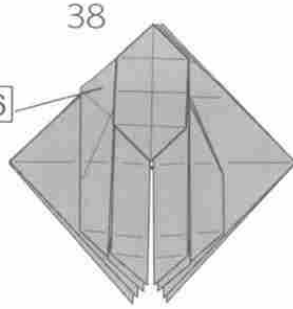

35-36

35-36번을 반복해주세요.

39

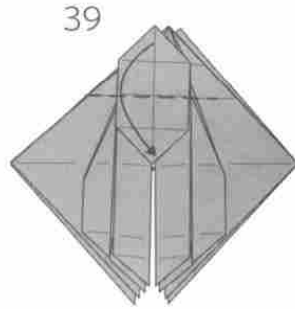

40

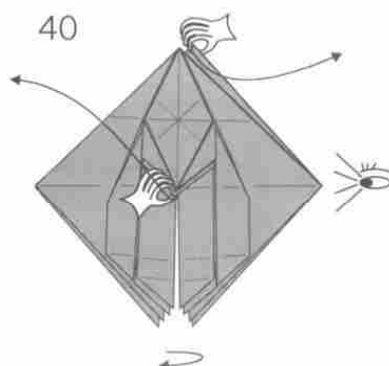

기호처럼 손으로 잡아 벌려서
옆으로 봐주세요.

41

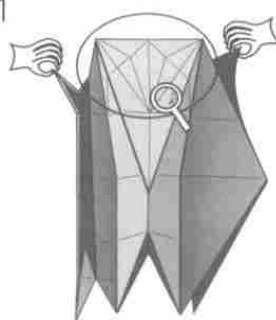

동그라미 부분을 봐주세요.

42

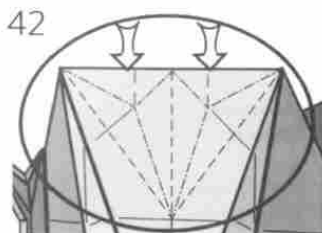

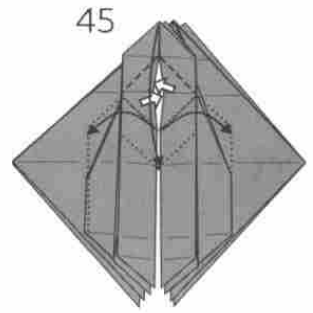
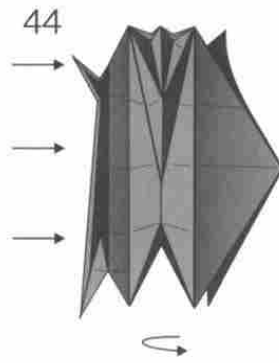
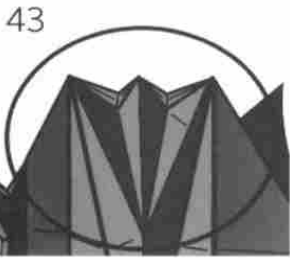

45번 그림이 정면이 되게
돌려주세요.

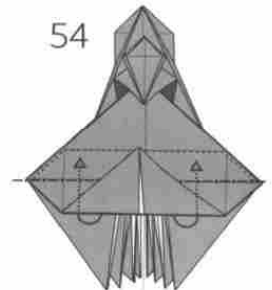
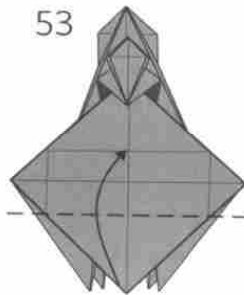
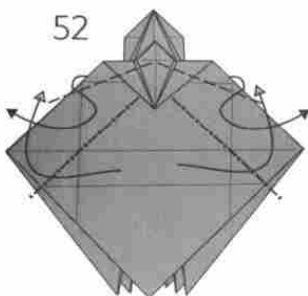
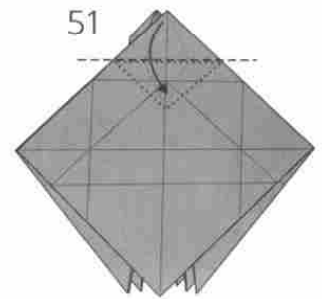
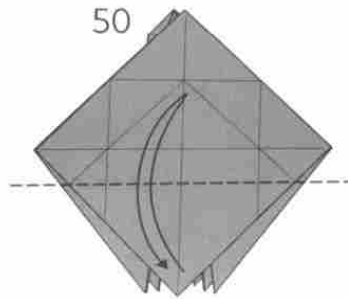
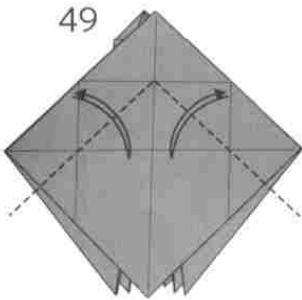
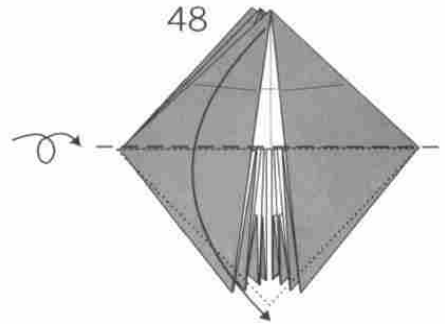
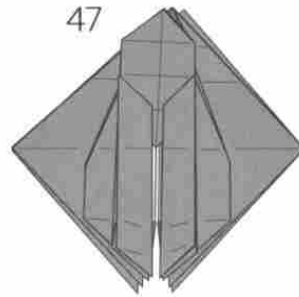
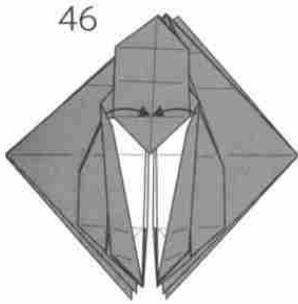

안쪽으로 집어 넣어 주세요.

55

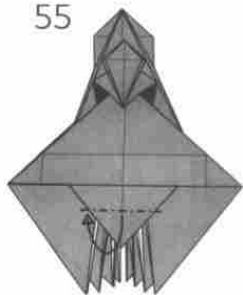

56

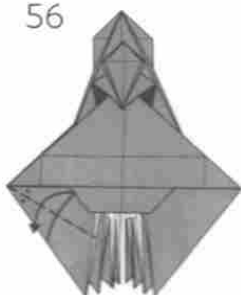

57

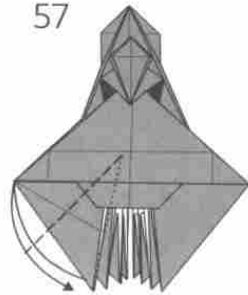

58

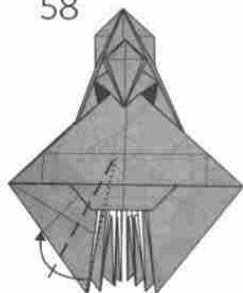

59

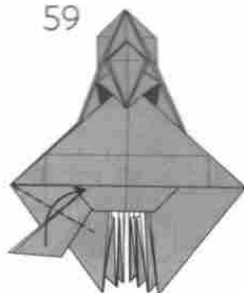

60

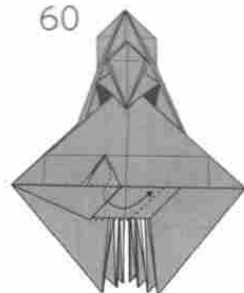

61

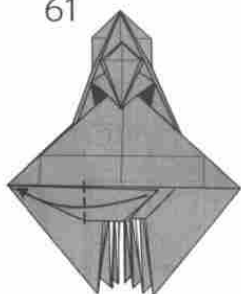

62

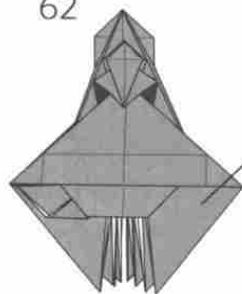

56-61

63

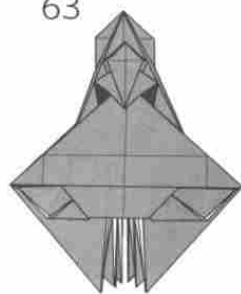

56-61번을 반복해주세요.

64

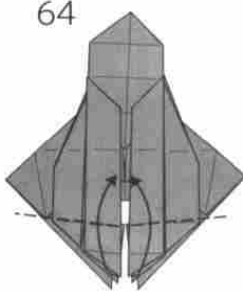

65

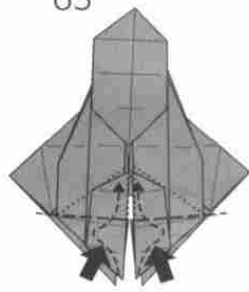

안쪽으로 집어 넣어 주세요.

66

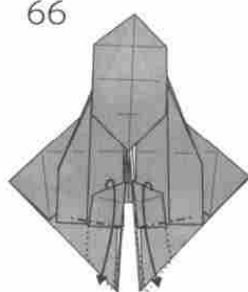

67

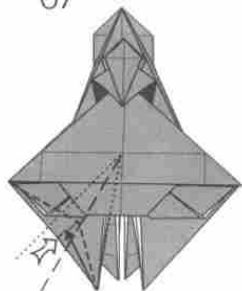

선대로 밀어 넣어
접으세요.

68

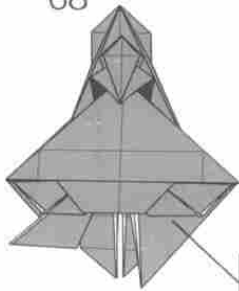

67번과 같은 방법으로
접으세요.

69

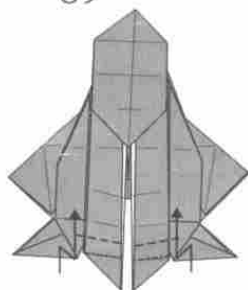

계단접기를 해주세요.

70

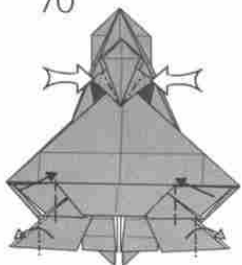

71

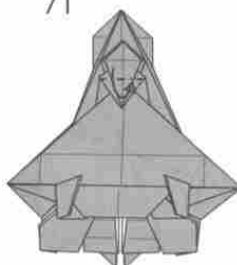

72

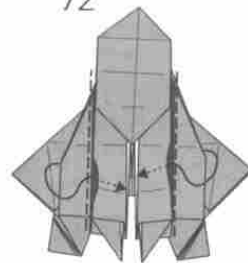

안쪽 레이어로 접어
넓어 주세요.

73

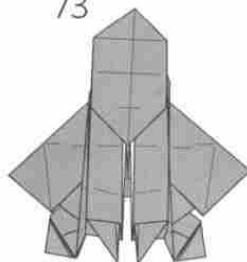

74

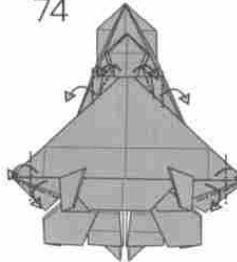

75

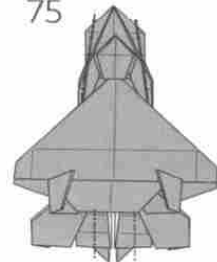

표시 부분을 조금씩
안쪽으로 다듬기
해주세요.

76

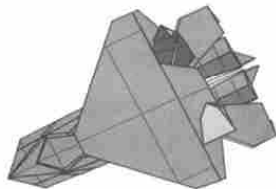
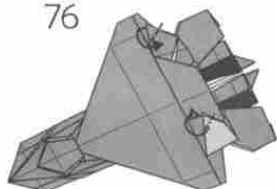

완성

우유 Milk

by Lee SeungHo : Korea

Diagram by Lee SeungHo

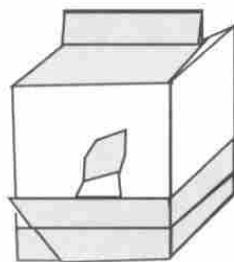

1

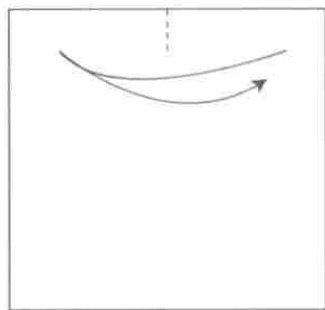

2

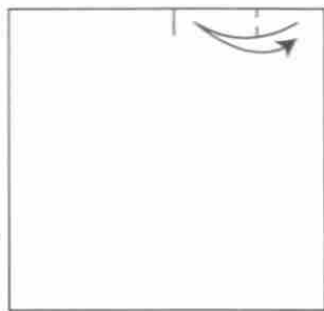

3

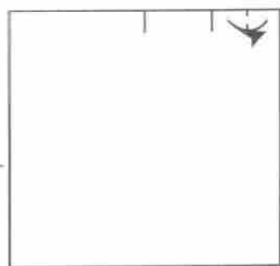

4

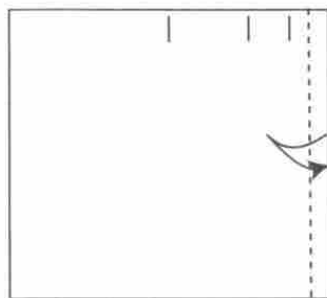

5

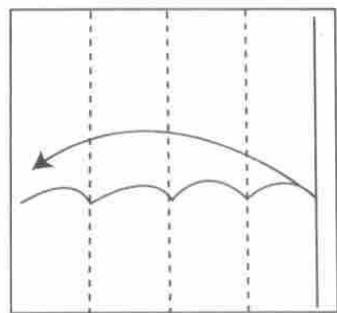

6

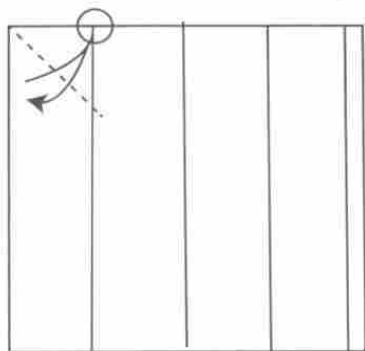

7

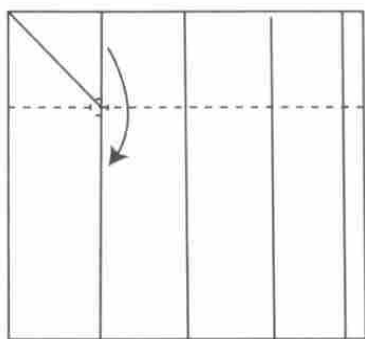

12

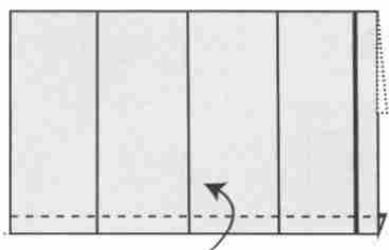

13

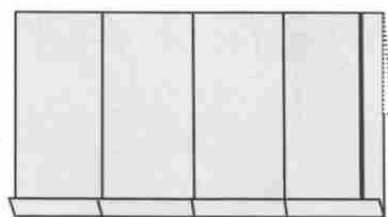

11

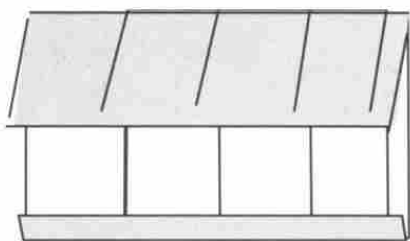
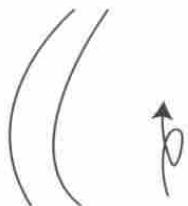

10

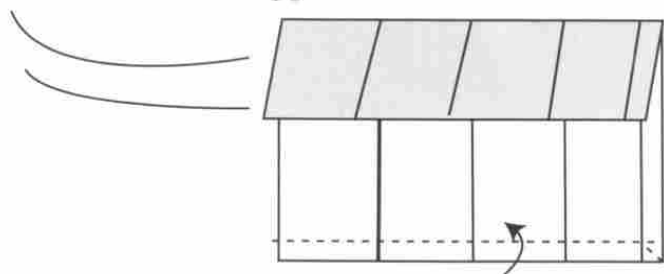

9

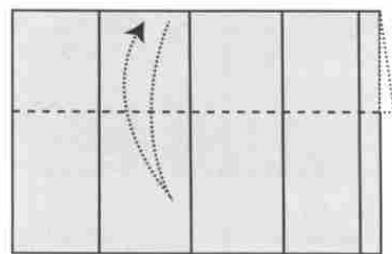

8

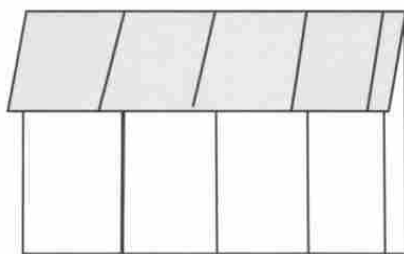
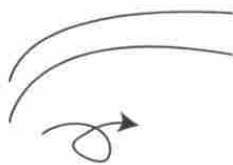

14

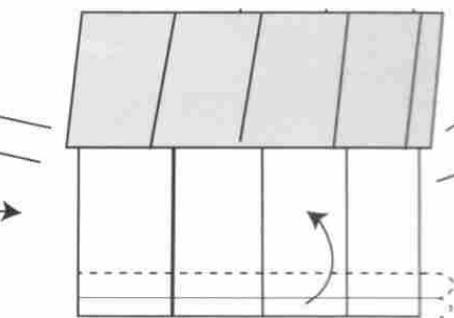

15

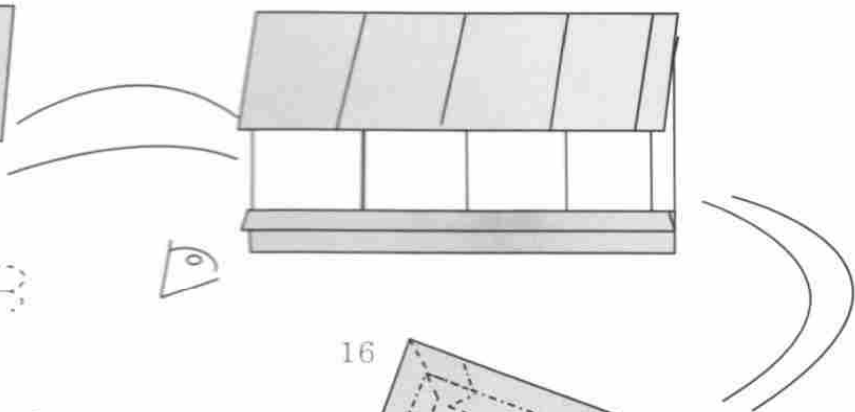

17

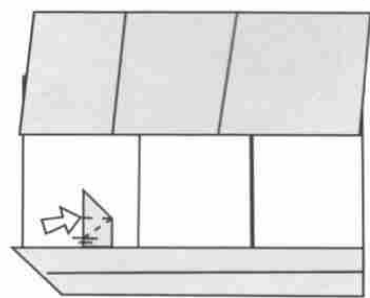

펼쳐 눌러 접습니다.

16

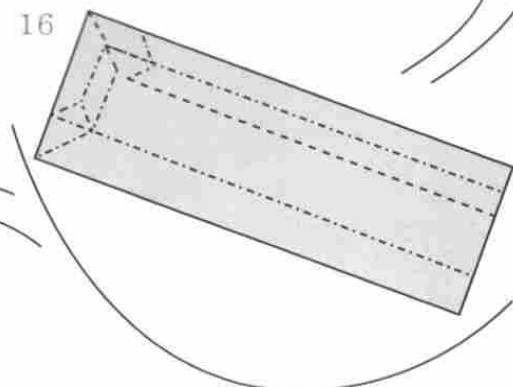

선대로 접습니다.

18

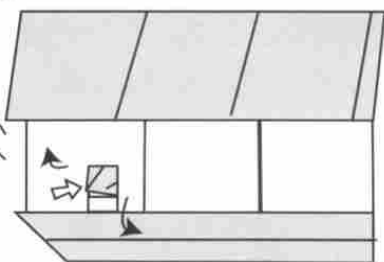

펼쳐 눌러 접습니다.
뒤집으세요.

19

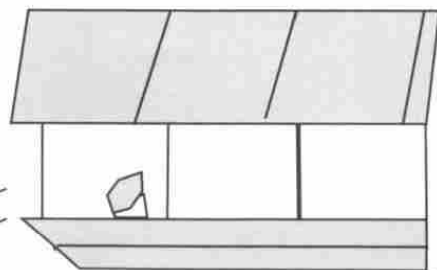

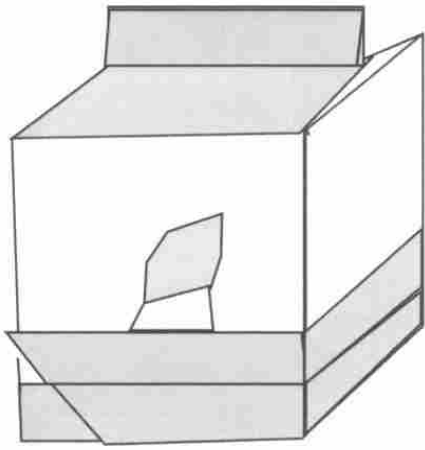

완성

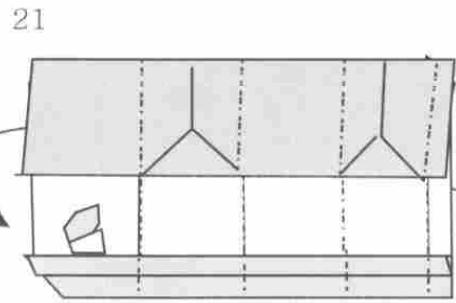
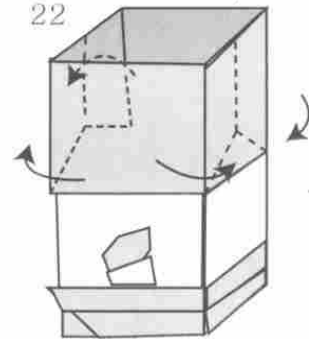
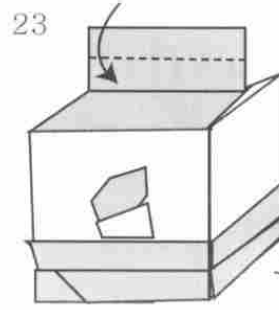

둥글게 말듯이 접어줍니다.

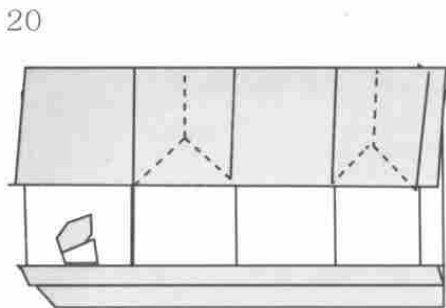

20

21

22

23