

おりがみ工房

おりがみ

布施 知子 著

包みと結び

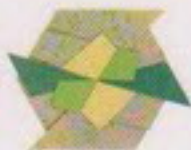

藤沢市総合市民図書館



000916045-8

四角包み・差し入れ

A4判 (210×297mm) あるいは
B4判 (257×364mm) が基準

ひとつ段折りしてひだを作り、そこに端を
差し入れてとめます。
B4判で折るとちょうどお札が入ります。



①



図のような折り線をつける

②

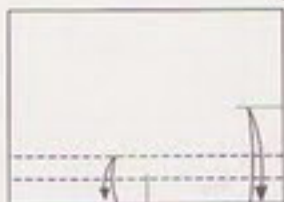

③



段に折る

④

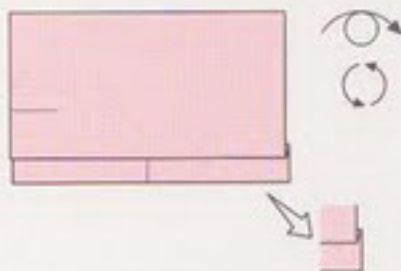

⑤



お札など包むものを入れる
(点線)

⑥

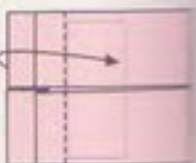

包むもののへりで折る

⑦

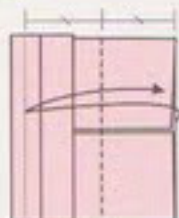

内側の重なった所に
合わせて折る

⑧



角を好みの分量で
少し折る

⑨

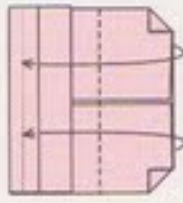

間にはさんでとめる

⑩



(裏)



四角包み・巻きどめ

紙の寸法 (210×297mm) あるいは
紙の寸法 (257×364mm) が基準

長方形や正方形で折ることができます。
手順⑦、⑧がポイント。



▶ 長方形から ▶

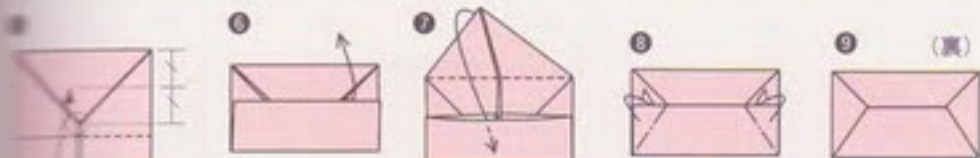
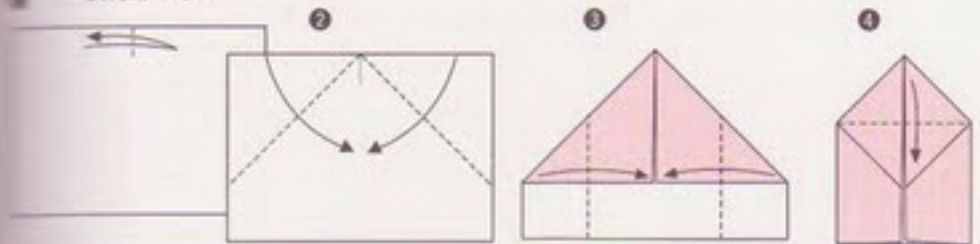

いったん開く

裏に入れる

巻いて折る

⑤を少し開けて
⑥の寸法で折る

⑦の折り幅でいろいろできる

▶ 正方形から ▶

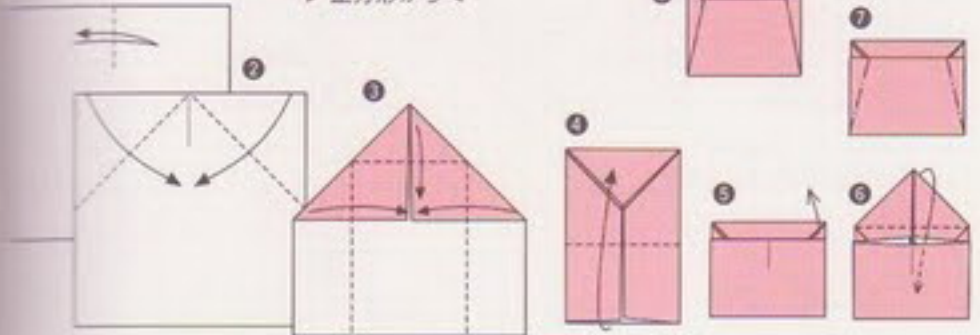

四角包み・斜交い

A4判 (210×297mm) あるいは
B4判 (257×364mm) が基準

辺の比が $1:\sqrt{2}$ ならではの折り方です。
はさんでとめると、裏面に斜交いの線
が出ます。



① 図のような折り線をつける

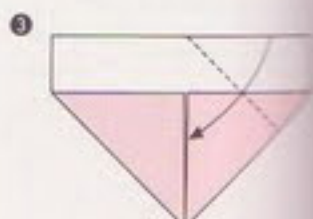
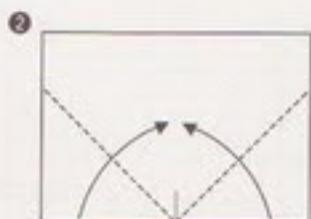

③ 辺に合わせて折る

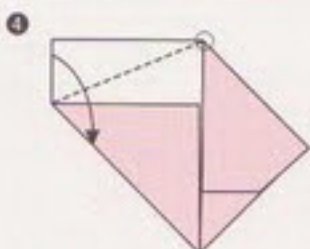

④ ヘリを合わせて折る

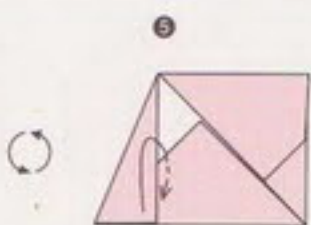

⑤ 間に入れる

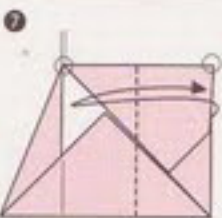
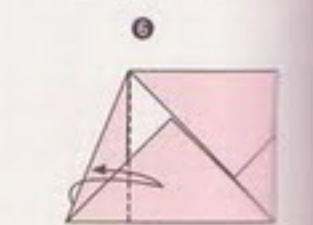

⑦ 厚みを考慮して、○印より
1mmほど手前に合わせて折る。

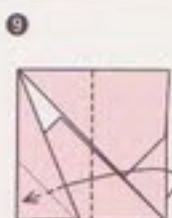
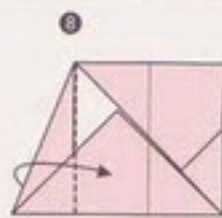

⑨ はさんでとめる



四角包み・斜交い帯／のし

①4折 (210×297mm) あるいは
②4折 (257×364mm) が基準



▶折り帯◀

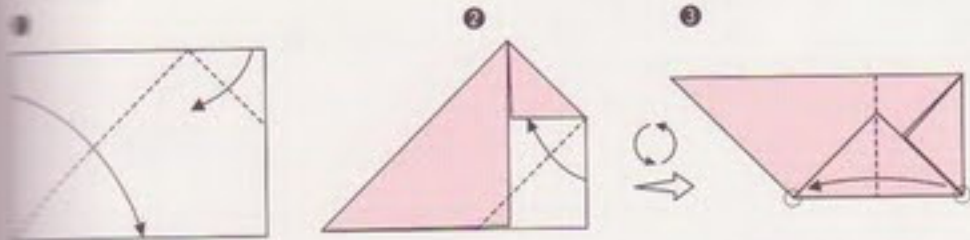

合わせて折る

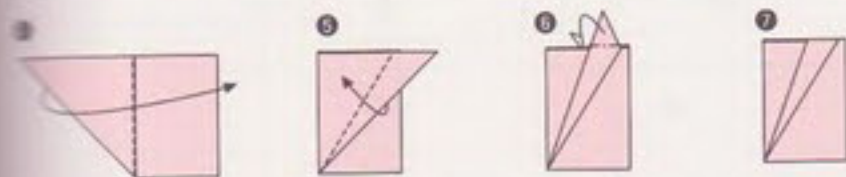

適当な幅で折る

はさんでとめる

▶のし◀

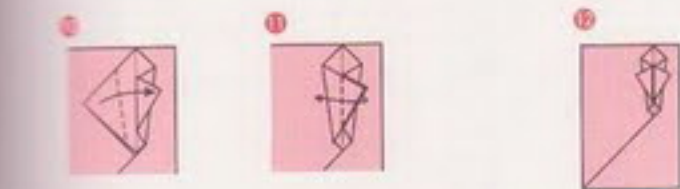
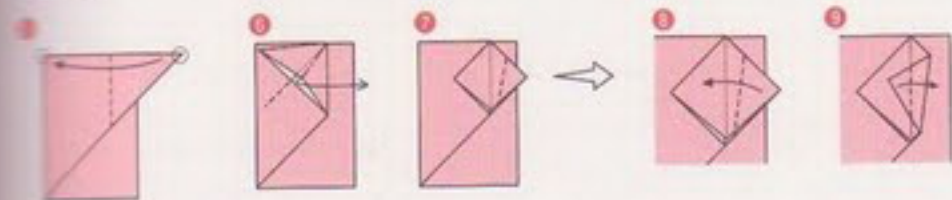

封筒折り 1

A4判 (210×297mm) あるいは
B4判 (257×364mm) が基準

手順①の折り幅で縦横の比率が違っ
てきます。お好みでどうぞ。

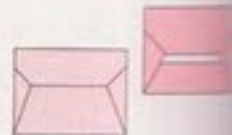

▶ 基本 ◀

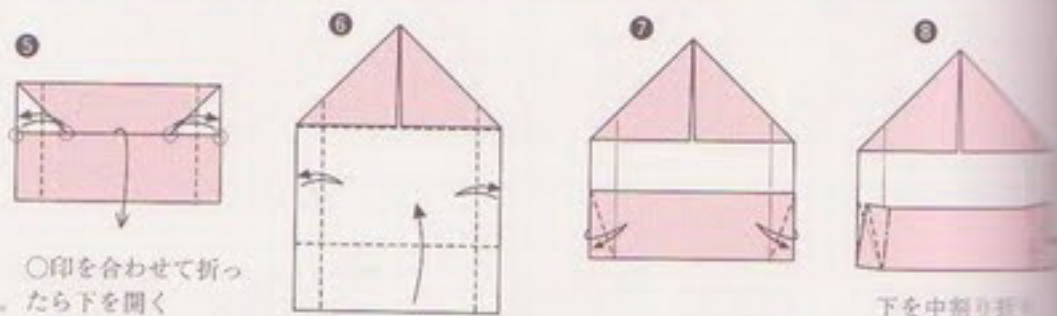
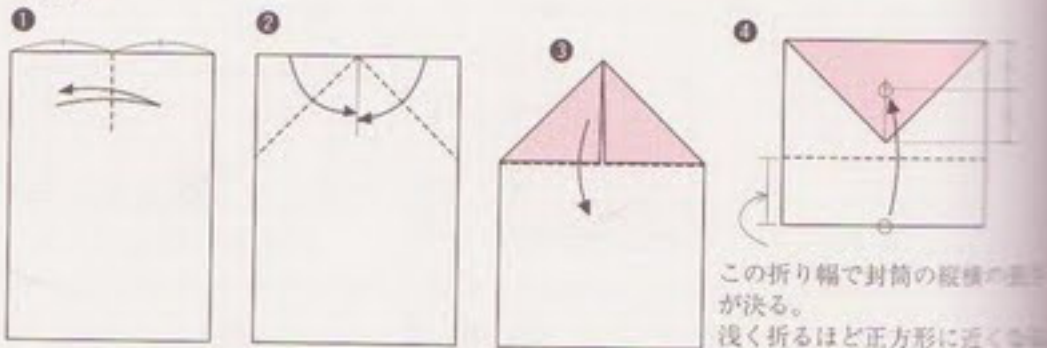

○印を合わせて折っ
たら下を開く

下を中割り折り

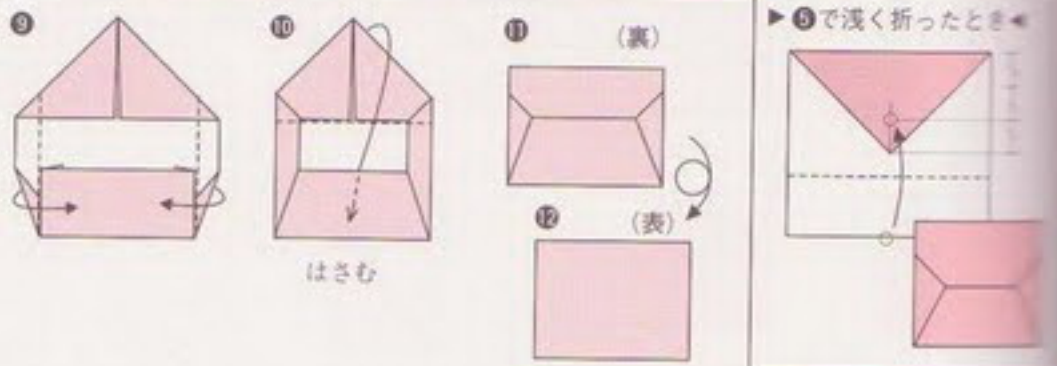

※送り表◀

②の①の下を適当な幅で折って
送り表にします。

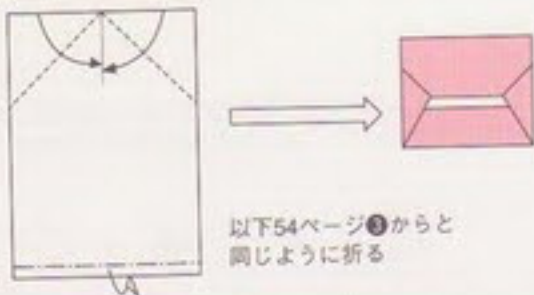

以下54ページ③からと
同じように折る

封筒折り 2

カードを包む：15cm×15cm)
封筒にする：(25cm×25cm)

30°の折り線を使うとすっきり
仕上がります。

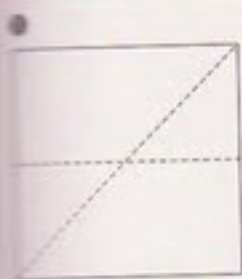

①のような折り線をつける

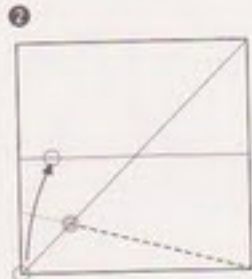

② ○印を合わせて○印の交点まで折る

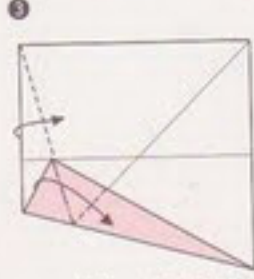

③ 角をつまんで折る

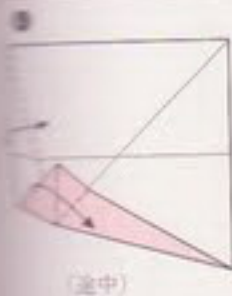

(途中)

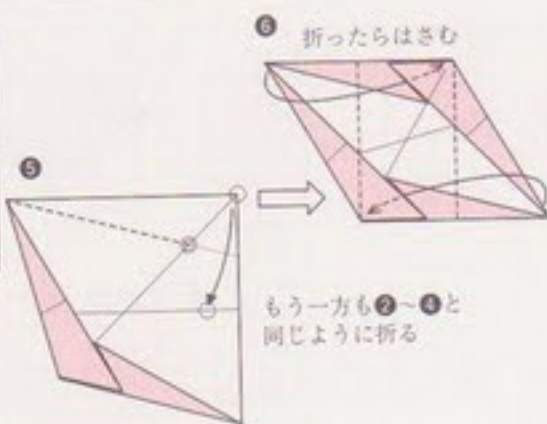

⑤ 折ったらはさむ

もう一方も②～④と
同じように折る

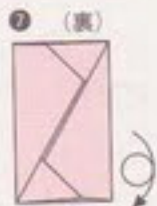

⑥ (裏)



⑦ (表)

便利包み 1

ぼち袋にする：(15cm×15cm)

封筒にする：(25cm×25cm)

小さい紙で折るとぼち袋に、大きい紙で折ると封筒になります。

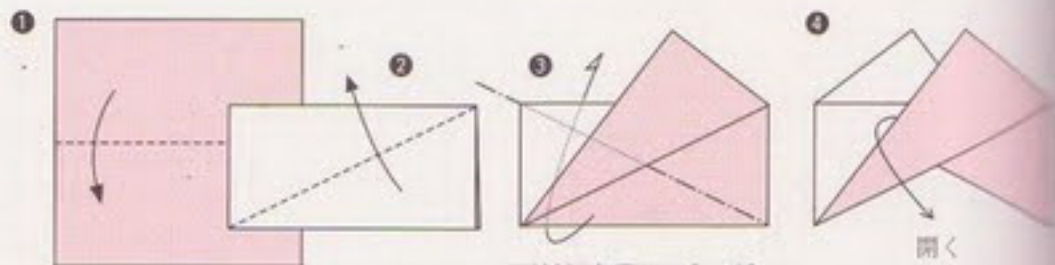

反対側も同じように折る

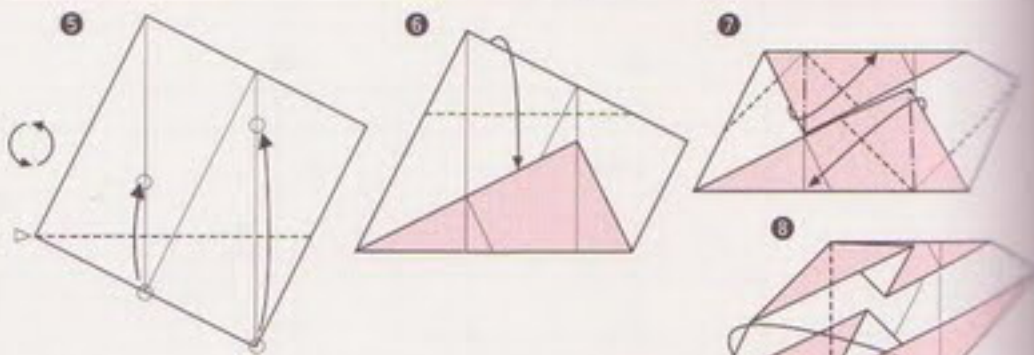

△印のところで○印を合わせて折る

折ったらはさむ

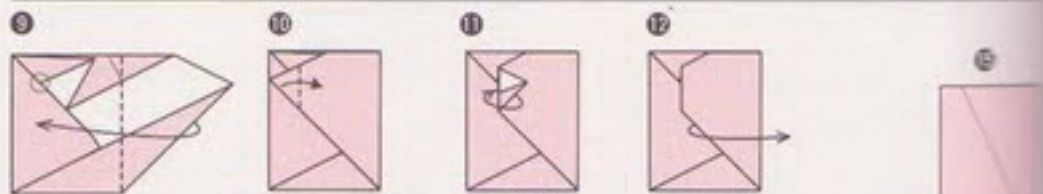

9の○印のところで折るかえす

内側に折りなおす

開く

どちらを表にしてもよい

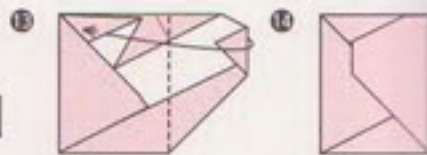

便利包

ぼち袋にする：

封筒にする：

正方形から



○印を合わせて折る。はさむ

ど

便利包み 2

紙のサイズ： $(15\text{cm} \times 15\text{cm})$
 封筒のサイズ： $(25\text{cm} \times 25\text{cm})$

正方形やいろいろな比率の長方形から折ることができます。



▶正方形から◀

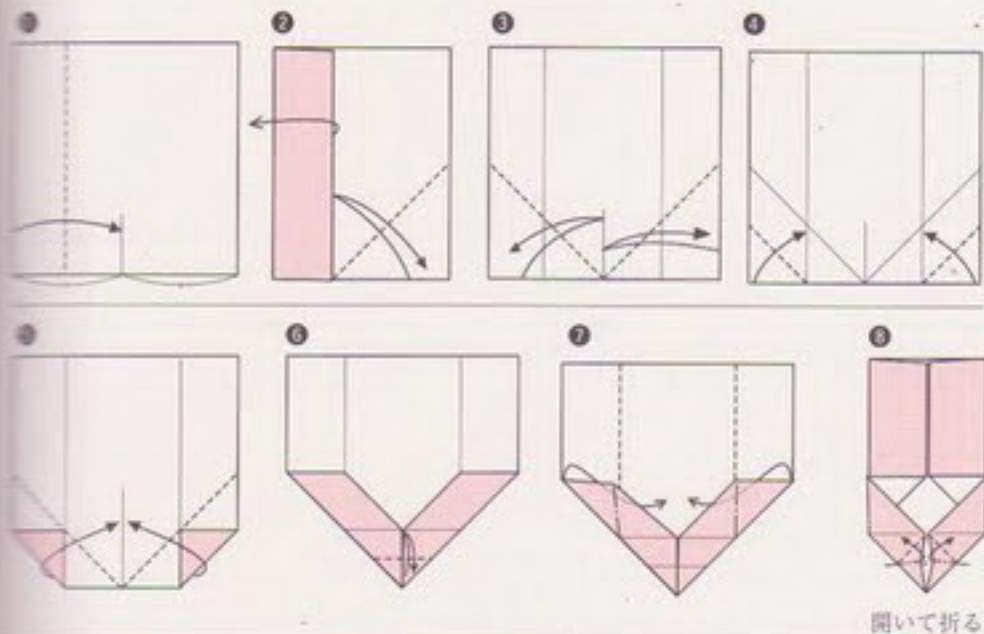

開いて折る

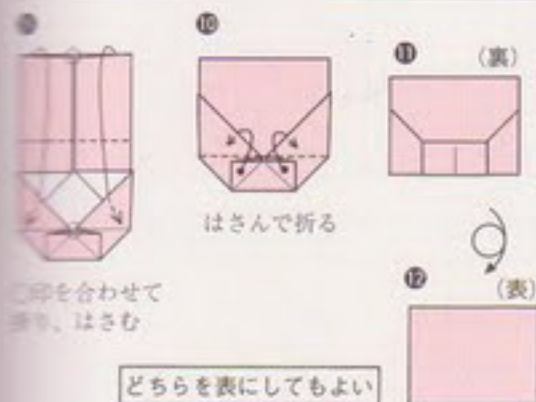

▶長方形から◀

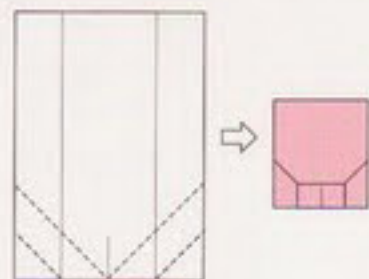

角(かど)おとし

A4判 (210×297mm) あるいは
B5判 (182×257mm) が基準

長方形のかどが欠けた形になります。



1



2

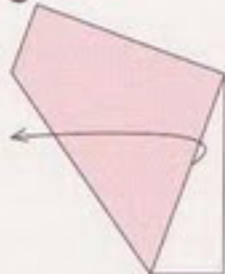

3

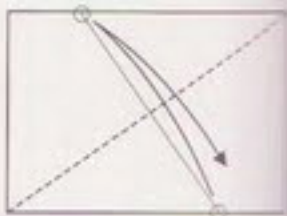

4



○印まで折る

5

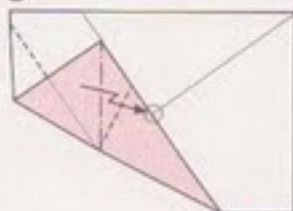

かどをつまんでひだを寄せ
○印に合わせて折る

6

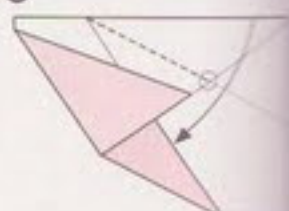

7

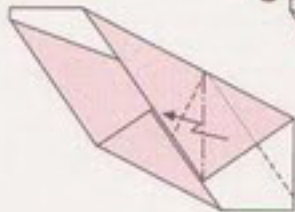

8



先を中にしまう

9



○印ななめのへりが中央にくる
ように折ってはさむ

10



四角包み

A4判 (210×297mm) あるいは
B5判 (182×257mm) が基準

1



中心だけ折る

2



いったん

3

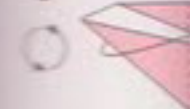

※横置き変わり

四角包み・ななめはね

基本型 (210×297mm) , B5判 (182×257mm) が基準
 大きくしたいときは2つ切りや4つ切りにする



① 中心だけ折り線をつける



② ヘリを中心に合わせて折る

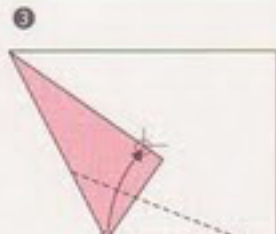

③ 中心に合わせて折る

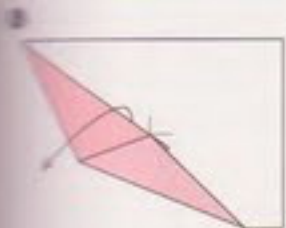

④ いったん開く



⑤ 中割り折り

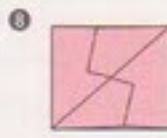
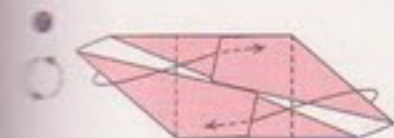

▶ 模様変わり ◀



以下①からと
 同じように折る



つまみ折りたとう A, B, C, D

15cm×15cmの正方形が基準

ちょっとした違いで4つのバリエーションができます。



▶ A ◀

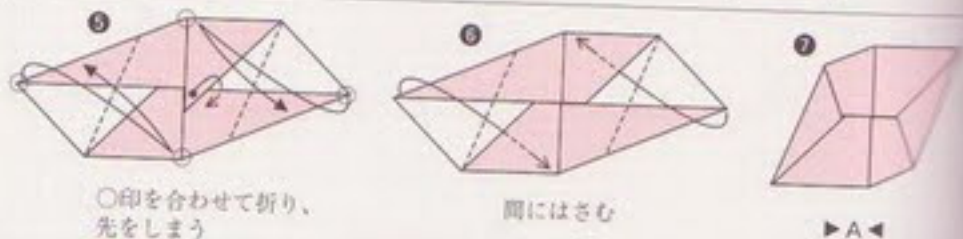
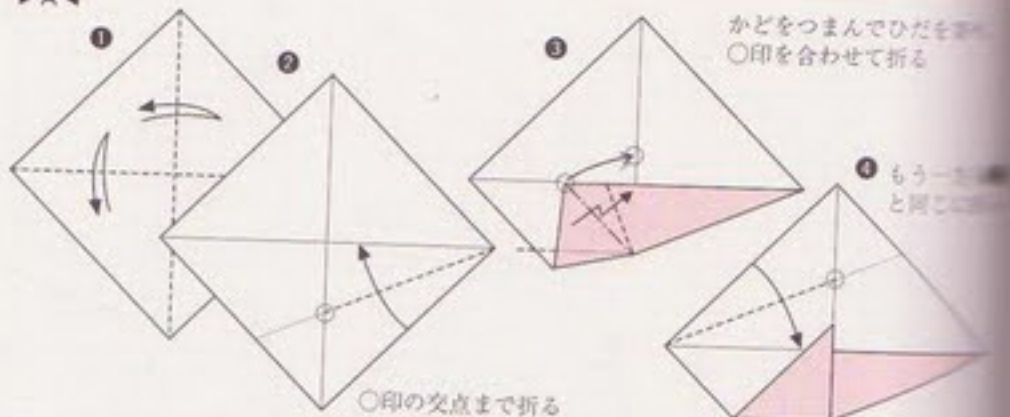

▶ B ◀ Aの③から

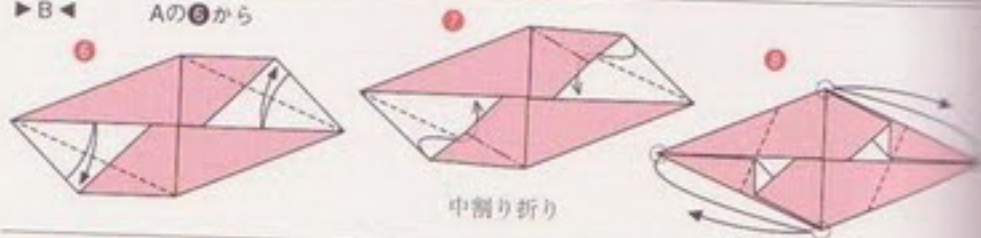

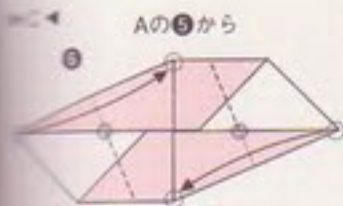

5 Aの⑤から
○印を合わせて○印の交点まで折る

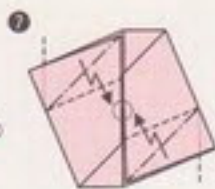

7 かどをつまんでひだを寄せ、○印の中央に合わせて折る

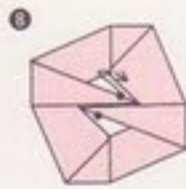

8 先をひだにはさむ

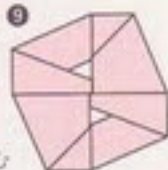

▶C◀

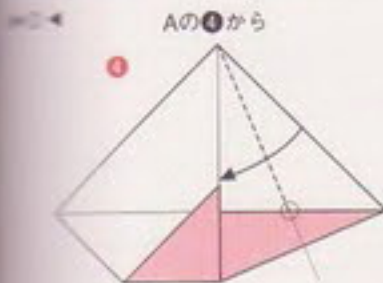

1 Aの①から
○印の交点まで折る

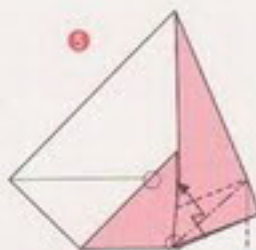

3 かどをつまんでひだを寄せ、○印を合わせて折る



5 下をはずして開く



7 ○印の交点まで折る

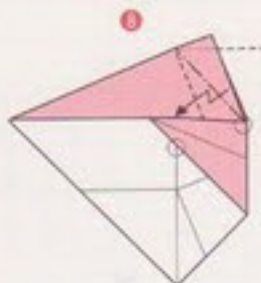

9 かどをつまんでひだを寄せ、○印を合わせて折る

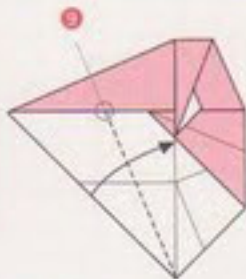

13 折り線どおりに内側に折る



15 折って先をはさむ



17 ▶D-1◀ 先を内側にいれた場合



19 ▶D-2◀ 先を外側に出した場合

かど鶴の包み

A4判 (210×297mm) あるいは
B5判 (182×257mm) が基準

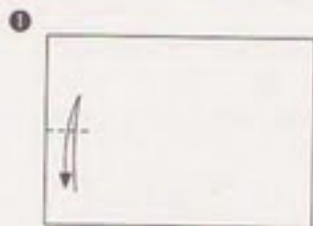

端だけ折り線をつける

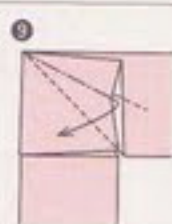
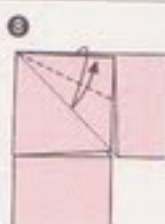
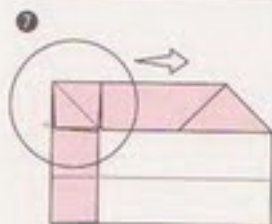
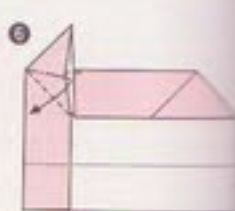
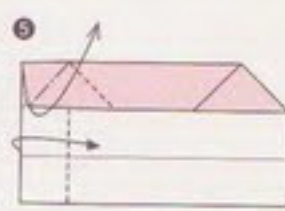
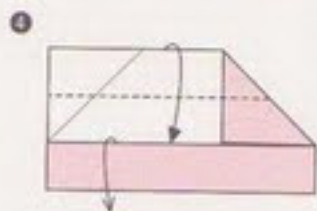
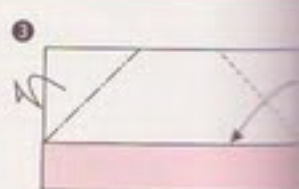

ふくろを開いてつぶす

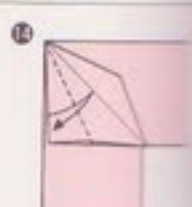
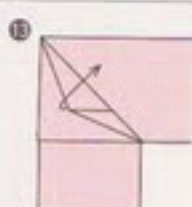
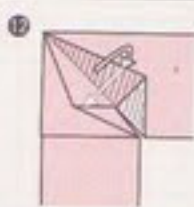
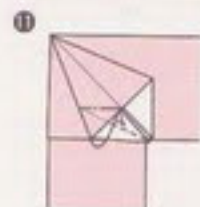

斜線の部分を中割り折り
して、下にしまう

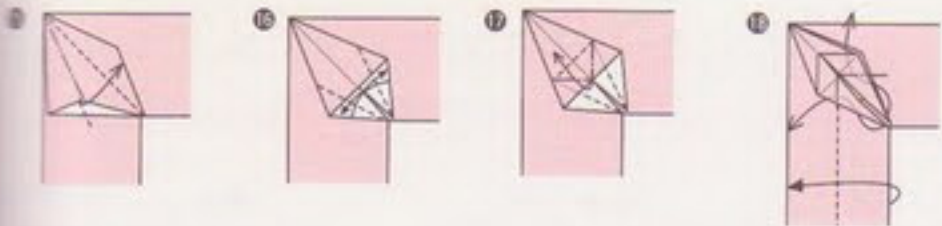

中割り折り

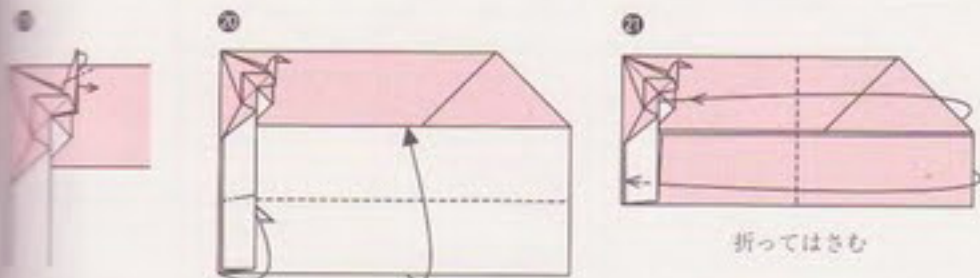

折ってはさむ

左は中割り折り



変更わり 62ページ③から

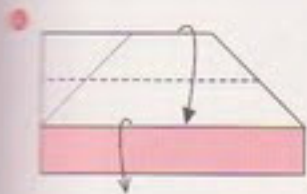
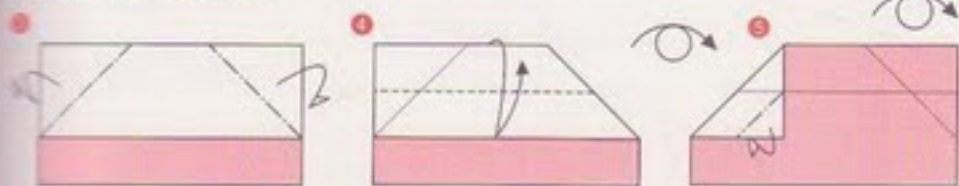

62ページ③からと
同じように折る

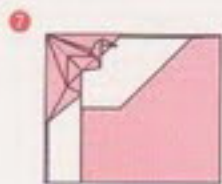

つまみ折りたとう E-たすき

15cm×15cmの正方形が基準

60ページのたとうと兄弟です。

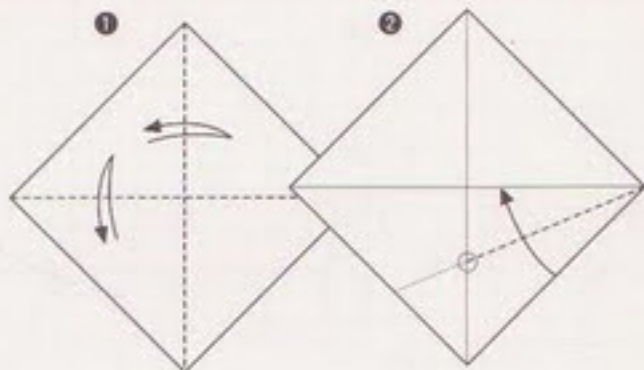

○印の交点まで折る

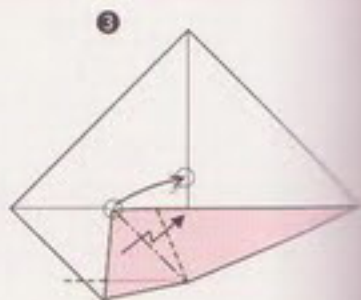

かどをつまんでひだを寄せ、
○印を合わせて折る

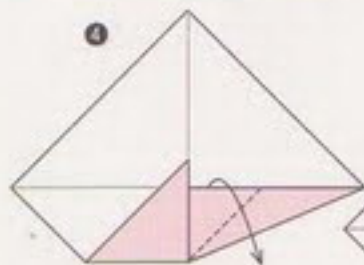

開く

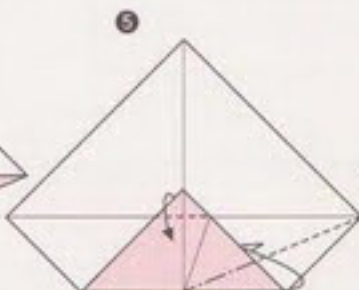

右は中割り折り

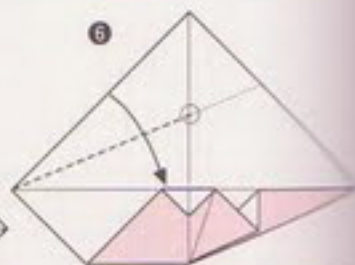

以下③からと
同じように折る

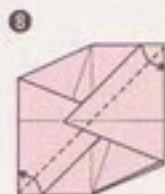
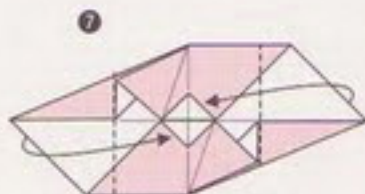

辺を合わせて
折る

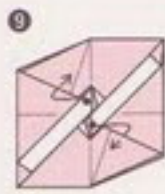

先をポケット
にしまう



鏡折り

15cm×15cmの

正



中央だけ折り
線をつける

鏡折り



「正」と「鏡」



▶B◀ 正

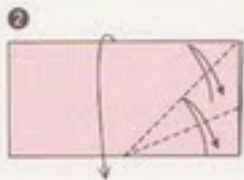
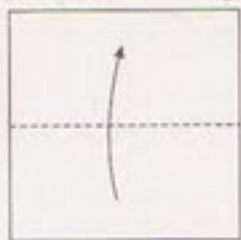

折り線をついたら開く

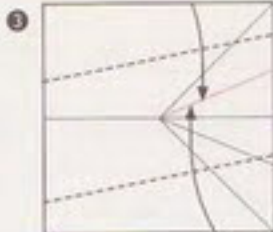

色を付けた線に合わせて折る

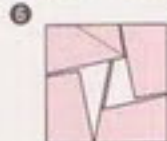
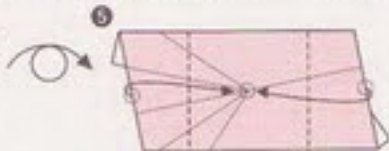
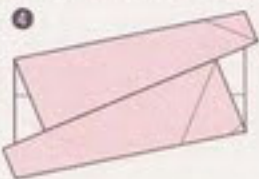

みんな開く

鏡折り

「正」の③から。位置を変える

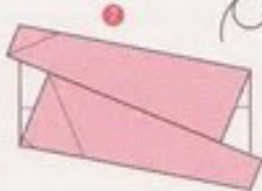
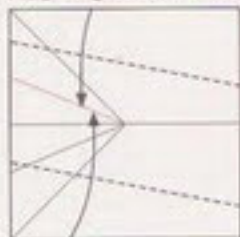

みんな開く

「正」と「鏡」を重ねる

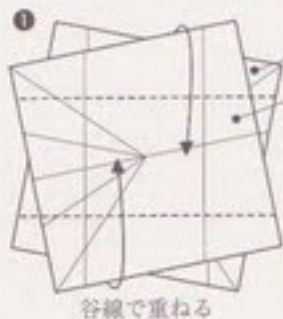

外：正
内：鏡折り

谷線で重ねる



互い違いにはさむ



▶B◀

鏡折り包

A4判 (210×297mm)
小さくしたいときは2

▶A◀ 正



鏡折り



鏡折り包み-長方形A,B

A4判 (210×297mm) , B5判 (182×257mm) が基準
 小さくしたいときは2つ切りや4つ切りにする



▶A◀ 正

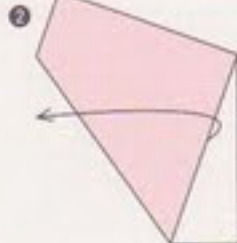
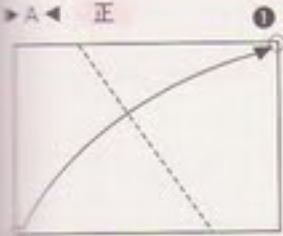

中央部だけ折り線をつける

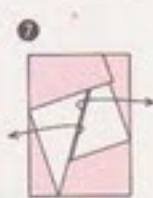
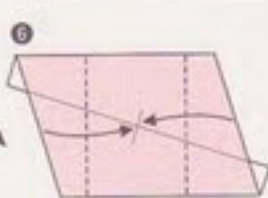

みんな開く

鏡折り

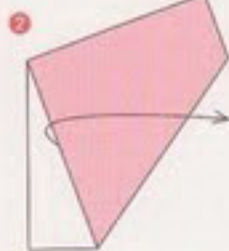
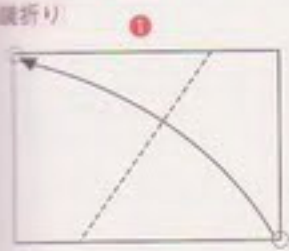

中央部だけ折り線をつける

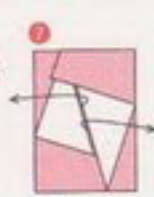
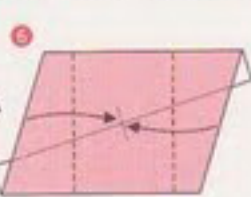
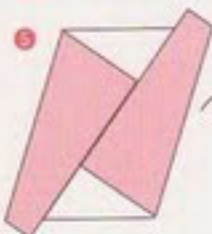

みんな開く

「正」と「鏡」を重ねる

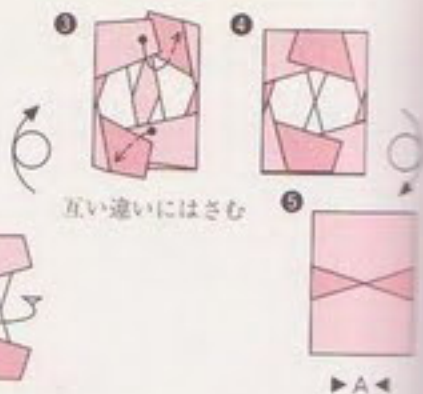
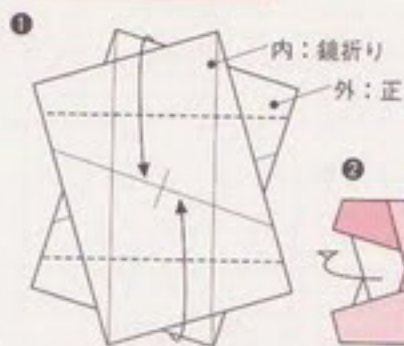

▶ B ◀ 正

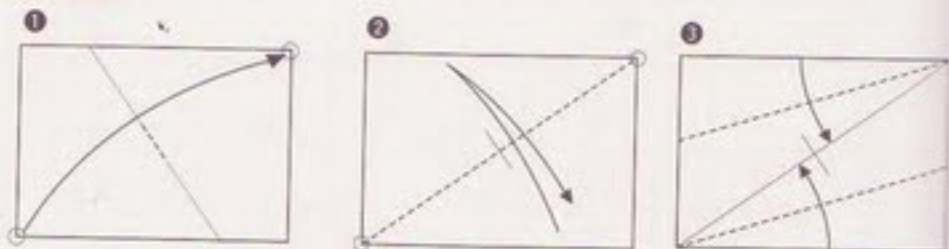

中央部分だけ折り線をつける

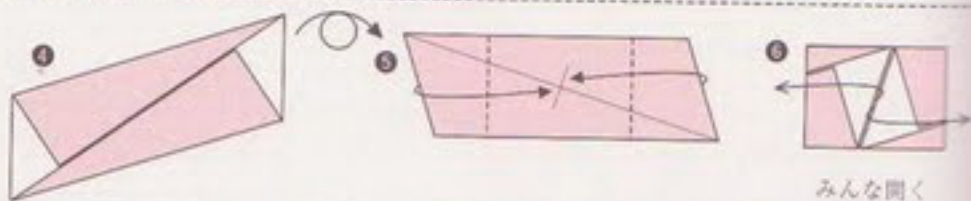

鏡折り

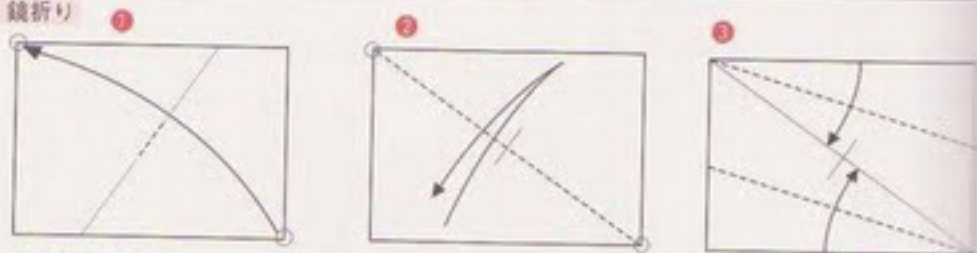

中央部分だけ折り線をつける

重ねた

15cm×15cm

内

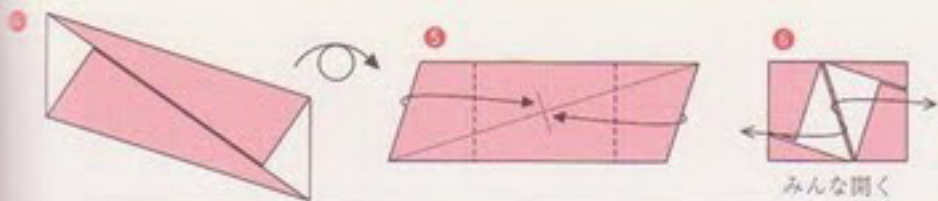

『正』と『鏡』を重ねる

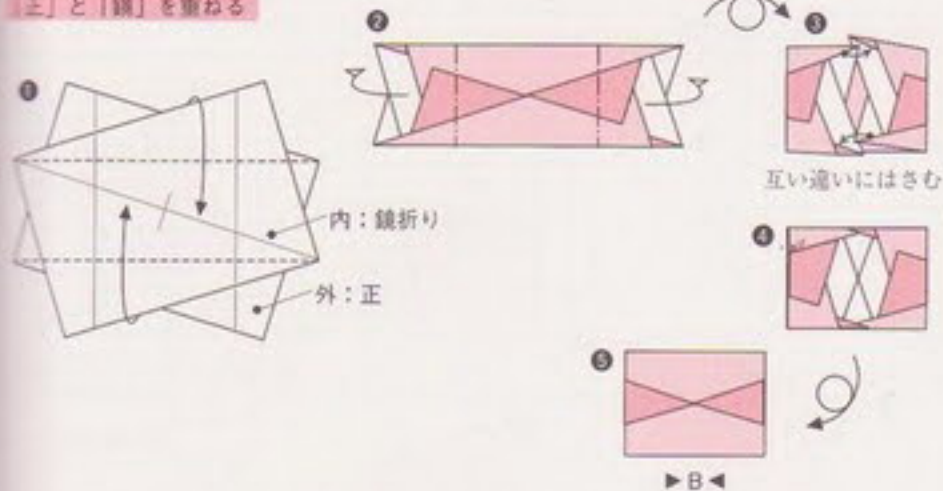

重ねたとう四角・A, B



内と外と2つのたとうを重ね合わせてひとつにします。もよう変わりもできます。またそれぞれ単独でも使えます。

15cm×15cmの正方形が基準

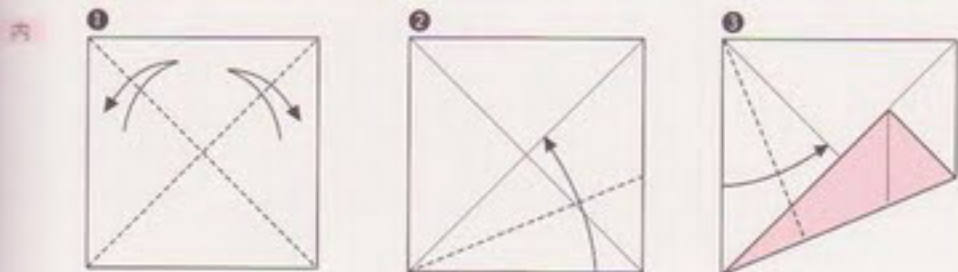

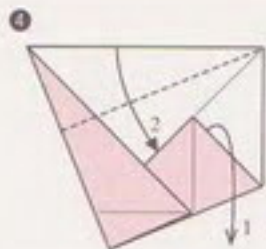

番号順に下を開いてから折る

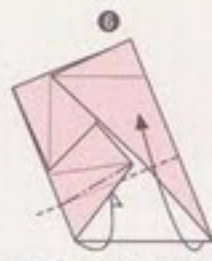
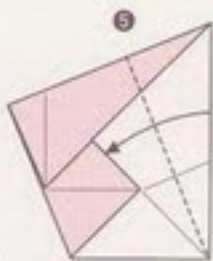

端を中に折り入れる



内のたとう

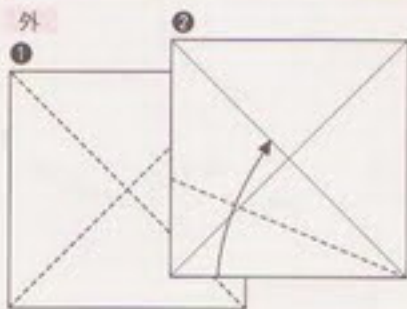

外

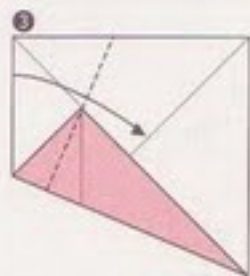

番号順に下を開いてから折る

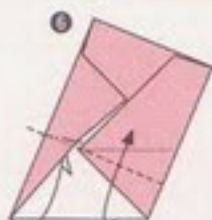
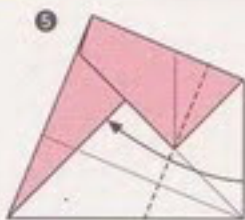
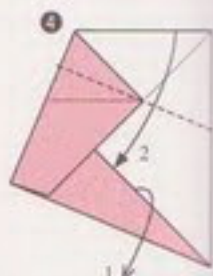

外のたとう



「内」と「外」を重ねる

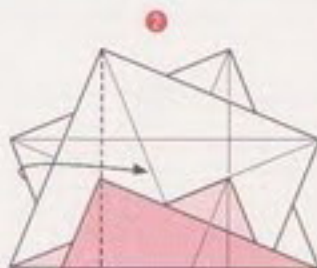

下は中割り折りしはさみこむ



内のたとう



②の外側の端を
図のように折り

内の方とう



下は中割り折りして
はさみこむ

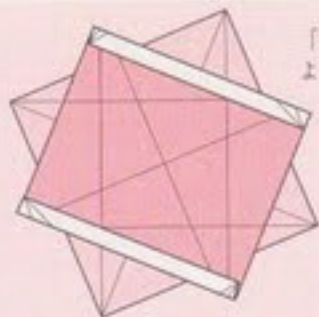

「外」の端を図の
ように折ります



裏側から折る

内の方とう

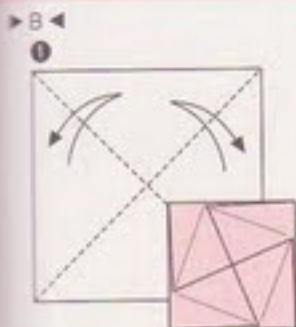

内の方とうを重ねる

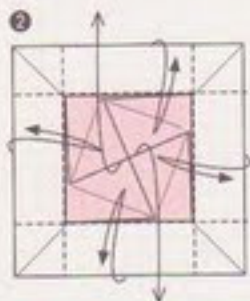

折り線をつけたら中を開く

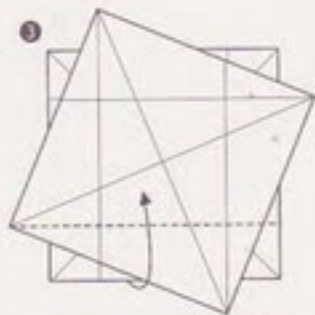

2枚いっしょに折る

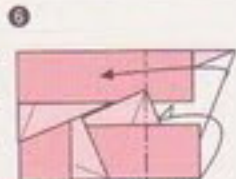
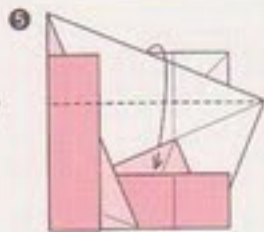
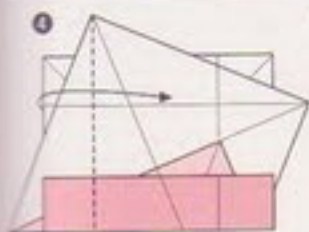

下は中割り折りして
はさみこむ



⑩の外側の端を
図のように折ります

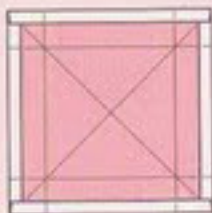
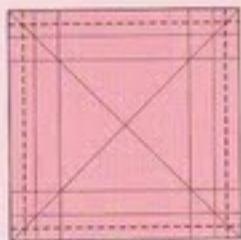

重ねたとう八角・A,B,C,D,E,F,G

15cm×15cmの正方形が基準

たくさんのバリエーションができます。

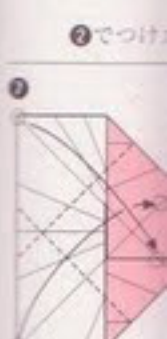
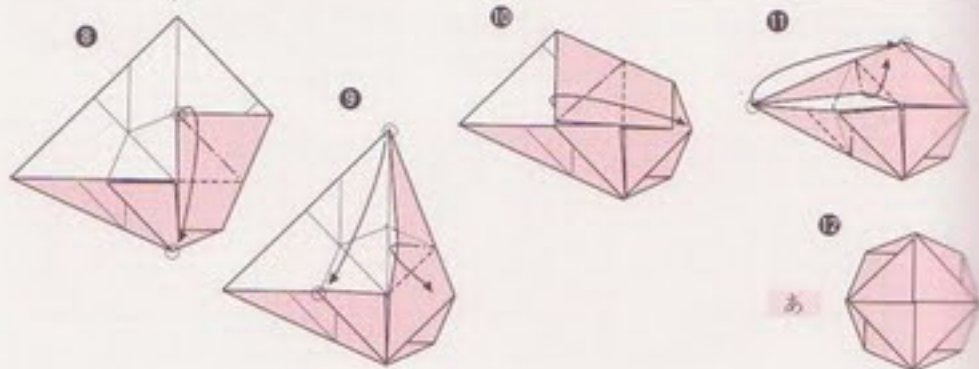
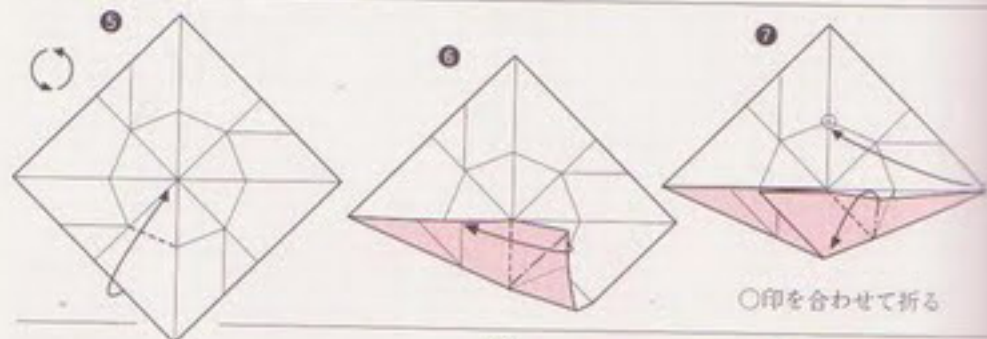
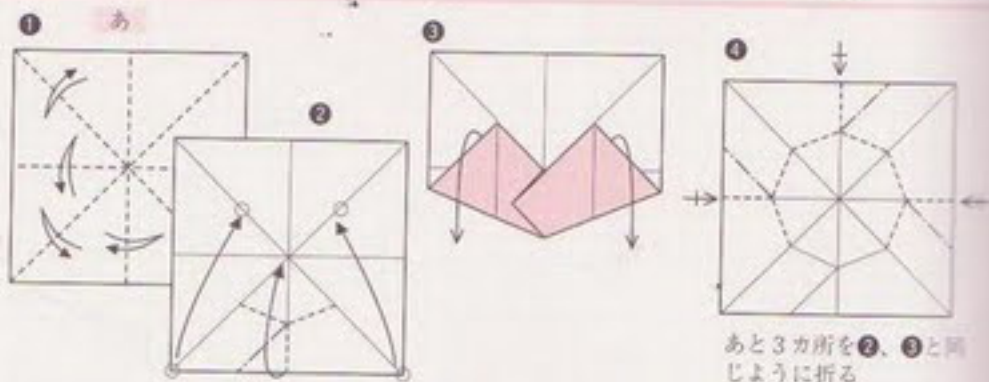

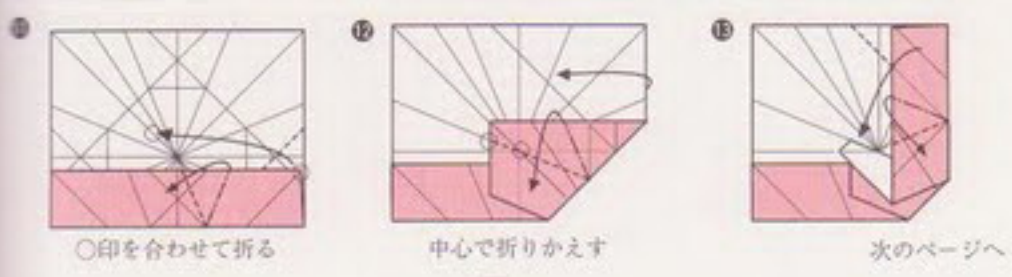
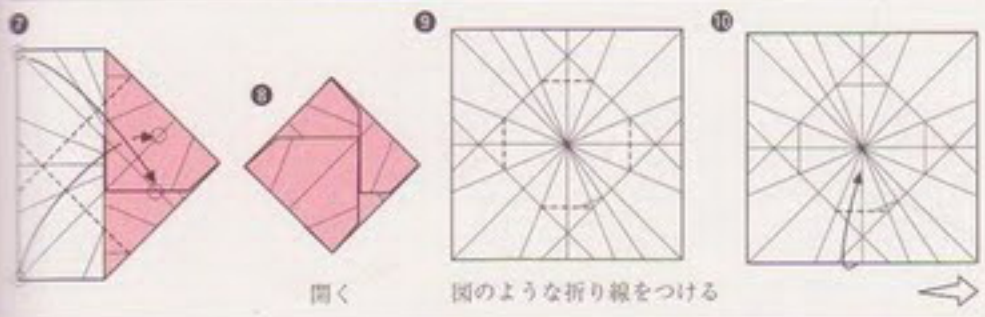
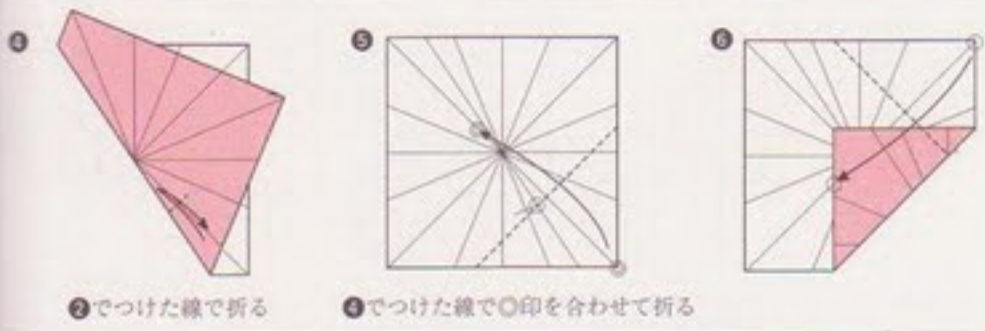
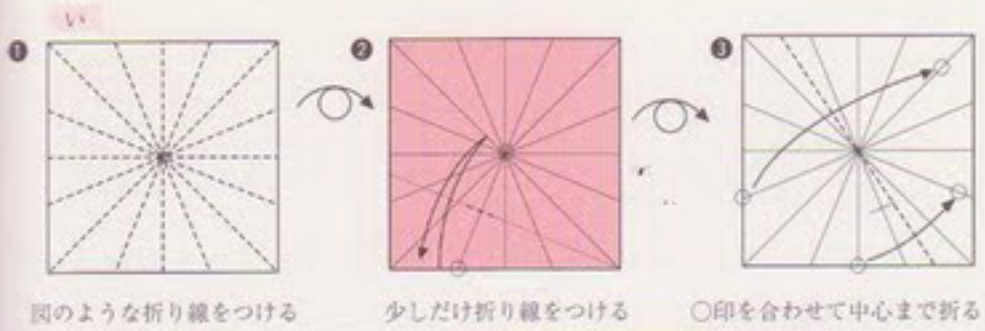

▶D◀ 内:い 外:あ

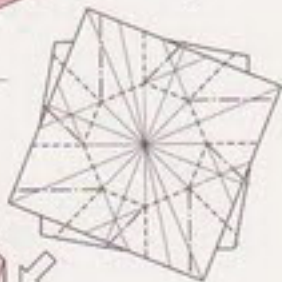
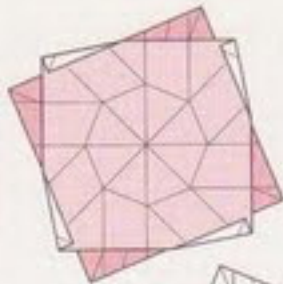
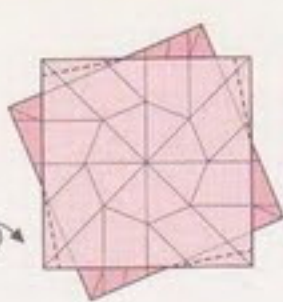
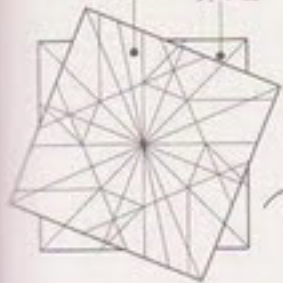

▶E◀ 内:い 外:あ



重ねたら折り線
どおりにまとめる



折り線どおり
にまとめる

▶F◀

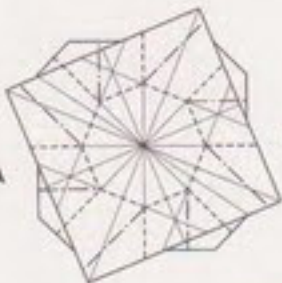
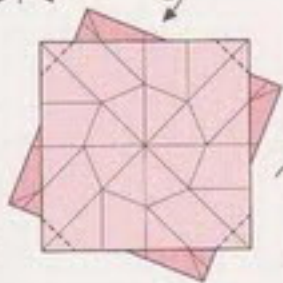

▶G◀

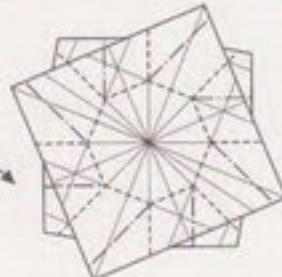
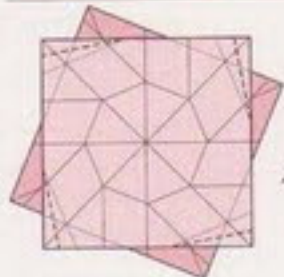

重ねたとう六角A,B

15cm×15cmの正方形が基準

これも同じものを2つ折って重ね合わせます。

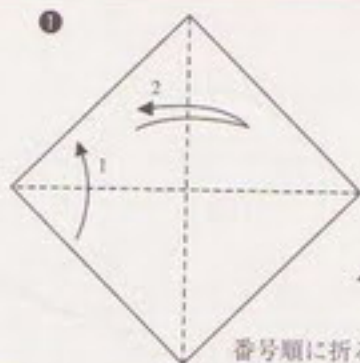

番号順に折る

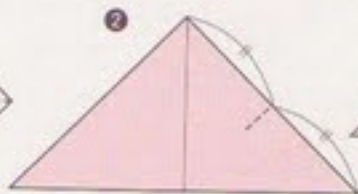

上下いっしょに折り線をつける



上だけ折り線をつける

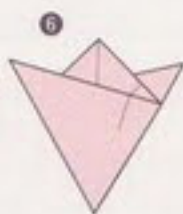
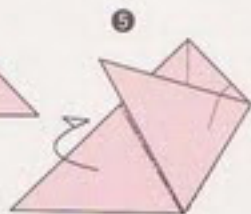
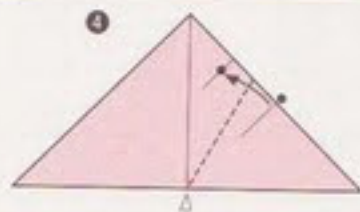

みんな開く



開く

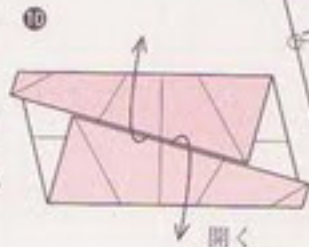
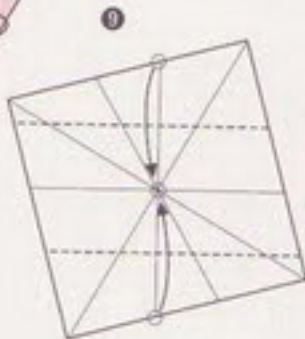

開く

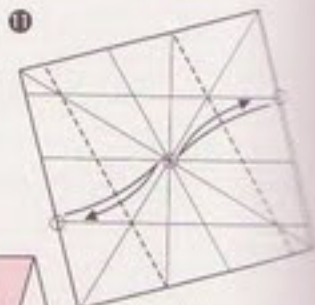

折り線をつける



○印を結ぶ線で
●印を合わせて折る

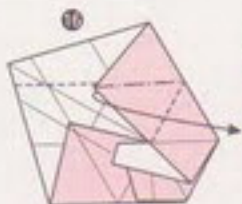
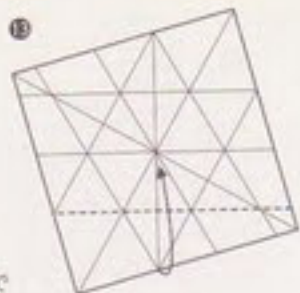

折り線にしたがって
まとめる

みんな開く

2つを開いて重ねる



重ねたら折り線
どおりにまとめる

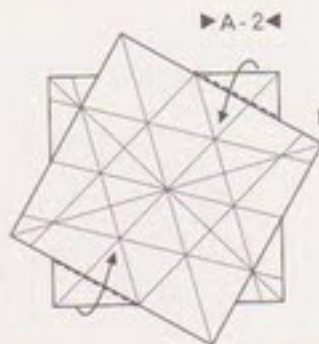

重ねたら折り線
どおりにまとめる



▶B-3◀

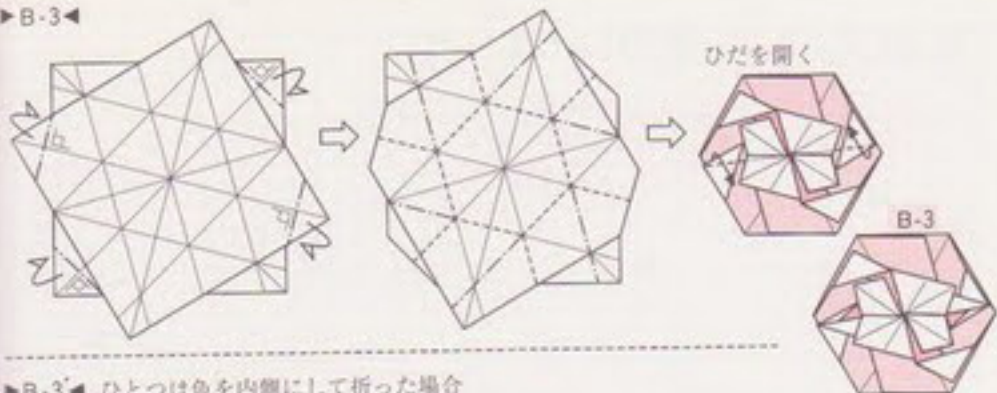

▶B-3'◀ ひとつは色を内側にして折った場合

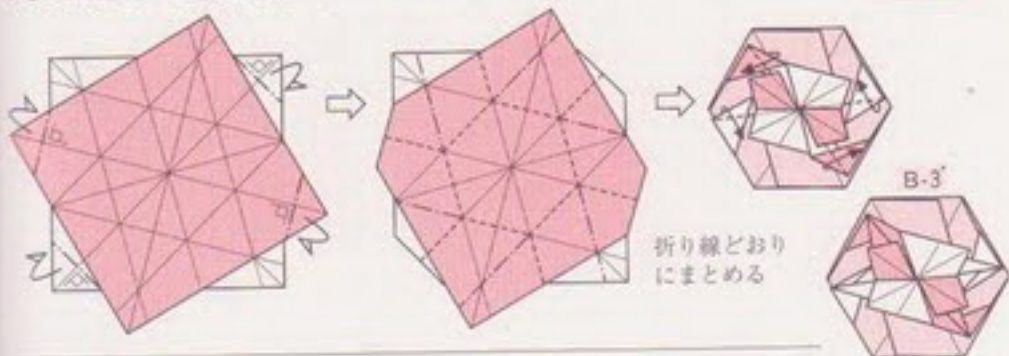

▶B-4,5◀

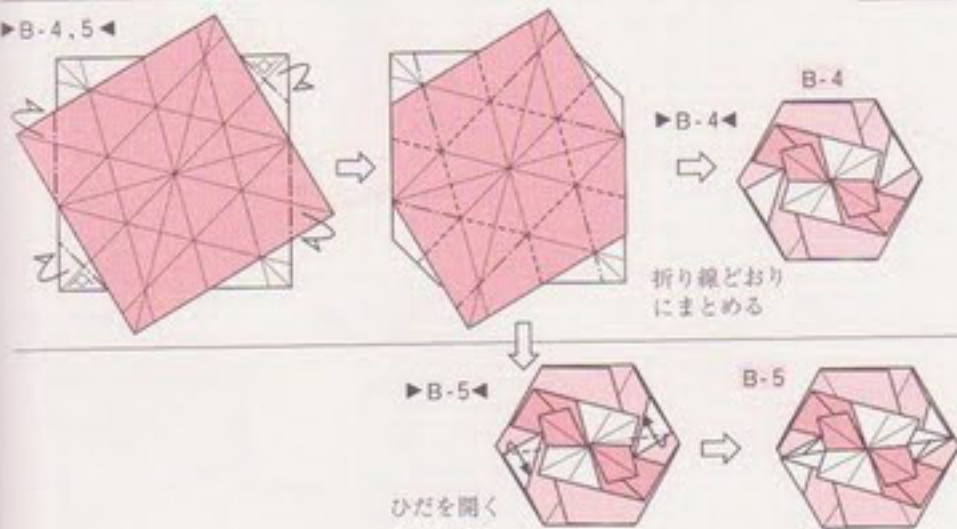

重ねたとう亀甲・A, B

15cm×15cmの正方形が基準

2種類の別々の折りを重ねて
たとうにします。

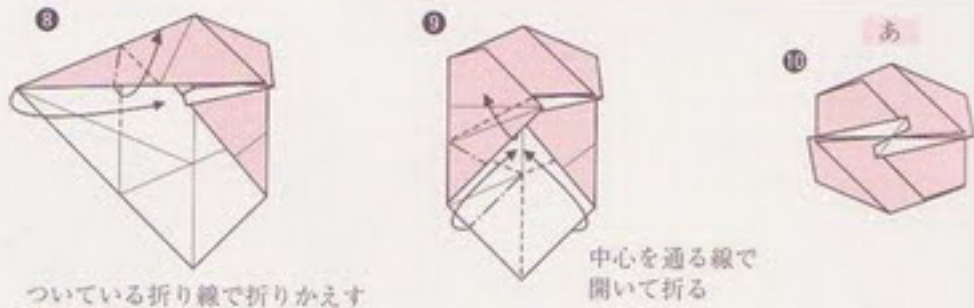
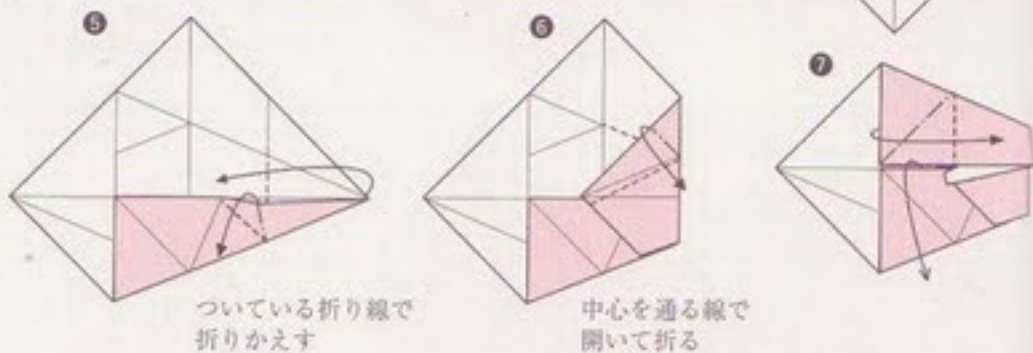
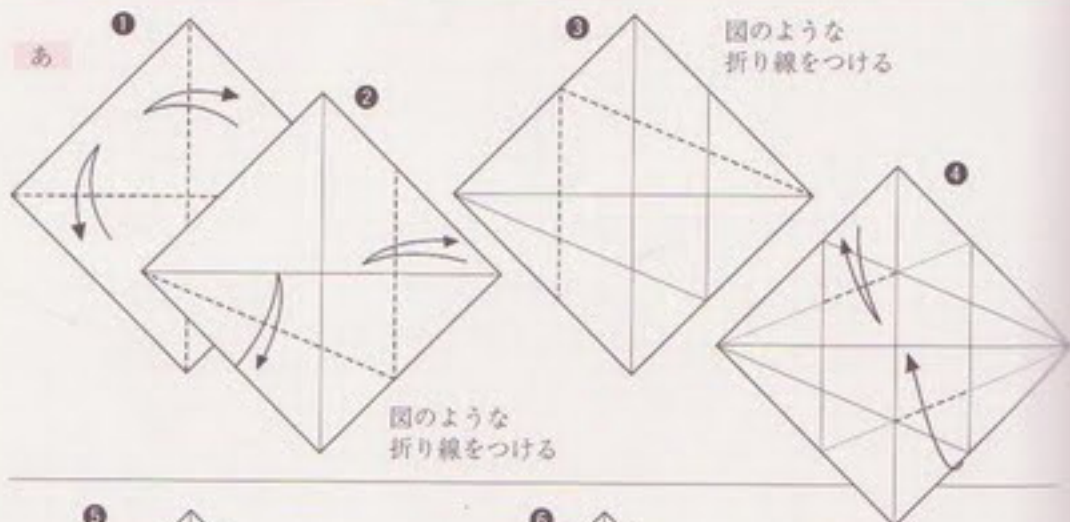

○印を合わせ
まで折る



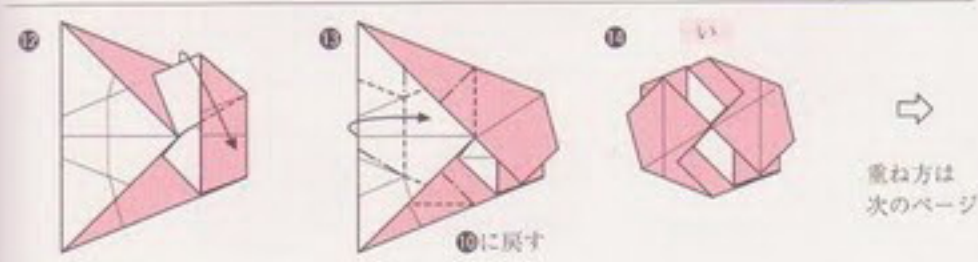
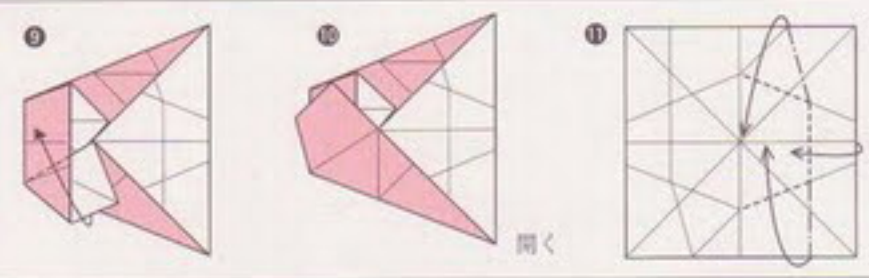
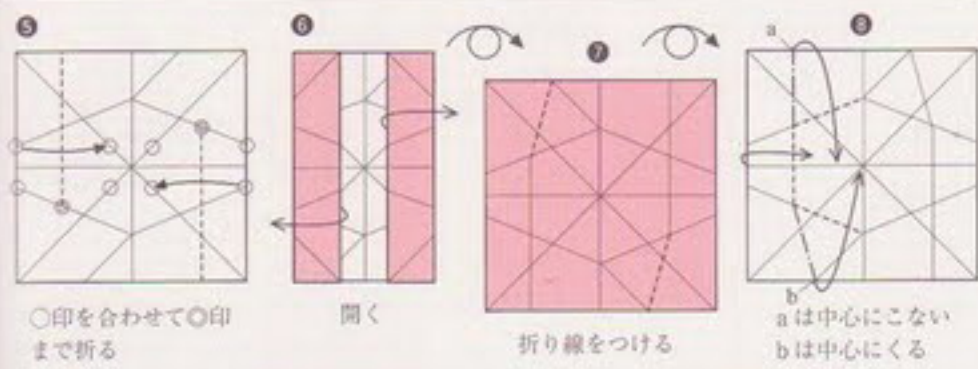
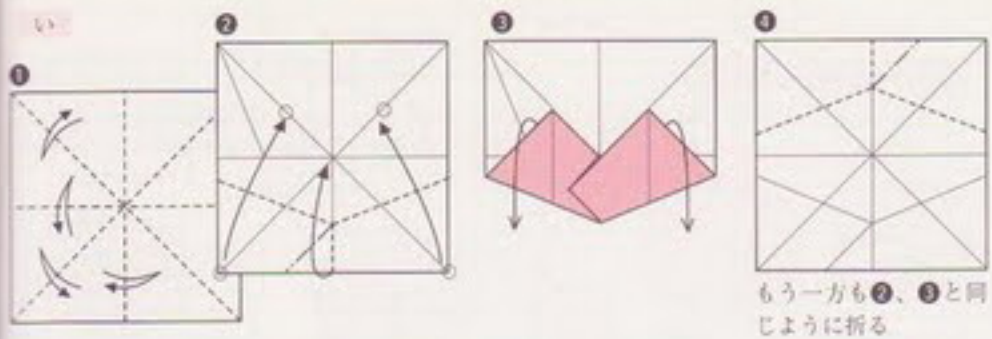

「あ」「い」を開いて重ねる

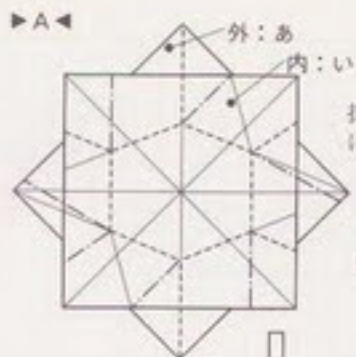
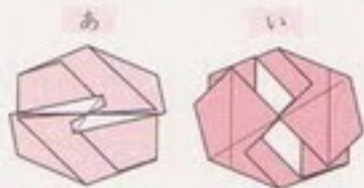

折り線どおりにまとめる

▶A-1◀

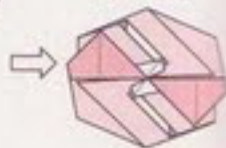

Aのバリエーション

▶A-2◀

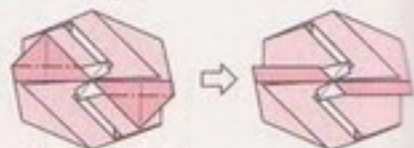

内側に折りこむ

▶A-3◀

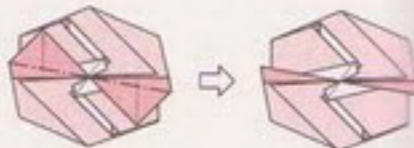

▶B◀

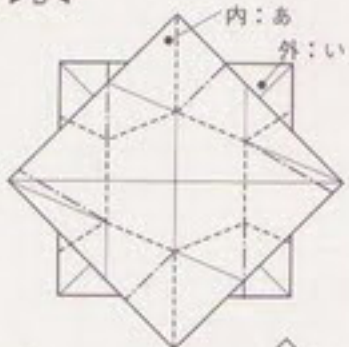

折り線どおりにまとめる

▶B-1◀



▶B-2◀

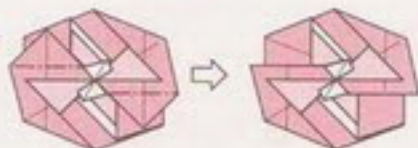

内側に折りこむ

▶B-3◀

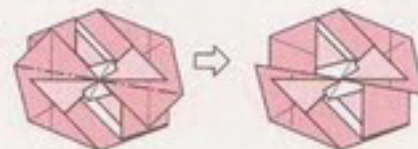

Bのバリエーション

結び帯を

A3判 (297×420)

B4判 (257×365)

無地

①



包むものを
のせて、貼る

飾り帯

②



結び帯をつける包み

A3判 (297×420mm) あるいは 85ページから始まるいろいろな結びの本体にちょうどいい
B4判 (257×364mm) が基準 包み方です。

無地

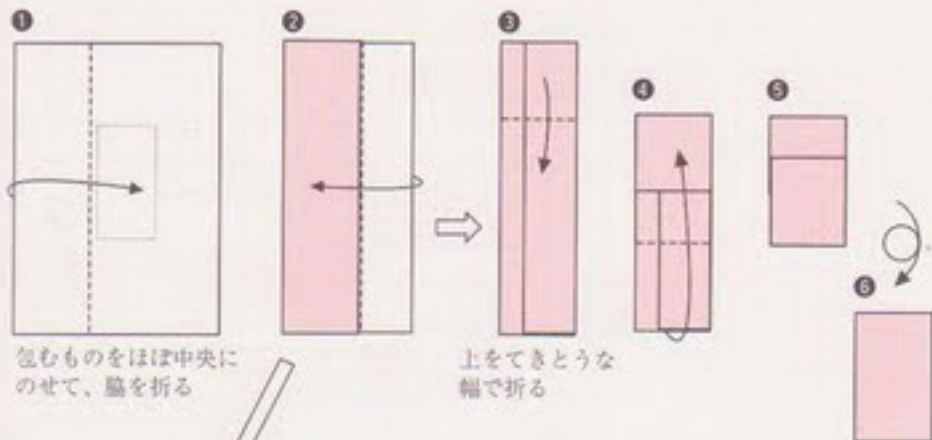

飾り帯

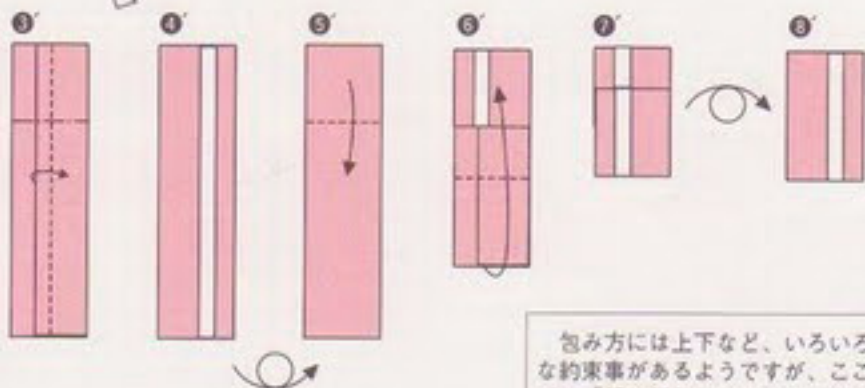

包み方には上下など、いろいろな約束事があるようですが、ここでは「折り紙」として、こだわらずに包みました。

きちんとしたい方は、その方面の書籍を参考にしてください。

四角結び・違い鍵どめ

カードに結ぶリボンや、包みの水引き代わりに、
こんな紙もときにはおしゃれです。



紙帯の寸法目安 長さ aの3倍くらい
幅 bの8分の1くらい
太い紙帯ほど長く必要。

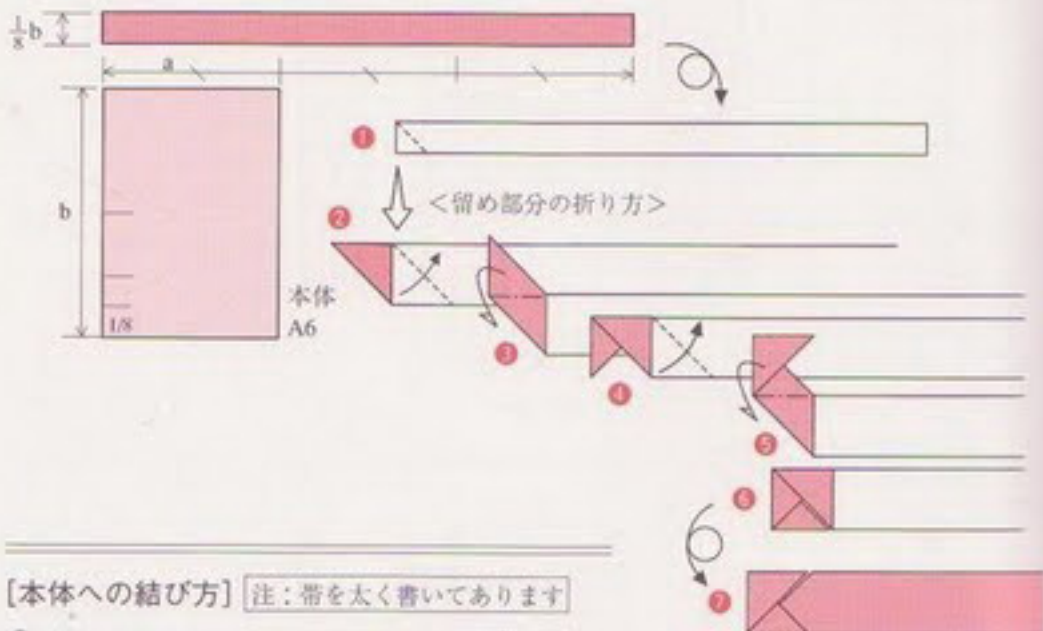

[本体への結び方] 注：帯を太く書いてあります

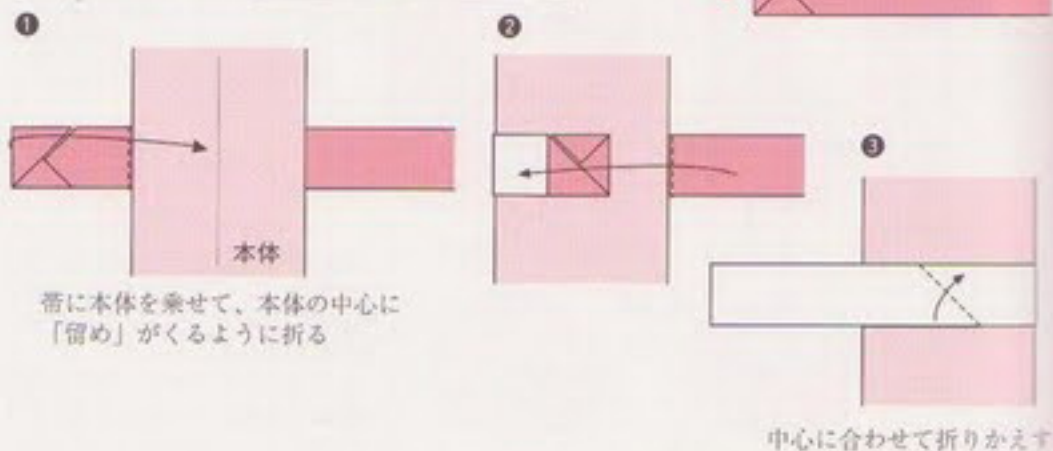

帯に本体を乗せて、本体の中心に
「留め」がくるように折る

中心に合わせて折りかえす

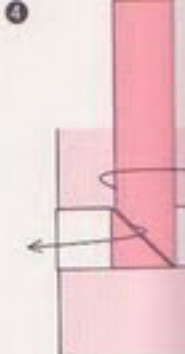

いったん開き本



⑫、⑬で組み
⑭のように、



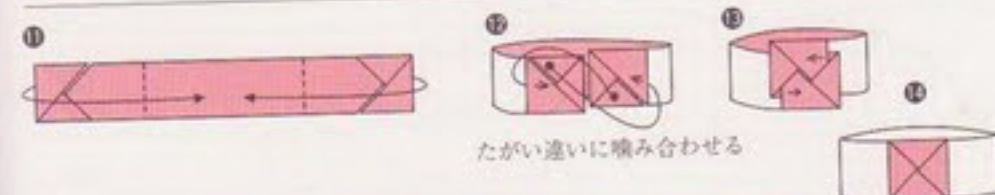
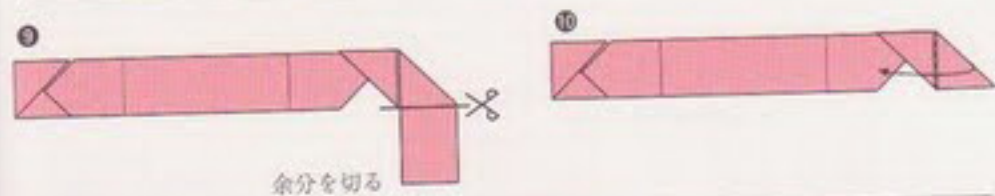
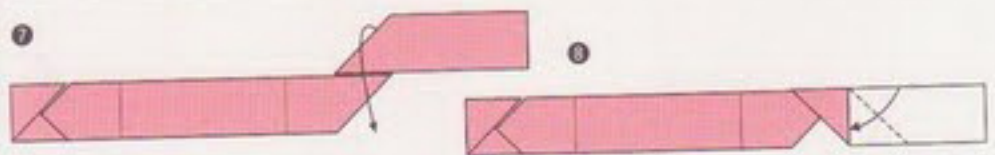
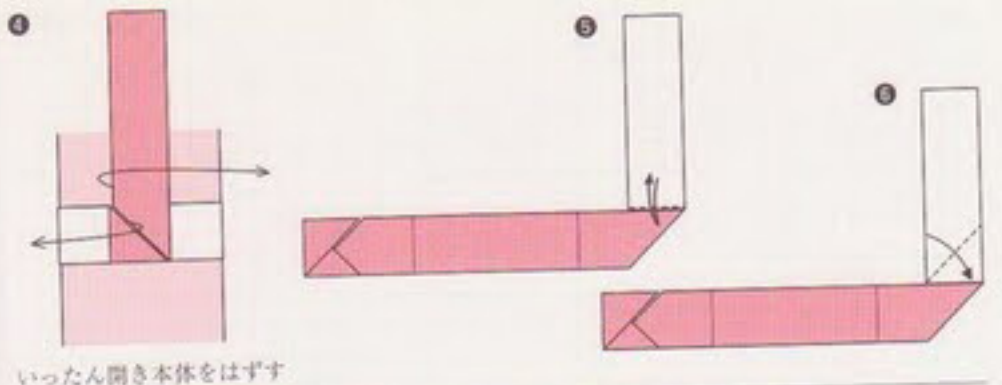

⑫、⑬で積み合わせにくいときは、先を⑭のように切り取るとよい。
 ⑭のように、あらかじめ先を少なめに折ってもよい



本体との組み
 合わせは
 次のページ



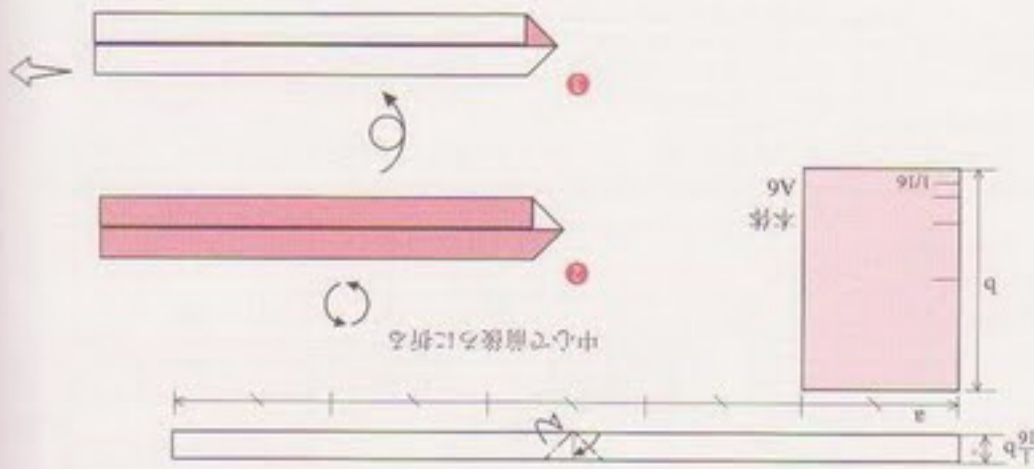

注：図解は帯を大きく書いてあります

紙帯の寸法目安
 長さ a の5倍くらい
 幅 b の16分の1くらい
 太い紙帯ほど長く必要。

四角結び・立ち結び

「四角結び」よりさらに細い紙帯から折ります。

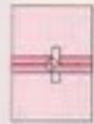

再び本体を差しこむ

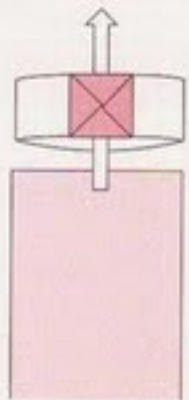
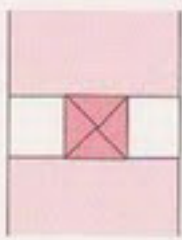

【本体への結び

帯に本

中心に合わせて

間に

[本体への結び方]

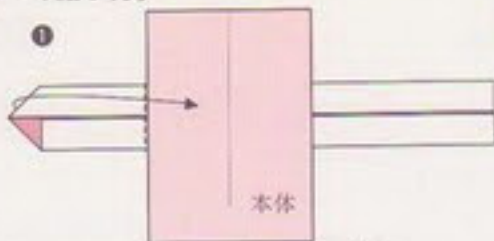

帯に本体を乗せて、気に入った位置に
(この場合中心)「留め」がくるように折る

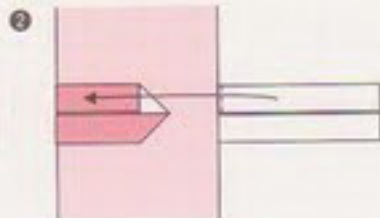

右の1本だけ折る

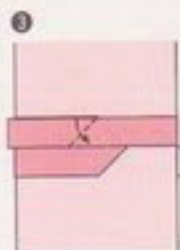

中心に合わせて折る

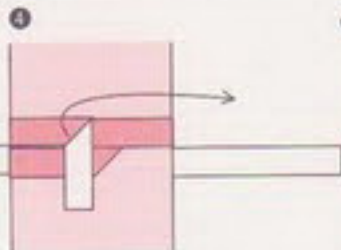

いったん開く

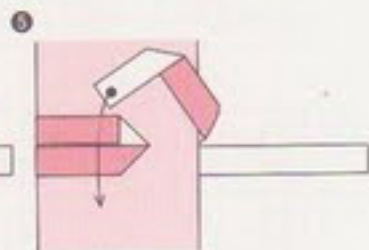

間にはさむ

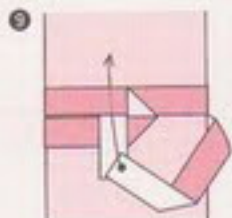
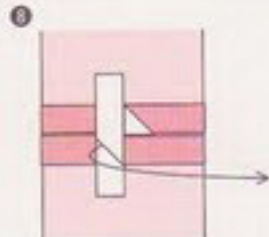
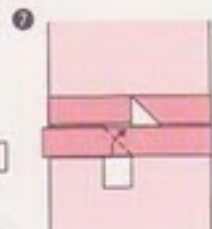
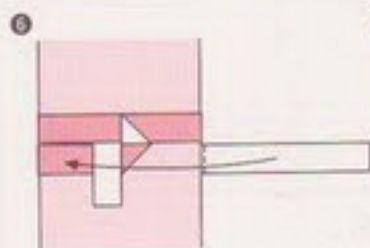

間にはさむ

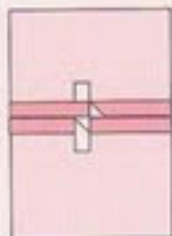
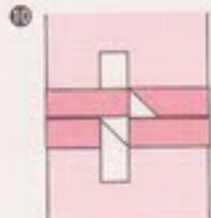

解は帯を大きく
開いてあります

六角結び・朝日(A)



それぞれの結びに固有の名前をつけましたが、図解では便宜上A、B、Cと表し、帯の寸法はここに一括して書きました。

紙帯の寸法目安

幅 b の8分の1くらい
 長さ A: a の1.8倍くらい
 B, C: a の2倍くらい
 太い紙帯ほど長く必要

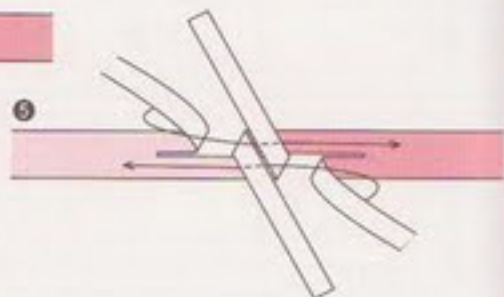
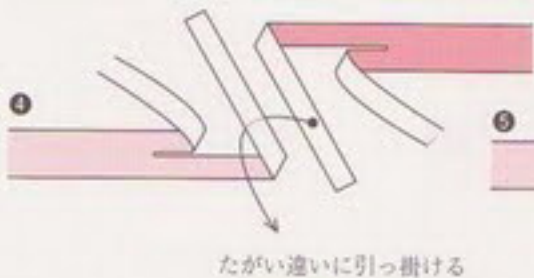
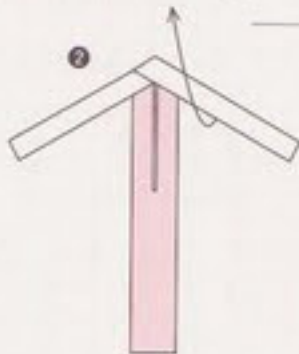
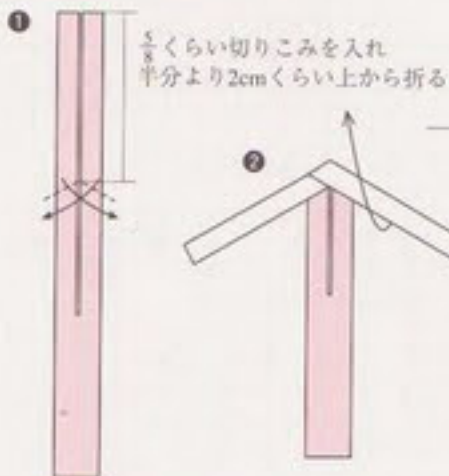
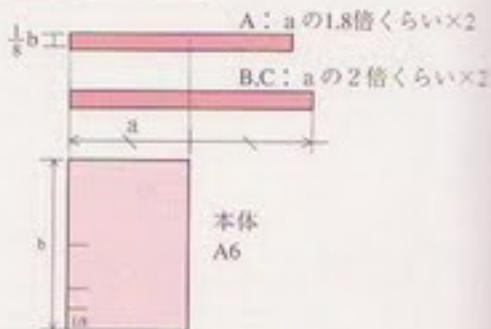

たがい違いに引っ掛ける



倍くらい×3
2倍くらい×2

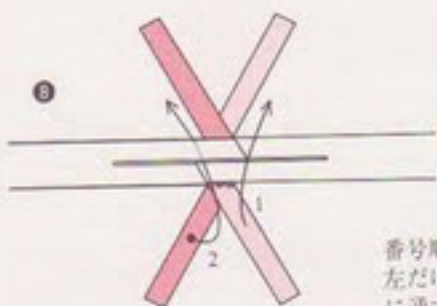
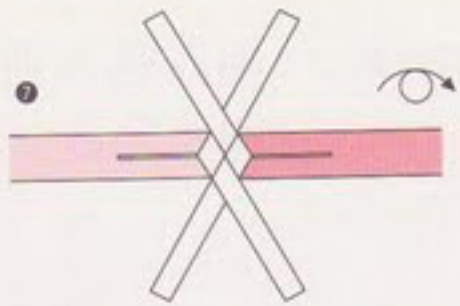
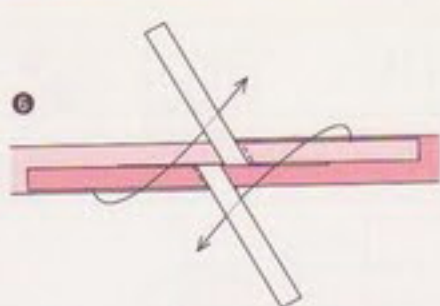

番号順に折り
左だけすき間
に通す

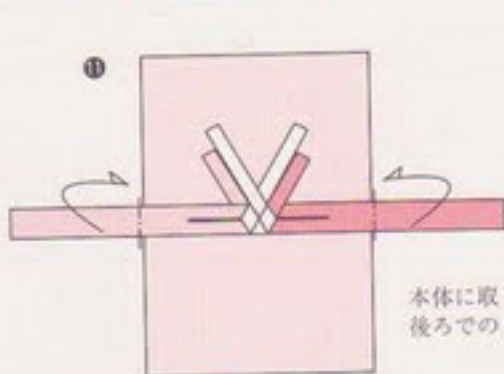

本体に取り付け、
後ろでのり付けする

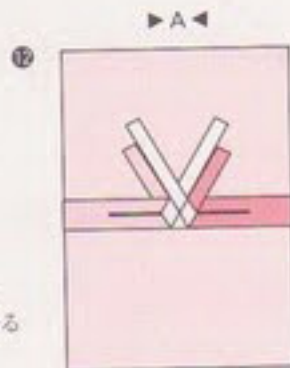

六角結び・編み込み朝日(B) 編み込み(C)

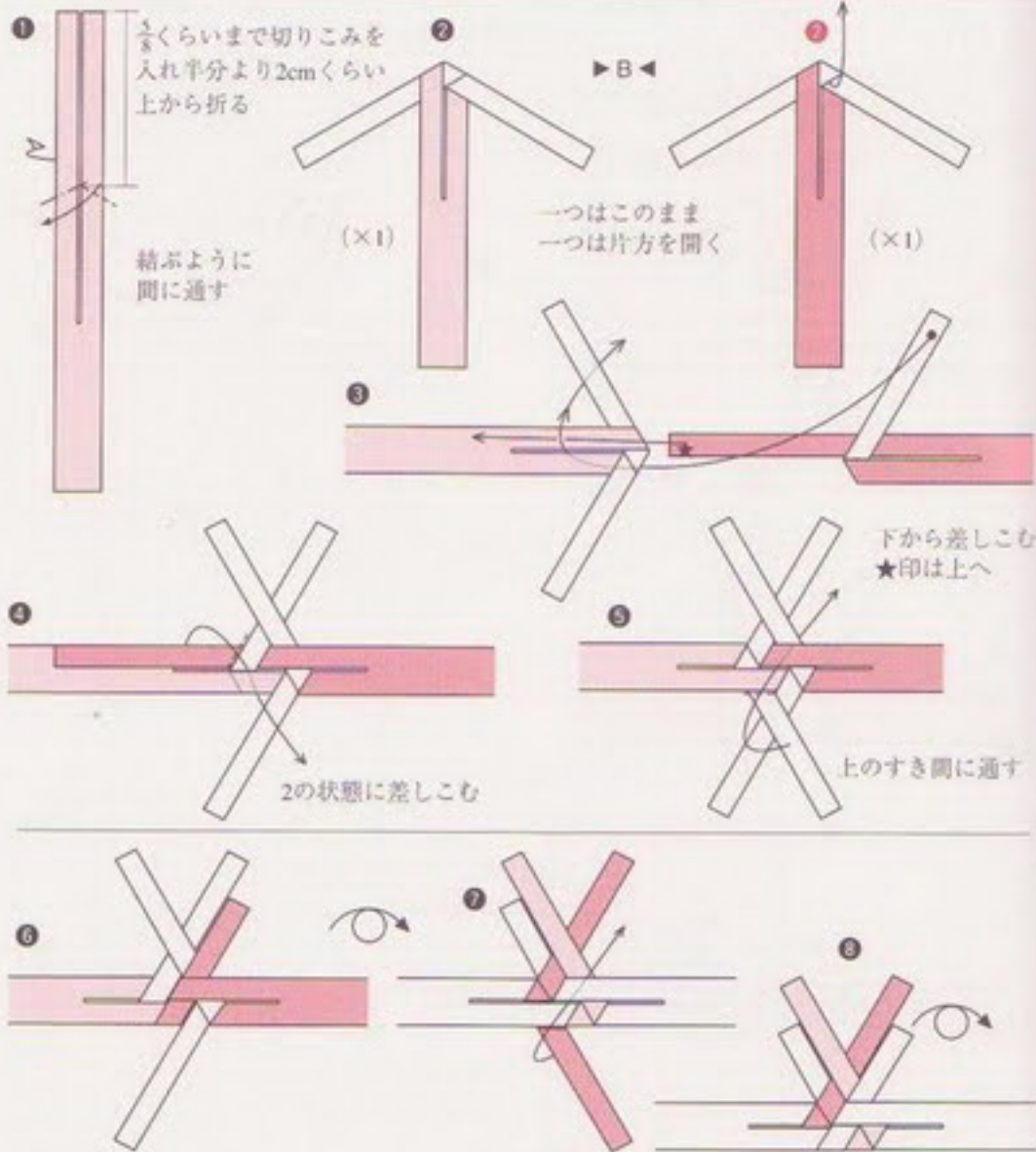
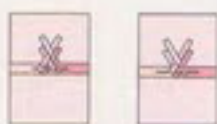

▶ C ◀ Bの5 (90)

▶ C ◀

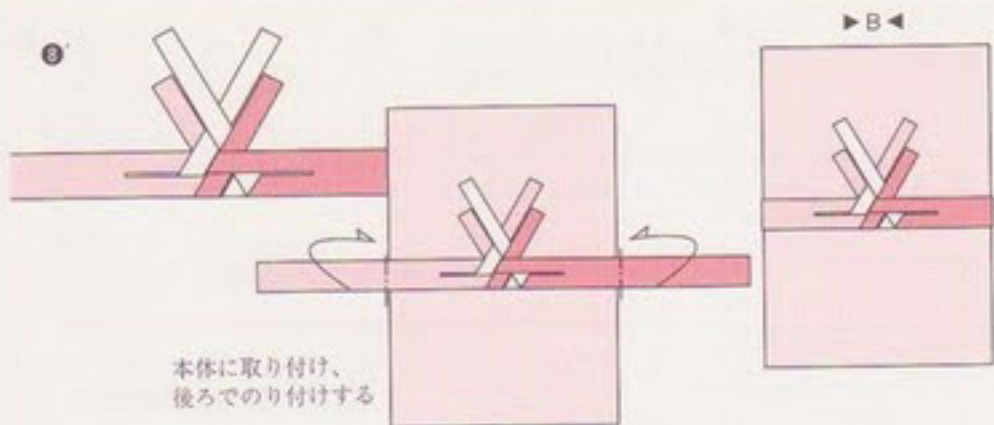

▶C◀ Bの5 (90ページ) から、間を開ける

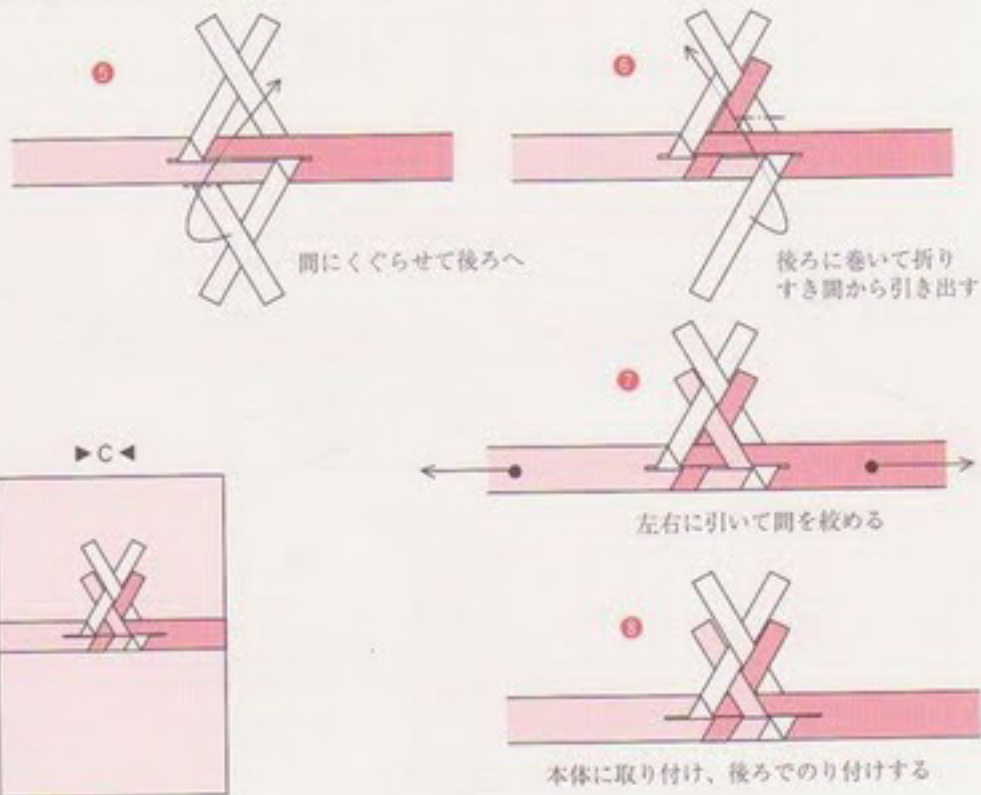

五角結び・一つ結び (A)



それぞれの結びに固有の名前をつけましたが、図解では便宜上A、B、Cと表し、帯の寸法はここに一括して書きました。

紙帯の寸法目安

- 幅 a の8分の1くらい
 長さ A: a の3.5倍くらい
 B: a の4.5倍くらい
 C: a の2倍+のりしろ
 結び2つ分の長さ
 太い紙帯ほど長く必要

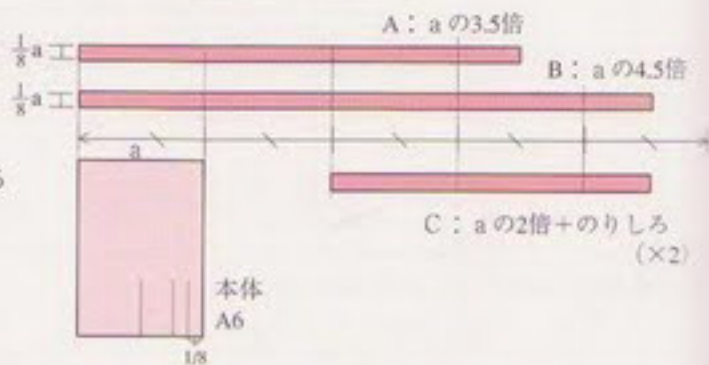

▶ A ◀

①

右に結び目を作る



②

本体の中央に結び目を置き、帯を巻く

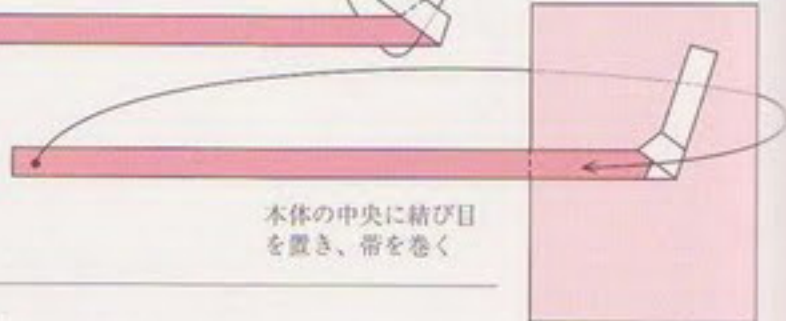

③

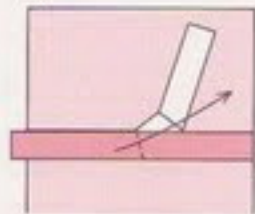

結び目のへりに合わせて折る

④

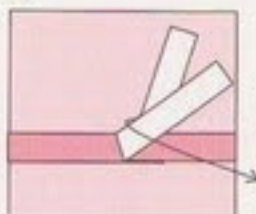

いったん戻し本体をはずす

⑤

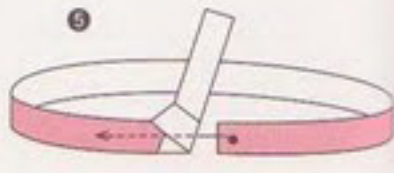

結び目の裏側のすき間に差しこむ

②



③



結び目のへり

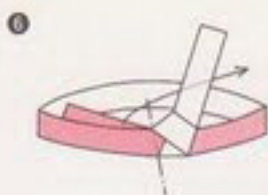

①で折った
折り目を山折りに折る

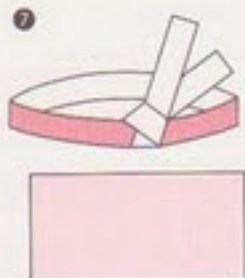

本体を差しこむ
すると「あ」は安定する

▶A◀ひとつ結び

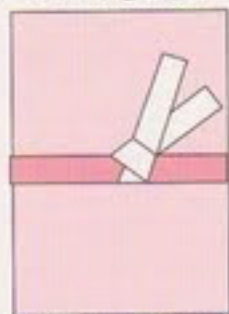

結び目の端は好みの長さ
に切るとよい

五角結び・相結び (B)、 上下結び (C)

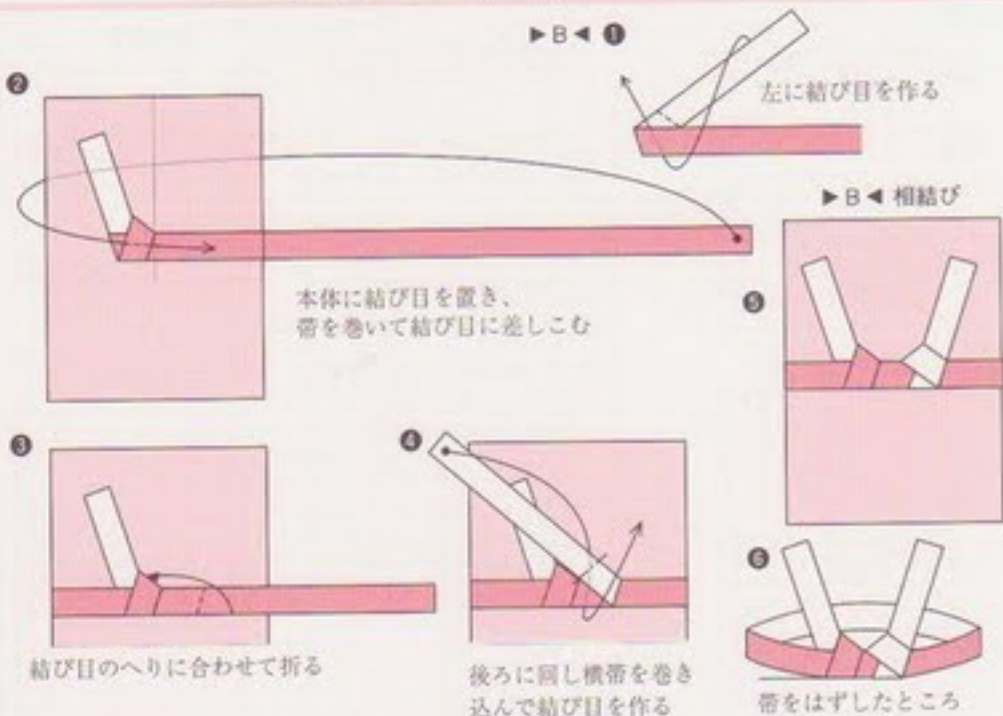

布施野
1951年
長野
きめど
1994年
1996年
2002年
2003年

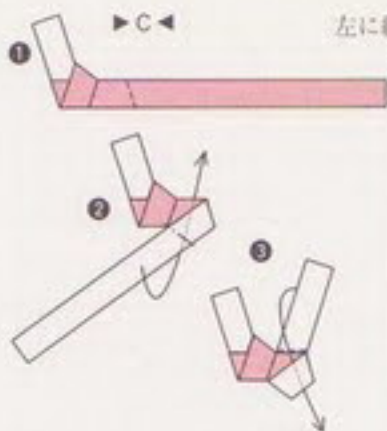

左に結び目を作る

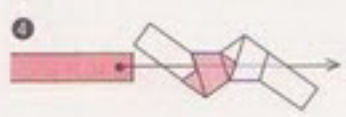
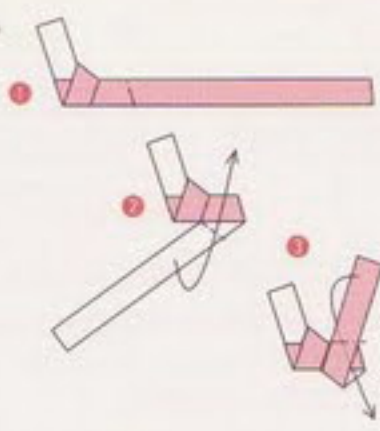

適当な長さの紙帯を差しこむ

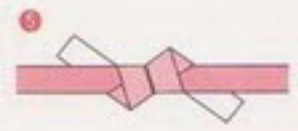
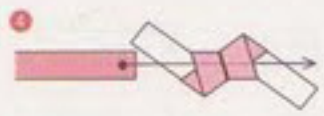

反対側を
表にしてもよい

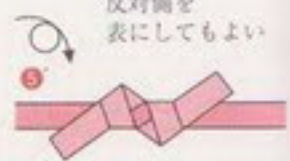

12
適紙帯はのり付けして輪にする

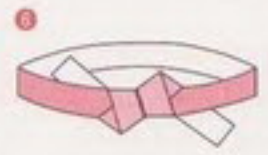

▶C◀ 紅白上下

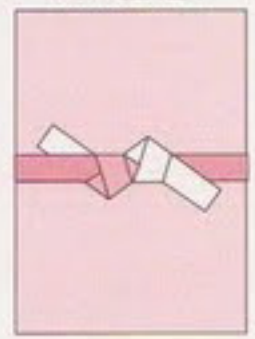

▶C◀ 上下

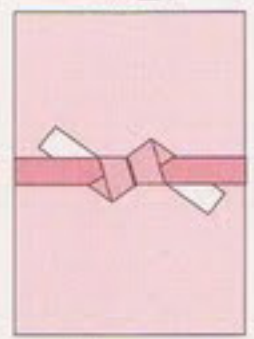

▶C◀ 裏上下

