

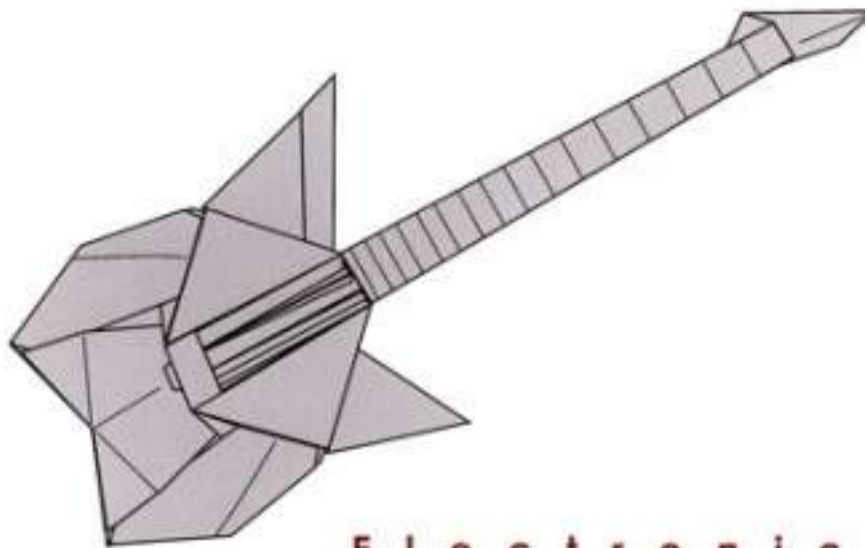

2008년 종이접기 컨벤션북



E l e c t r o n i c
G u i t a r



2008년 종이접기 컨벤션북

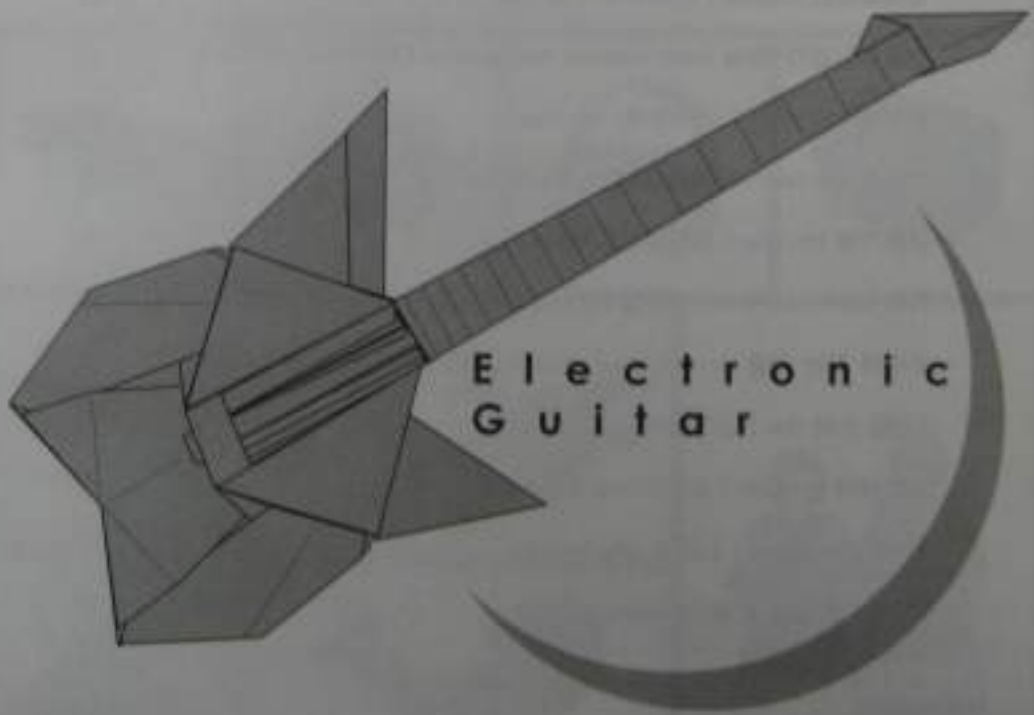

Electronic
Guitar

2008 한국종이접기컨벤션 창작작품 모음집

국내작품 Models of Korean

헤라클레스 장수풍뎅이 Hercules giant beetle 박대영 Park, Dae-Young	4
꽃받침이 있는 장미꽃 Rose with calyx 신한교 Shin, Han-Gyo	8
핸드백 Handbag 신한교 Shin, Han-Gyo	13
2인용 소파 Double sofa 신한교-변형 Shin, Han-Gyo, variation	18
마우스 랫츠 Mouse rats 정홍근 Jung, Hong-Keun	20
일렉기타 Electronic guitar 정홍근 Jung, Hong-Keun	24
알바트로스 Albatross 이재구 Lee, Jae-Goo	38
전통의상접기-원삼 Korean traditional dress-Wonsam 오규석 Oh, Kyu-Seok	42

전통의상접기-원삼	Korean traditional dress-Wonsam 오규석 Oh, Kyu-Seok	42
풍뎅이	Gold beetle 오규석 Oh, Kyu-Seok	46
구미호	Nine tailed fox 노혁균 Roh, Hyeuk-Kyun	50
공룡기병	Dino rider 노혁균 Roh, Hyeuk-Kyun	56
이륙	Leave the ground 이인섭 Lee, In-Seop	64
추위에 떠는 사람	Man who shiver with cold 김승균 Kim, Seung-Gyun	76
1인용 소파	Sota 김민경 Kim, Min-Gyeong	79
하트상자	Heart box 최영주 Choi, Young-Ju	80
전투기	Aero fighter 장은수 Jang, Eun-Soo	82
쥐	Rat 조성범 Jo, Seong-Beom	84

표지 작품 : 일렉기타 - 정홍근
전표지 작품 : 공룡기차 - 노혁균

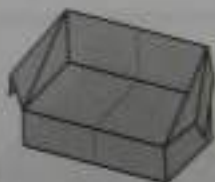
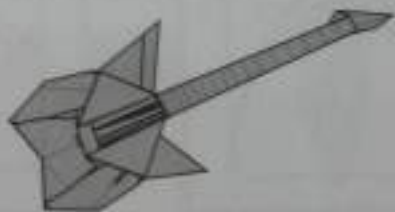

헤라클레스 장수 풍덩이



- 작가 : 박 대 영
- 종이 : 양면색종이
- 종이 크기 : 15cm × 15cm
- 완성후 크기 : 7cm × 7cm

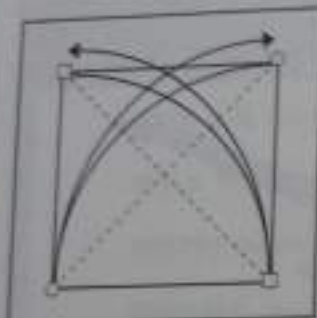

1. 육각으로 접기선을 만드세요.

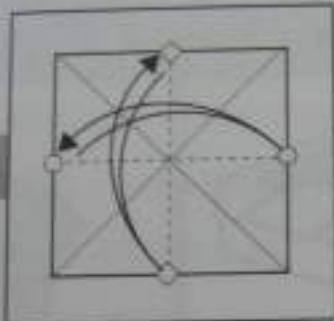

2. 접기선을 만드세요.



3. 안쪽 부분을 접으세요.
(사각형으로 접기)

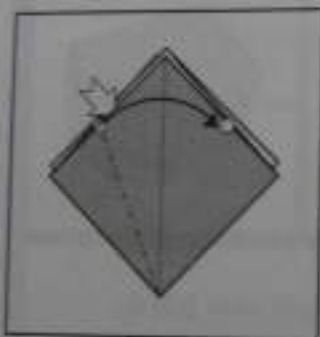

4. 안쪽 부분을 접으세요.

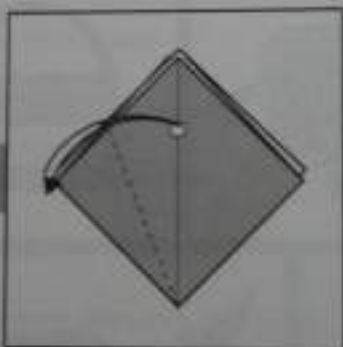

5. 중심선을 맞춰 접기선을 만드세요.

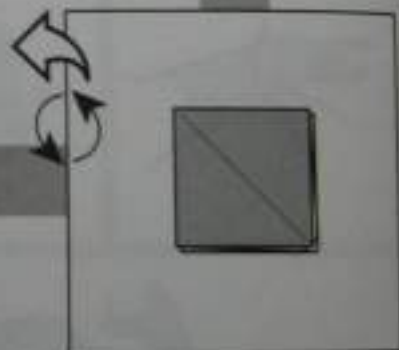

6. 135도 회전

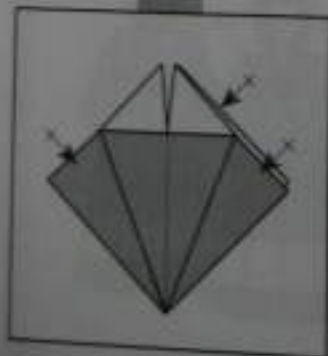

7. 작은 20정도 같은 각도로 접으세요.

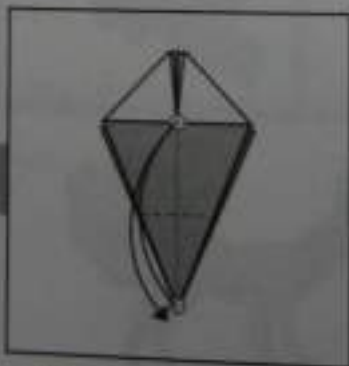

8. 점과 점을 맞춰 접이 접기선을 만드세요.

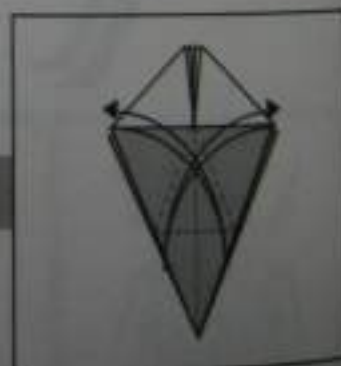

9. 접기선을 만드세요.



10. 선을 따라 접으세요.

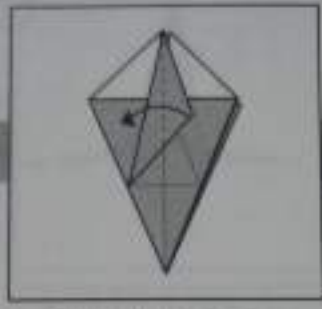

11. 중심선에 맞춰 접으세요.

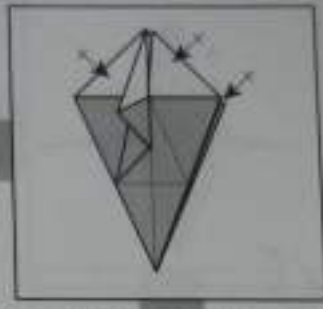

12. 다른 3곳도 같은 방법(10-11)으로 접으세요.



15. 다른 3곳도 같이 안으로 넣어 접으세요.

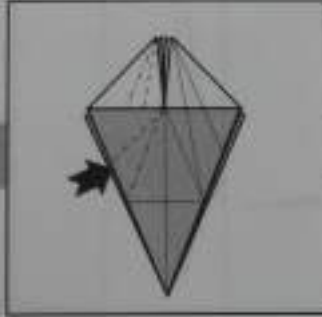

14. 선을 따라 안으로 넣어 접으세요.

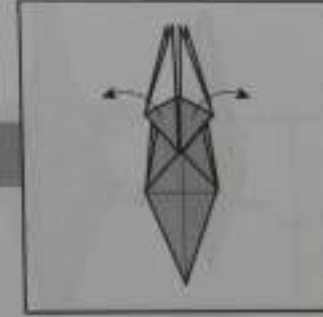

13. 10번 모양이 되도록 모두 펼치세요.

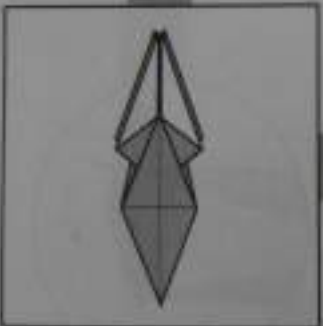

16.

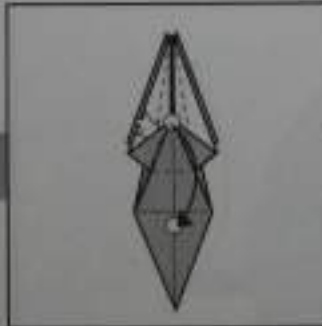

17. 점과 점을 맞춰 맞춰 눌러 접으세요.

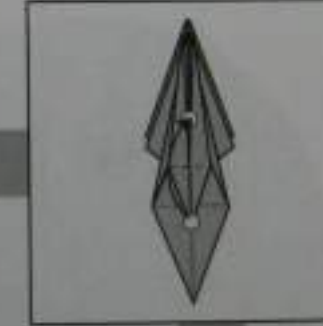

18. 점과 점을 맞춰 위로 접어 눌러주세요.

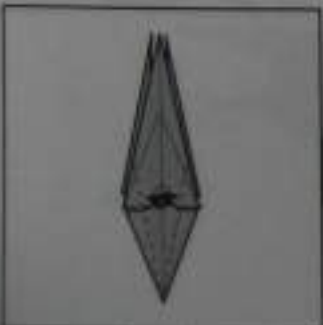

22. 밑의 모서리를 중심선에 맞춰 접으세요.

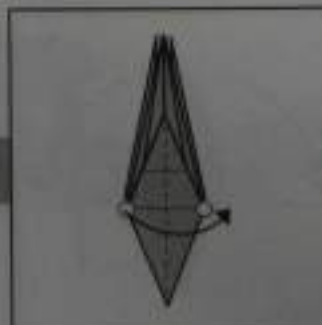

20. 위의 한갈만 점과 점을 맞춰 안으로 접으세요.

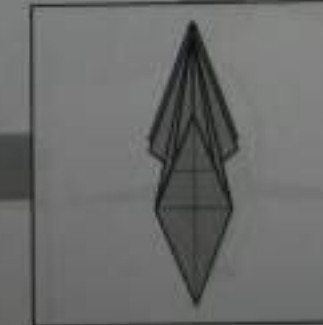

19. 다른 3곳도 같은 방법(17-18)으로 접으세요.



22. 선을 따라서 제단집기 하세요.

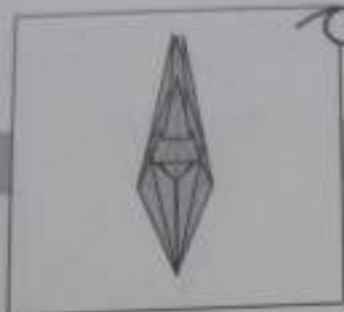

23. 뒤집으세요.

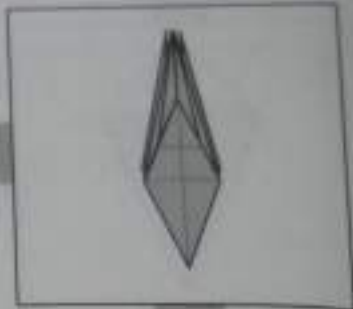

24. 같은 방법(20-21)으로
집으세요.

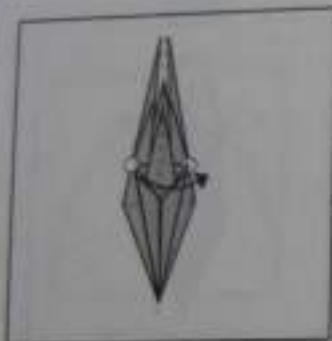

25. 점과 점을 맞춰 반
집으세요.

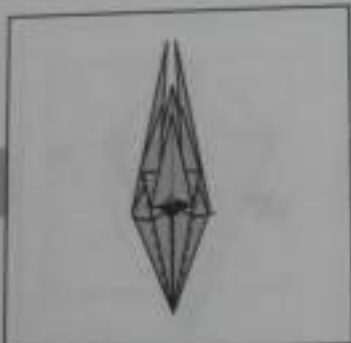

26. 선을 따라 중심선에 맞춰
집으세요.

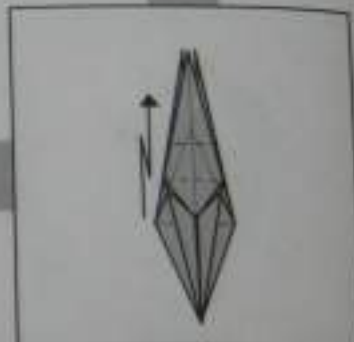

27. 선을 따라서 제단집기 하세요.

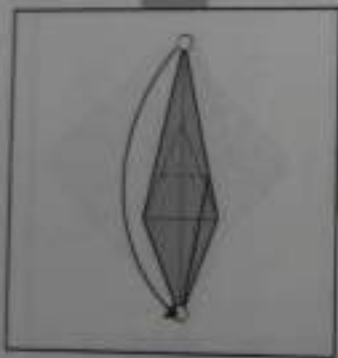

28. 점과 점을 맞춰
내려 집으세요.

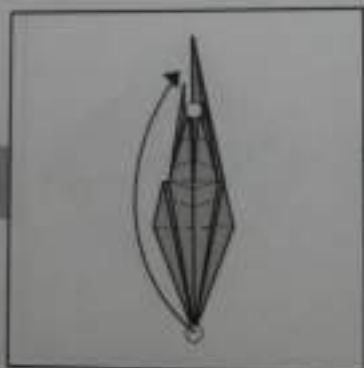

29. 점과 점을 맞춰
올려 집으세요.

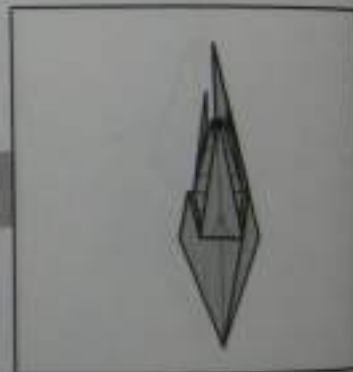

30. 반대쪽도 같은 방법(25-27)
으로 집으세요.

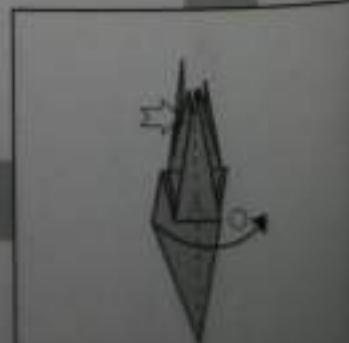
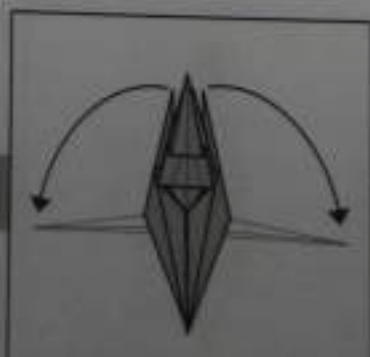

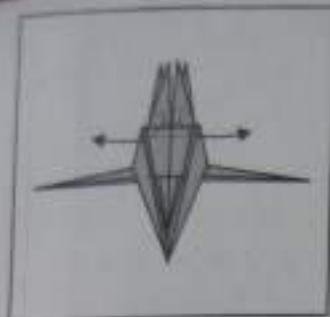

32. 양옆으로 접어 넣으세요.

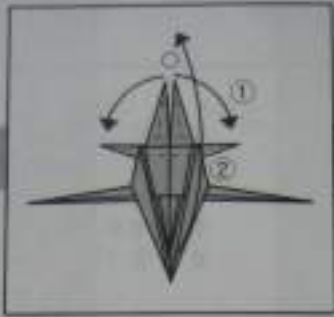

33. 순서에 맞춰 접으세요.

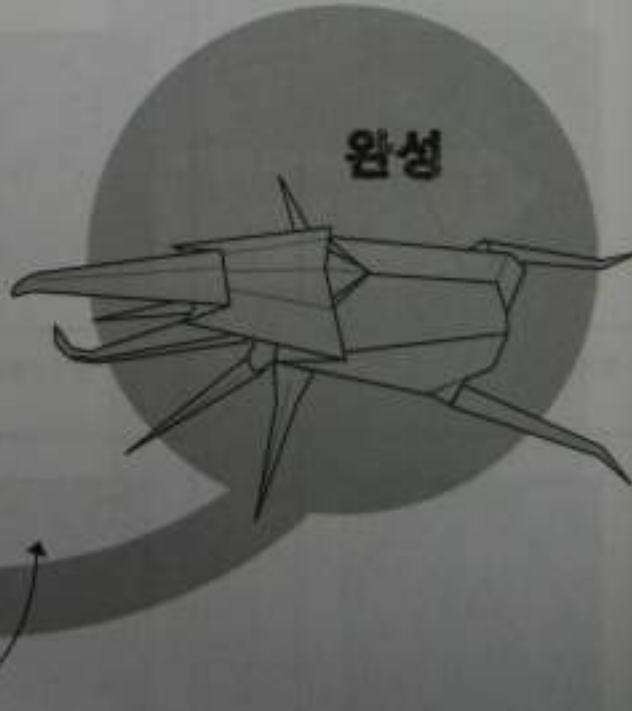
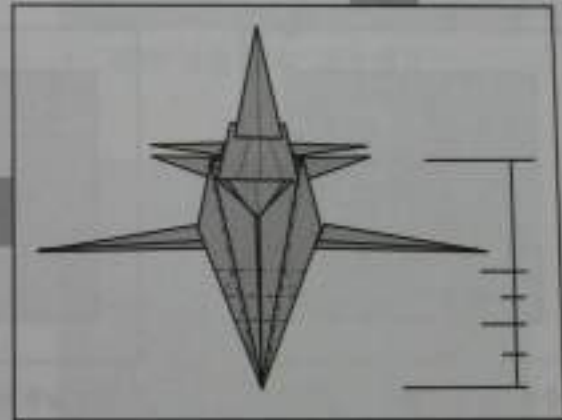
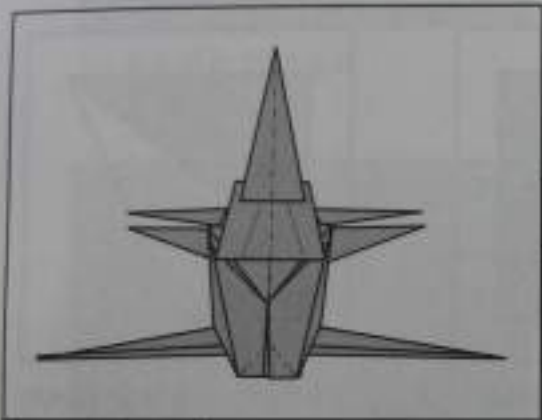

완성

꽃받침이 있는 장미



- ①창작 : 신한교
- ②종이 : 양면색종이
- ③종이크기 : 15cm × 15cm
- ④완성후 크기 : 6cm × 6cm
- ⑤작업 TIP : 종이 선택시 초록과 빨강이 있는 양면 색종이가 좋다.

5등분하는 방법

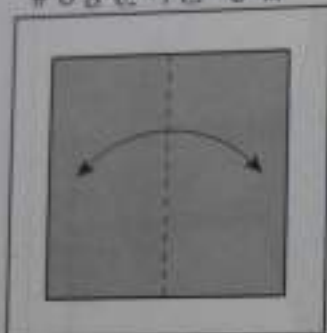

1. 중심선을 만드세요.

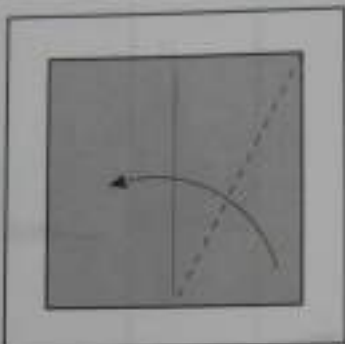

2. 선에 맞춰 비스듬히 접으세요.

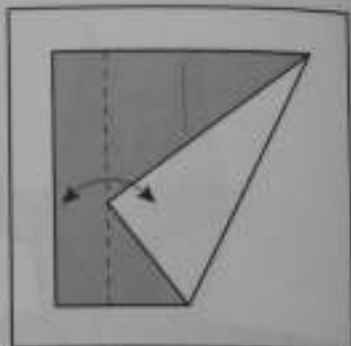

3. 꼭지점이 만나는 곳을 접으세요.

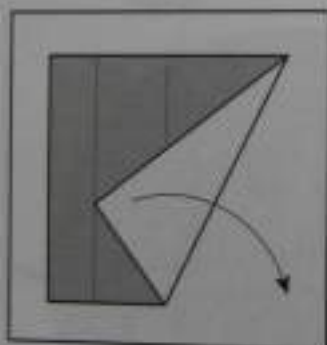

4. 펼치세요.

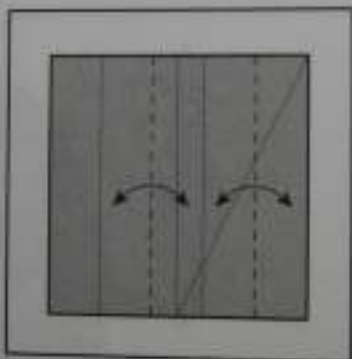

5. 한번의 길이 5등분하세요.

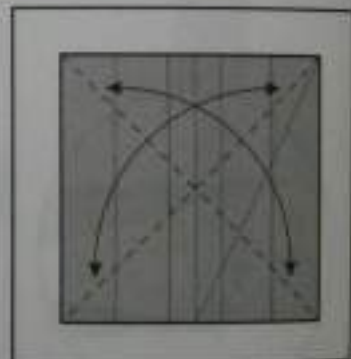

6. 대각선으로 접으세요.

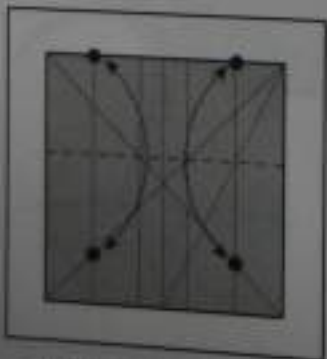

7. 점과 점을 맞춰 접고
5 × 5등분하세요.

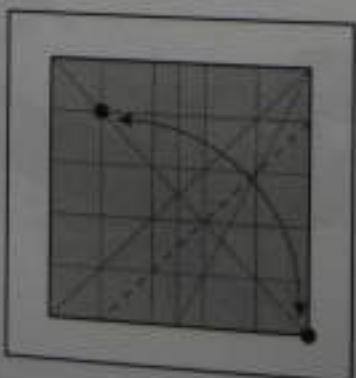

8. 점과 점을 맞춰 접고
10 × 10등분하세요.

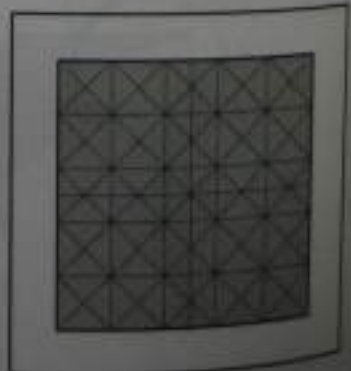

9. 여기서 시작합니다.

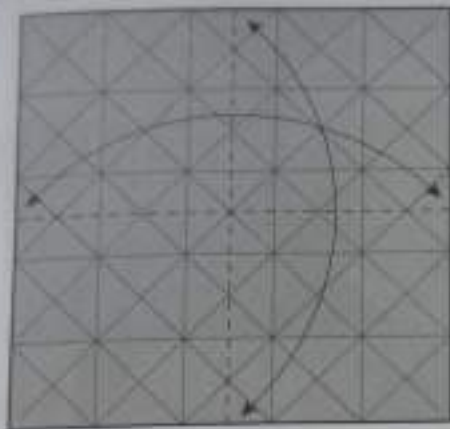

10. 중심선을 만드세요.

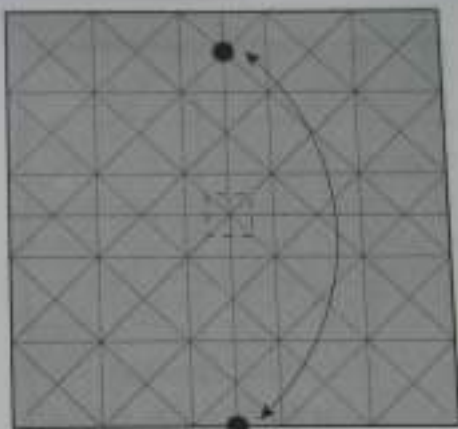

11. 점과 점을 맞춰 접으세요.

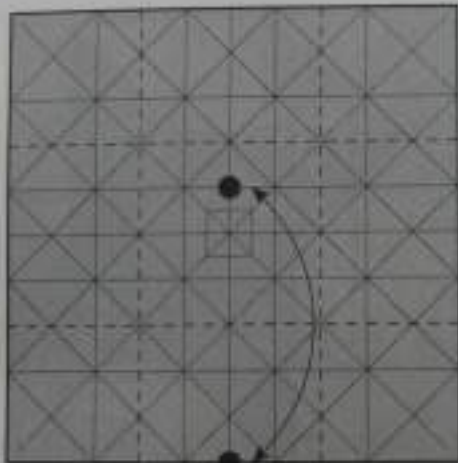

12. 점과 점을 맞춰 접으세요.

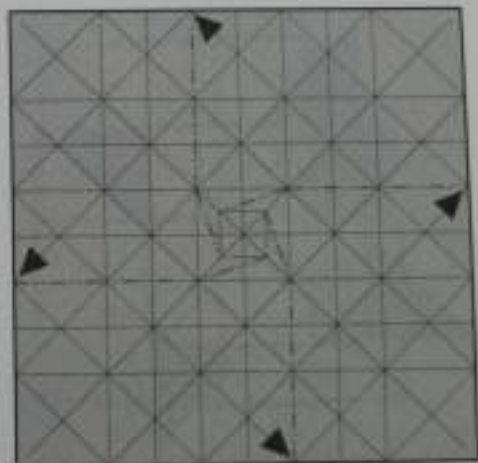

13. 그림처럼 산선을 만드세요.

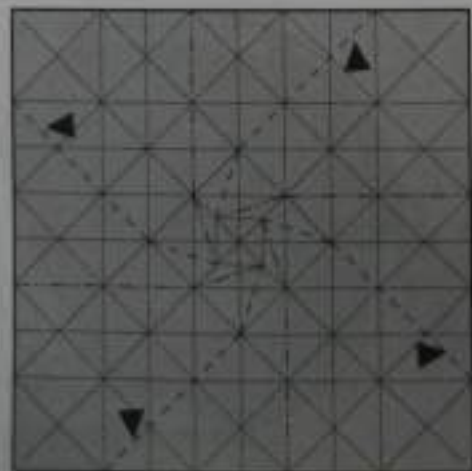

14. 그림처럼 계곡선을 만드세요.

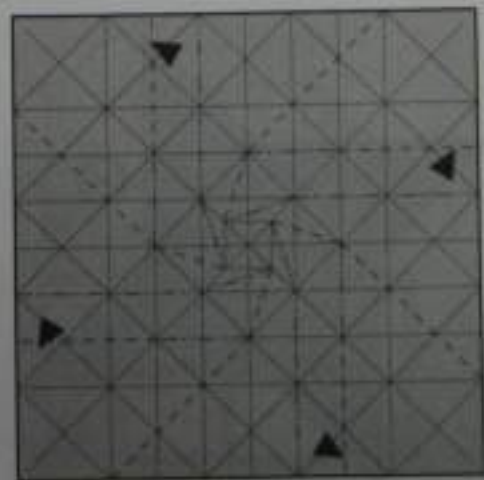

15. 그림처럼 산선을 만들고,

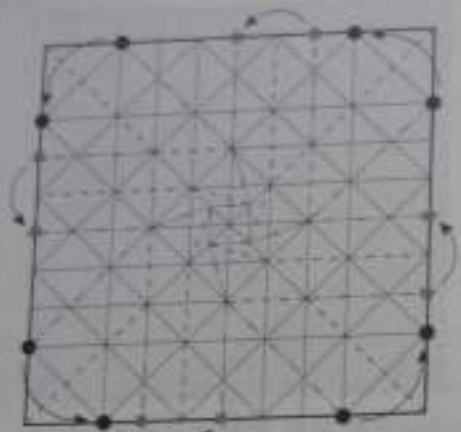

16. 선을 따라 점과 점을 맞춰 접으세요.

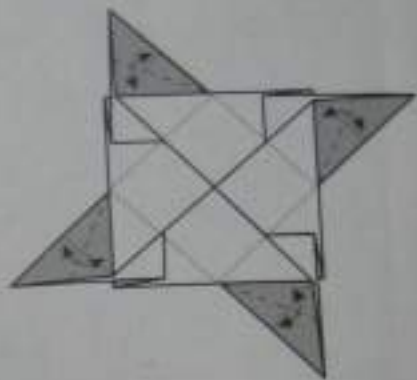

17. 접기선을 만드세요.

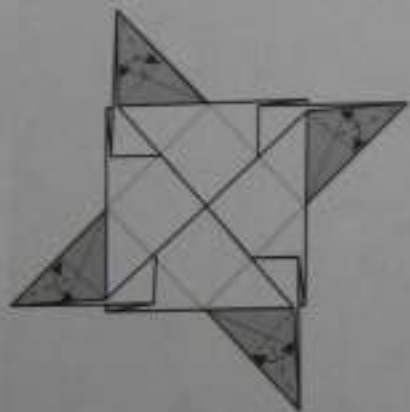

18. 접기선을 만들고 뒤집으세요.

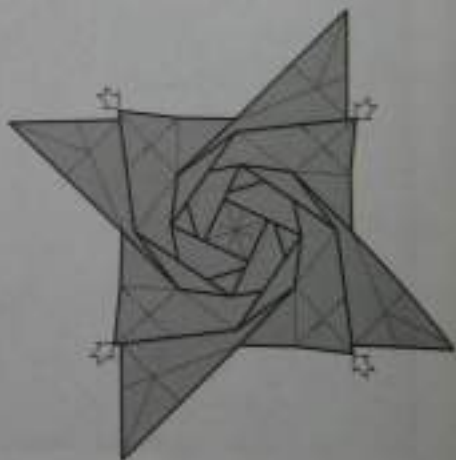

19. 선을 따라 화살표방향으로 안으로 넣어 접으세요.

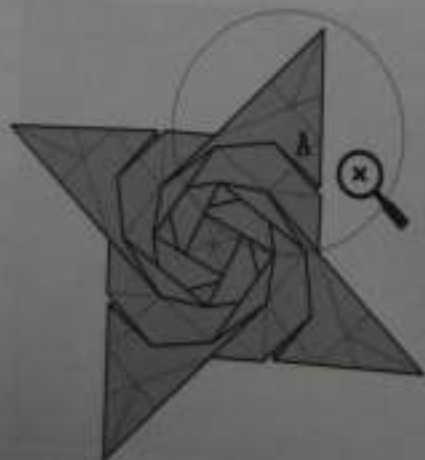

20. 부분 확대

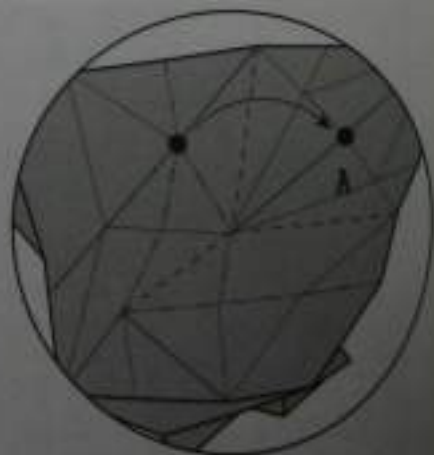

21. 선을 잡고 점과 점



22. 뒤집으세요.



23. 점과 점을 맞춰 펼쳐눌러
접으세요.

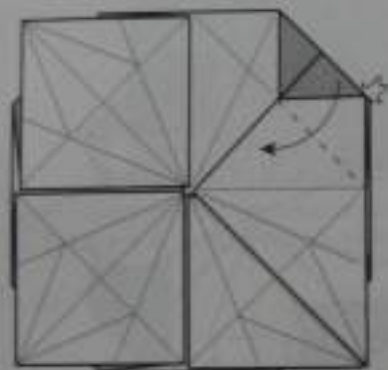

24. 선을 따라 펼쳐눌러 접으세요.

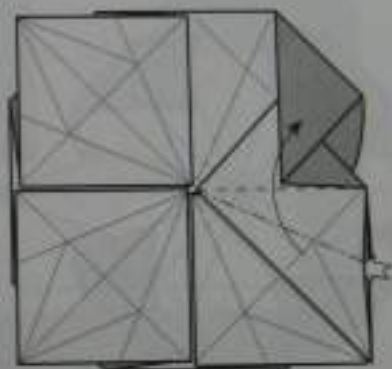

25. 선을 따라 펼쳐눌러 접으세요.

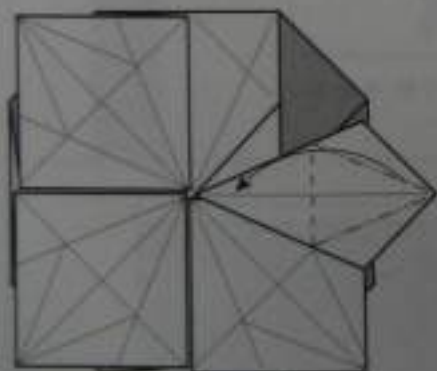

26. 펼쳐눌러 접으세요.

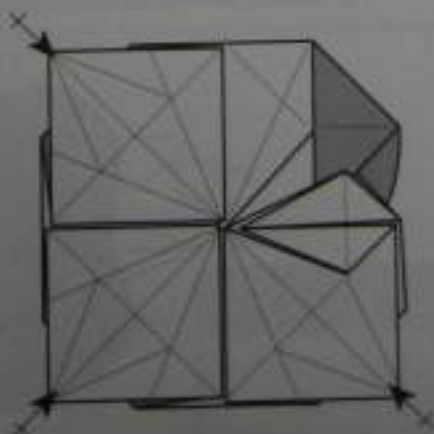

27. 다른 3곳 같은방법으로
접으세요. (23~26)



28.그림처럼 비스듬히 접으세요.



29.밖으로 접으세요.

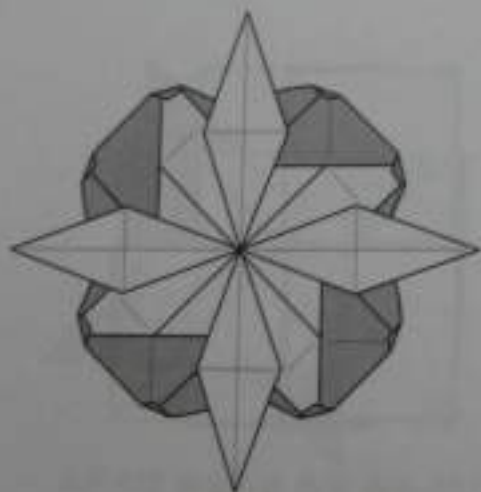

30.뒤집으세요.

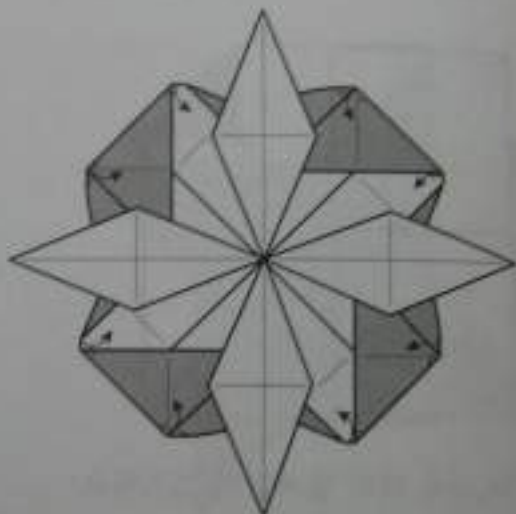

31.모서리를 조금 접으세요.

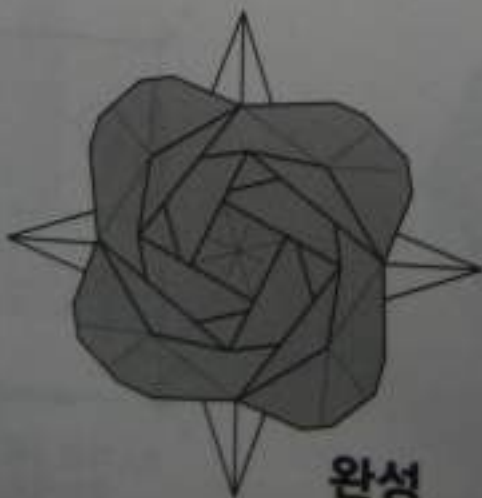

완성

핸드백



- ①장작 : 신탄교
- ②종이 : 양면포장지
- ③종이크기 : (가방) 75cm × 37.5cm
(손잡이) 50cm × 5cm
- ④완성후 크기 : 14cm × 4.8cm × 9.5cm
- ⑤작업 TIP : 속지를 넣어 사용합니다.



1. (16등분해서 사용)모서리의 1마디를 접어서 보냅니다.



2. ●과 ●을 맞춰 접으세요.



3. 뒤집으세요.

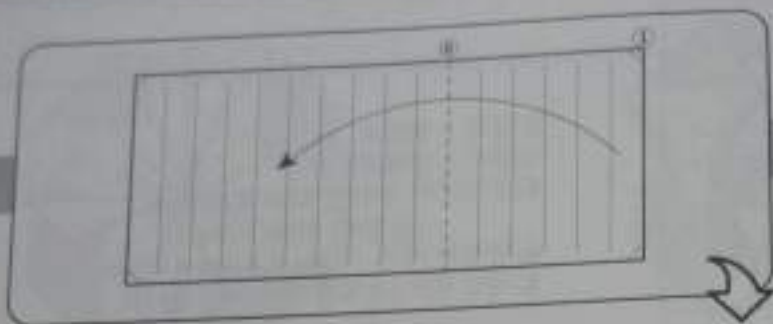

4. 2번을 선을 접으세요.

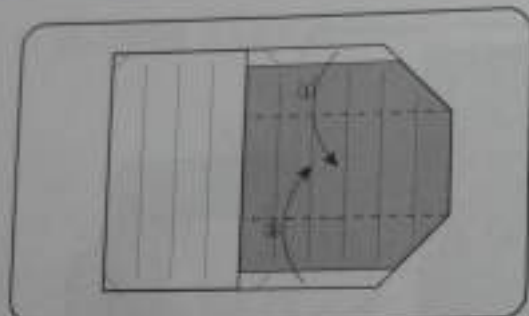

6. 양쪽 모퉁이를 접으세요.

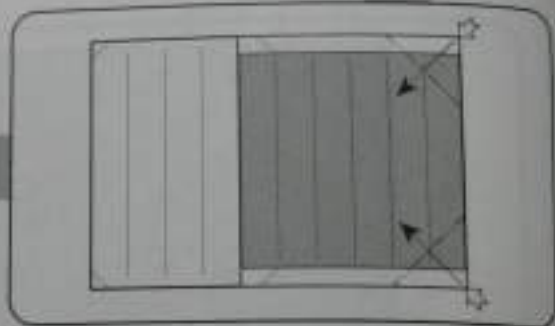

5. 양쪽 모퉁이를 안으로 접어 접으세요.

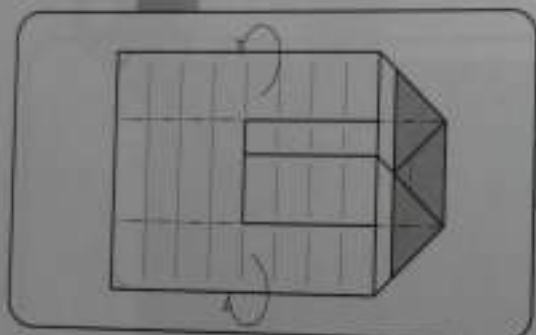

7. 접은 선을 따라 나란히 접으세요.

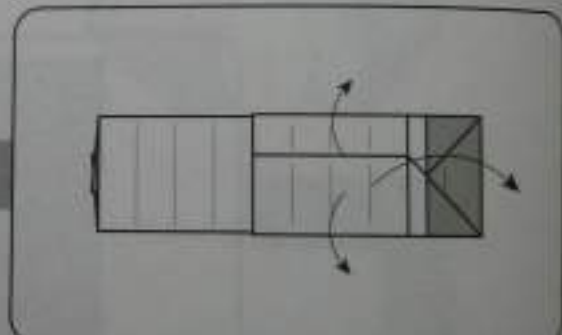

8. 4번 위치를 잘라주세요.

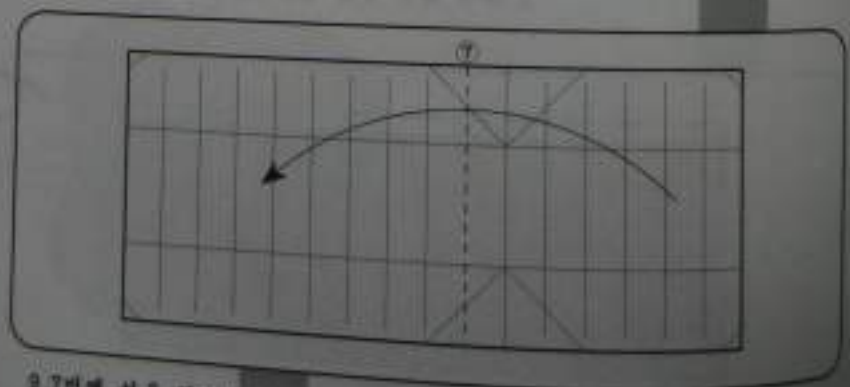

9. 7번에 선을 접으세요.

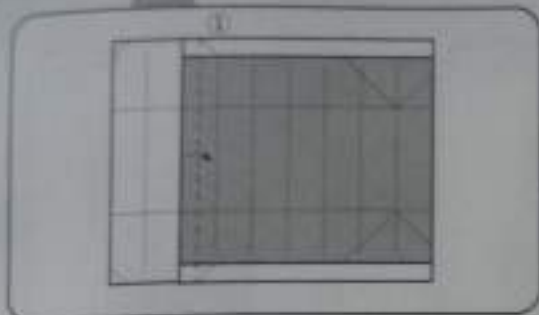

10. 1번쪽선을 맞춰 접으세요.

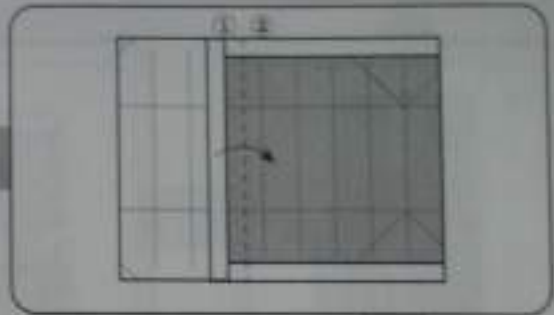

11. 1번쪽과 2번쪽 사이로 접으세요.

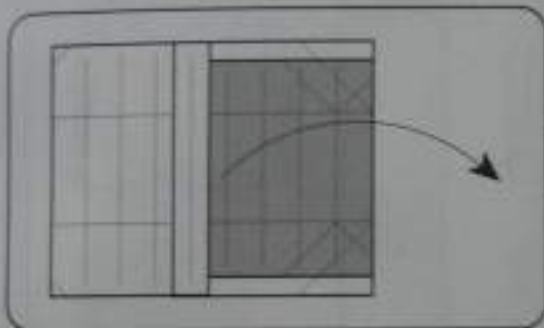

12. 펼치세요.

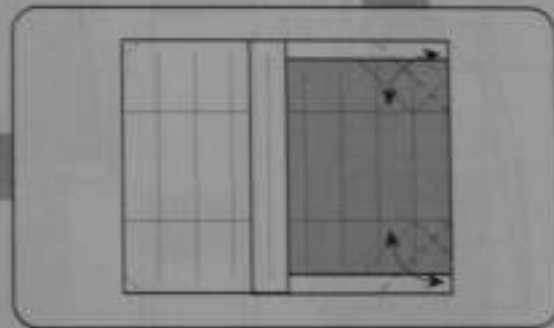

13. 양쪽 2마디를 접어 한가운데를 만드세요.

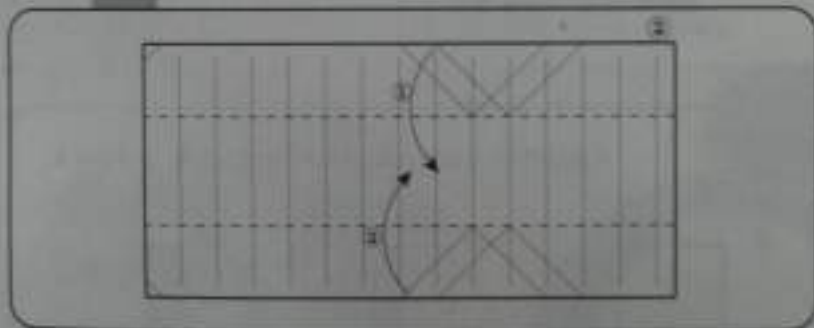

14. 선을 따라 접으세요.

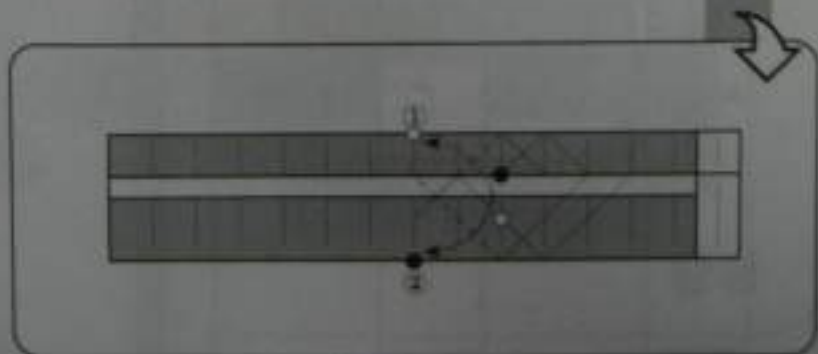

15. ●과 ●을 맞춰 접으세요.



16. ●과 ●을 맞춰 잡으세요.



17. 90° 자와 되도록
정각의 각을 맞추세요.



18. 순서대로 맞춰 잡으세요.

샌드백 손잡이

* 손잡이간 거리와 크기로 손잡이 두 개를 만들어주세요.



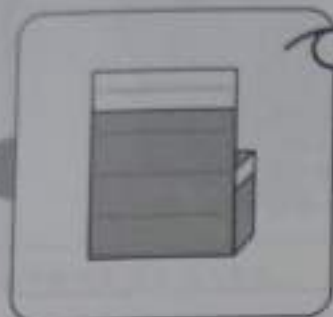

19. 뒤집으세요.

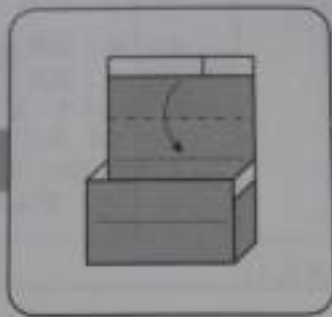

20. 뒷장의 한마디를 내려
접으세요.



21. A축으로 B를 끼워 넣어
잘리지 않도록 하세요.

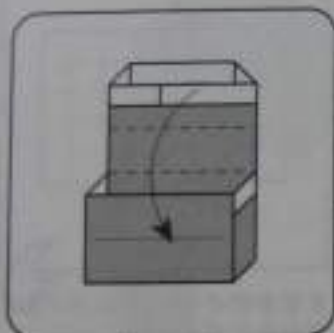

22. A축으로 B를 끼워 넣어
잘리지 않도록 하세요.

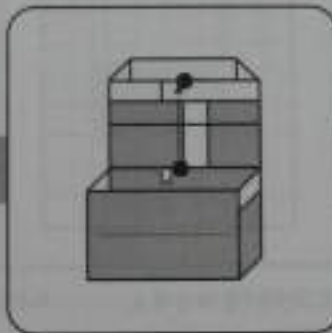

23. ●와 ●을 맞춰 뒷장을
뒷장의 안으로 접으세요.

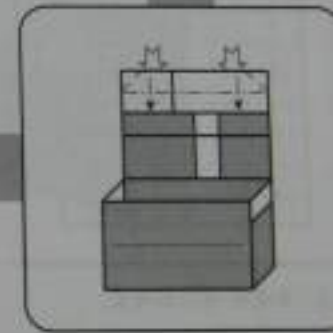

24. 선으로 따라서 안으로
넣어 접기를 하세요.

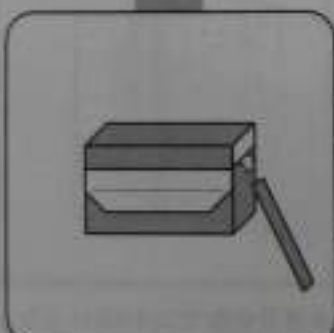

25. 손잡이부분을 확실히 안으로
넣어 접기를 하세요.



완성

2인용 의자



- 변형 : 인한교
- 종이 : 소포지
- 종이 크기 : 91cm × 146.5cm
- 완성후 크기 : 36cm × 18cm × 23cm
- 작업 TIP : 정사각형 종이를 정육각형 종이로 만들기.

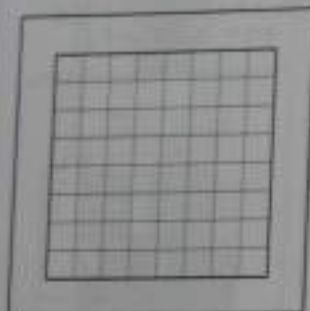

1. 8×8에서 시작하세요.

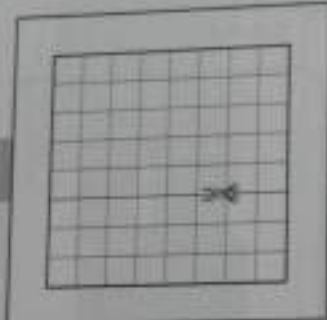

2. 3판을 잘라내세요.

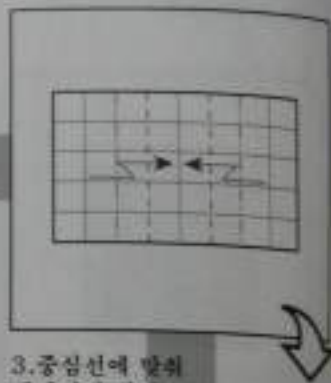

3. 중심선에 맞춰
계단접기 하세요.

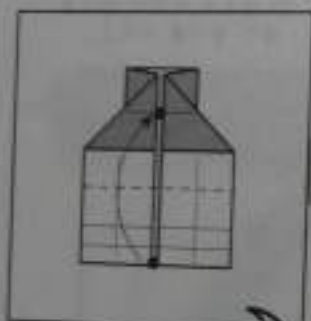

4. 겹과 겹을 맞춰 접으세요.

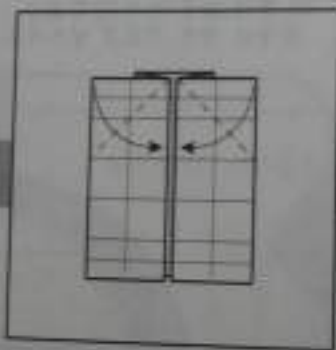

5. 중심에 맞춰 모서리를
접으세요.

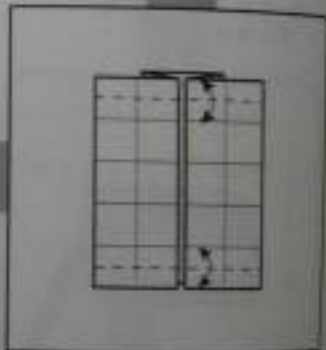

6. 겹기선을 만드세요.

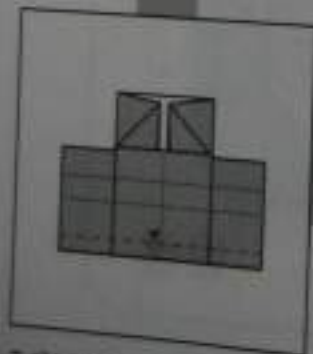

7. 약 1/4 정도를 접으세요.

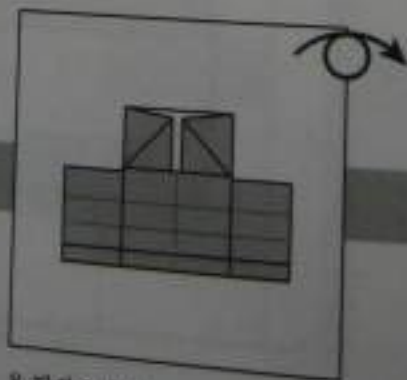

8. 뒤집으세요.

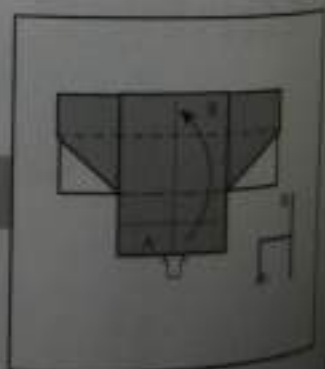

9. H모양이 되도록 접으세요.

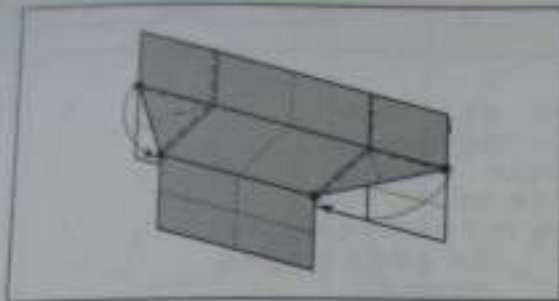

10. 접과 접을 맞춰 접으세요.

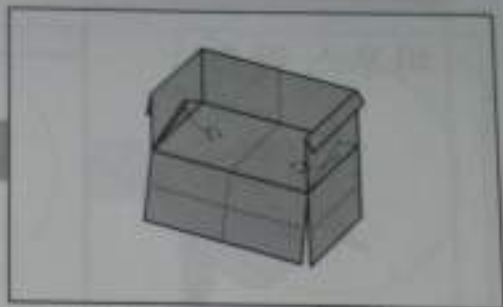

11. 삼각형을 밑으로 기워 넣으세요.

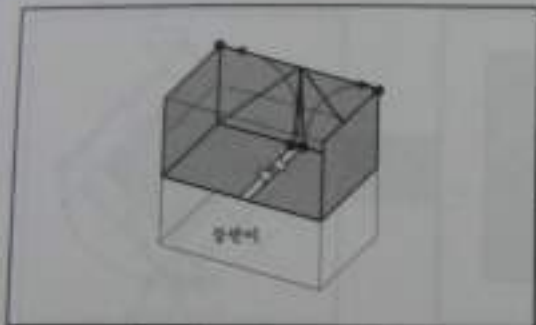

13. 바닥의 종이판 키네 접과 접을 맞춰 접으세요.

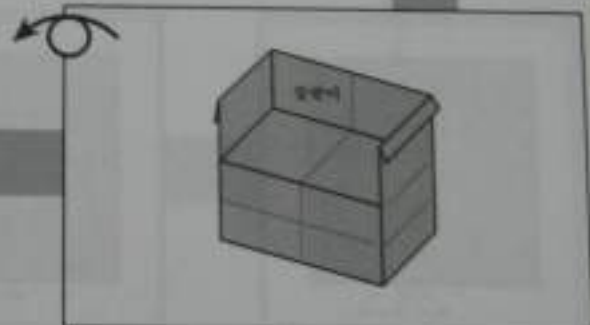

12. 뒤집으세요.

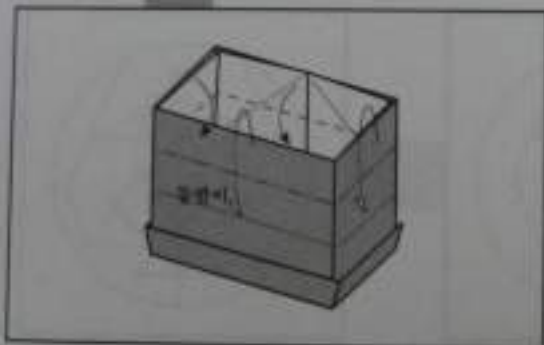

14. 선을 따라 안으로 넣어 접으세요.

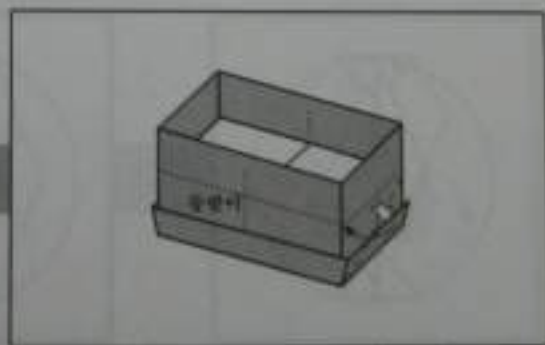

15. 선을 따라 펼쳐 접으세요.

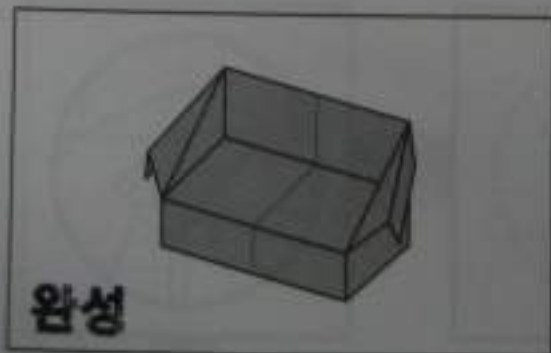

완성

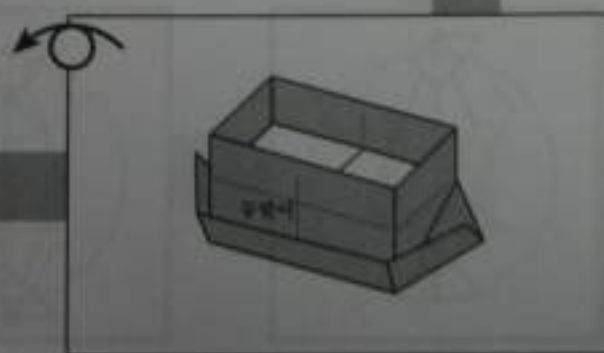

16. 뒤집으세요.

마우스 랫츠



- ①작가 : 정홍근
- ②종이 : 양면색종이
- ③종이 크기 : 15cm × 15cm
- ④완성후 크기 : 7cm × 7cm
- ⑤작업 TIP : 입체모양에 주의 하세요.
특히 뺨부분은 볼펜끝으로 정리해주세요.

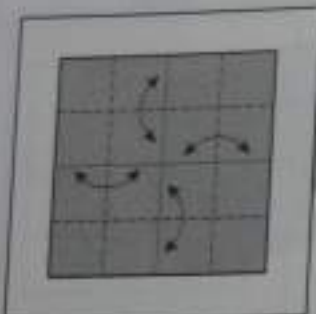

1. 접었다 펴서 접기선을
만드세요.

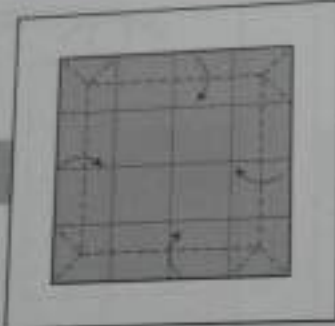

2. 접기선을 따라 썬베접기
화듯이 접으세요.

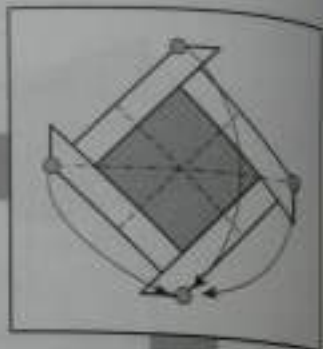

3. 점과 점이 평다오본
접으세요. (사각주머니 접기)

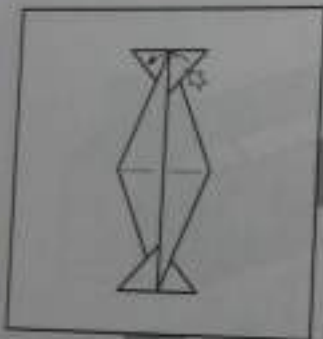

4. 평처늘려 접으세요.

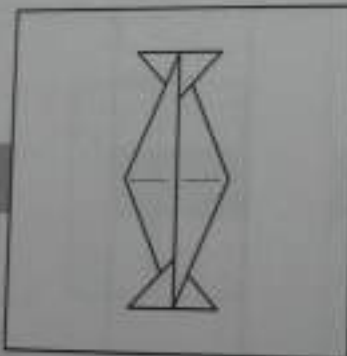

5. 학접기 끝 모서리의 배치를
그림과 같은 모양으로 만든다.

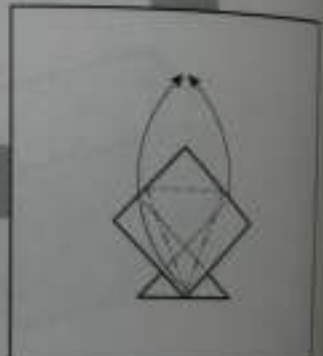

6. 선을 따라 올려접으세요.
(학기본형접기)

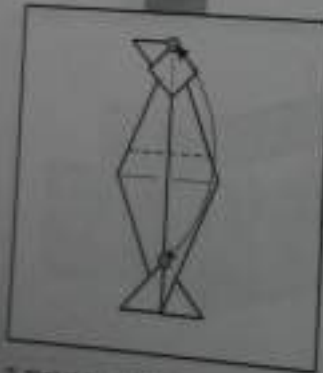

7. 접기선을 만드세요.



8. 접기선을 만드세요.



9. 접기선을 만드세요.



10. 좌편을 정중선으로 접으세요.



11. 상단으로부터 밑쪽 뒤집어 접으세요.



12. 뒤집어 접은 모양.



15. 부분확대.

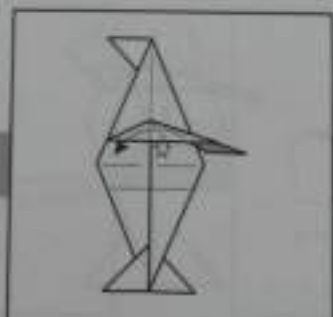

14. 밑쪽부터 접으세요.

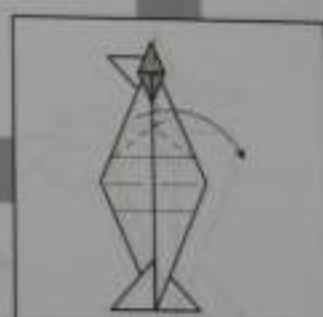

13. 선을 따라 밑으로 접으세요.



16. 밑선에 맞춰 선을 따라 접으세요.



17. 부분확대.

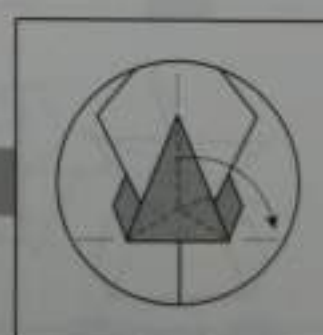

18. 선을 따라서 접으세요.

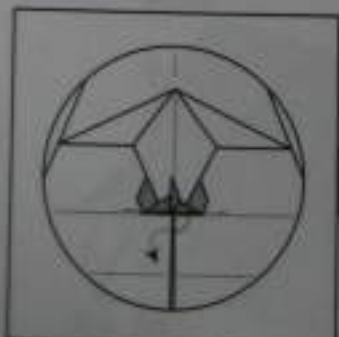

21. 갈라진 틈으로 끼우세요.

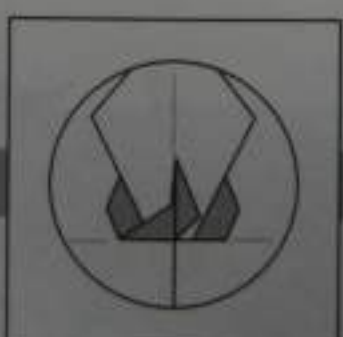

20.



19. 뒤집어 접으세요.

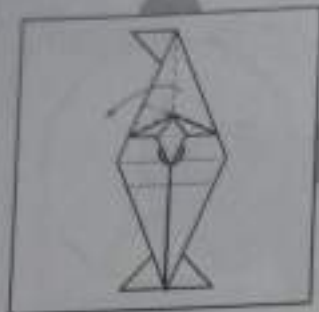

22. 선을 따라 접으세요.

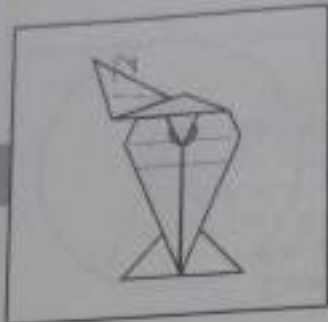

23. 위로 접으세요.



24. 밑에 접으세요.



27. 위로 올려주세요.

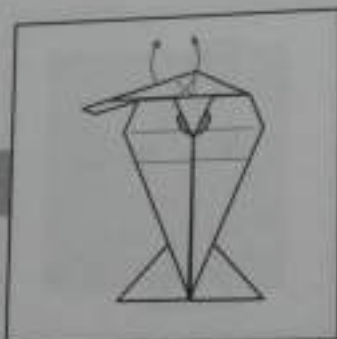

26. 뒤집어 접으세요.



25. 위로 접으세요.

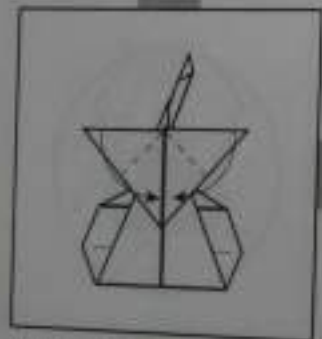

28. 선을 따라 접으세요.

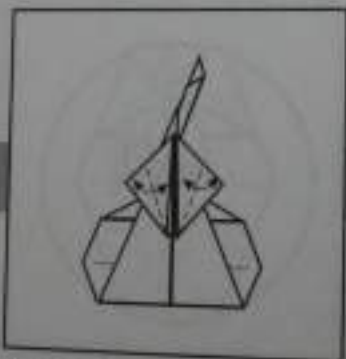

29. 절기선을 만드세요.

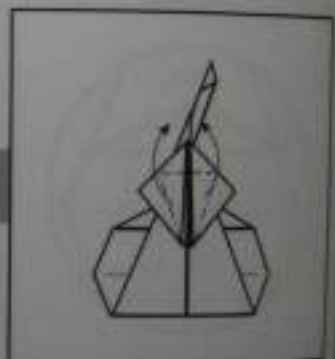

30. 선을 따라 위로 올려
접으세요.

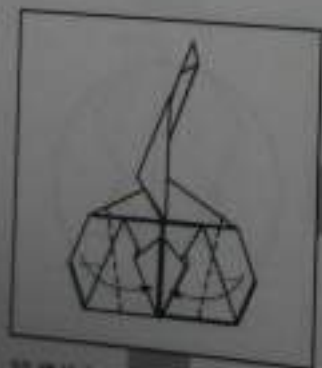

31. 절선이 닿을 때까지
접으세요.



32. 위로 접으세요.



33. 위로 접으세요.

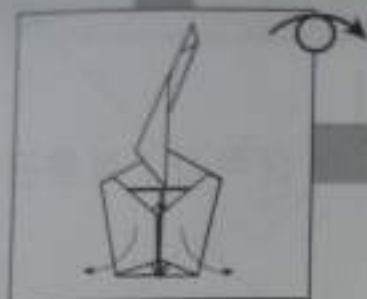

34. 펼쳐서 90도로 세우세요.



35. 뒷모습

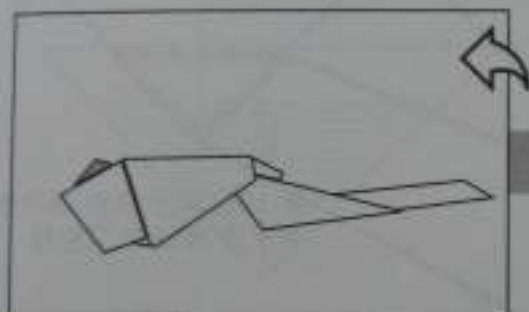

41. 뒷모습

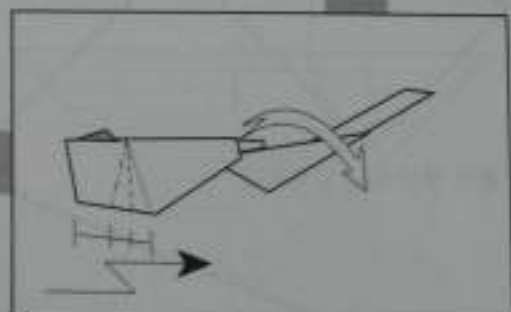

40. 옆선을 기준으로 계단접기하세요.

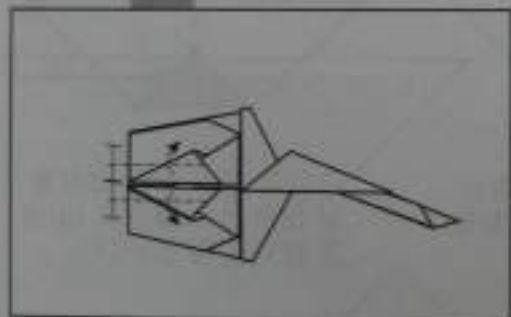

42. 선을 따라 펼쳐 접으세요.

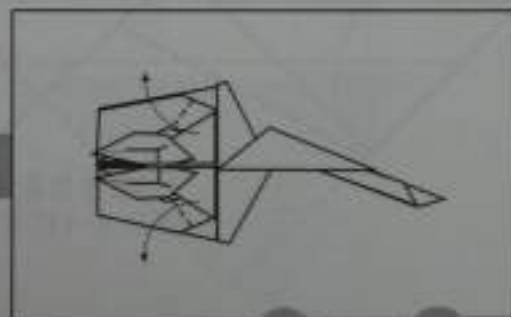

43. 선을 따라 접어 다리를 세우세요.



완성

일렉기타 접기

창작자 : 정홍근

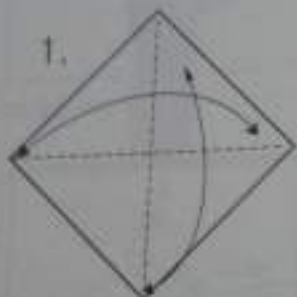

종이 겹면에서 시작한다.

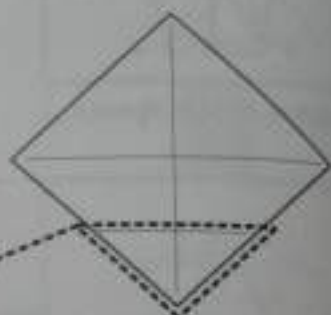
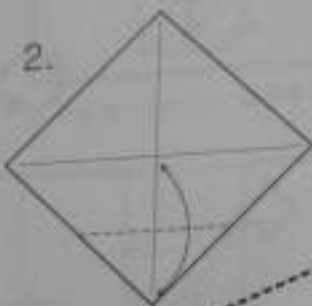

3-10단계는 작은 삼각형 부분만 확대한 그림임

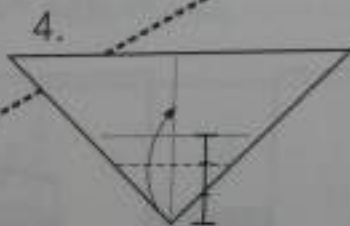
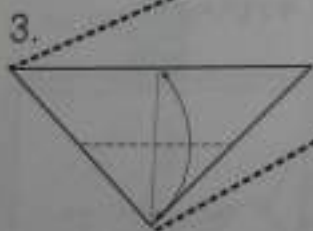

2/3등분점을 접는다. 접는 법은 4-1단계 그림을 참조

4-1.



그림과 같이 작은 삼각형의 대각선의 중심이 (a)선과 만나도록 접는다.

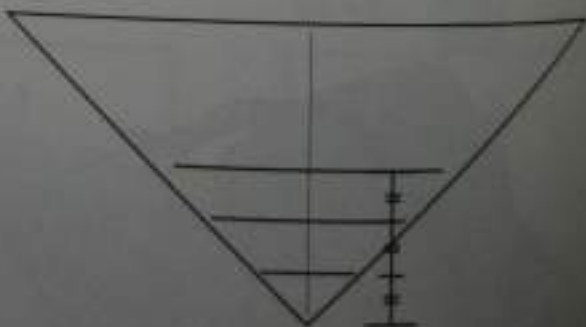
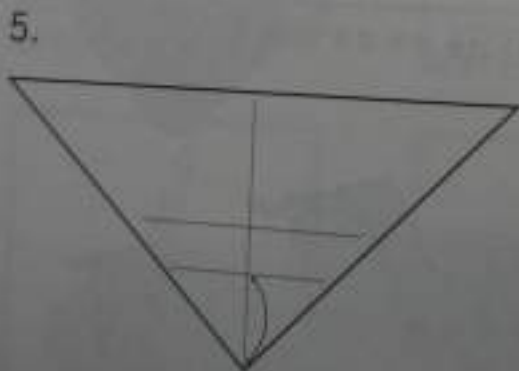

3등분 완성

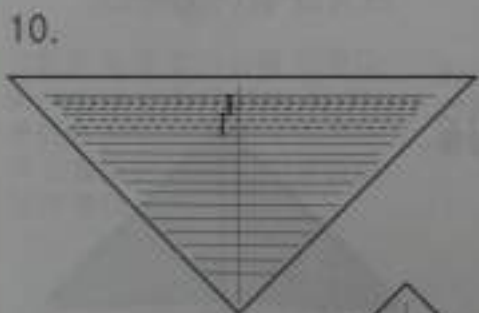
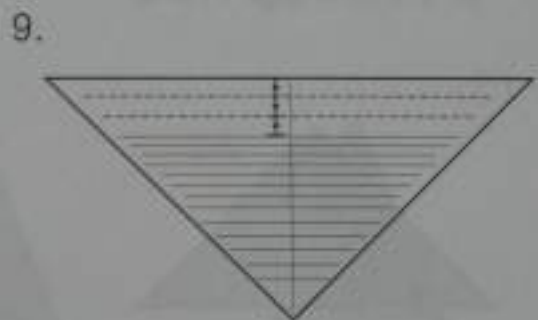
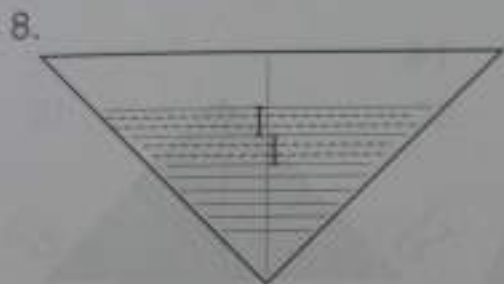
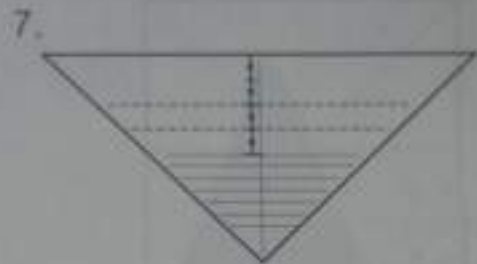
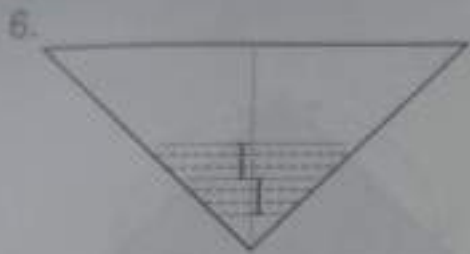

기타 넥 지판 완성

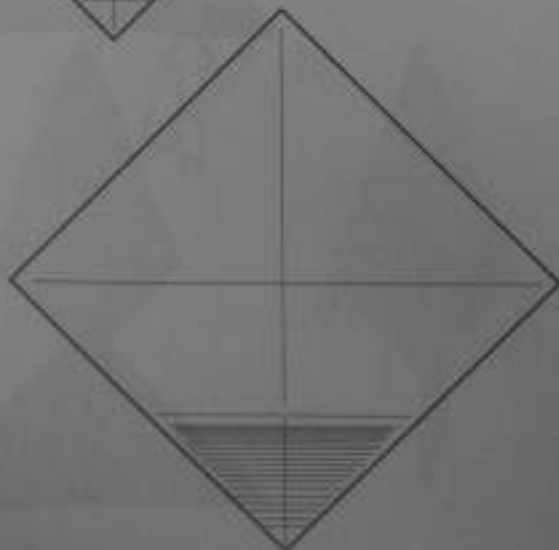

종이 한 귀퉁이에 접기선을 내어주
어 기타의 지판을 완성하였다. 다
을 단계부터는 이렇게 접기선이 그
어진 정사각형 종이로 시작한다.
편의상 지금 단계까지 만들어진 접
기선들은 다음 단계부터 생략한다.

11.

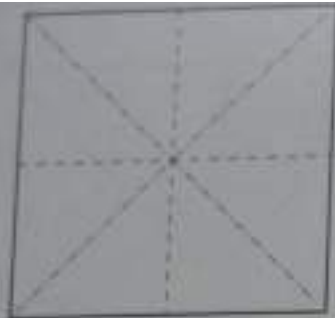

삼각주머니접기 기본형

12.



13.



14.

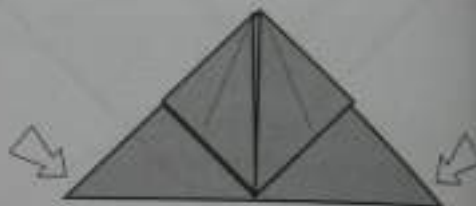

남은 두 부분도 12-13 단계와 같이 접는다.

15.



다시 삼각주머니접기 기본형으로 펼친다.

16.

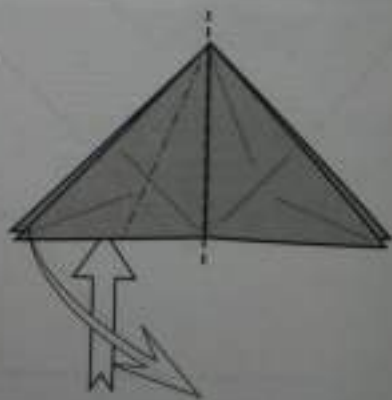

17.



18.



19.



이 단계 부분도 16-18 단계와 같이 접는다.

20.



이 단계 부분도 16-18 단계와 같이 접는다.

21.



그림과 같이 접기선을 만든다. 이 부분이 기타의 넥이 될 부분으로 3-10단계에서 접기선이 만들어진 부분이 이부분이 되어야 한다.

22.



21단계에서 만든 접기선들을 모두 이용하여 합쳐접기한다.

23.



24.



25.



26.



27.



28.

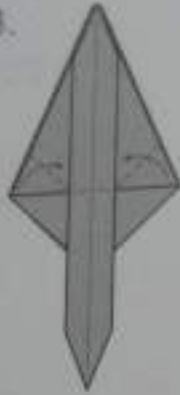

29.

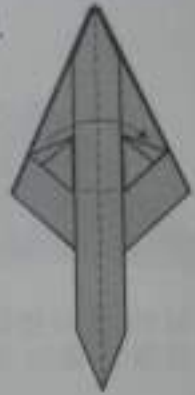

남은 한 부분도 24-26단계와 같이 접는다.

30.



31.



32.

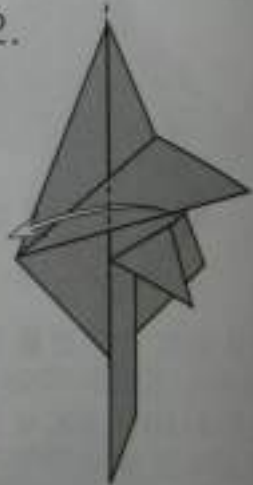

공간 선이 표시된 곳에 맞게 접는다.

33.



34.

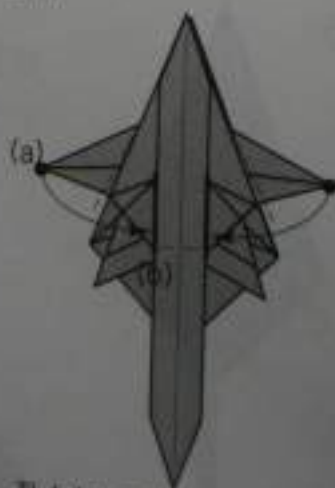

35.



남은 한 부분도 29-32단계와 같이 접는다.

점 (a)가 점선 (b)와 같은 선을 따라 접는다.

36.



37.



38.



39.

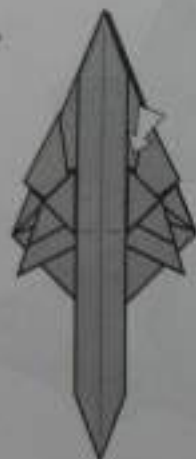

남은 한 부분도 36-38 단계와 같이 접기선을 만들어 준다.

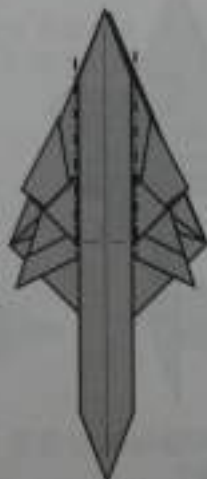

40.



화살표와 같이 가운데를 벌리면서 접는다.

36-39단계에서 만들어준 접기선은 후에 기타를 입체화 하는데 필요하다.

41.

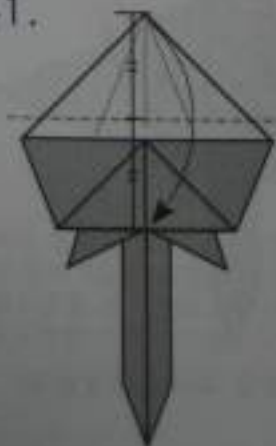

42.

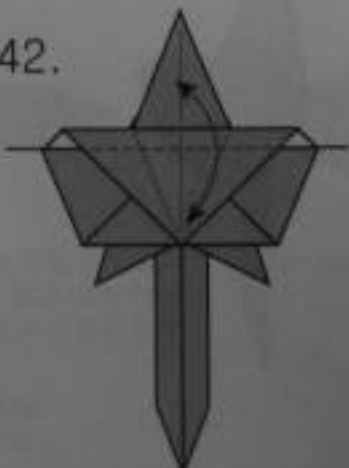

43.



44.



45.



그림과 같이 풍기선으로 기준
을 정하여 접는다.



중간 완성모습

46.

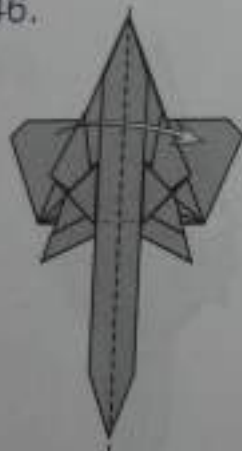

47.



그림과 같이 접어서 안으로
밀어 넣는다.

48.



49.



50.



51.



풍기선들 이용하여 기준
을 만들고 접는다.

[㉞]

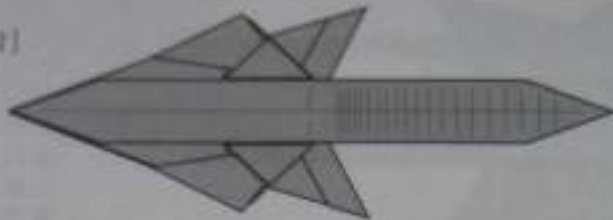

[㉟]

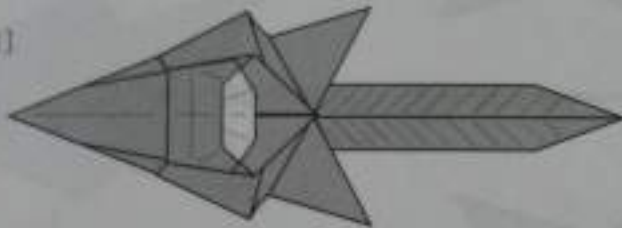

51단계까지의 완성상태 : 3-10단계
에서 만들어준 접기선을 생략하지 않
은 그림

52.

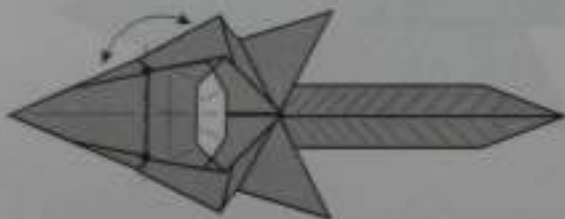

여기까진 끝까지 여기까진 안끝까지

53.

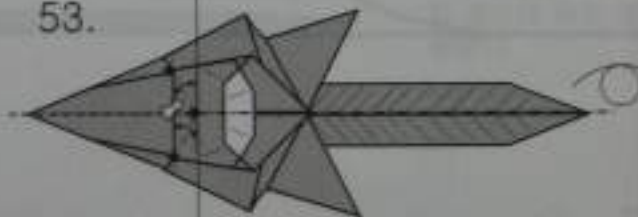

종이 전체를 반으로 접는 접기선을
만들면서 화살표로 표시된 부분도
같이 접었다 한다.

54.



복의 형태를 잡기 위한 작업이다. 복의 끝은 그림
과 같이 3등분이 되도록 접의 복이 점점 벌어지는
방식으로 접기선을 내준다. 이 작업의 완성사진을
참고하면 이해하기 쉽다.

52-54단계까지 만들어준 접기선 그림

55.

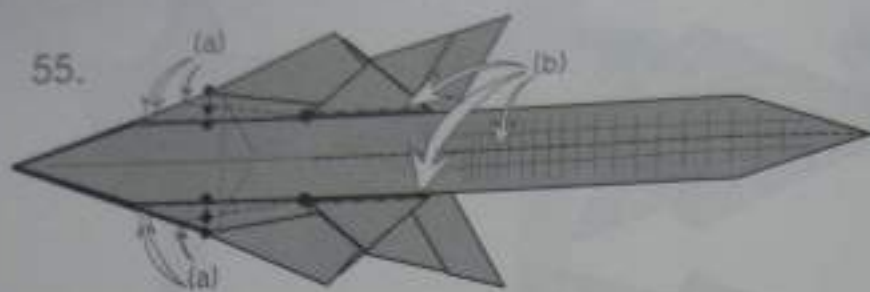

표시된 기준에 따라 (a) 기를 먼저 하면 접은 부분이 약간 볼록하게 튀어오른다. 그 후 (b)점기를 하여 기타를 입체화 시킨다. 다음 단계부터는 필요에 따라 종이 입체적 구조 이해를 돕기 위해 축만도 표적구조를 그려넣었다.

56.

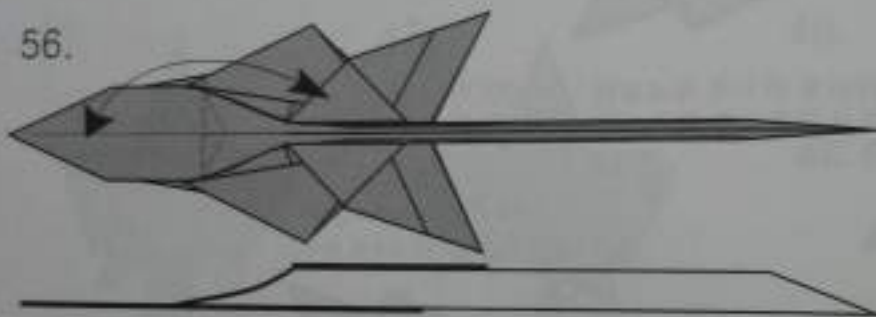

52단계에서 접었던 부분을 다시 한번 접었다 펴준다.

57.

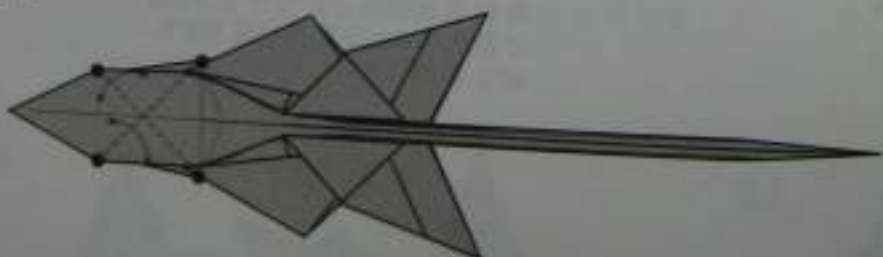

표시된 꼭지점을 기준으로 접기선을 만듭니다.

58.



59.

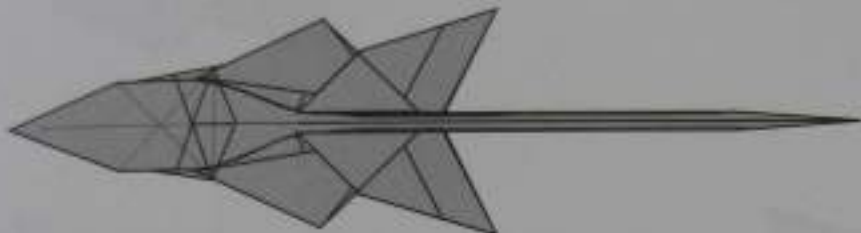
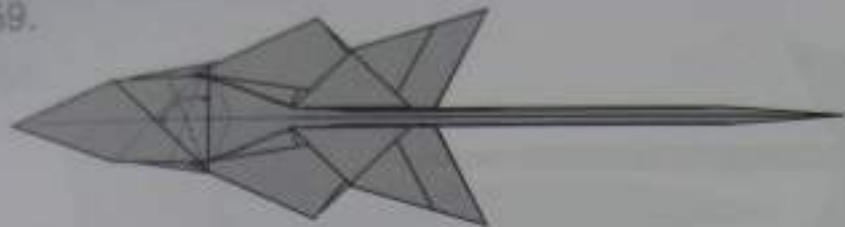

두꺼운 색선으로 표시
한 접기선이 기타를 임
체화 하는데 필요한 접
기선이다.

60.

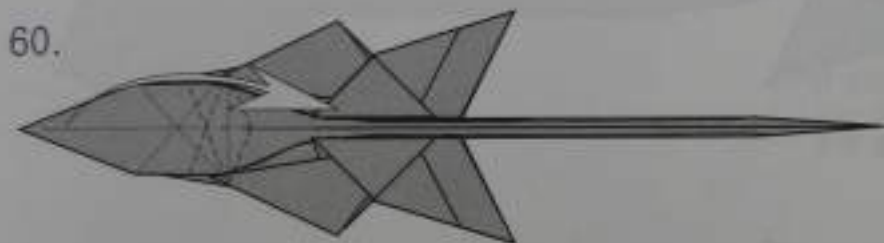

그림과 같이 접기선
을 접으며 위로 접어
올린다.



기타가 임체화 된
모습



61.



표시된 위치점이 맞을
리도록 접었다 편다.

62.

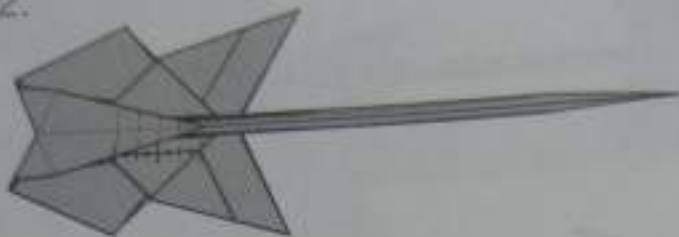

4등분 접기선을
만들고 자크재그
로 접어올린다.

63.

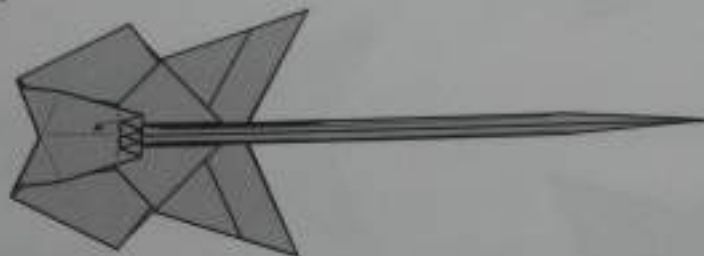

64.



기타의 줄을 고정시켜주는
브릿지가 완성되었다. 완
성된 브릿지를 종이 롤안
으로 끼워 넣는다.

65.

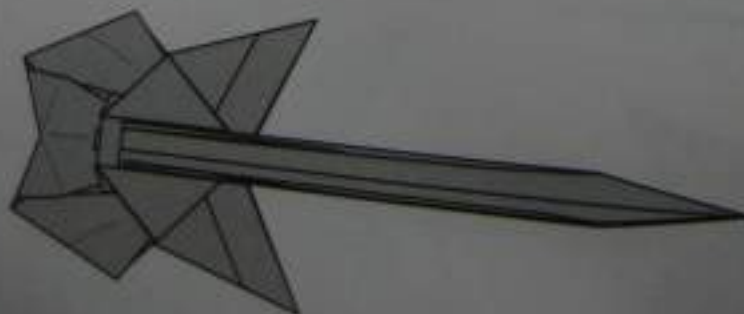

브릿지를 롤에 끼워넣은
모습

66.

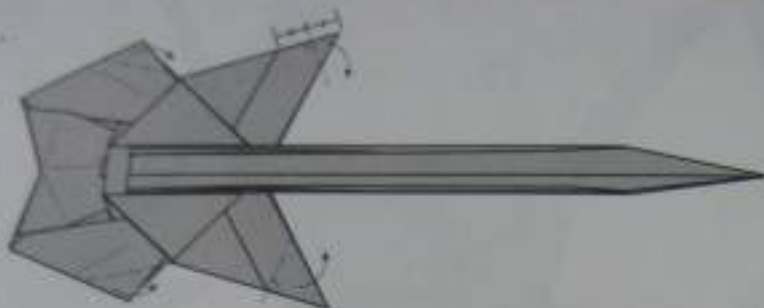

67.

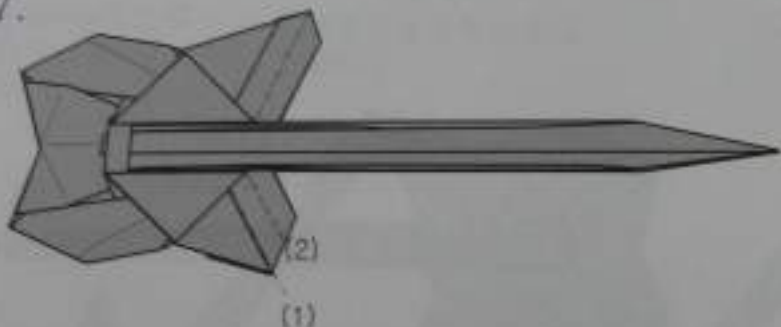

산점기 하여 다듬는다. 아
래쪽의 경우 (1)번 접기를
먼저 하고 (2)번 접기로 마
무리하면 된다. 기타가 입
체가 된 상태이기 때문에
완벽히 편하지는 않으므로
같은 이가 적당히 다듬어
주면 좋다.

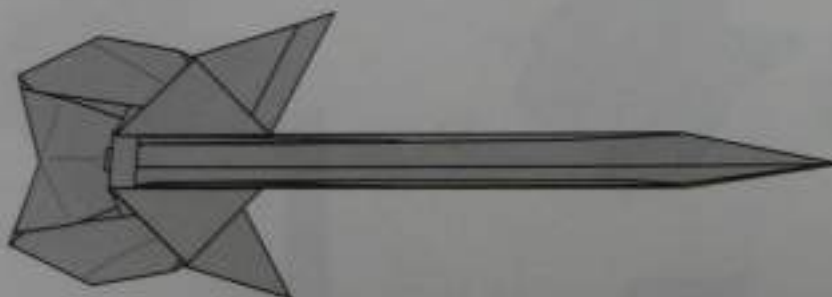

기타의 반대편도 똑같이
정렬시켜 줄 필요가
있을 것이다.

68.

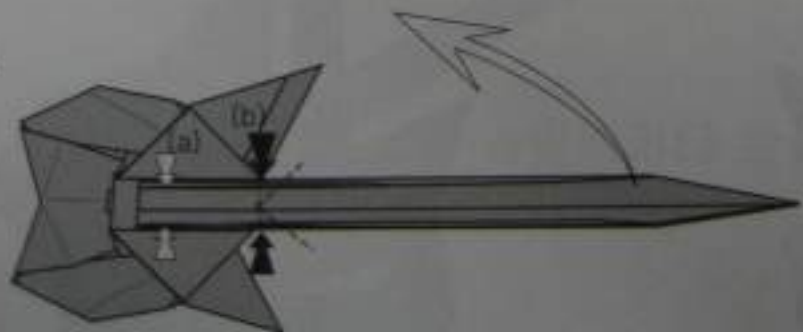

(a)화살표처럼 표현할 기타를
가운데로 가지런하게 모아준다.
그리고 (b)화살표와 같이 밖의
측면이 V자로 벌어지지 않게 모
아주면서 접기선대로 접어, 밖
을 수직으로 세운다.

69.

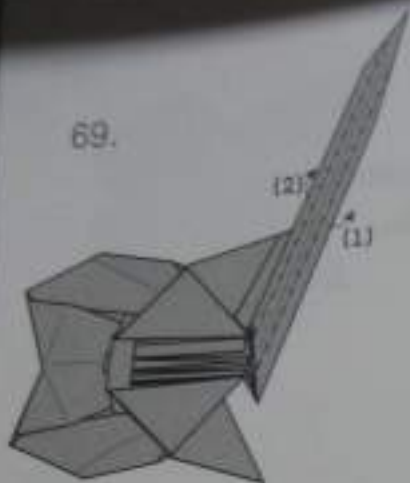

70.

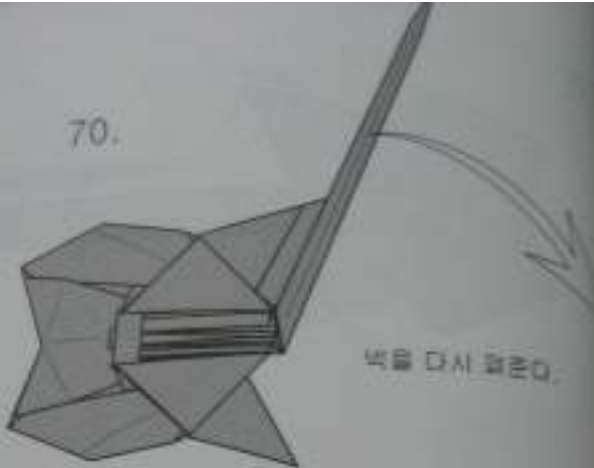

将图69中的花茎(1)折成如图70所示的形状，(2)折成如图71所示的形状，(3)折成如图72所示的形状。

折成如图70所示



71.



72.

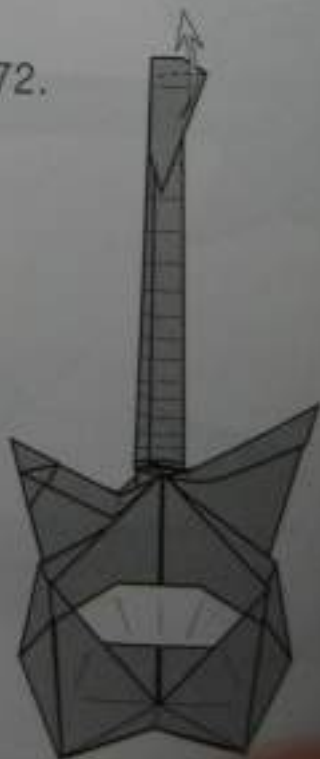

73.



74.



75.



양면의 접어놓았던 부분을 다시 한층 더 접는다.

기존선에 맞춰 접었다.

트끼 귀를 만든다.

76.

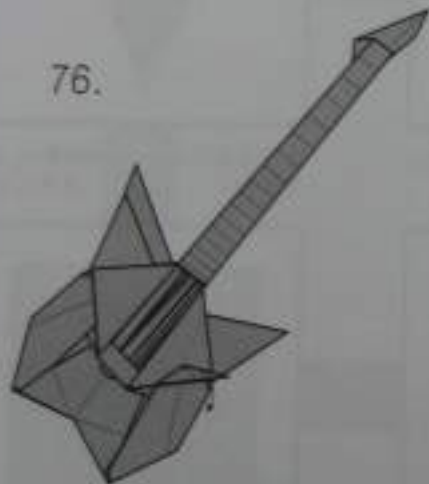

77.



기타의 픽업스위치의 형상, 접어놓은 부분을 다시 한층 더 접어서 귀를 만든다.

☆일렉기타 완성☆

Creator :
Hong-keun Jung



알바트로스 (Albatros)



- ① 종이 : 이색종 (나일론종)
- ② 종이 : 양면색종이
- ③ 종이 크기 : 15cm × 15cm
- ④ 완성후 크기 : 7cm × 7cm
- ⑤ 작업 TIP : 프로펠러의 크기에
주의해서 만들어주세요.

접기유형에서 시작



1. 선을 따라 세로접으세요.

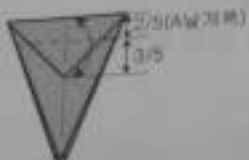

2. 3/5등분 지점에서 접기선을
만들니다. (모두)



3. 함몰접기 (open sink)를
합니다.



4. 날개쪽의 1/2만큼
제단접기를 합니다.



4. 위로 올립니다.



3-1. 전개도.



5. 세로접습니다.



7. 앞, 뒤로 접습니다.





9. 날개부분을
맞히십시오.



10. 선을 따라 앞으로 접으십시오.



11. 선을 따라 접으세요.



14. (9-13까지) 같은 방법으로
접으세요.

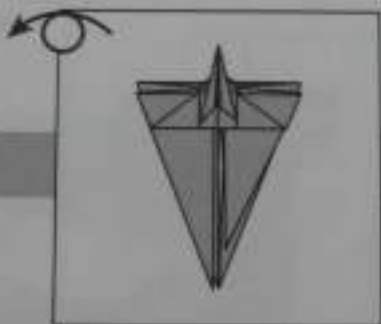

15. 뒤집으세요.

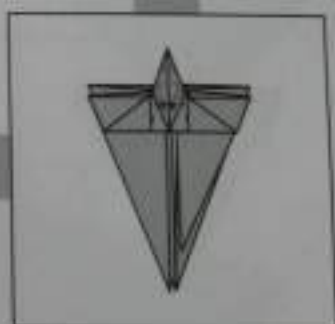

12. 중심선을
맞히십시오.



15. 앞, 뒤로 접으세요.



16. 선을 따라 접으세요.

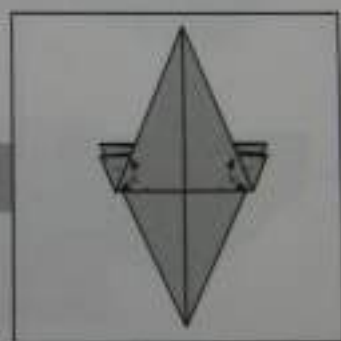

17. 접이선을
만드세요.

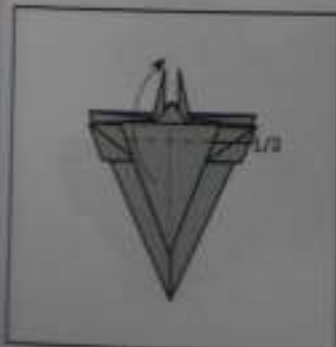

20. 날개폭의 1/2만큼만
접으세요.

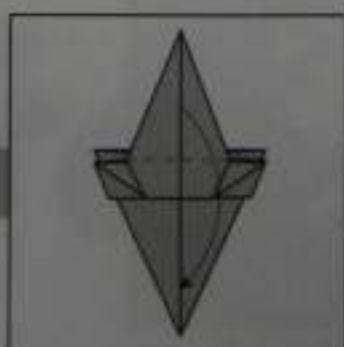

19. 내리접으세요.

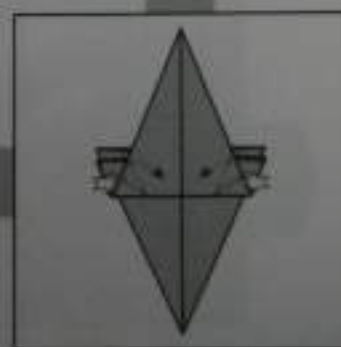

18. 안쪽선을
따라 접으세요.



21. 네모잡으세요.



22. 겹기선을 만드세요.



23. 선을 따라서 잘라
눌러잡으세요.



26. 겹기선을 따라서
잡으세요.

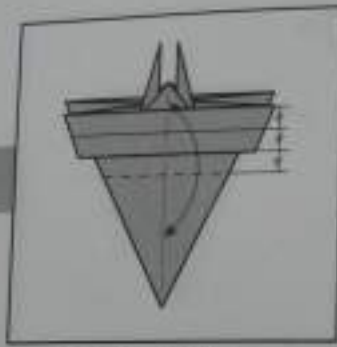

25. 남쪽쪽의 1/2지만큼까지
겹기선을 만드세요.

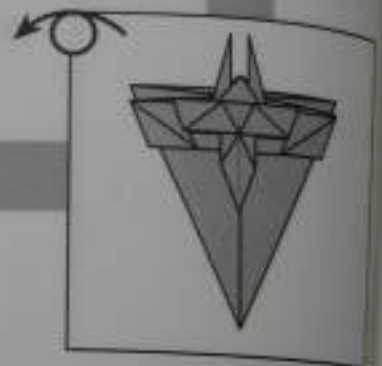

24. 뒤집으세요.



27. 눌러눌러잡으세요.

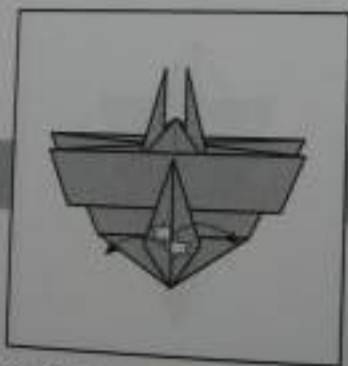

28. 앞부분으로 잘리세요.



29. 선을 따라 잘리세요.

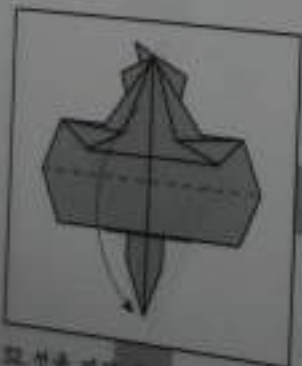

30. 선을 따라 잘리세요.

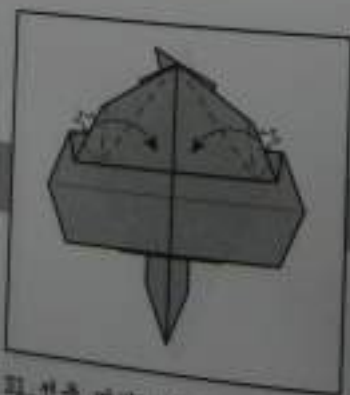

31. 선을 따라 잡으세요.





33. 날개와 크랭크를 접으세요.
(그림을 참고해서 모양을 완성하세요.)

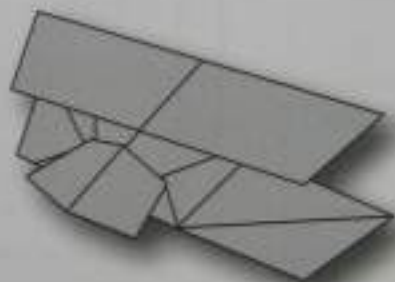

Albatros



전통의상접기 - 원삼

Korean traditional dress - Wonsam

by Oh, Kyu-Book

길이 : 15cmX15cm 1장
 허리 : 7.5cmX7.5cm 1장
 폭길 : 7.5cmX7.5cm 1장

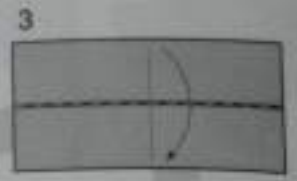
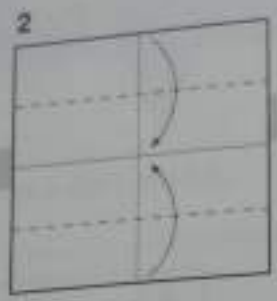
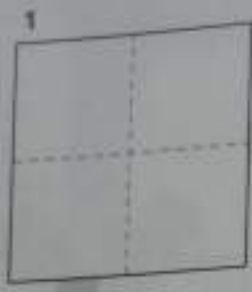

상의 part A

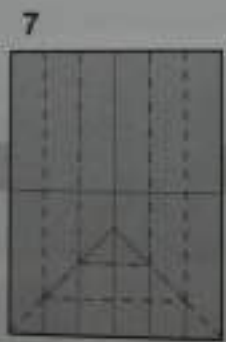
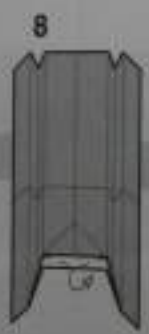
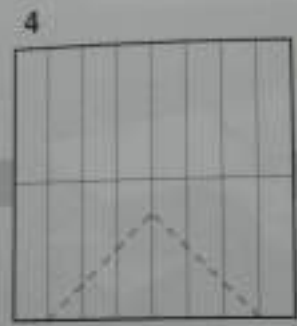
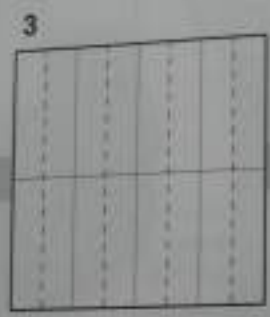
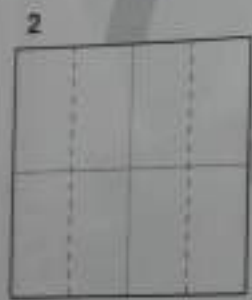

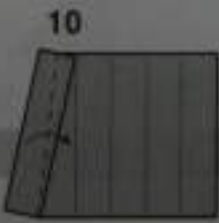
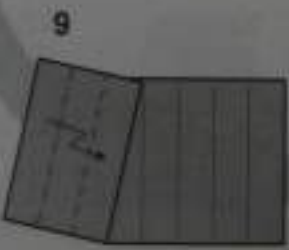
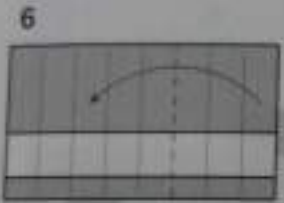
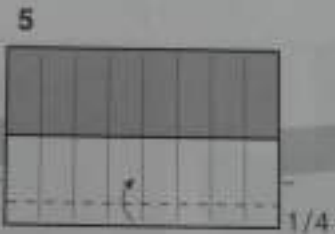

하의(슬란치마) 완성

반대 쪽도 8-10과 같은 방법으로 접는다.

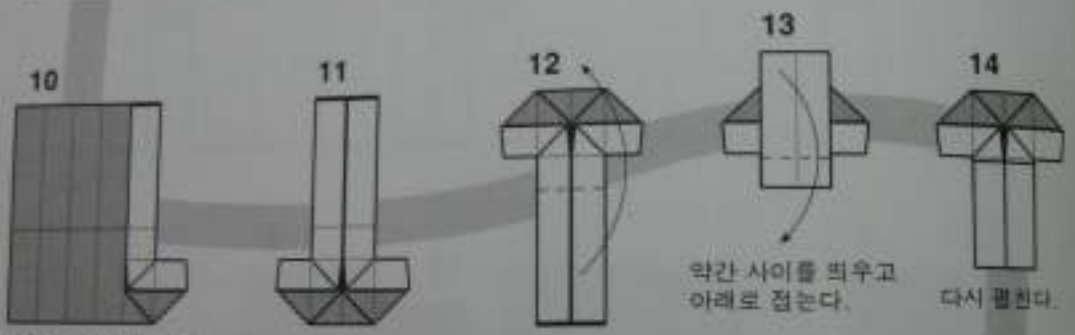
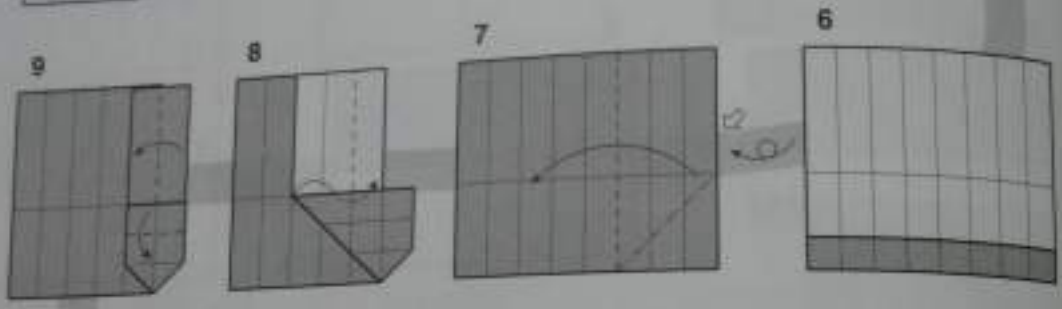
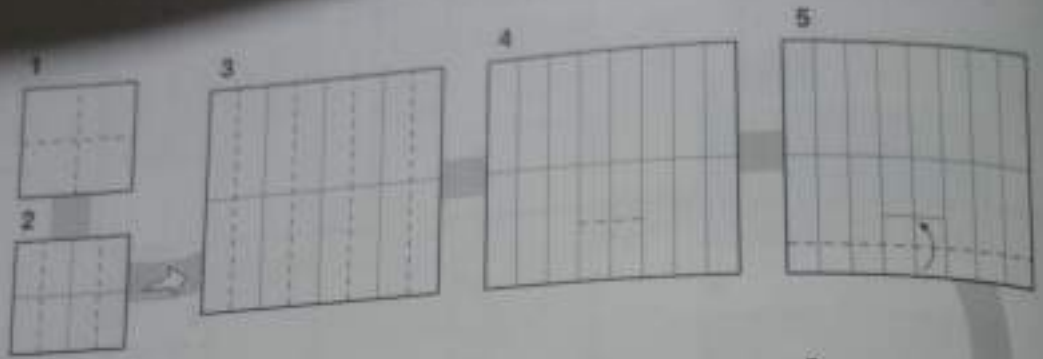

약간 사이를 띄우고
아래로 접는다.

다시 펼친다.

반대쪽도 7~10과 같은
방법으로 접는다.

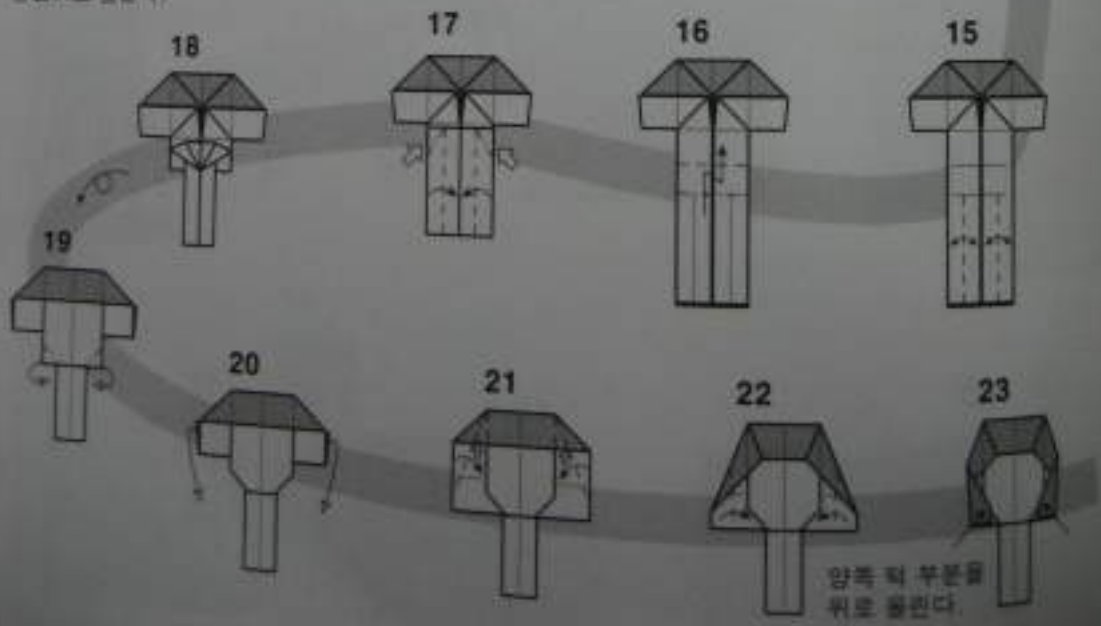

양쪽 끝 부분을
위로 올린다.

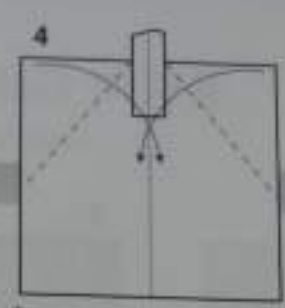
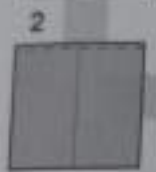

모 부분을 대고
목깃을 접는다.

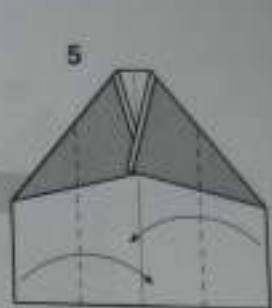

중심선보다 약간 더
접는다.

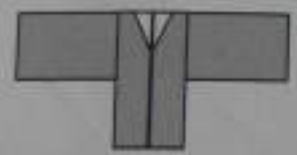

part A를 part B
사이에 끼운다.



머리를 목깃에
끼운다.



목깃 완성



머리와 목깃, 상의, 하의를
결합하고 할부관을 결한다.



머리 완성



원삼 완성

풍뎅이 Gold beetle

15cmX15cm
Colored paper

by Oh, Kyu-Sook

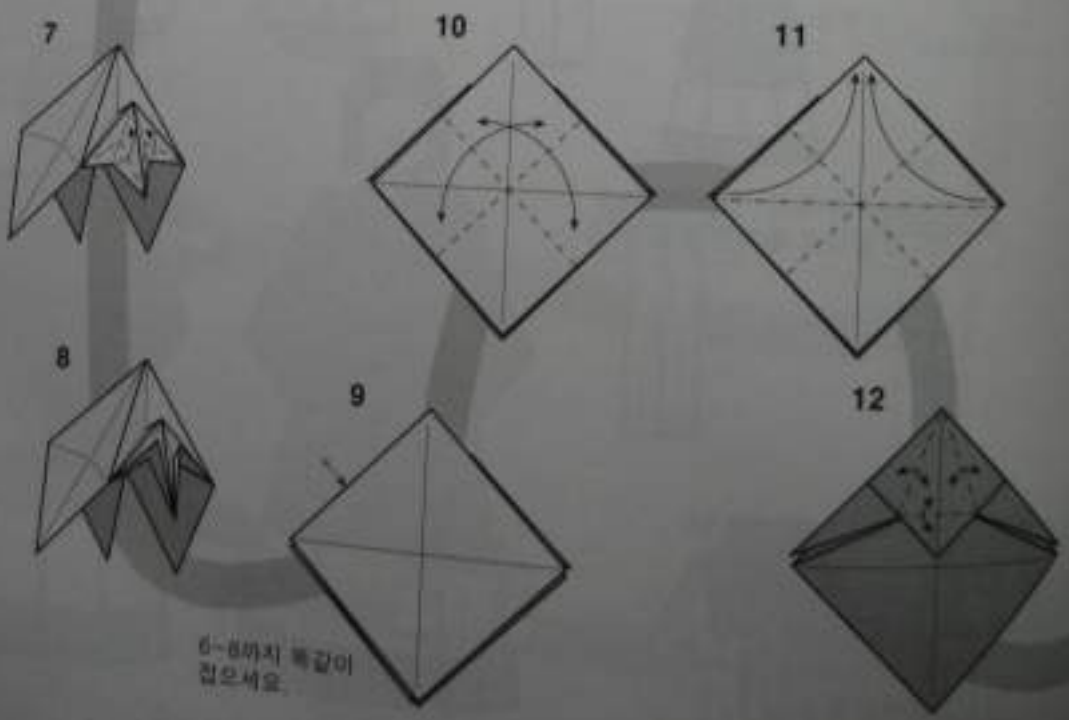
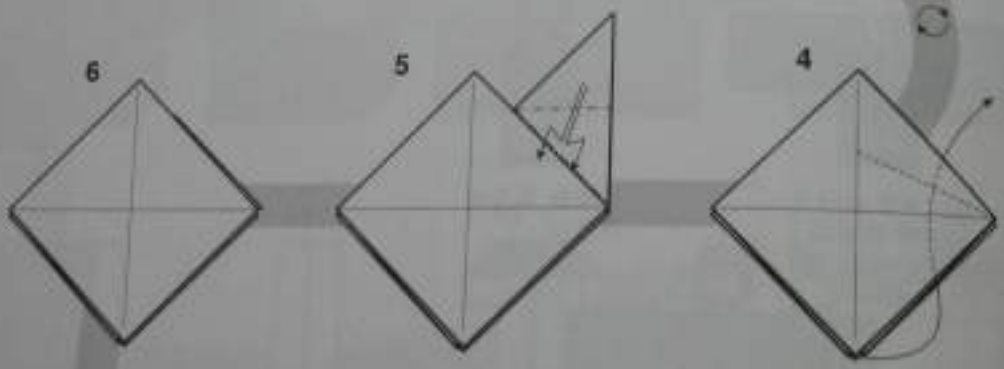
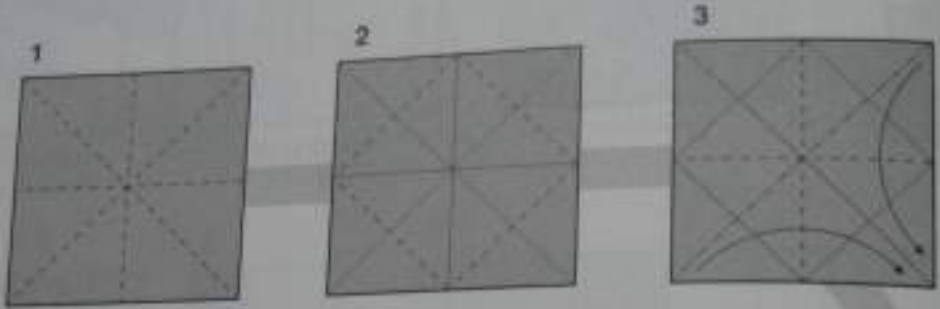

6-8까지 폭같이
접으세요.

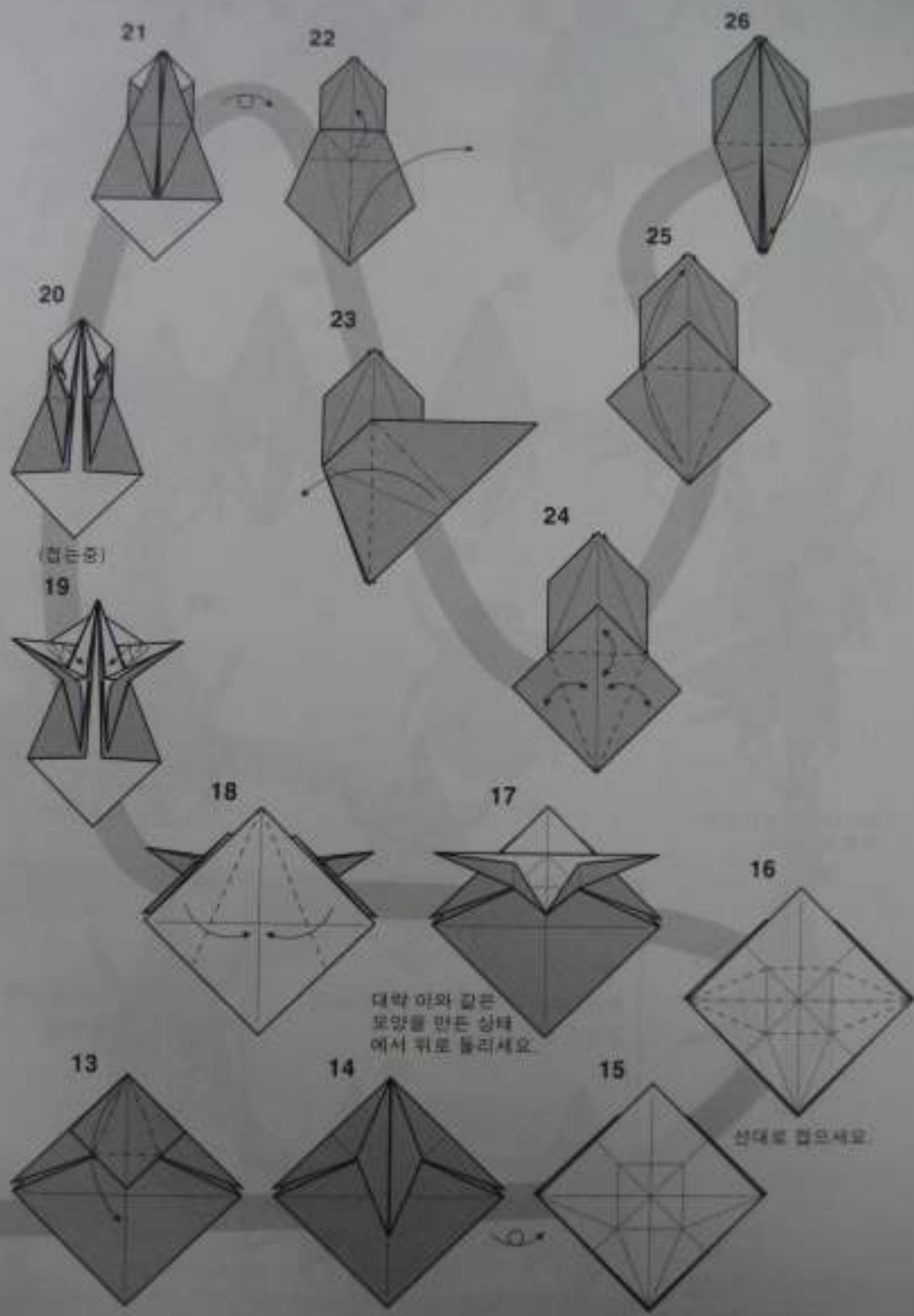

(접는중)

대략 이와 같은
모양을 만든 상태
에서 뒤로 돌리세요.

선대로 접으세요.

27



28



29



30



34



33



32



31



35



41



40



37-39까지 같은 방법으로 접으세요.

36



39



37



38



30-33과 같은 방법으로 접으세요.

반대쪽도 28-37까지 같은 방법으로 접으세요.

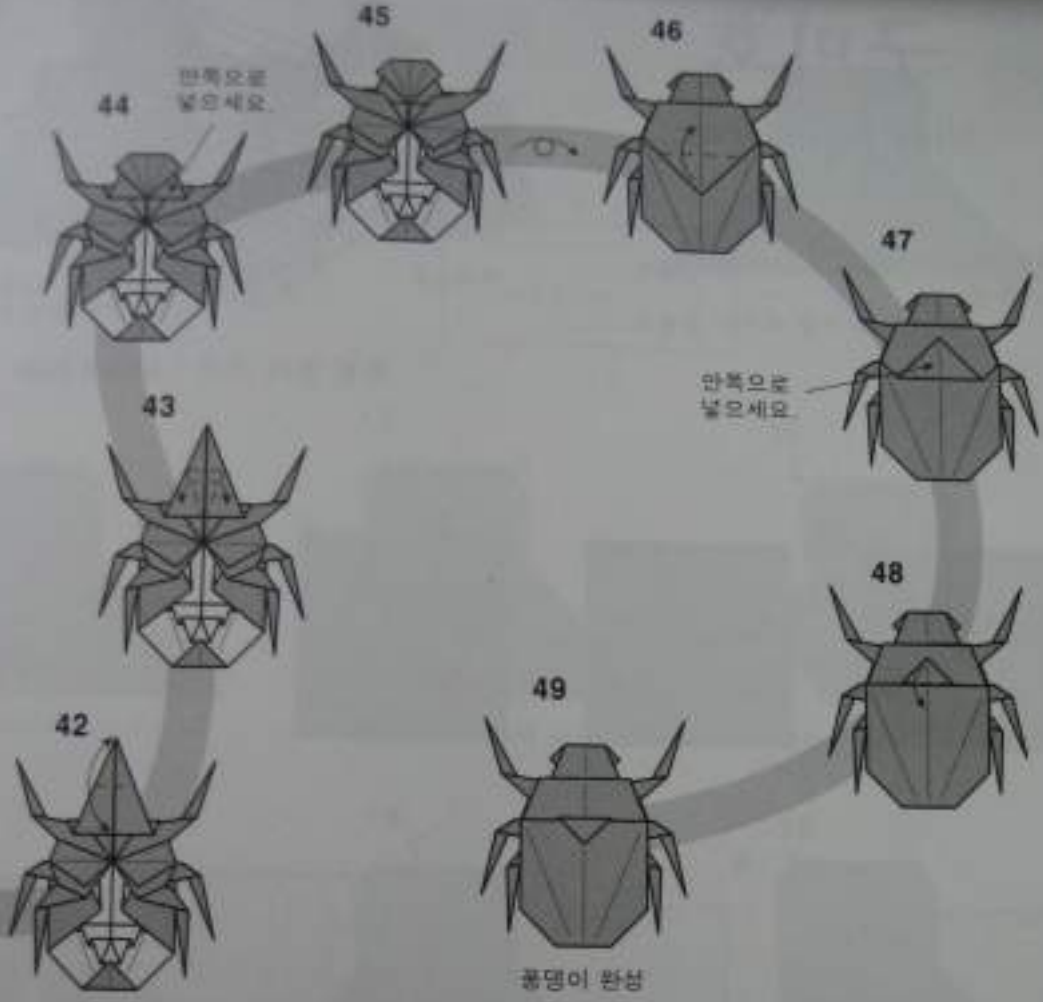

한국종이접기컨벤션
창작작품 모음집
각 권 : 5,000원

구미호

Nine tailed Fox



Diagrams & model

: 노리균

산접기

공접기

추천 종이 크기 : 30cm × 30cm

1



2



3



4



5



가로방향으로 동일한 방법으로 접어 주세요.

6



가로 세로 16등분 완성.

7

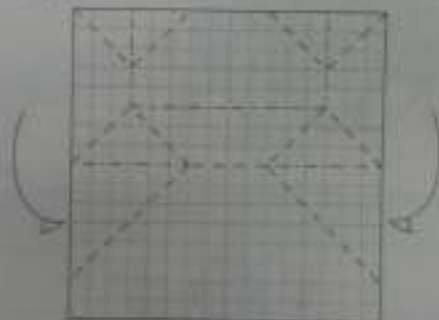

선을 따라 접으세요.

8

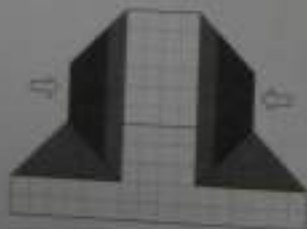

양방향으로 함몰접기 (Open sink)를 합니다.

9



중간과정

10

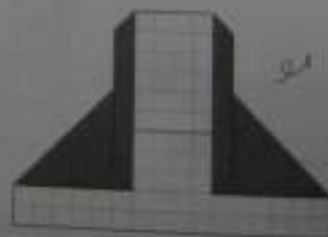

뒤집어 주세요.

11



밖으로 누르면서
위로 접어 올립니다.

12



중간과정

13



안으로 접어 넣어 주세요.

14



15



안으로 접어 넣어 주세요.

16



점선선을 따라 접어 내립니다

17



중간과정

18



함몰집기(Open sink)

19



반대편도 13~18까지의
과정을 반복합니다.

20



밖으로 누르면서
위로 접어 올립니다.

21



중간과정

22



23



가운데 면은 접어 세우면서
부채접기를 합니다.



제대로 접어지면
이런 모양입니다.
그 다음으로 네모진
각들을 어두운 부분만큼
전부 안으로 넣어 접습니다.

25



제일 바깥쪽 각을
접어 올립니다.

26

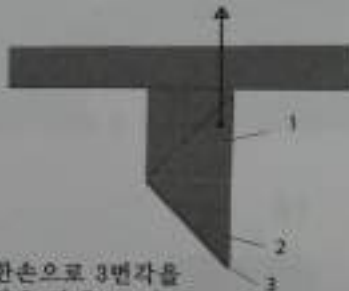

한손으로 3번각을
잡은 상태로 1번 각을
다른 한손으로 잡아 당겨서
2번각이 펼쳐져서 평면이 되게 합니다.

27

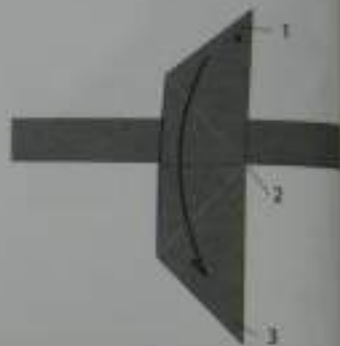

성공하면 그림과 같이
2번각이 없어지고 평면이
되어 있습니다.
1번 각을 다시 내립니다.

28



뿔다리가 잘 부분이
원형이 났습니다.

29



제대로 접으시면
삼각 펼칠때 이런
모양이 보일 겁니다.

30



이제 뒷다리에서 벗어나서 전체로 돌아옵니다. 왼쪽의 긴각을 오른쪽으로 접어 보냅니다. 반쪽에도 동일하게 해 주세요.

31



대모킨 두 부분 다 안으로 접어 넣으세요.

32



25단계처럼 네모진 네 부분을 안으로 접어 넣으세요.

33



34



각 세 개를 왼쪽편으로 접습니다.

35



왼편으로 각 하나를 접습니다.

36



37



38



네 개의 각을 왼쪽 편으로 접습니다.

이 36~37 단계는 26~27단계와 동일한 방식입니다. 3번 각을 잘근채로 1번 각을 잘라 닿지 않게 2번씩 각을 평평하게 펴서 있습니다.

39



반대쪽도 33~36단계와 동일하게
해줍니다.



꼭 부분은 위로 접어 올리고 앞다리는
뒤로 반 접어 주세요. 반대편 앞다리도
동일하게 해 주세요.

41



제일 바깥쪽 두 각을 점선대로
접었다 펴니다.

42

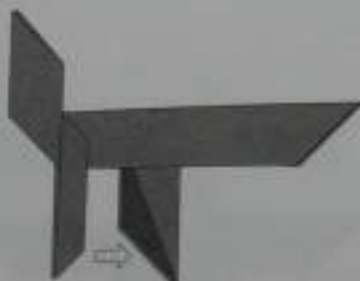

접었다 편 두각을 함몰접기
(Open sink)해 주세요.

43



남은 안쪽 각은 절기선대로
안 쪽으로 접었다 펴주세요.

44



함몰접기(Open sink)

45



이제 반대편 뒷다리로
41~44단계까지
반복해 주세요.

46



머리를 아래로 내리면서
꼬리를 위로 끌어올려
접습니다.

47



귀를 뒤로 접어 주시고
정신처럼 앞, 뒤다리를
다듬어 주세요.

48



귀를 접어 내리주시고
앞다리를 멋있게 해주세요.

49



바꾸리 다듬기

완성



* 취향에 따라 포즈를 바꿔주시면 좋습니다.

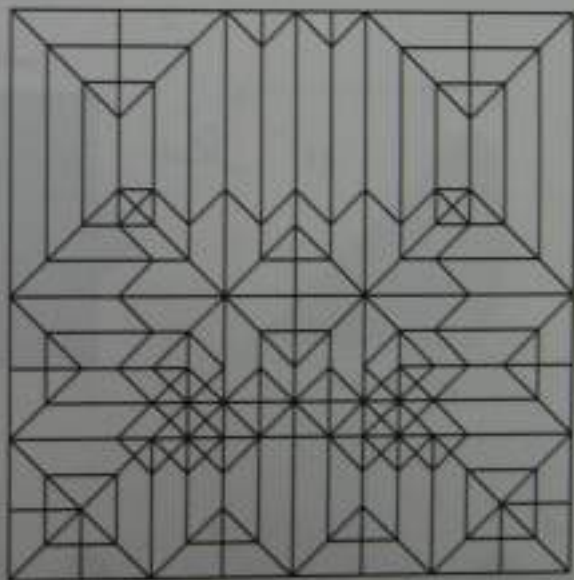

공룡기병

Dino rider

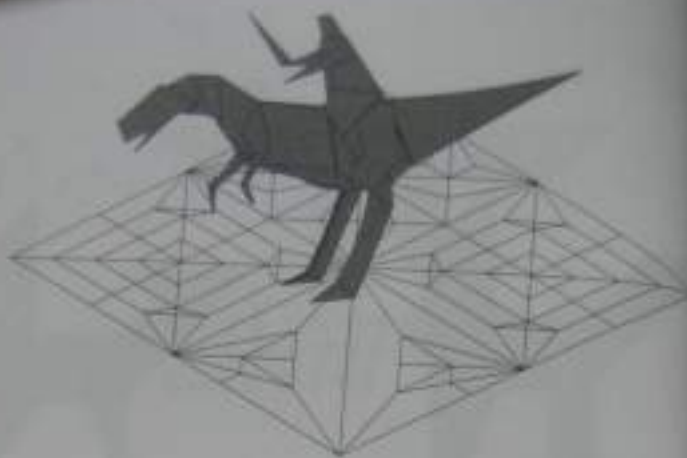

Diagrams & model : 노혁균

산점기

끝합기

추천 종이 크기 : 30cm x 30cm

1

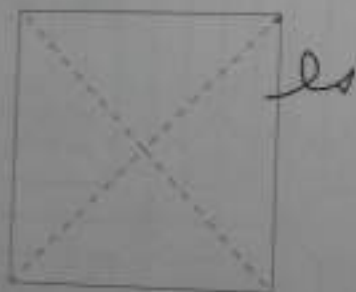

2



3



4



5



6



다시 봐서 4단계의 상태로 만듭니다.

7



8



9



다시 펼치세요.

10



함몰시키기(Open sink)

11



뒤집으세요.

12



4~10단계 까지 반복합니다.

13



14



15



다시 펼칩니다.

16



17



18



함몰시키기(Open sink)

19



화살표 방향으로
잡아 당겨 주세요.

20

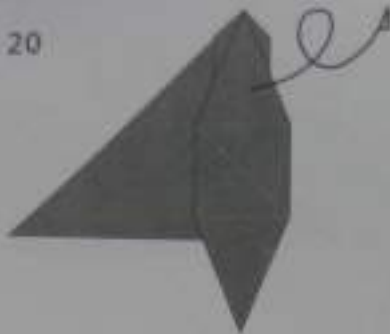

21



22



23

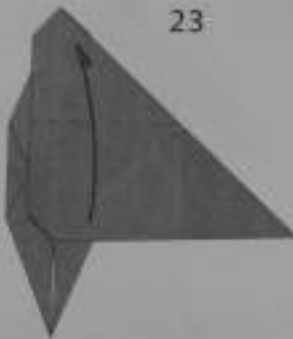

24



25



26



27



양푼집기 (Open sink)

28



29



30



31



안쪽의 오목하게 들어간
부분을 앞으로 빼 주세요

32



넓은 부분을
좁게세요.

33



34



35



36



37



38



39



40



41



42



43



26-32단계를 한번
반복합니다.

44



45



46



47



닫힌 함몰집기 (Closed sink)

48



49



50



51



함몰접기 (Open sink)

52



53

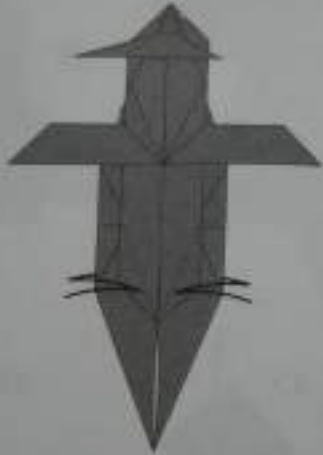

54

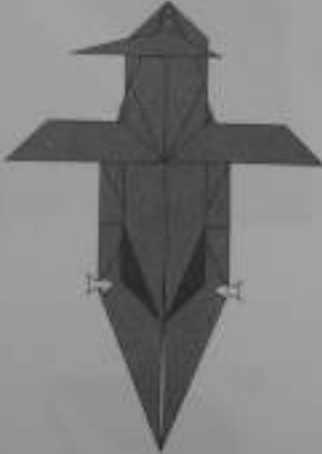

55



함몰접기 (Spread sink)

56



57

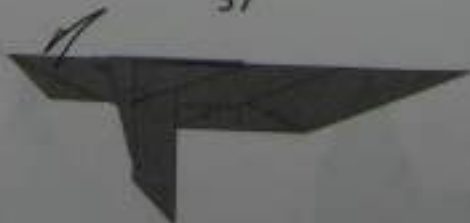

58



함몰접기 (Spread sink)

59



60



61



꽃 부분도 57~58을
반복합니다.

62



63

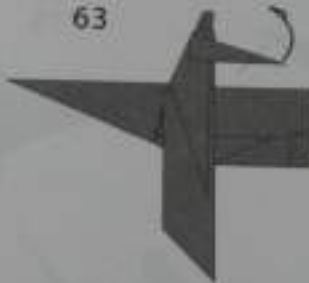

64



65



66

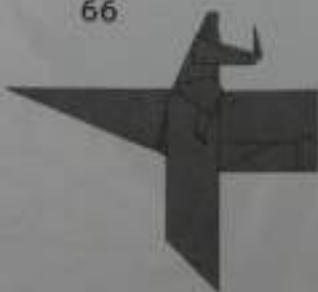

67



68



69



70



71



72



73



74



75



76



77



78



79



80



81



자연스러운 포즈를 잡아 주세요.

완성

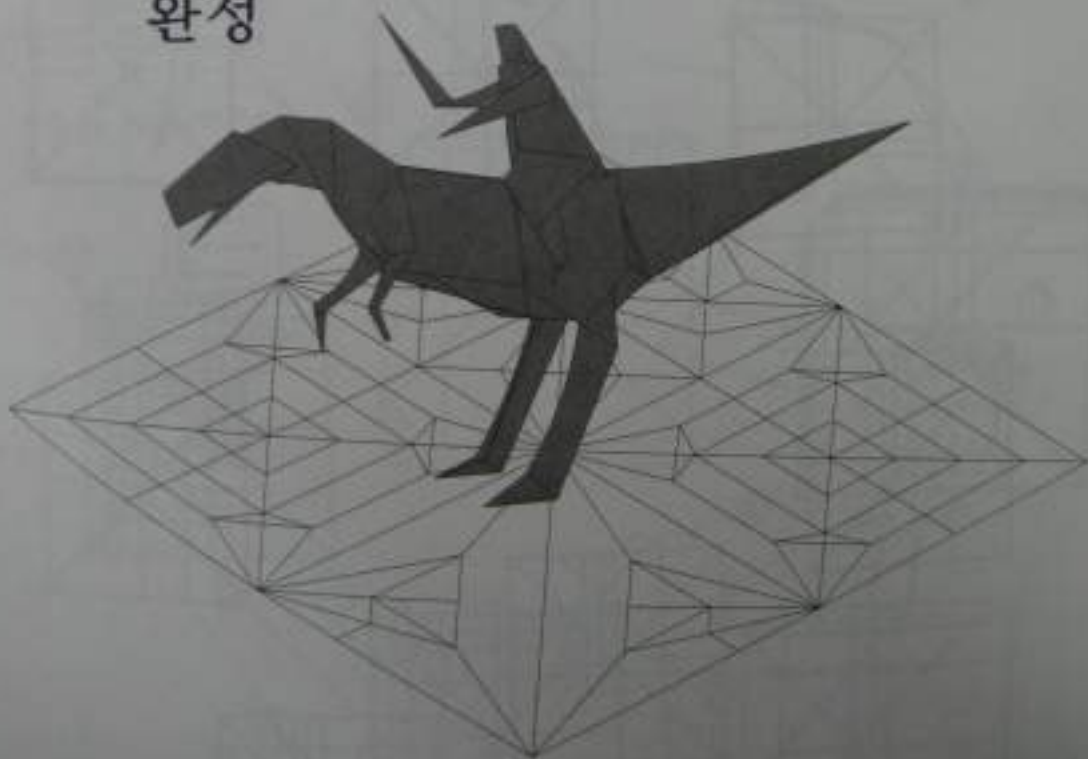

이륙(Leave the ground)

MODEL : 2007.12
DIAGRAM : 2008.5
by 이인섭

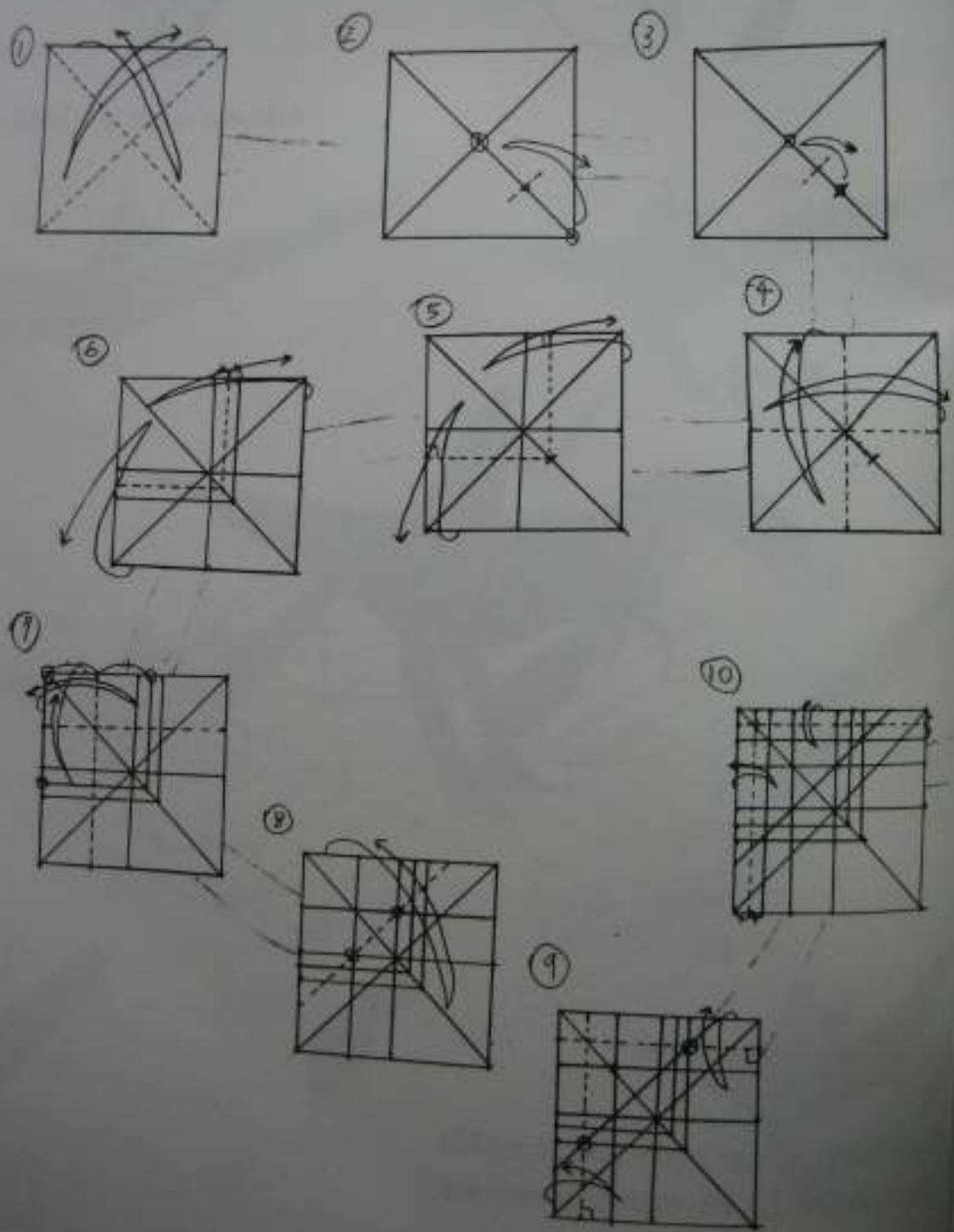

17

18

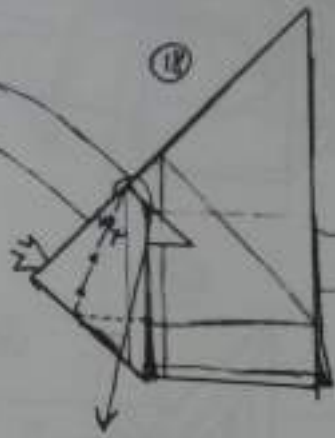
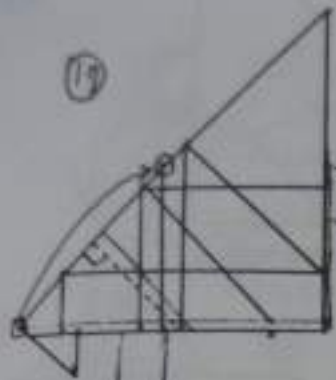

14

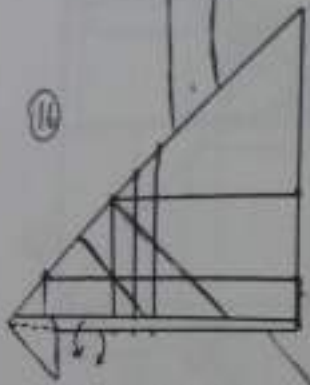

양쪽 모두 내립니다

15

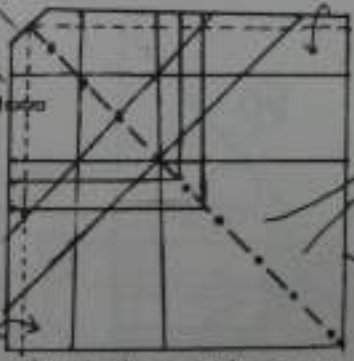

아래의 각은 아래로 쥘습니다

14

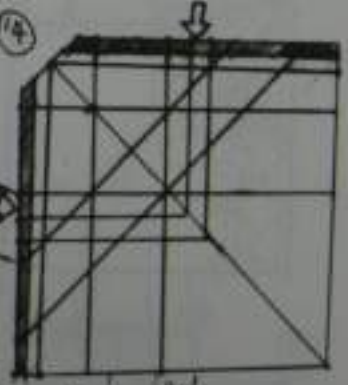

open link

11

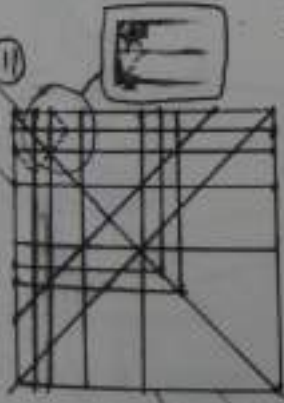

12

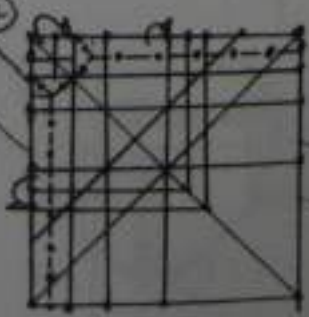

13

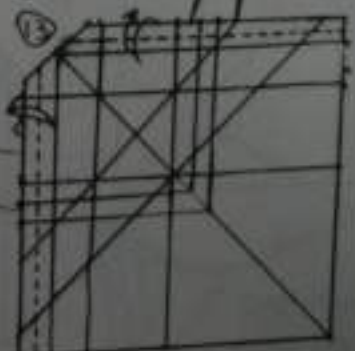

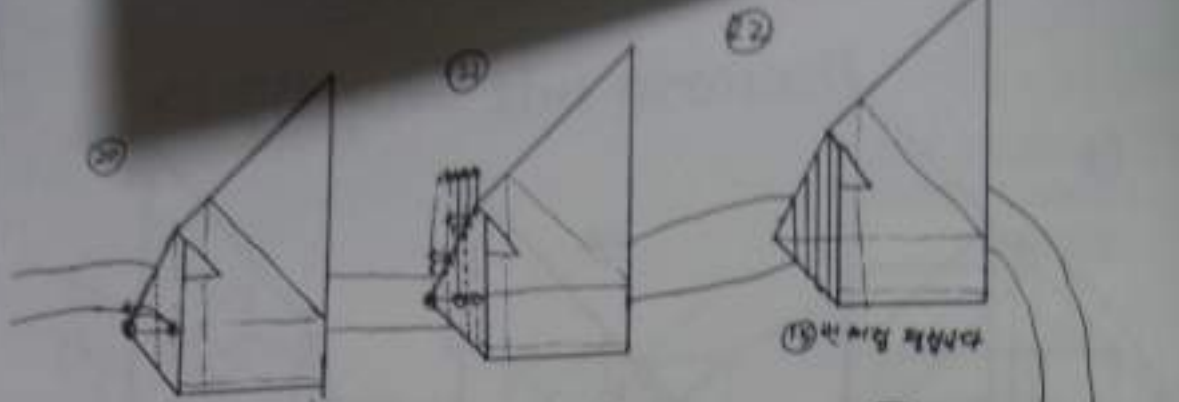

19번처럼 작성한다

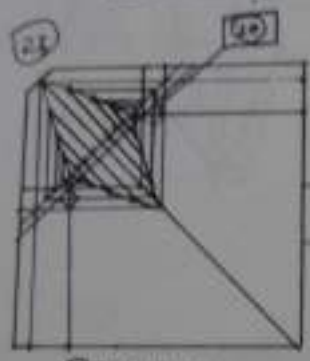

21번처럼 작성한다

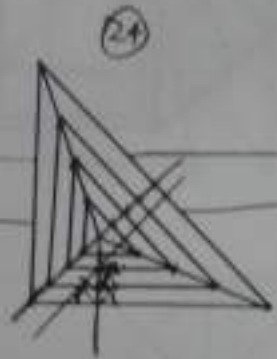

22번처럼 작성한다

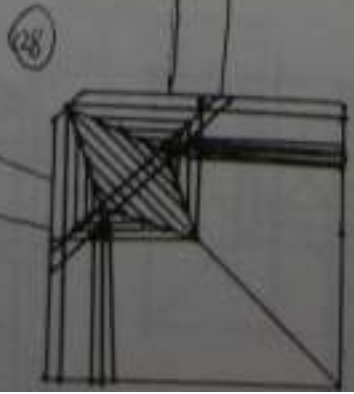
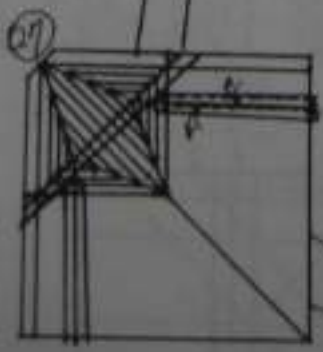
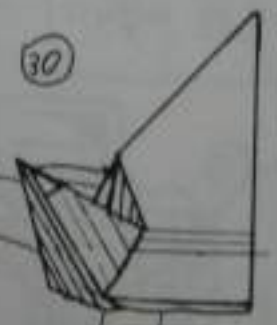
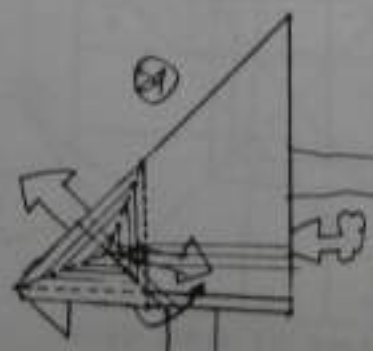
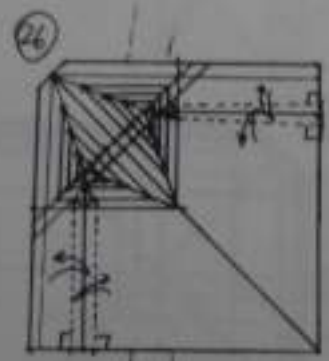
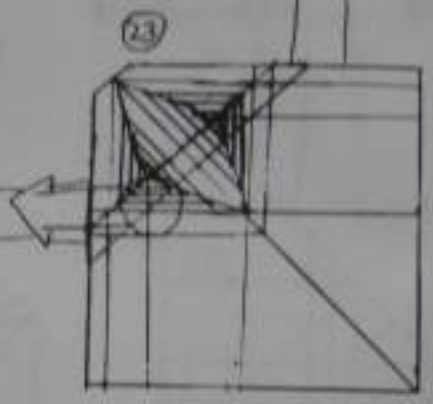

open sink

30

31

34

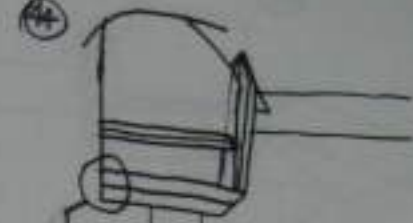

30에서 만든
사각형을 누릅니다

37

32

33

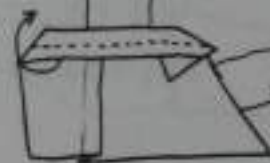

1장을 뒤집고 종이를 90°
틀리고 종이 한께도 뒤집습니다

38

39

36

35

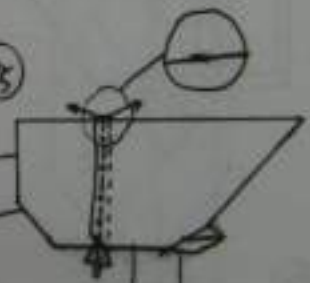

종이를 아래위로 뒤집어
줍니다

30에서 정수선을 이용합니다

32

33

34

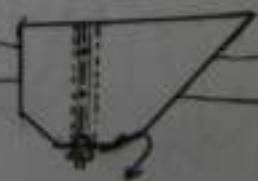
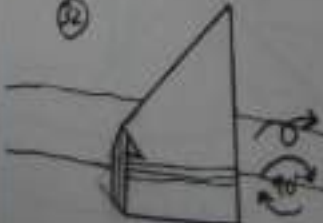

종이를 90° 틀리고
뒤집습니다

뒤집은 종이 한
얇께로 잘라줍니다

45

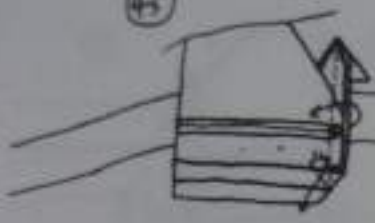

46



47



중이를 두번로
90도 돌립니다

48

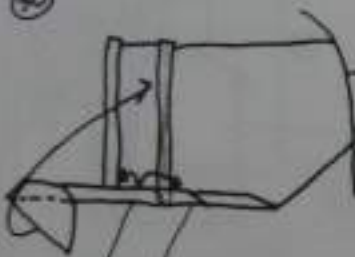

49



중이를 아래 위로 뒤집습니다

50



51

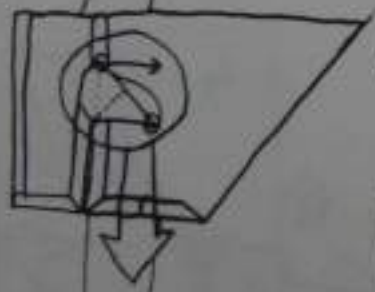

53

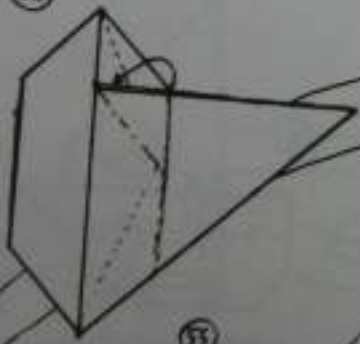

54

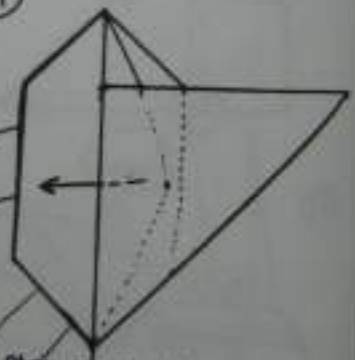

안쪽에 있는 각 1점을
2번씩 넣습니다

52

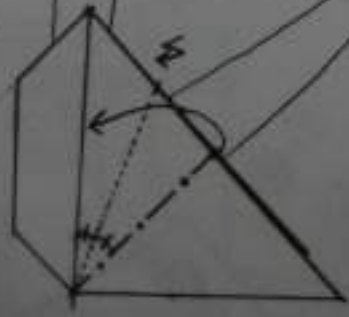

55

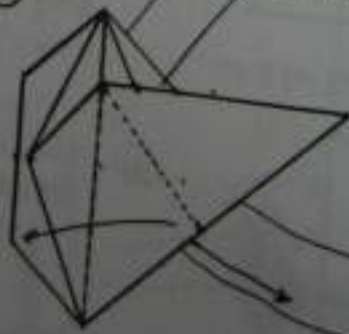

67



65

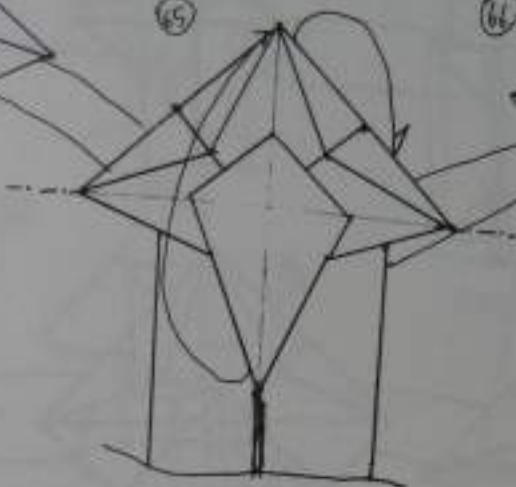

66



바깥 중심이 중심
등어입니다

63



58 ~ 63

62



한 점을 전 방향으로 옮기고
2개의 선을 한 번에 접습니다

61



1점을 옮깁니다

60

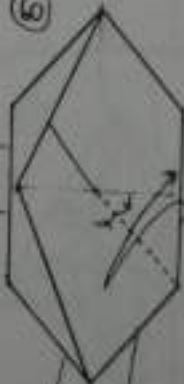

59

57



58



54



7점을 옮깁니다

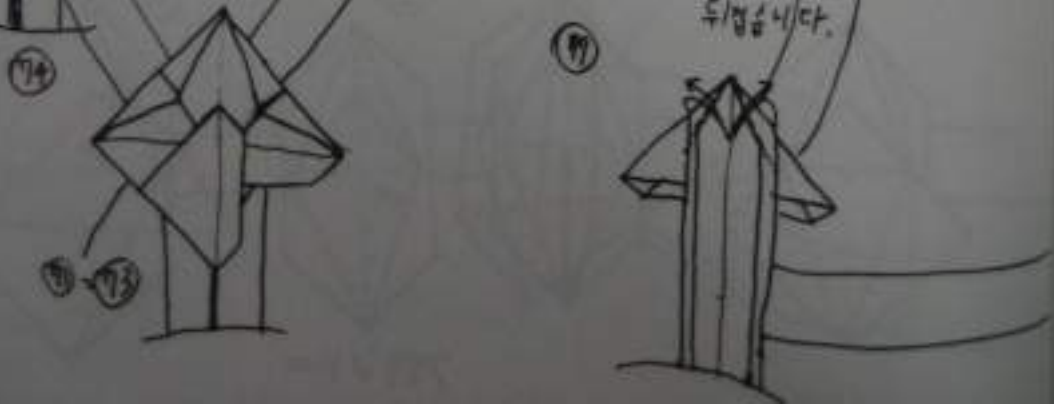
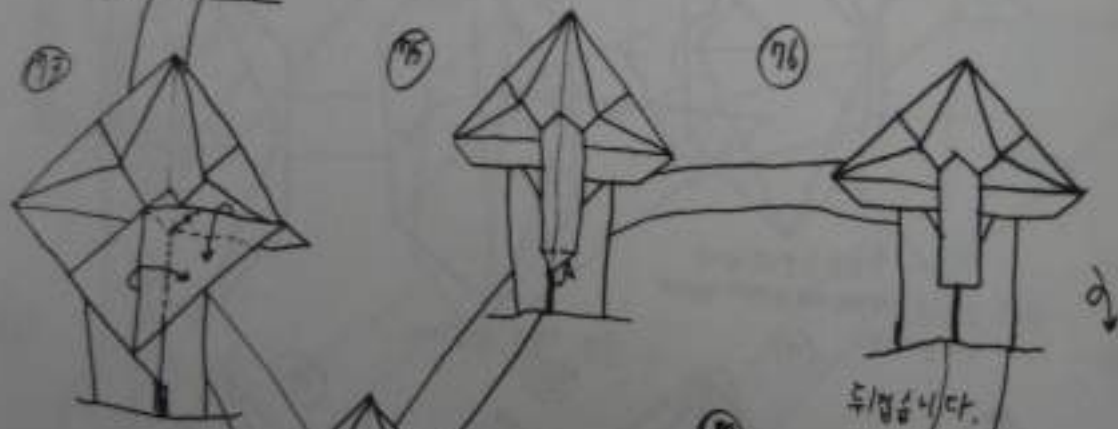
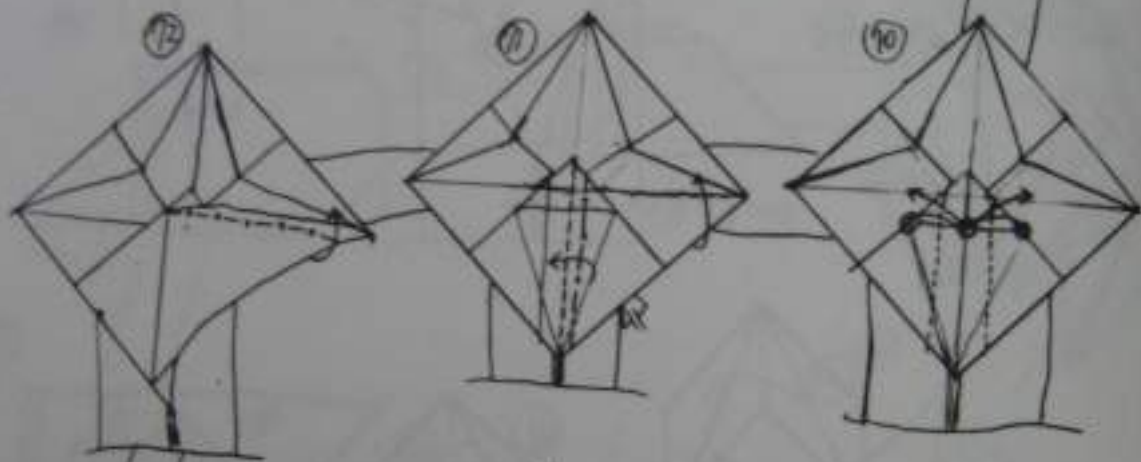
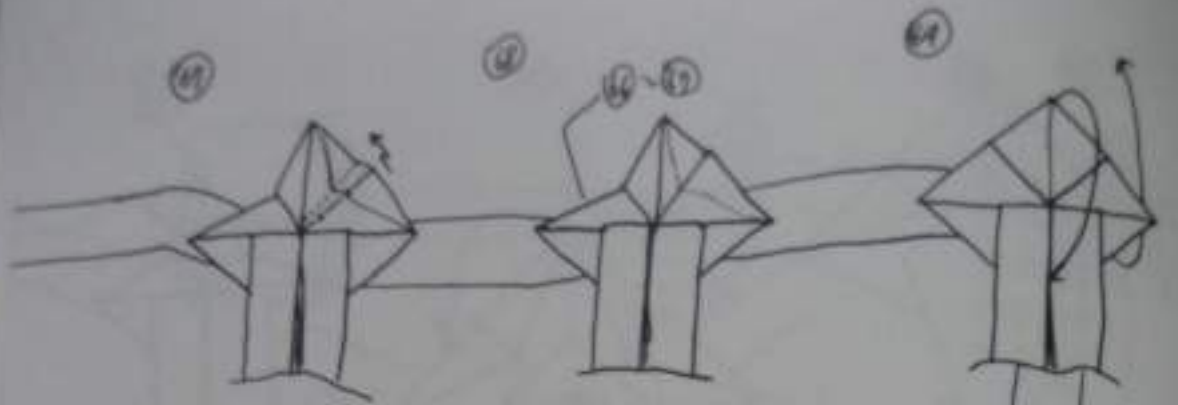

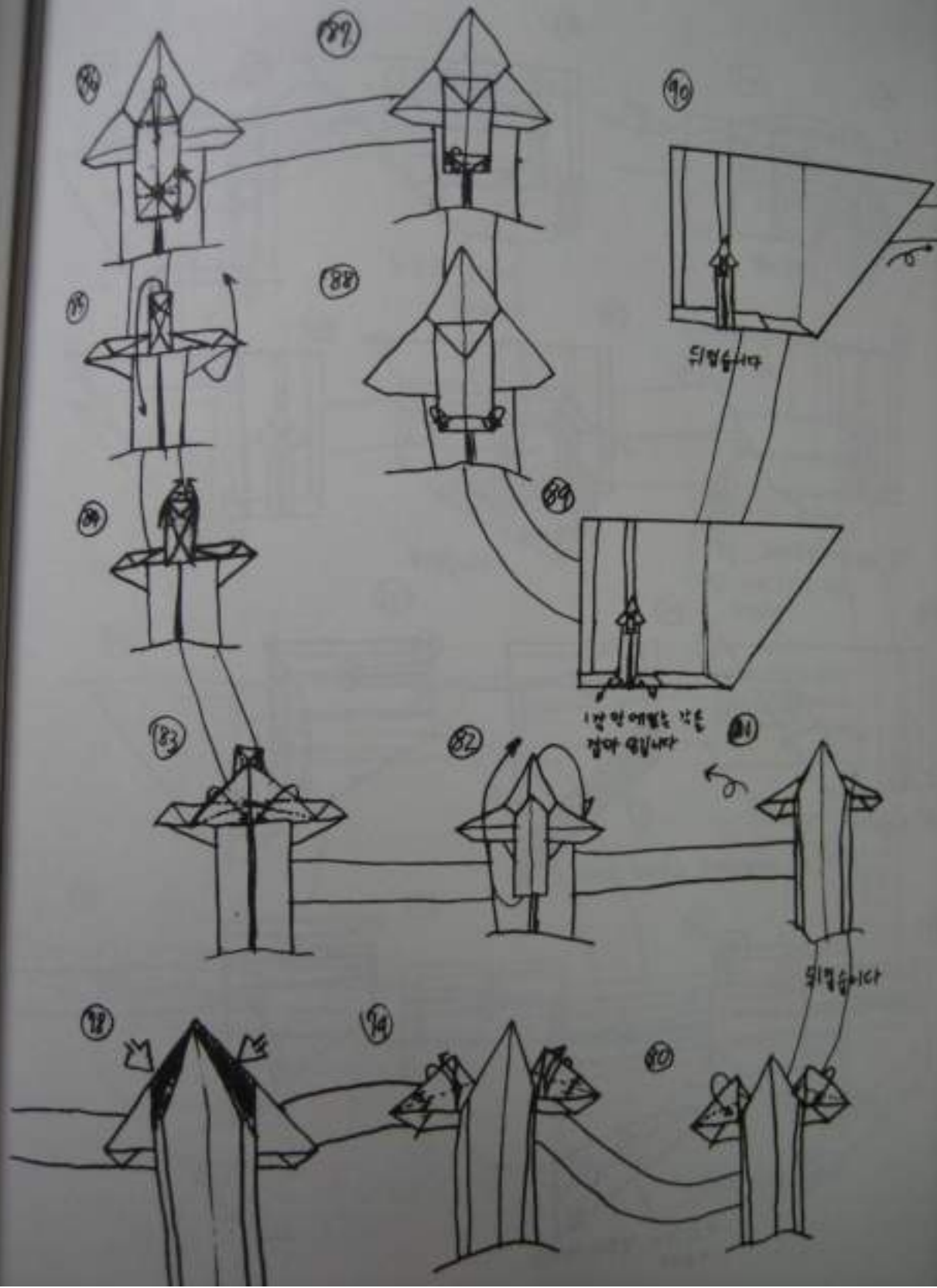

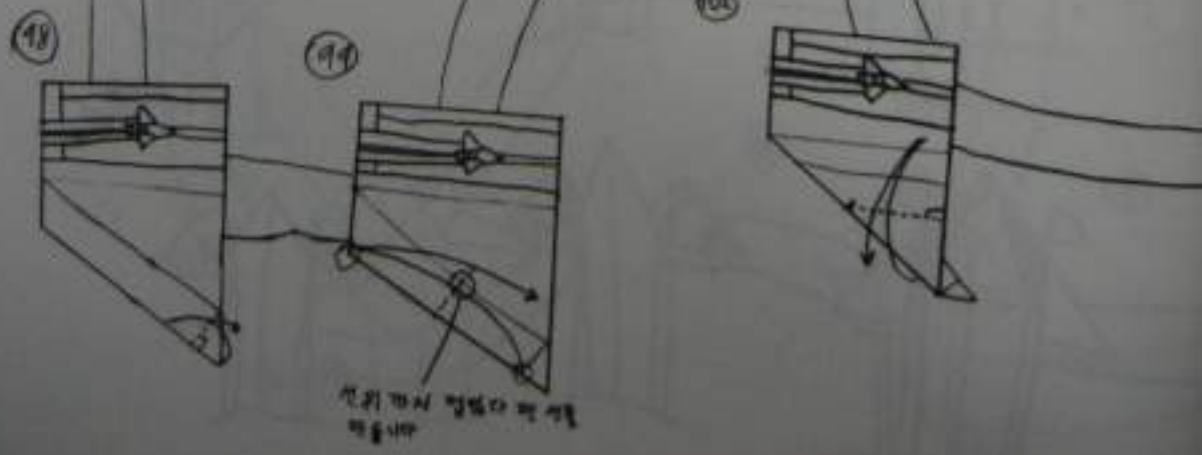
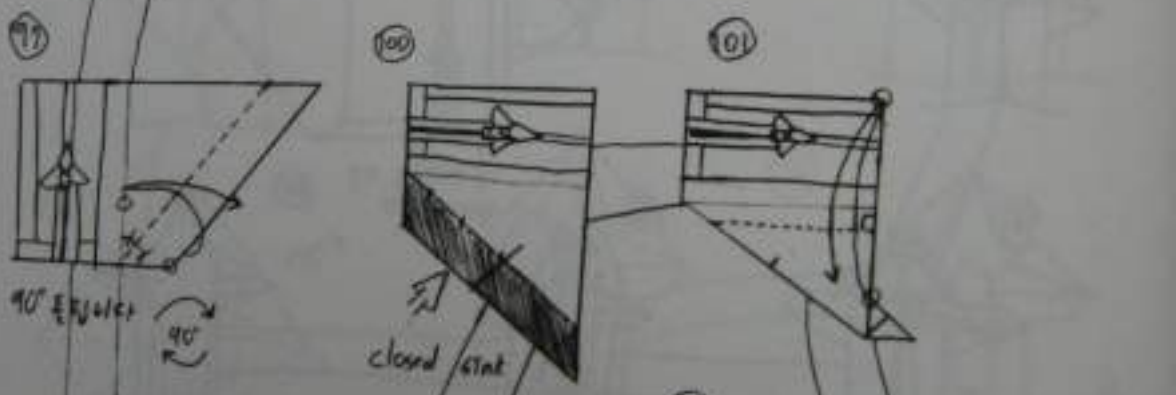
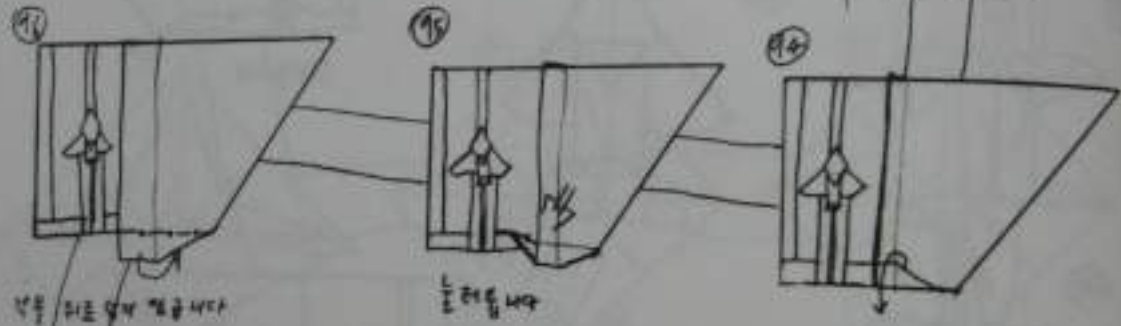
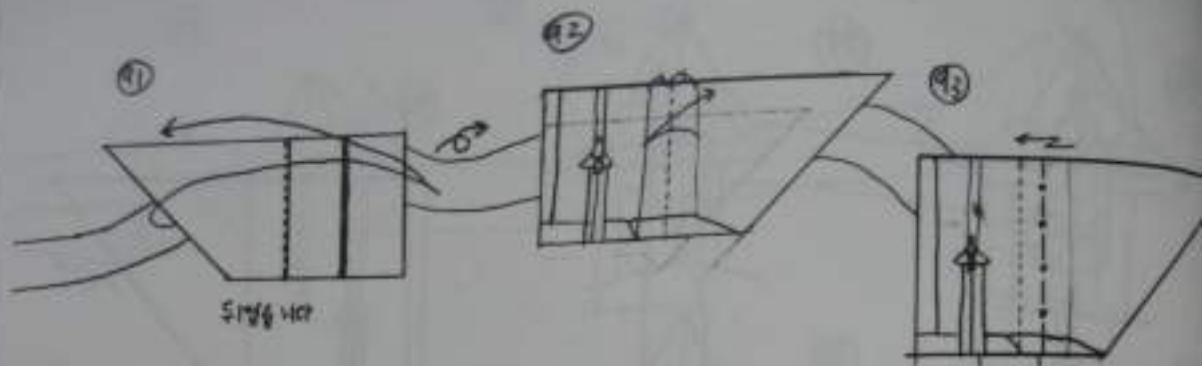

114

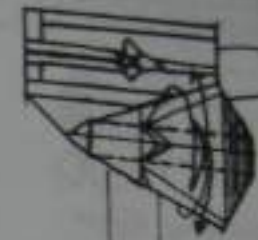

113

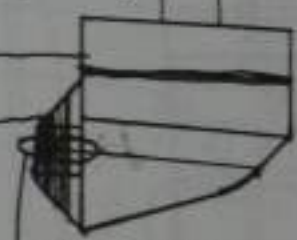

사양이 다르므로
다시 보아야 할 것

112

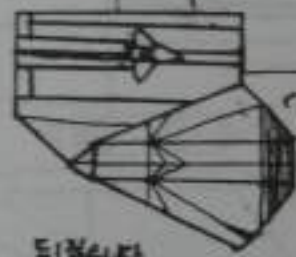

사양이
다릅니다

111

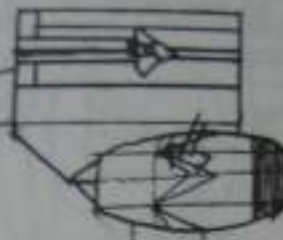

중양선을
받아서
다시 그려야
합니다

110



109



7:1

101

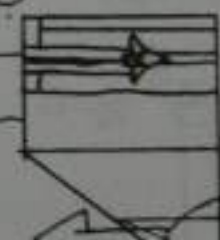

양이
다릅니다

100

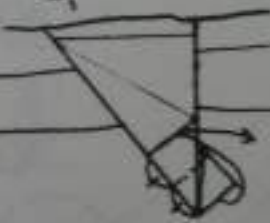

102

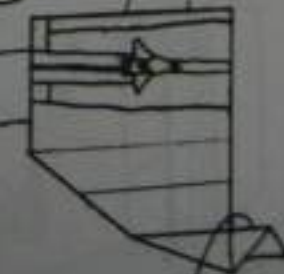

사양이
다르므로
다시
그려야
합니다

103

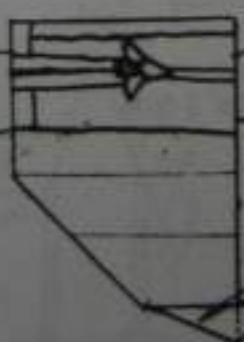

105



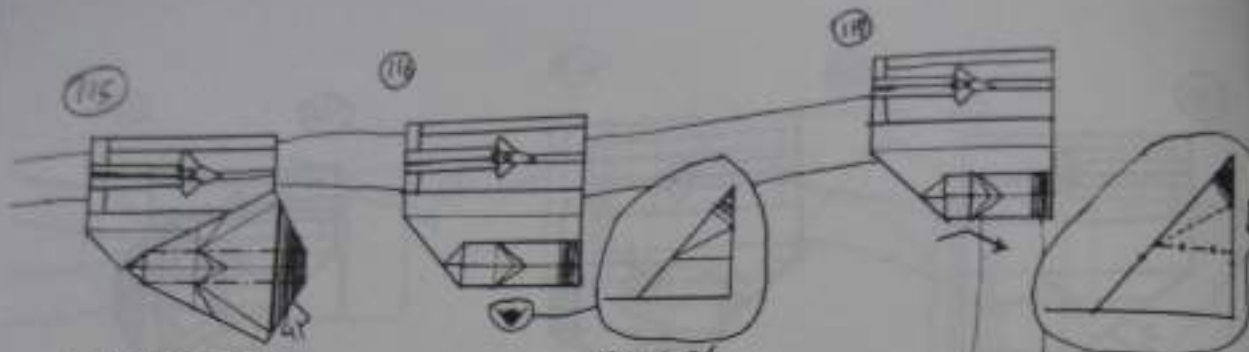

115
이제와 밑으로 깎습니다

116
옆에서 큰 모습

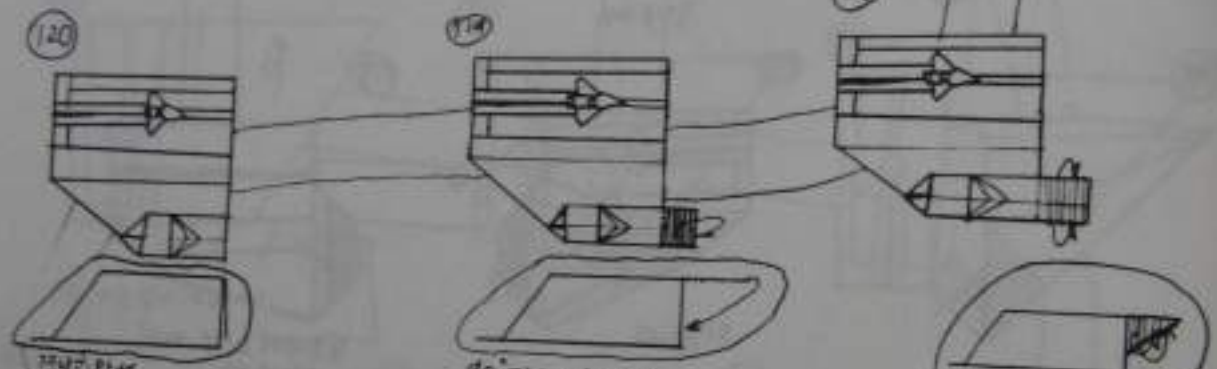

120
적당히 완성
후에 더하고
90도 돌립니다

119
90도 접어 내립니다.

118
상문의 작은 부분에 있습니다

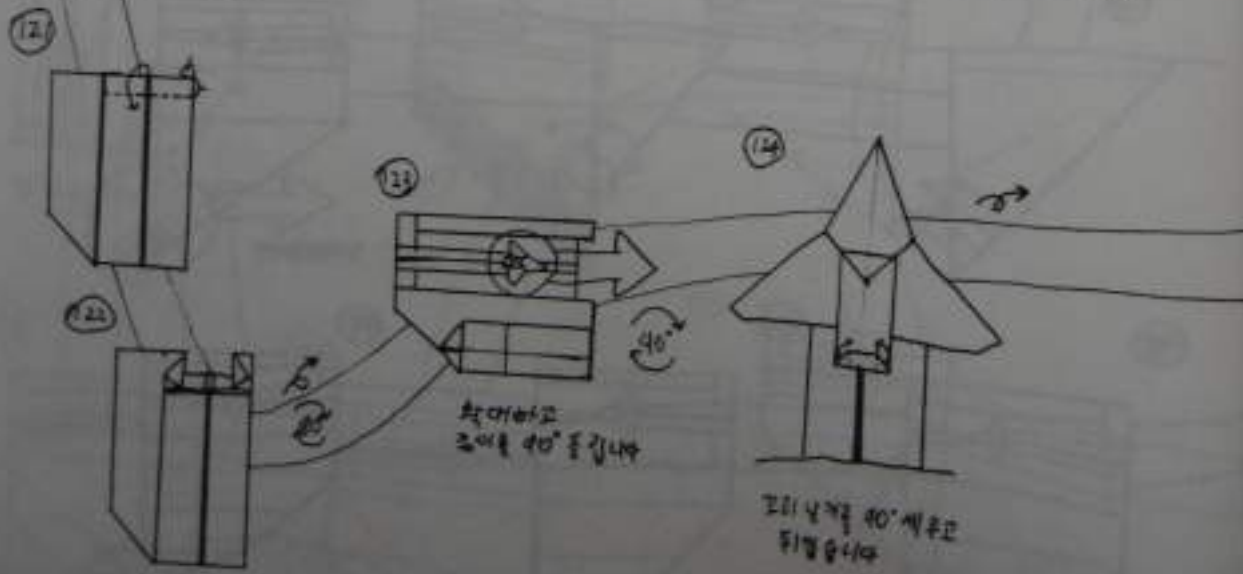

122
공이 더이상
90도 돌립니다

121
확대하고
크이를 90도 돌립니다

123
표의 높이를 90도로
뒤집습니다

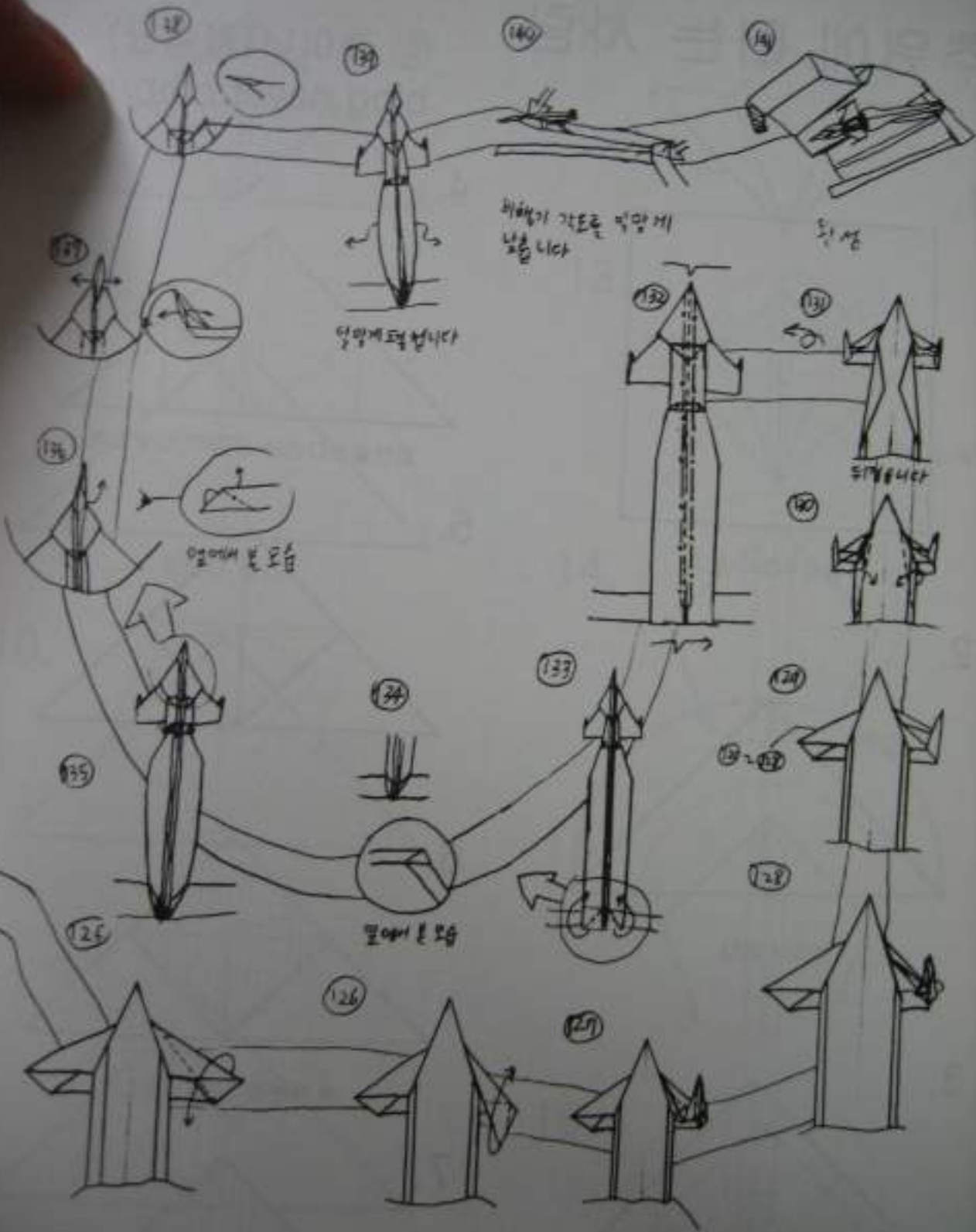

127

129

140

141

128

정말게 되겠습니다

위해가 적은은 정말게
놓습니다

동서

뒤쪽입니다

옆에서 본 모습

134

137

139

135

옆에서 본 모습

136-138

125

126

127

128

추위에 떠는 사람

© 레이너(김승균)
 blog.naver.com/jr34

1.

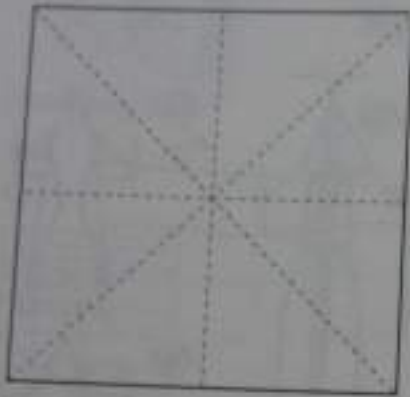

삼각주머니 접기

2.



접었다 편다

3.

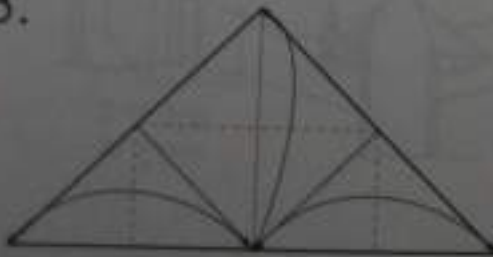

접었다 편다

4.

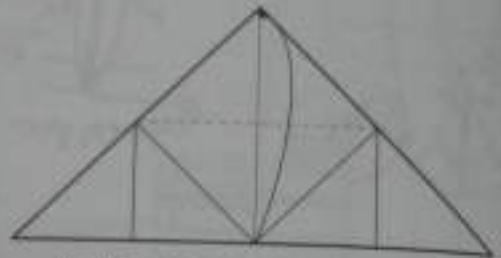

접어올린다(5의 모양이 나오도록)

5.

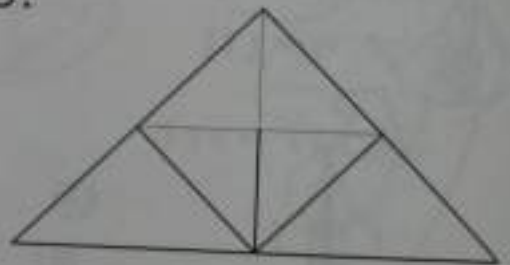

6.

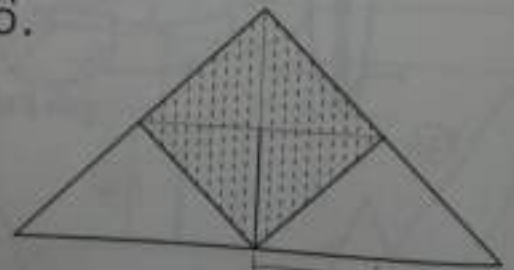

양쪽에만 16줄씩만

7.

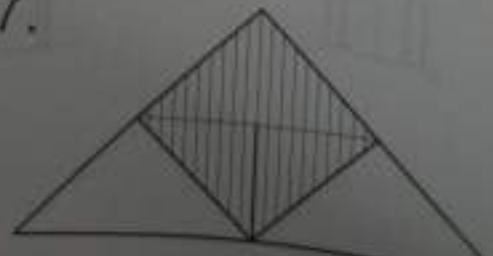

8.

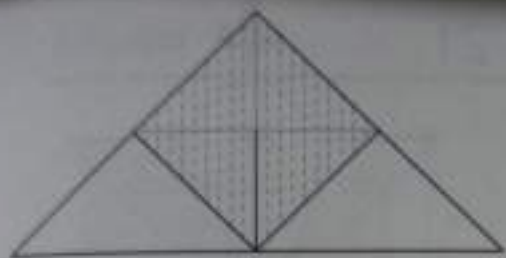

9.

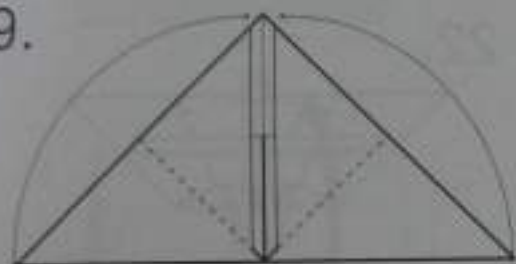

꼭꼭다 꺾다

10.

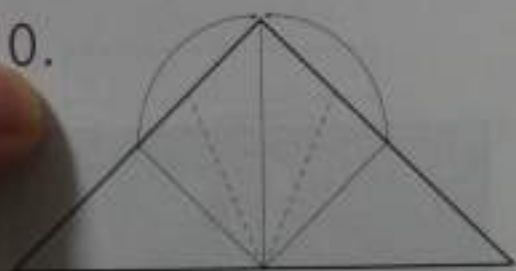

11.

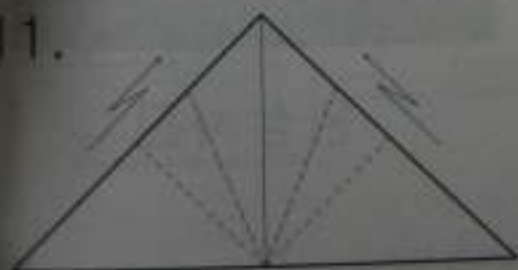

안으로 잘어넣는다
(12번처럼)

12.

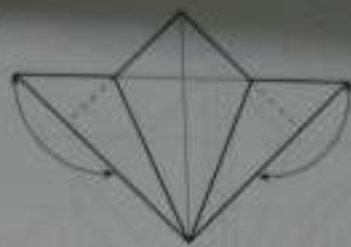

13.

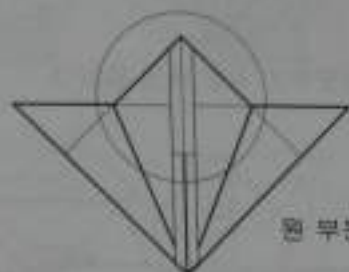

꼭꼭다 꺾다

14.

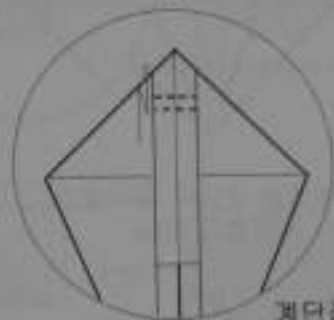

꼭꼭다 꺾다

15.



16.

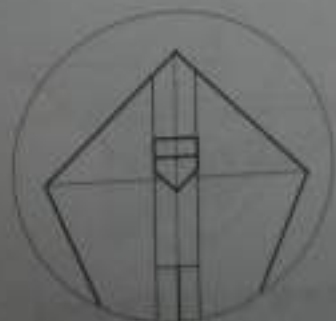

17.

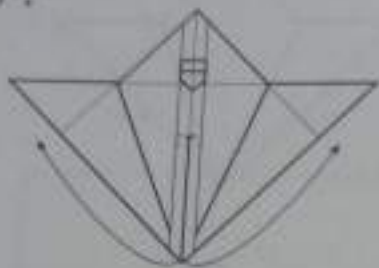

아랫부분 각을 위로 올린다

18.

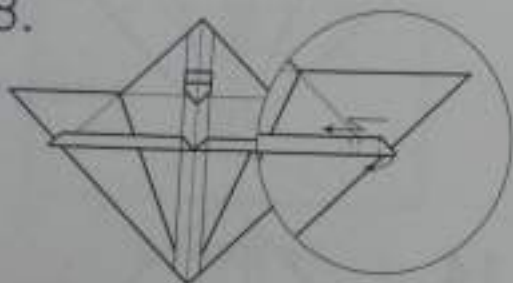

끝부분을 안으로 접어넣고
계단접기 한다

19.

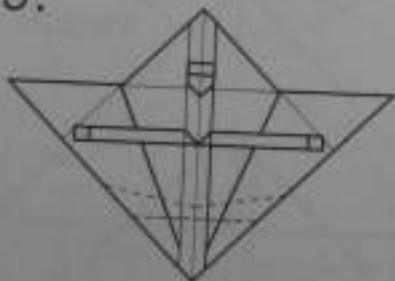

선대로 접는다

20.



윗부분을 안으로 접어넣는다

21.



윗부분을 눌러 넣는다
(스프레드 싱크)

22.

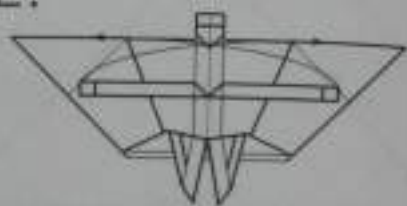

완성사진

자세한 내용은
<http://blog.naver.com/jr34>를 참고바랍니다

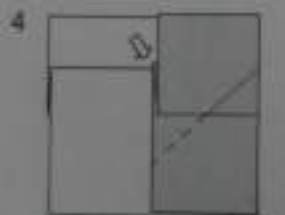
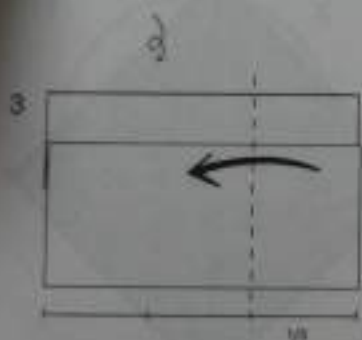
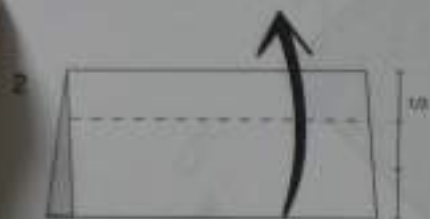
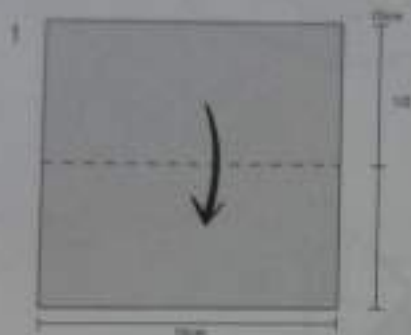

모기안틀 등을 잘라내기 잘라내주세요



3-4번 과정을 정확히 반복하세요

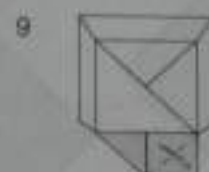
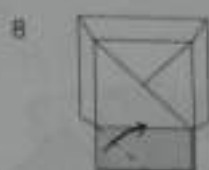
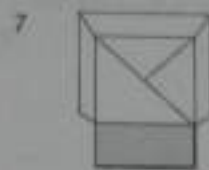

사이드 패널의 안쪽 끝이 밑으로 안착 될 때까지

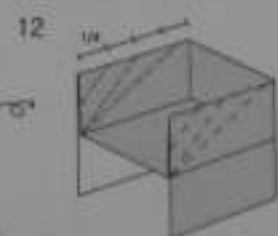

옆면 패널 안쪽 끝까지 잘립니다

13

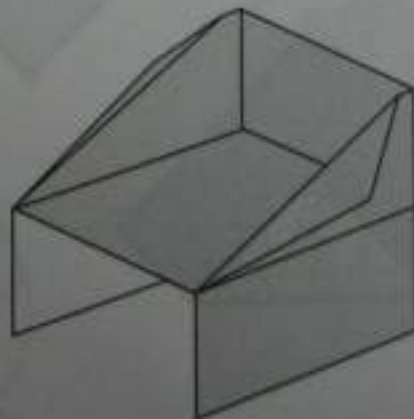

창 작 2005년 7월
도면제작 2008년 6월 14일

뚜껑 1

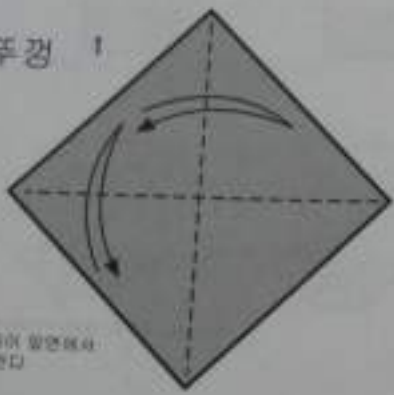

본 종이 앞면에서
시작한다

2

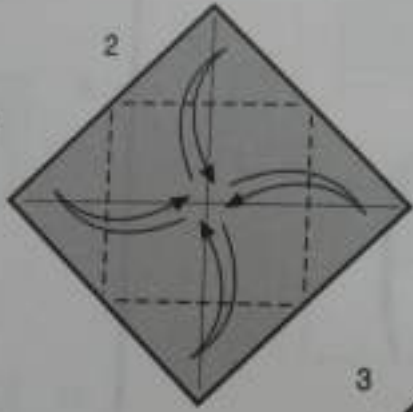

3

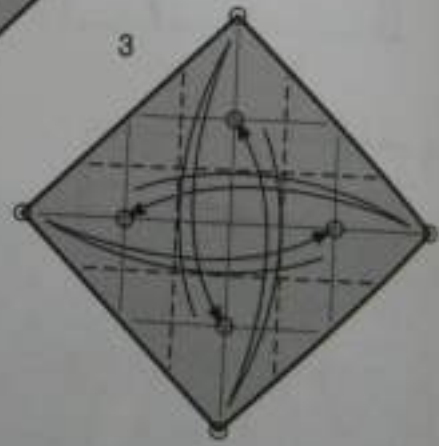

4

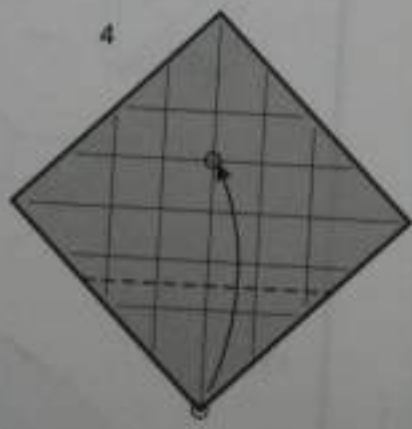

5

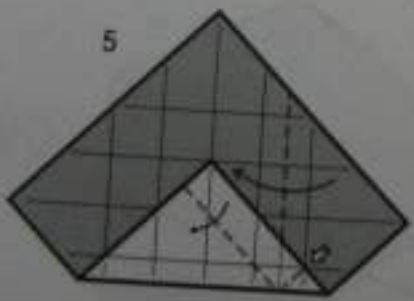

6

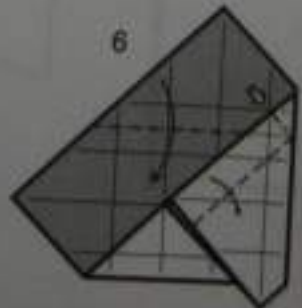

7



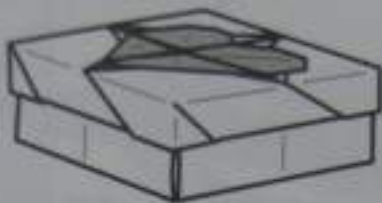

반쪽만 잘라내거나
기본모양을 사용한다.
반쪽 크기는 0.5cm 작게 하거나 크
문을 살짝 높이면 잘 들어간다.

하트 상자 완성

15



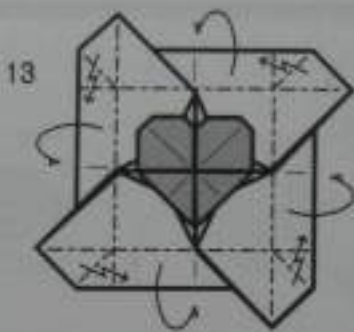

14



12

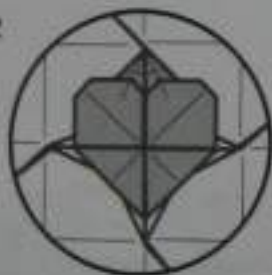

11

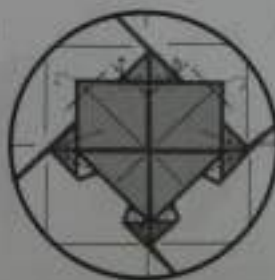

10

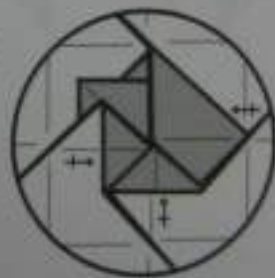

9



8



전투기

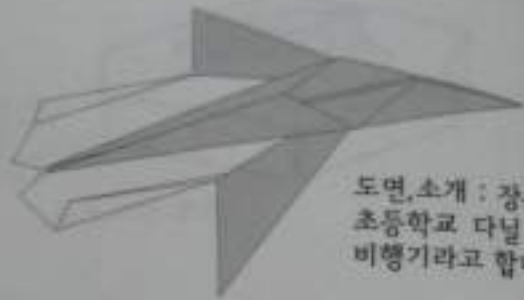

도면, 소개 : 장은수
초등학교 다닐 때 접었던
비행기라고 합니다.

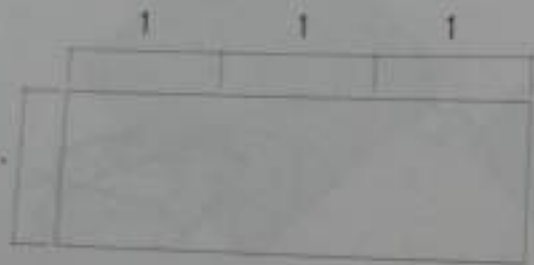

Size Sheet 15cmX 5cm

1.

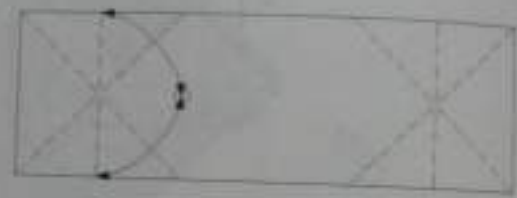

2.



3.



4.

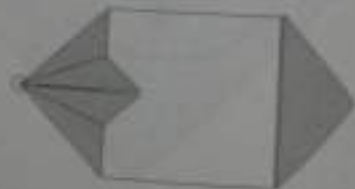

5.



6.

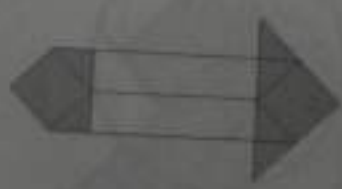

7.



8.

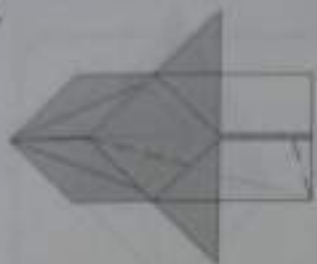

9.

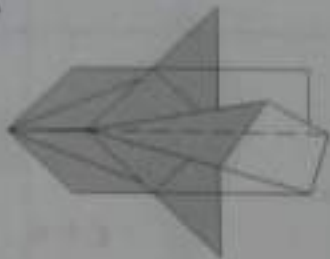

10.

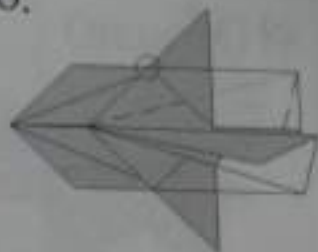

8~9반복접기

11.

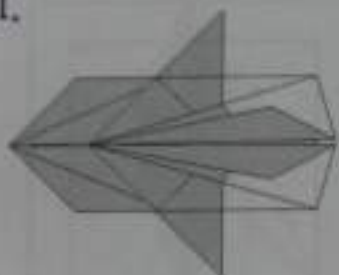

12.

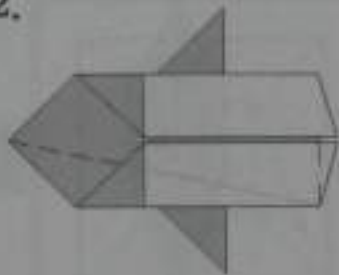

13.

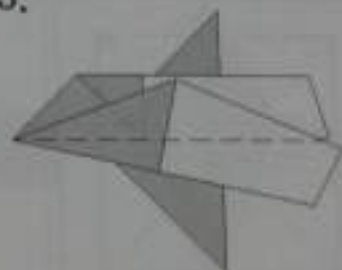

10~11반복접기

14.

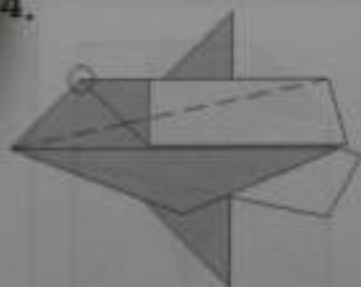

15.

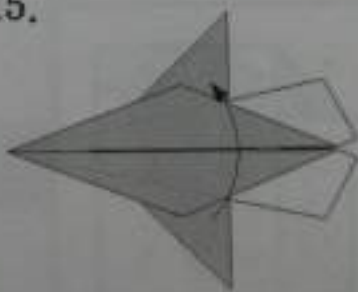

16.



17.

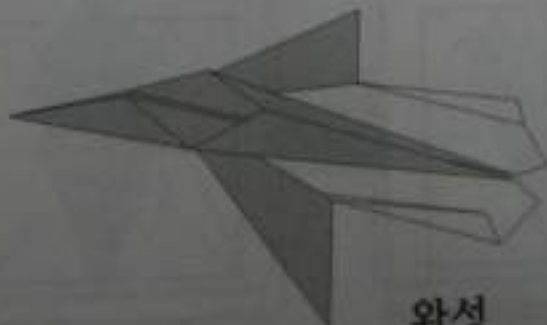
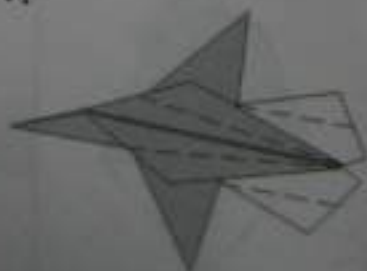

완성

쥐 (Mouse)



● 창작 : 조성범

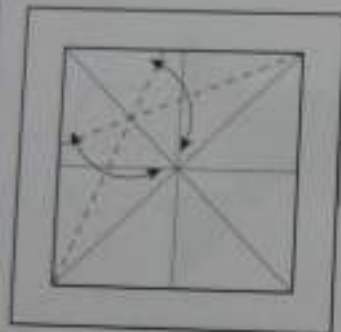

1. 선을 따라 접기선을 만드세요.

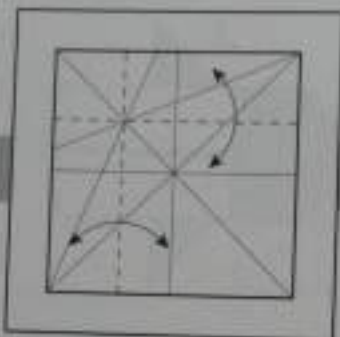

2. 선을 따라 접기선을 만드세요.

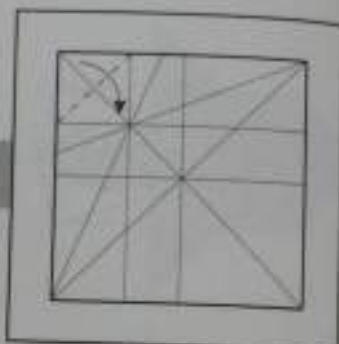

3. 교차점에 맞춰 접으세요.

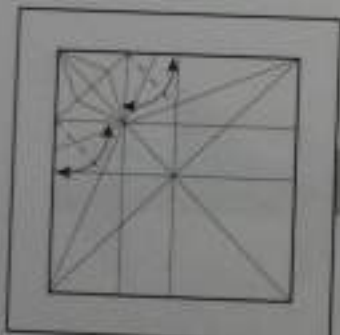

4. 선을 따라 접기선을 만드세요.

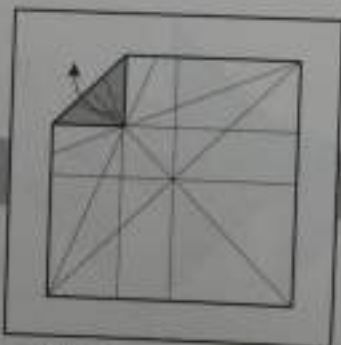

5. 접으세요.

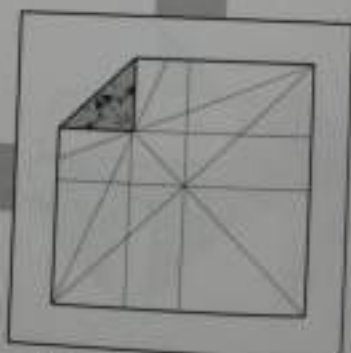

6. 선을 따라 접기선을 만드세요.

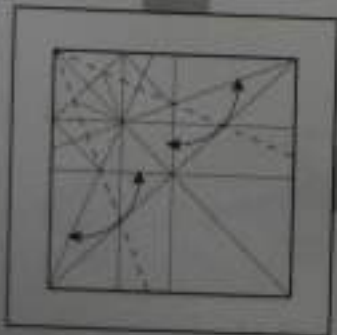

7. 중심선에 맞춰 접기선을 만드세요.

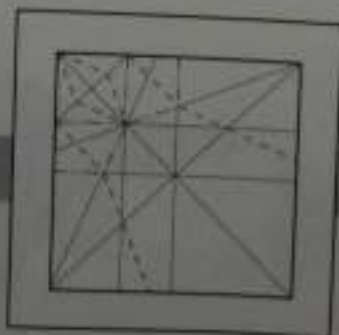

8. 선을 잘 보고 따라 접으세요.

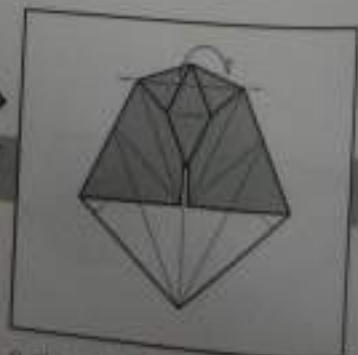

9. 뒤로 접으세요.

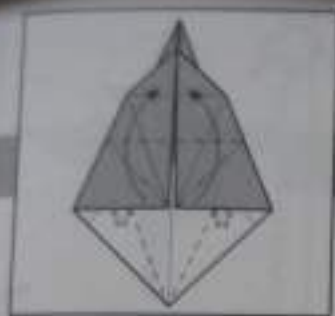

10. 위도 펼쳐 눌러 접으세요.

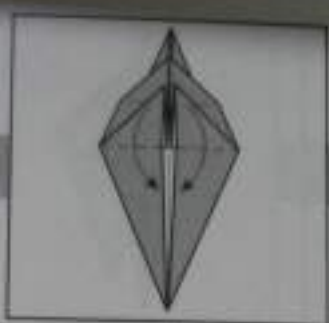

11. 밑으로 내리세요.

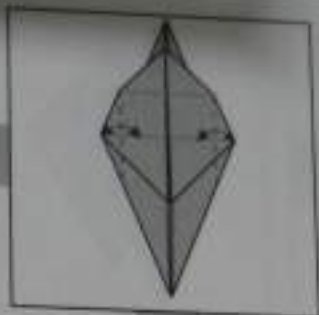

12. 선을 만드세요.

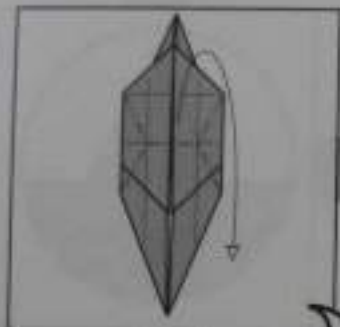

15. 상단을 안으로 넣어 접고
뒤로 접으세요.

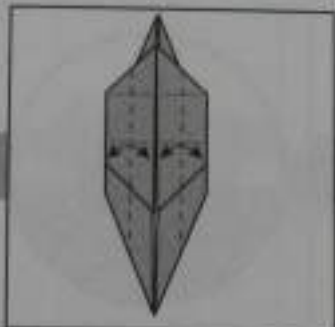

14. 중심선에 맞춰 접기선을
만드세요.

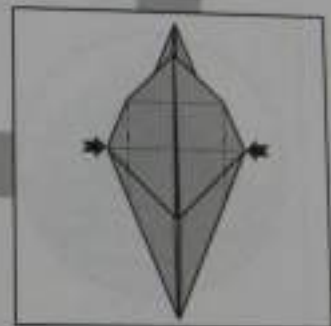

13. 안으로 밀어 넣으세요.
(open skin)



16. 비스듬히 접으세요.

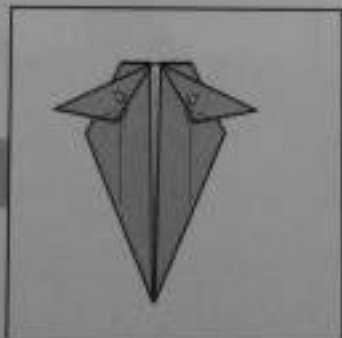

17. 모서리를 접으세요.

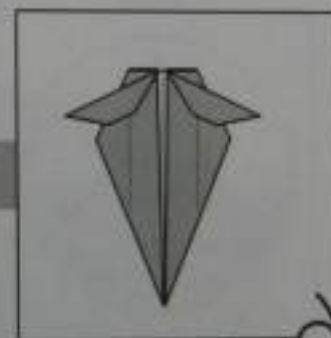

18. 미접으세요.

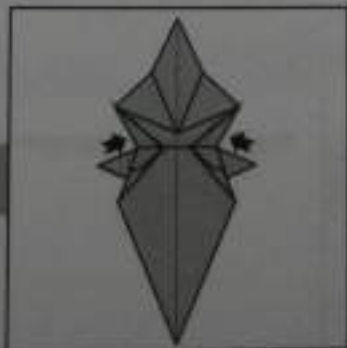

20. 위상과 꼭짓점을 안으로

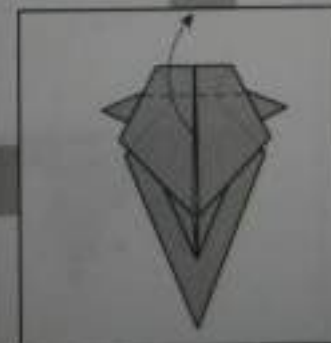

19. 위도 돌려접으세요.

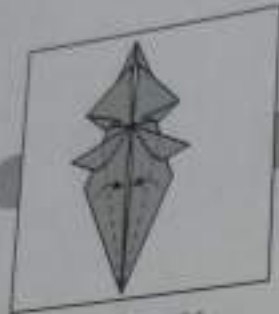

21. 꼭꼭에 맞춰 접으세요.

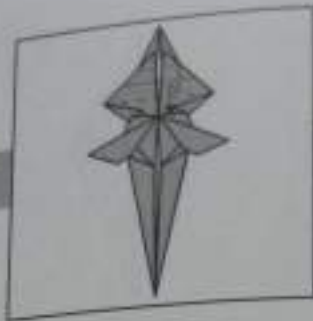

23. 계단 접기 하세요.



24. 부분 확대

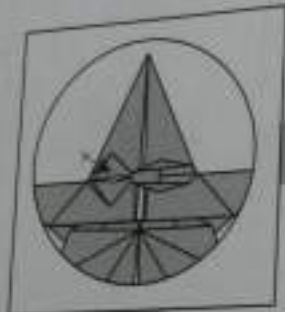

27. 반대쪽도 같은 방법으로 접으세요.

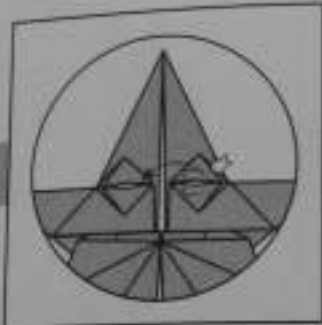

28. 펼쳐놓아 접으세요.

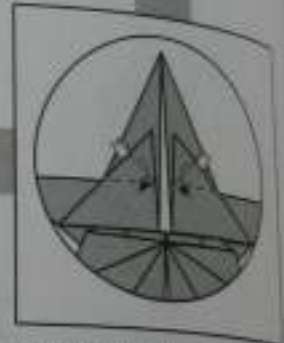

29. 펼쳐놓아 접으세요.

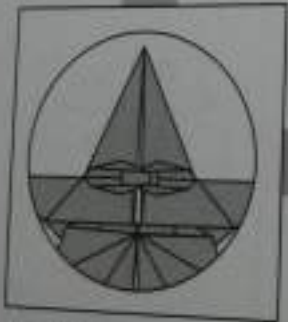

30. 귀 완성.

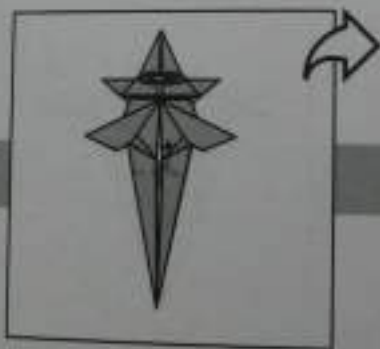

31. 계단 접기 해서 안으로 넣으세요.



32. 꼬리할 가늘게 되도록 접으세요.

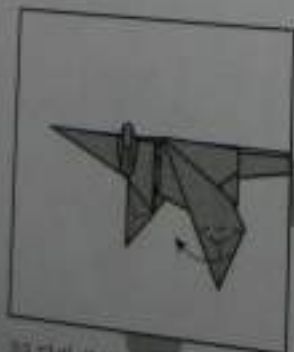

33. 다의 부분을 한꺼번에 부풀려 주세요.

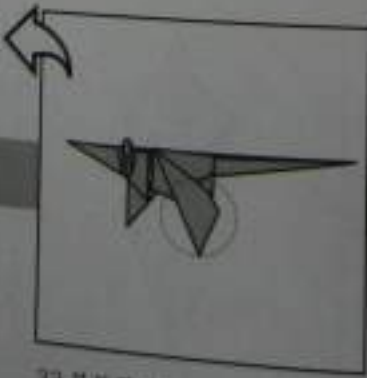

34. 부분 확대



35. 반으로 접으세요.

2008년 한국종이접기컨벤션 창작작품모음집

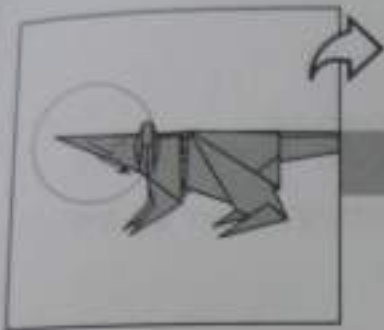

34. 부분확대(머리부분)

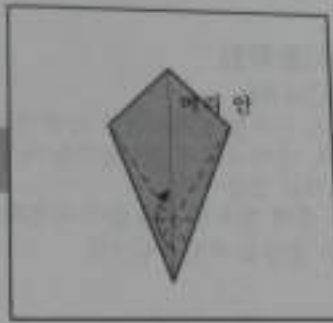

35. 좌우접기를 하세요.

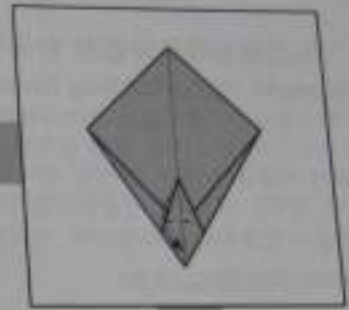

36. 반으로 접으세요.

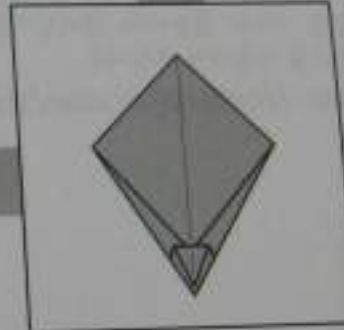
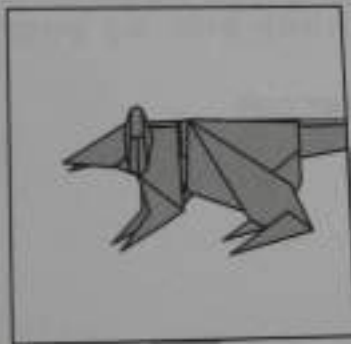

37. 입완성.

완성

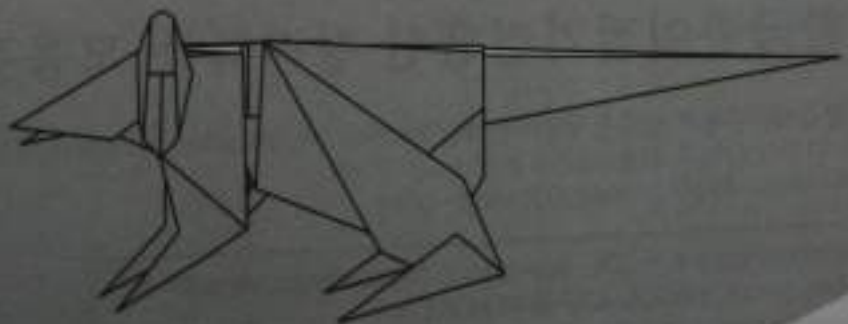

2008년 한국종이접기컨벤션 창작작품모음집

(사)전통공예문화협회 한국창작종이문화원

Korean Paperfolding Research Center

한국창작종이문화원은 우리나라의 종이접기 문화를 발전시키기 위해 설립된 단체입니다. 전국 70여개 지부를 통해 유치원, 초등학교, 중학교에서 종이접기를 지도하는 한편, 국내외 창작자를 지원하여 작품을 발표할 수 있는 전시회를 개최하고 있습니다. 이 책에는 2008년 한국종이접기컨벤션을 통해 발표된 작품들이 수록되었습니다. 앞으로 보다 많은 창작 작품이 발표되기를 기원하며, 여러분의 많은 관심을 부탁드립니다.

www.ifolding.or.kr

네이버종이접기카페

국내 최대 규모의 종이접기 카페로 58,000명 이상의 회원들이 종이접기, 종이로봇 등에 대한 정보와 의견을 나누고 있습니다. 종이접기를 처음 시작하는 분이나, 고급 종이접기를 배우고 싶은 분들은 언제든지 이곳을 방문하여 주십시오.

<http://cafe.naver.com/yortpaper.cafe>

2008 한국종이접기컨벤션 창작작품 모음집

발행 (사)전통공예문화협회 한국창작종이문화원 Korean Paperfolding Research Center

주소 경기도 안산시 단원구 와동 762 율동상가 1동 201호

Tel) 031-402-4540 Fax) 031-486-3046

Yulongsangga 1 - 201, Wa-dong, Danwon-gu, Ansan-Si,

Kyeonggi-do, SEOUL 425-842 KOREA

Korean Paperfolding Research Center

Tel) 031-402-4540 Fax) 031-486-3046

편집 신한국 Shin, Hae-Gyo

표지디자인 최나리 Choi, Na-Ri

발행일 2008년 7월 1일

정가 5,000원

◎ 각 작품의 권리는 작품의 창작자에게 있습니다.

※ 이 책의 수익금 중 일부는 종이접기 창작자들의 활동에 지원됩니다.



D i n o R i d e r

2008년 종이접기 컨벤션북

