

ORIGAMI  
chile

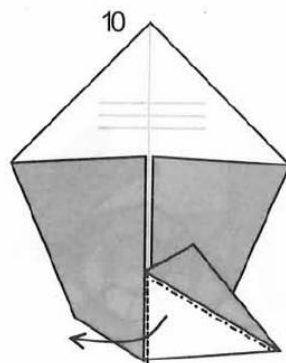

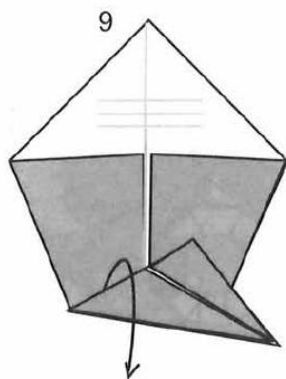

Repetir el paso  
12 al otro lado

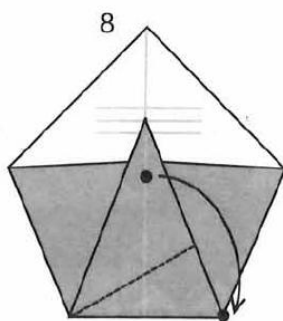
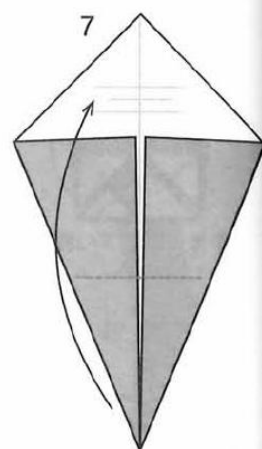
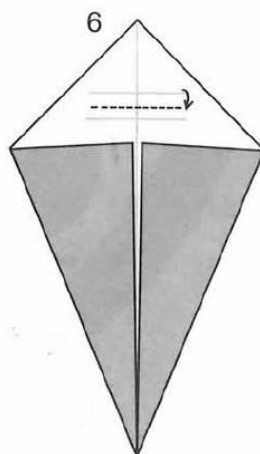
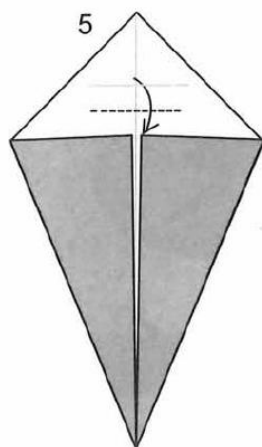
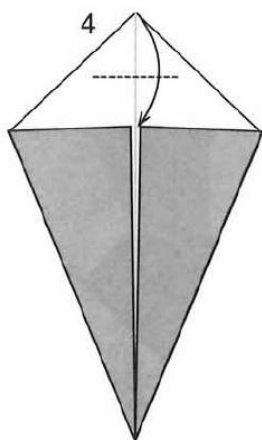
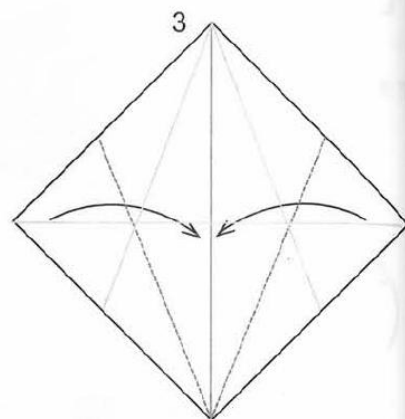
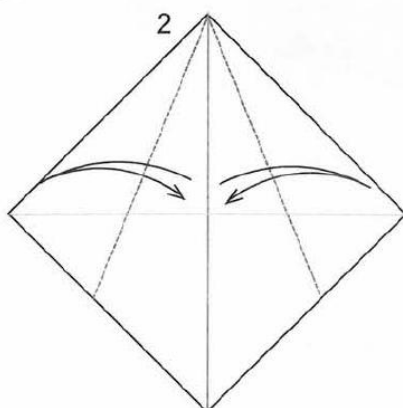
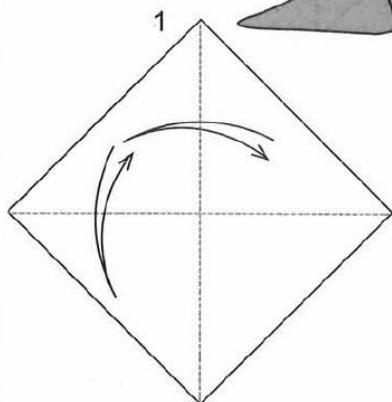
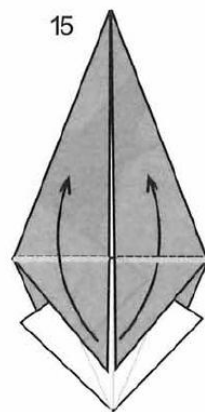
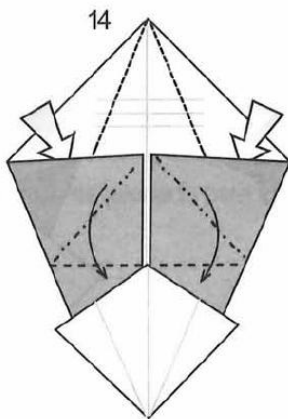
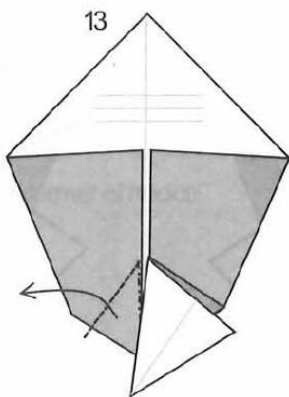
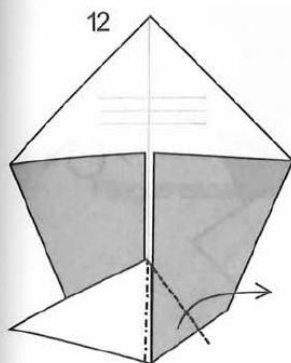
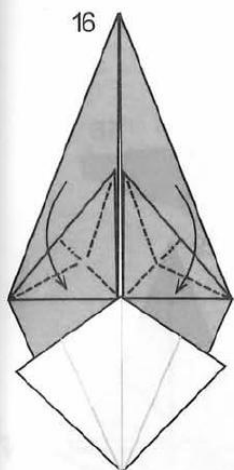

Doble oreja de  
conejo

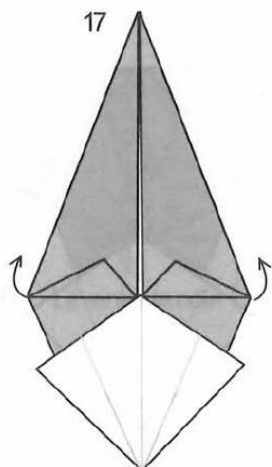

Despalzar hacia  
arriba

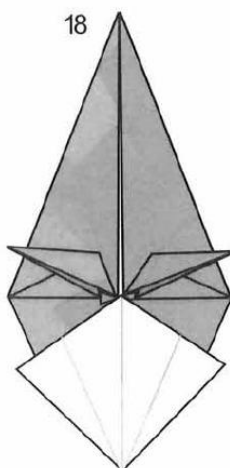

Despalzar hacia  
arriba

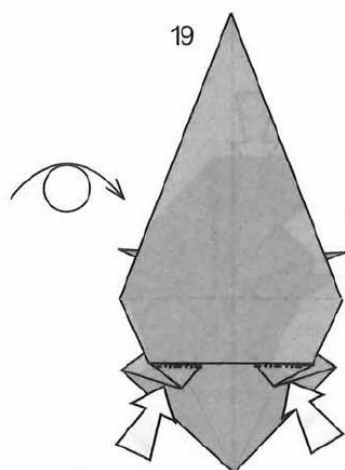

Hundir

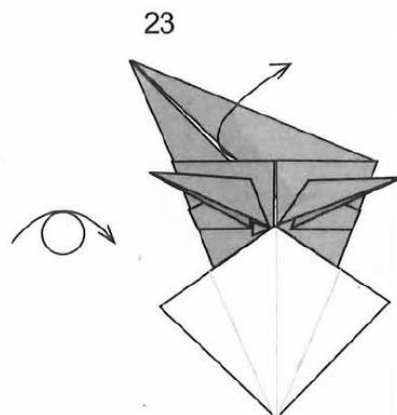
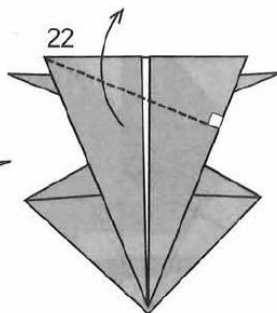
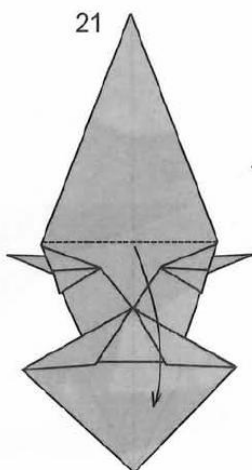
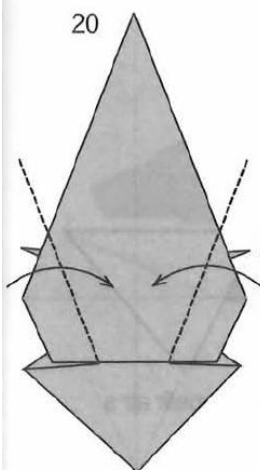

23

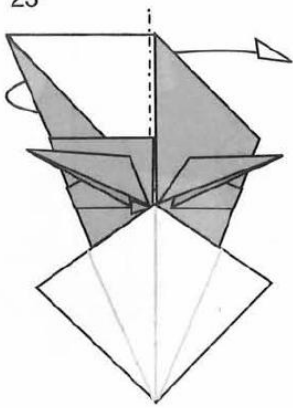

24

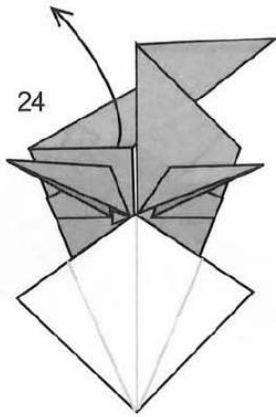

25

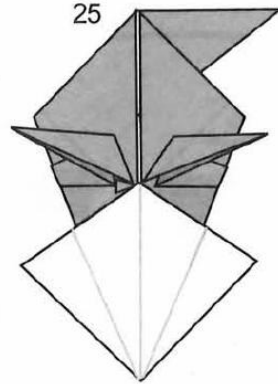

27

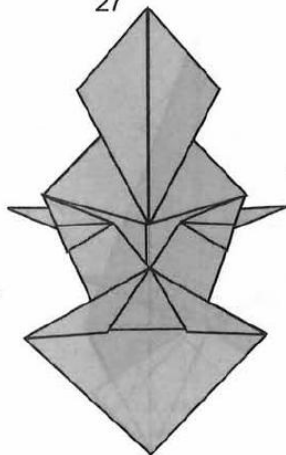

26

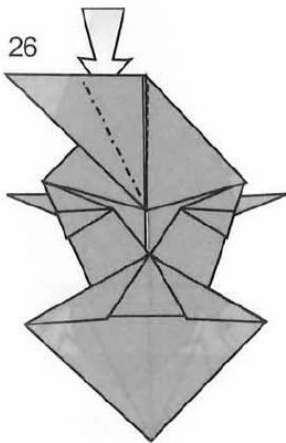

28

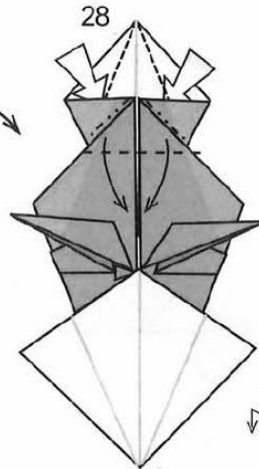

29

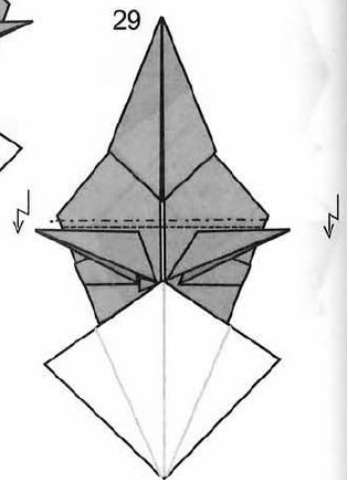

30

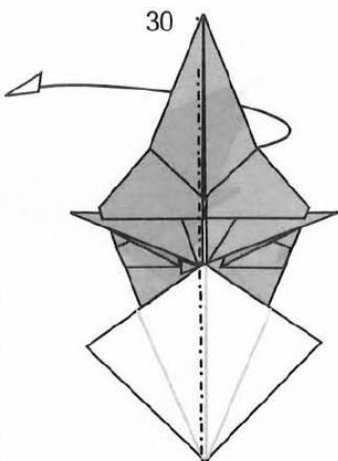

31

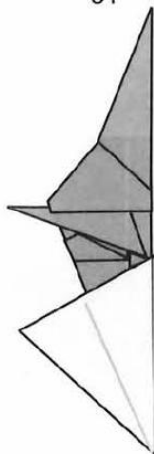

32

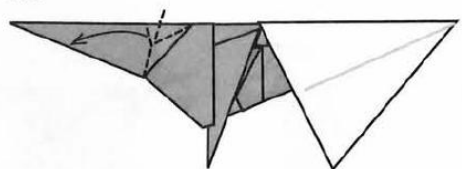

Oreja de conejo, repetir atr-s

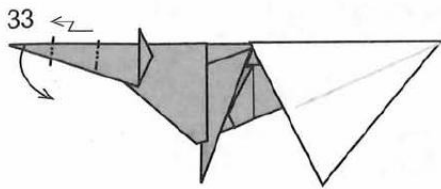

33 Pliegue escalonado para formar el hocico

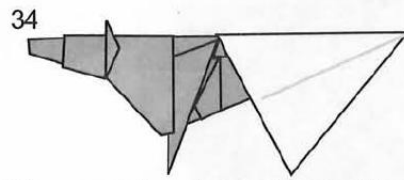

34 Pliegue escalonado para formar el hocico

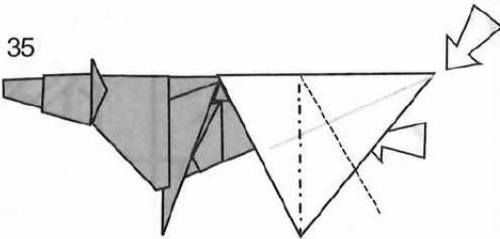

35 Hundir la cola

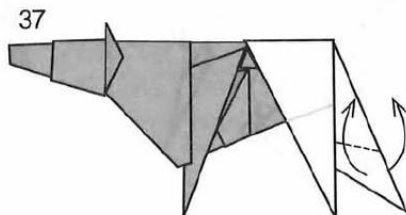
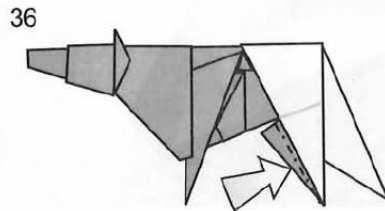

37 Levantar la cola

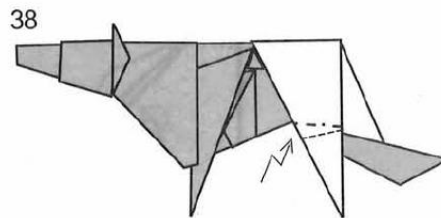

38 Marcar patas trasera

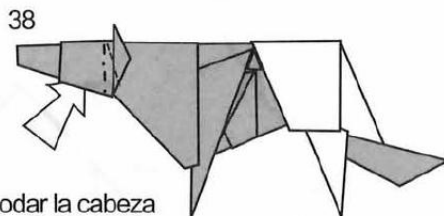

38 Acomodar la cabeza

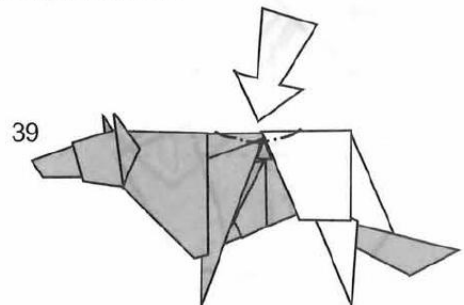

39 Dar volumen a la figura

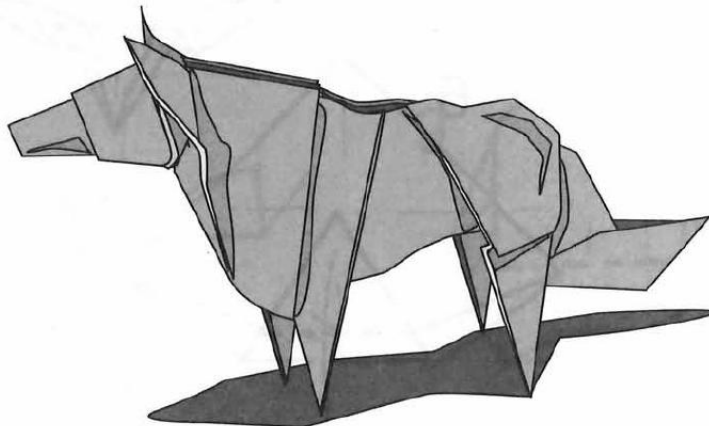

ORIGAMI  
chile

[www.origamichile.cl](http://www.origamichile.cl)