

\$ Heart-and-Arrow

Copyright 1999 Stephen Hecht. All Rights Reserved

A dollar bill makes a model 30 mm x 45mm. For your first attempt, begin with a 3x7 rectangle larger than a dollar bill.

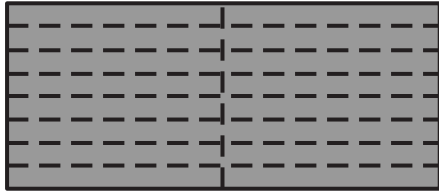

1. Either side up. Crease at eighths horizontally, halfway vertically. Flex all creases both ways.

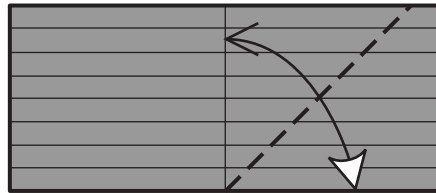

2. Make this crease sharp only where it crosses the center horizontal line.

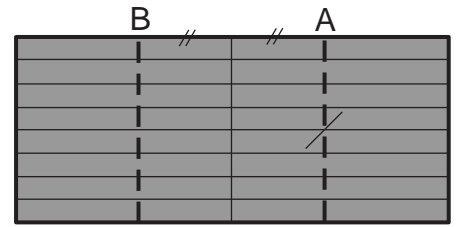

3. Use the mark to make crease "A". Then use "A" and the center vertical line to make crease "B", at the same distance. Flex both.

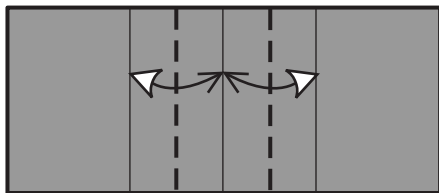

4. Horizontal creases not shown. Bisect the rectangles.

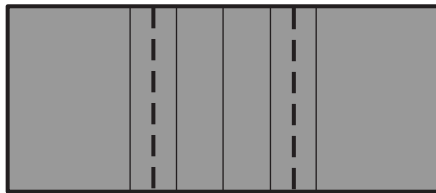

5. Bisect the outer rectangles.

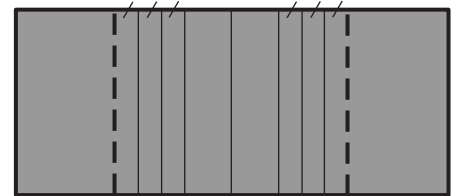

6. On each side, use the outer 2 creases to add another.

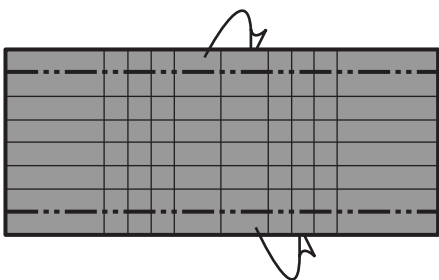

7. All creases shown. Mountain the top and bottom eighths behind.

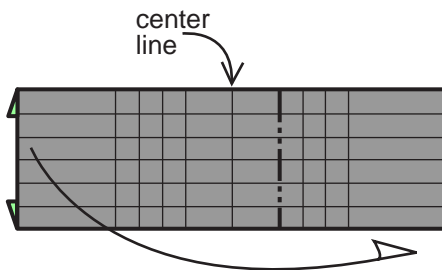

8. Swing behind on the indicated crease. Turn over.

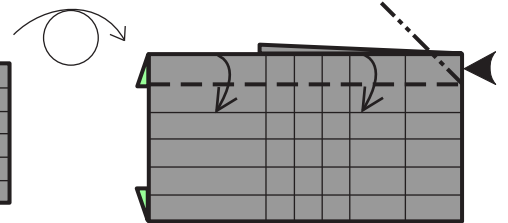

9. Flip down the top eighth, squashing the corner at the right.

\$ Heart-and-Arrow (cont.)

Copyright 1999 Stephen Hecht. All Rights Reserved

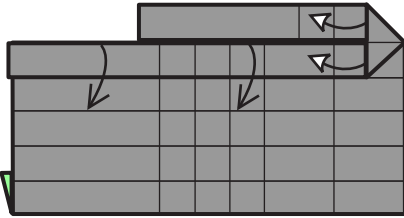

10. Pull out paper from under the squash, flipping down the long edge.

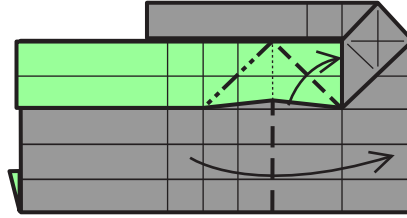

11. Swing over the long flap, while pulling up the triangle shown.

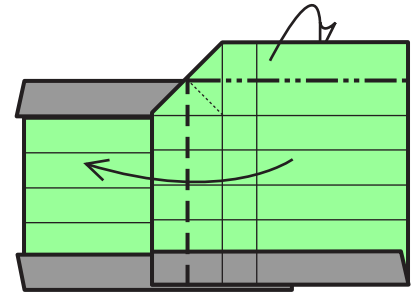

12. Swing flap back on existing crease, while flipping down the top eighth and squashing a tiny diagonal.

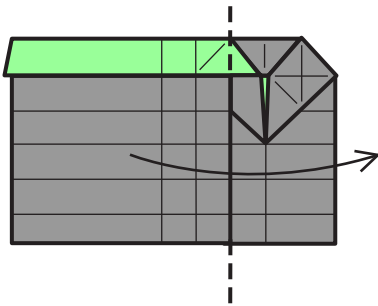

13. Swing back. Both sides of model will then look similar.

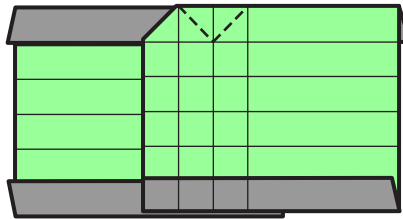

14. Crease.

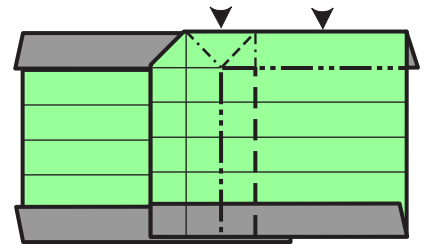

15. Pleat and sink on existing creases.

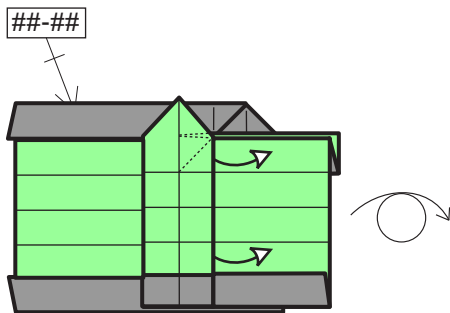

16. Undo last step. Turn over and repeat 14-16.

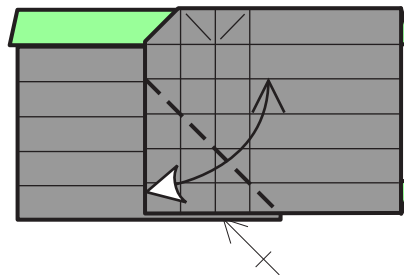

17. Crease top flap. Repeat behind.

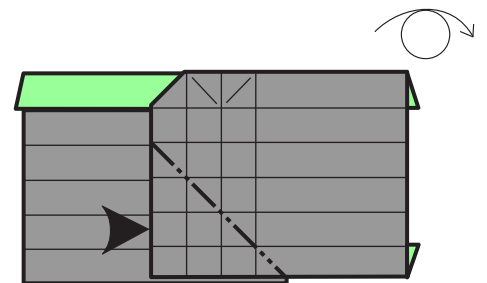

18. Reverse-fold on existing crease. Turn over.

\$ Heart-and-Arrow (cont.)

Copyright 1999 Stephen Hecht. All Rights Reserved

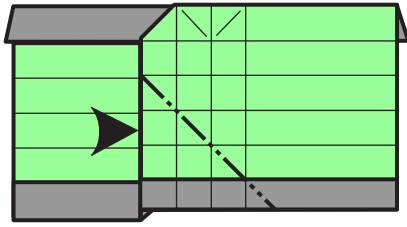

19. Reverse-fold on the crease; rear-half is double thickness.

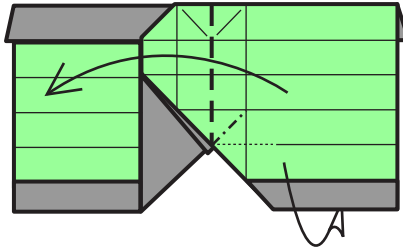

20. Swing flap to left on existing crease, squashing only the tiny diagonal indicated. The X-ray line is a hidden valley fold.

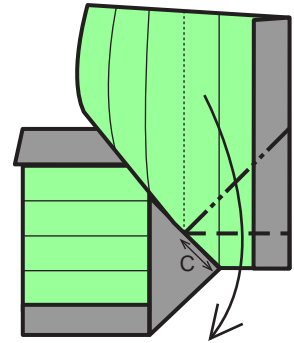

21. Segment "C" is the new crease. Swing back down on existing crease, squashing the diagonal shown. The X-ray line is a hidden valley fold.

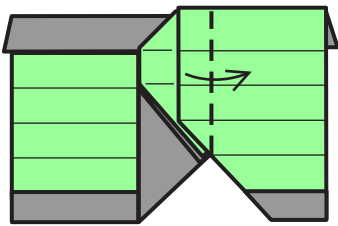

22. Fold the new flap to the right.

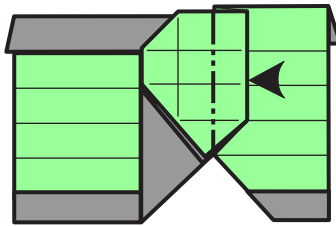

23. Reverse-fold at the top, closed-sink at the bottom.

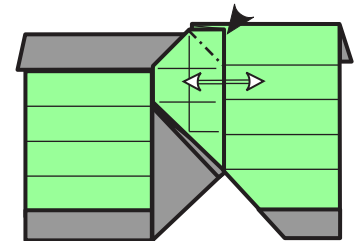

24. Pull gently open at the top, and reform the sink from step 15.

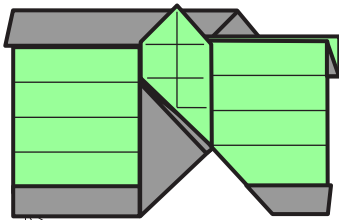

25. Repeat 20-24 behind.

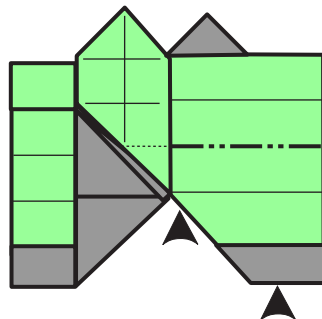

26. Reverse-fold. At the left end, only the embedded layer is reverse-folded.

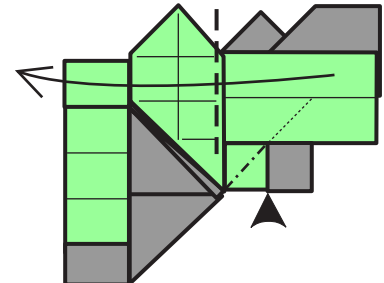

27. Swing flap to the left, squashing the corner behind it.

\$ Heart-and-Arrow (cont.)

Copyright 1999 Stephen Hecht. All Rights Reserved

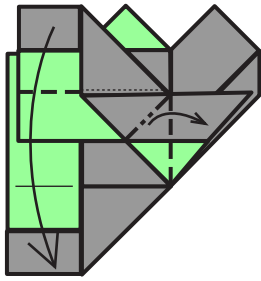

28. Swivel again. Note the tiny squash (mountain-fold).

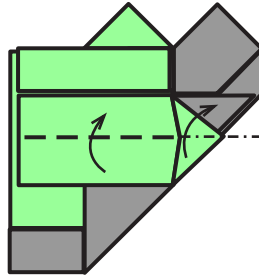

29. Flip up an edge, opening the triangular pocket.

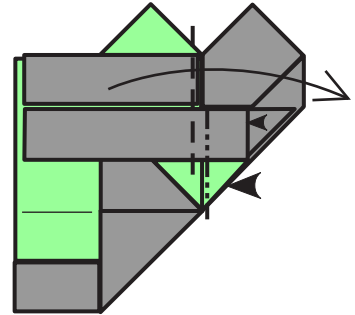

30. Closed-sink the small two-toned trapezoid. Then swing the pleated flap to the right.

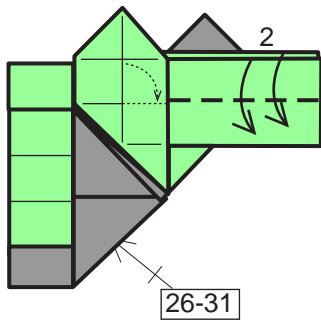

31. Swing down 2 edges, swiveling under the sunken area. Repeat 26-31 behind.

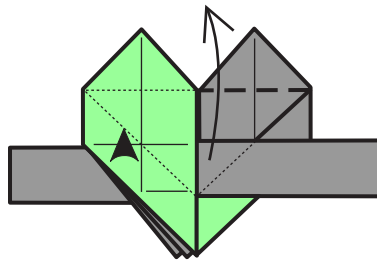

32. Swing the large, hidden triangular flap upwards, reverse-folding the left side.

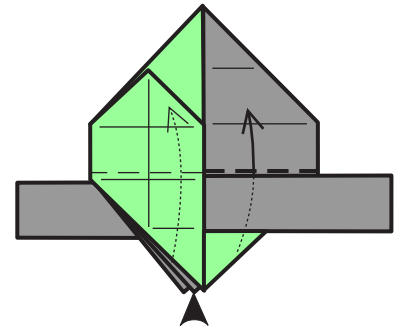

33. Reverse-fold the middle triangle upwards.

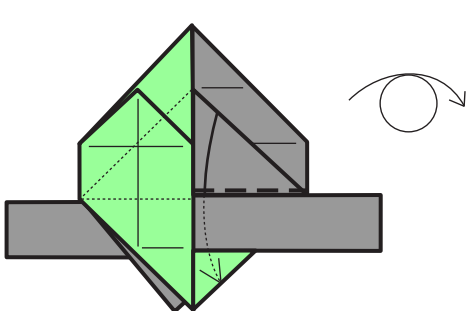

34. Valley-fold it back down, into the pocket immediately in front of it (a tight fit, even if accurate). Turn over.

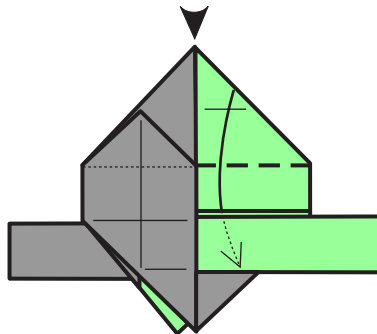

35. Reverse-fold the top point down, tucking the tip into the pocket immediately in front of it.

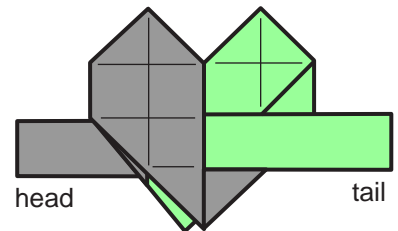

36. Like so. Now we begin on the tail of the arrow.

\$ Heart-and-Arrow (cont.)

Copyright 1999 Stephen Hecht. All Rights Reserved

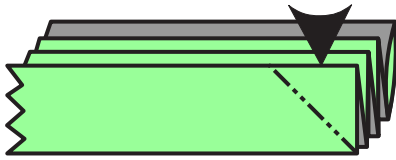

37. Tail: notice pleats are not perfectly symmetric. Reverse-fold.



38. (Not all edges shown.) Swing over.

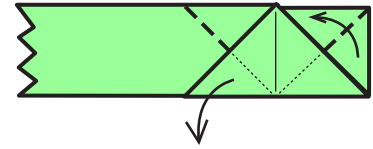

39. Rotate.

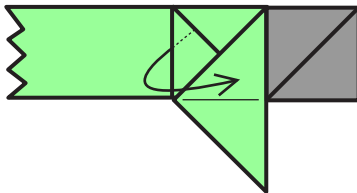

40. Bring one layer to surface (a closed-sink).

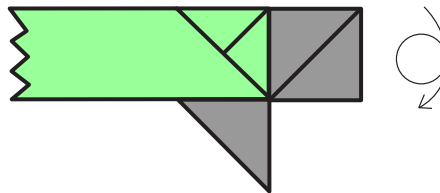

41. Thus. Turn model over top-to-bottom.

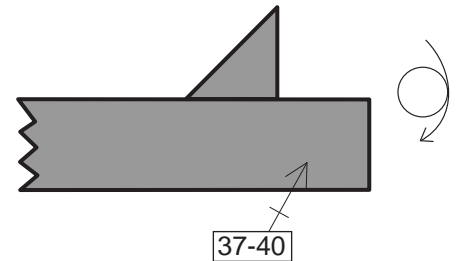

42. Repeat 37-40, treating the double-thickness as one layer. Turn back over (top-to-bottom).

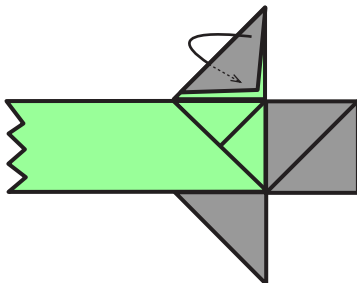

43. Tuck in the loose triangle.

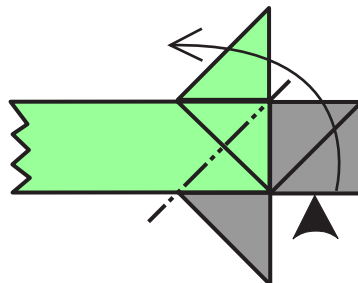

44. Reverse-fold protruding edges as if they were a single edge.

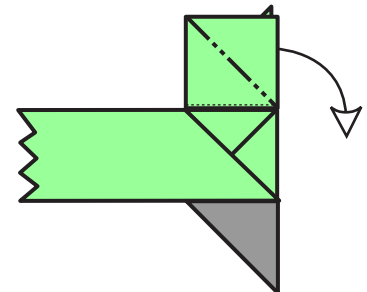

45. Pull out paper and swivel down the front edge. The X-ray line is a horizontal valley-fold that becomes a vertical mountain-fold flush with the right edge of the model.

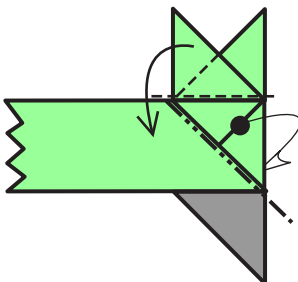

46. Swing the middle triangle down and behind, dragging the upper triangle.

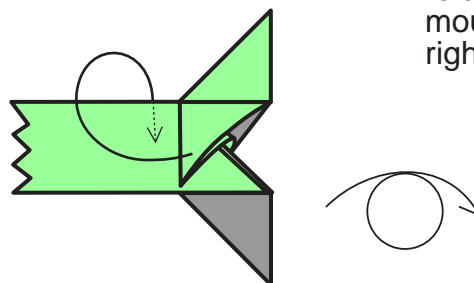

47. Tuck the loose triangle into the second pocket (between pleats, not into the sink). Tail complete. Turn over side-to-side.

\$ Heart-and-Arrow (cont.)

Copyright 1999 Stephen Hecht. All Rights Reserved

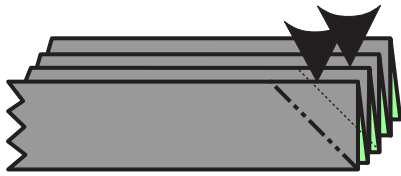

48. Head of the arrow.
Pleats are symmetric.
Reverse-fold first 2 corners.



49. (Not all edges shown.)
Swing 2 flaps to the left.

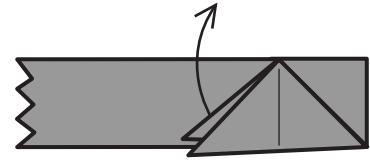

50. Pull out corner.

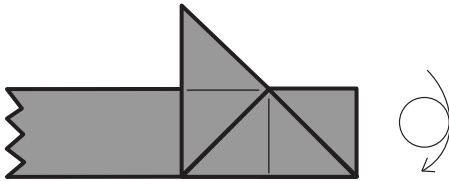

51. Like so. Turn over top-to-bottom.

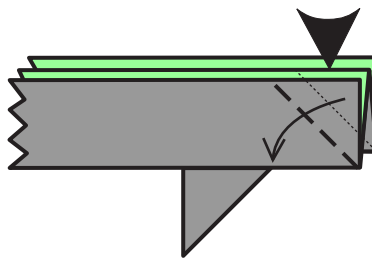

52. Valley-fold top corner.
Reverse-fold next corner.

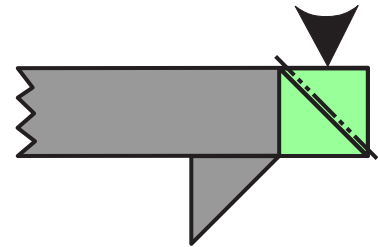

53. Reverse-fold the remaining corner; its rear half is smaller than its front.

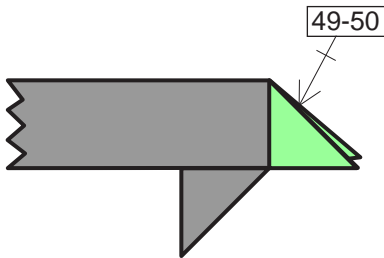

54. Repeat 49-50.

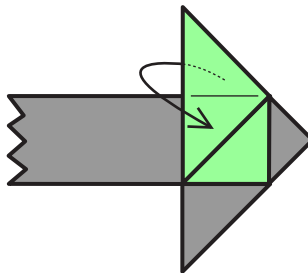

55. Swing rear half of large triangle to front.

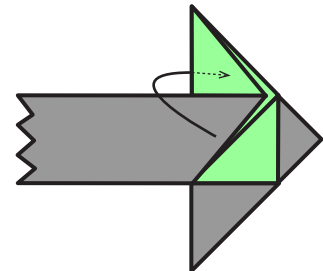

56. Tuck new flap into pocket behind. Front edges of arrowhead are now both closed.

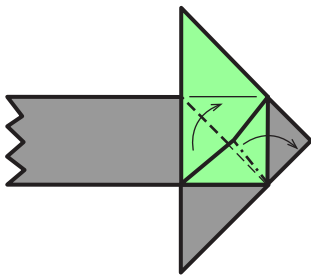

57. Squash. Turn over top-to-bottom and repeat on the other side.

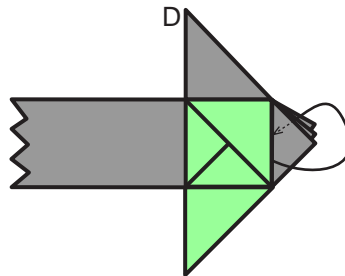

58. There are now 3 tiny triangular flaps at the tip. Wrap the top layer of the front triangle to its back. Very hard! Unfold point D and 3 pleats of the shaft while executing.

\$ Heart-and-Arrow (cont.)

Copyright 1999 Stephen Hecht. All Rights Reserved

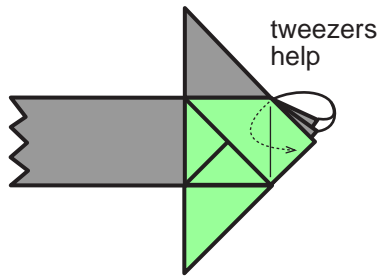

59. Tuck the middle and rear points inside the front point (sequentially or nested). Arrowhead complete.

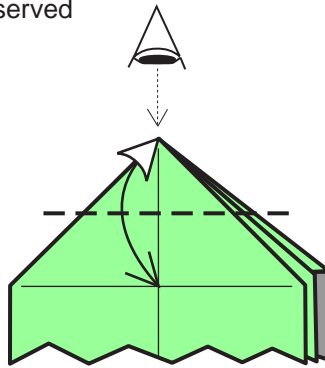

60. Left upper point of the heart. Crease and flex. Then open out the tip into a 3-sided pyramid, the 2 front right edges kept together.

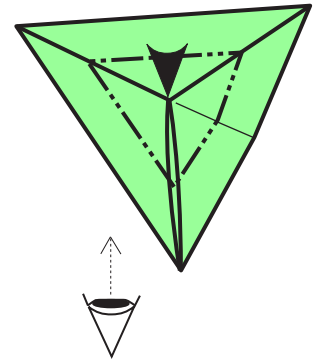

61. Top view. Sink the tip on the crease just made (keeping the double-edge together).

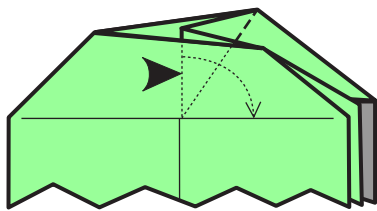

62. Back to a front view. Reverse-fold nested corner down.

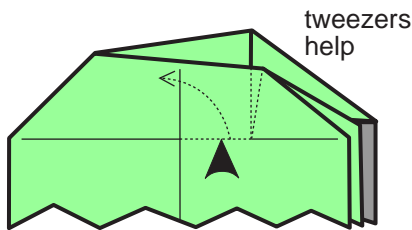

63. Reverse-fold the corner back up, tucking into the tiny pocket. These steps achieve a closed sink more easily. Repeat 60-63 on the right point of the heart.

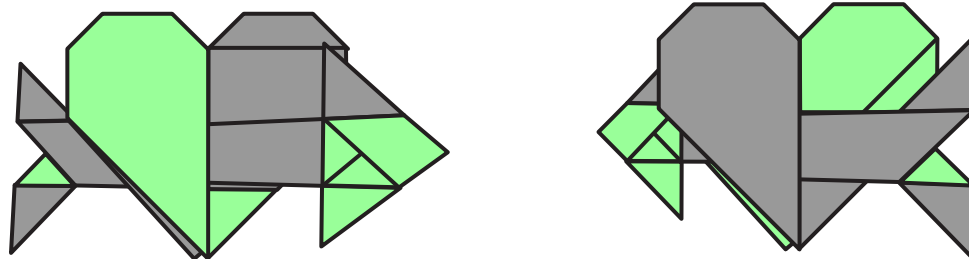

64. Model complete. Bend arrow head and tail outwards where they emerge from the heart.

There are unfortunately 2 separate points at the bottom of the heart, but this does help the model stand up a little better. And though I regret the two-tone harlequin-esque finish, it's not as glaring with a real dollar bill as in these diagrams. (I regard these shortcomings as the price of achieving my self-imposed goal: the arrow shaft emerges from under the planes of the heart.)