

Symbols



Push



Rotate



Change viewpoint

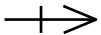

Repeat

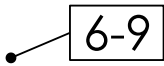

Repeat a range of steps



Right angle

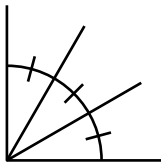

Dividing angle

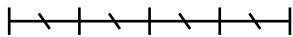

Dividing length

Techniques

Change Viewpoint

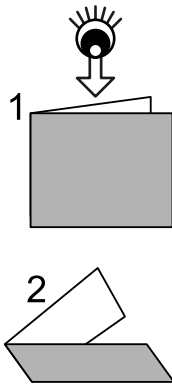

Squash-fold

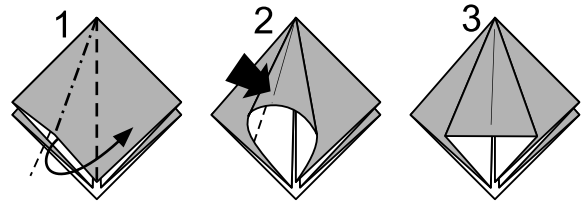

Petal-fold

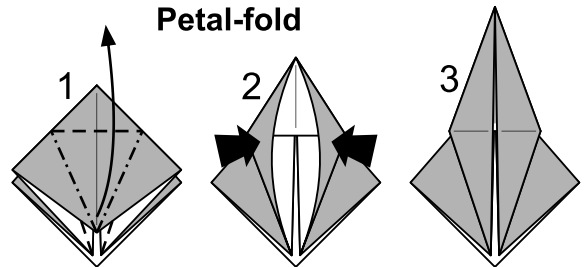

Rabbit-ear

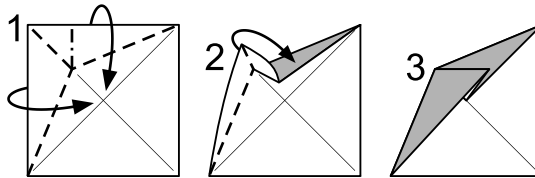

Rotation

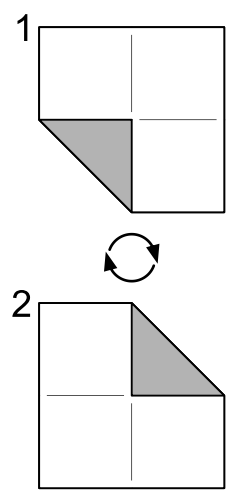

Double rabbit-ear

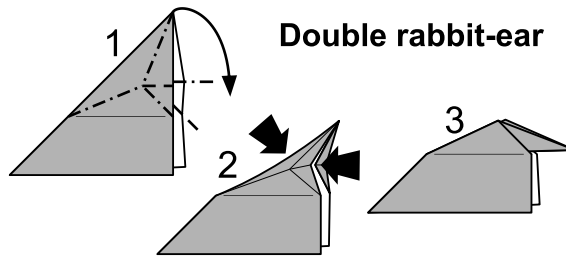

Dividing length

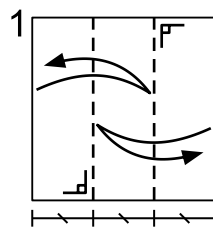

Repeat

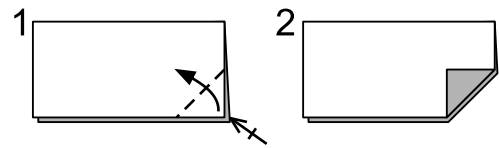

Dividing angle

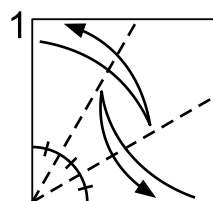

Repeat a range of steps

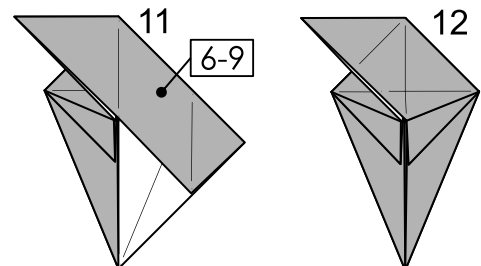

Techniques

Crimp inside

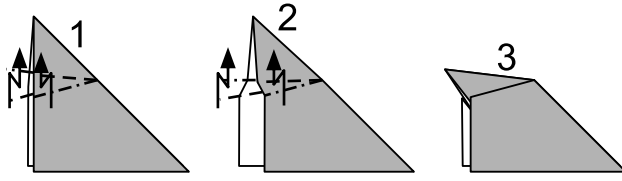

Crimp outside

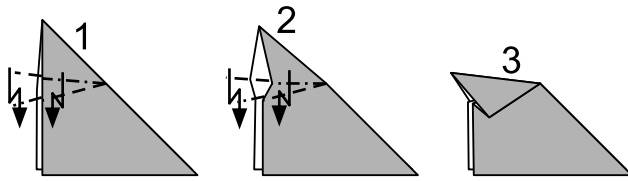

Crimp and sink

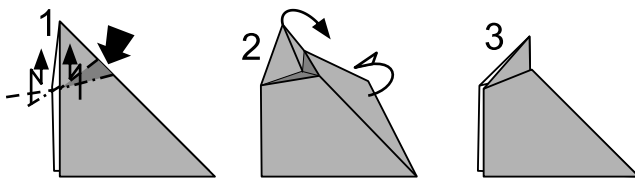

Spread sink

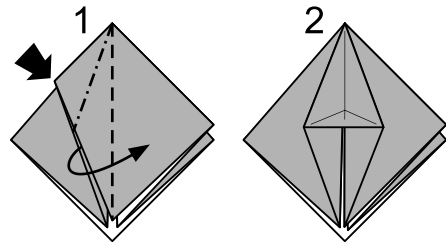

Swivel-fold

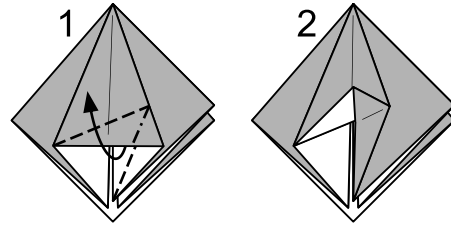

Inside swivel-fold

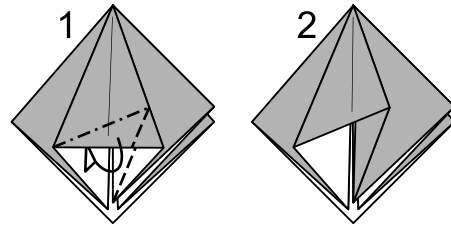

Open sink

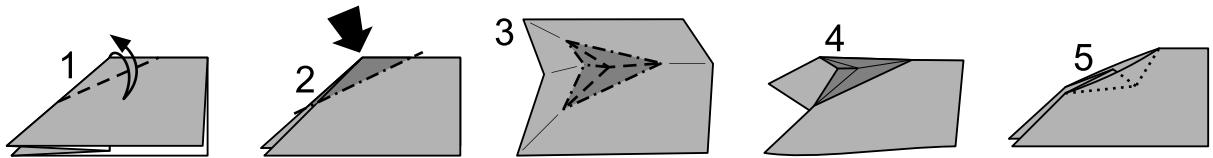

Closed sink

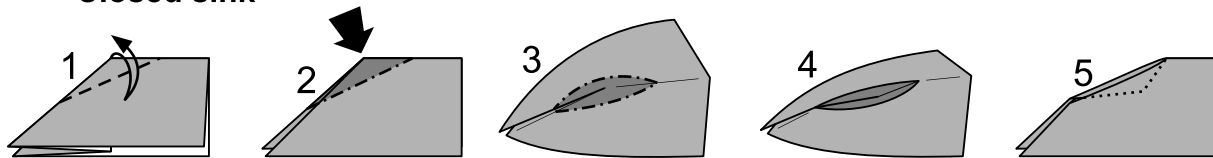

Open sink in and out

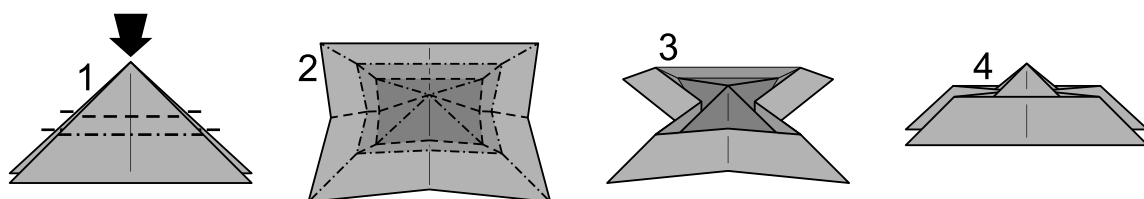

Bases

Fish base

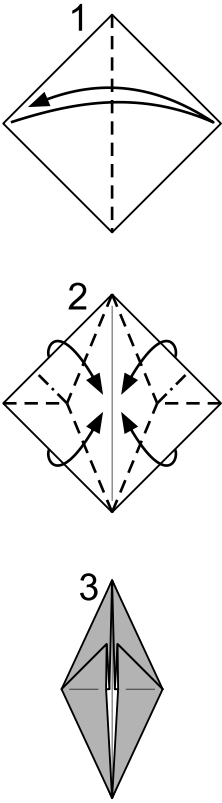

Water-bomb base

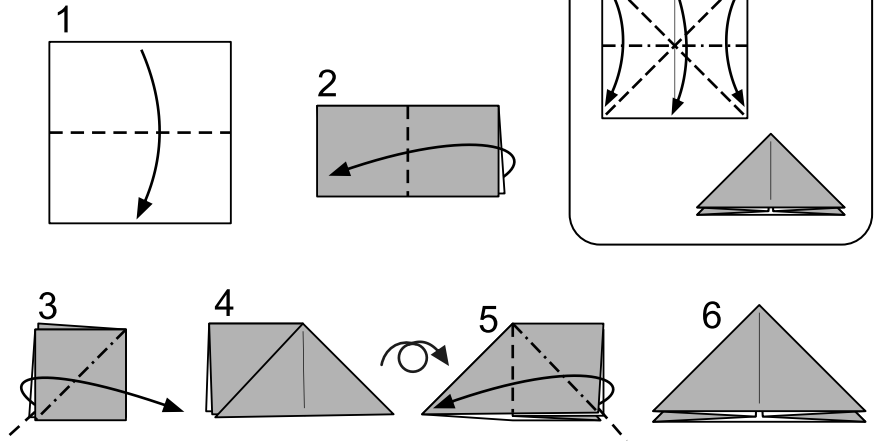

Preliminary base

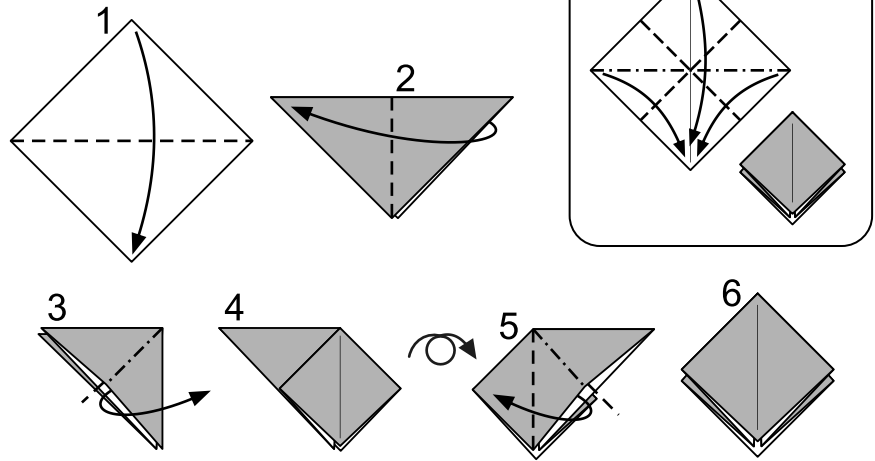

Bird base

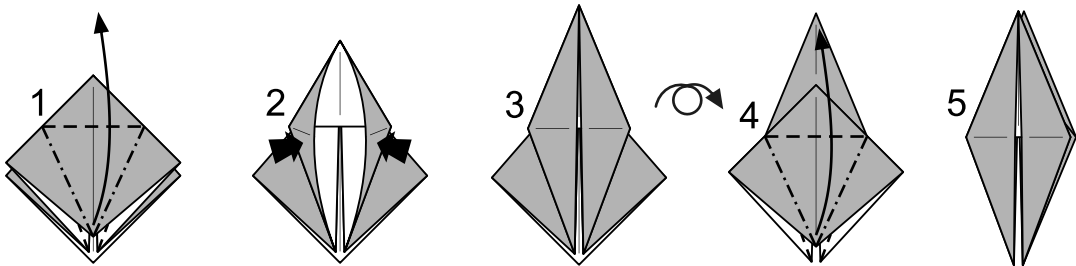

Frog base

