

Heart Warming Life Series

UNIT

POLYHEDORON

ORIGAMI

TOMOKO FUSE

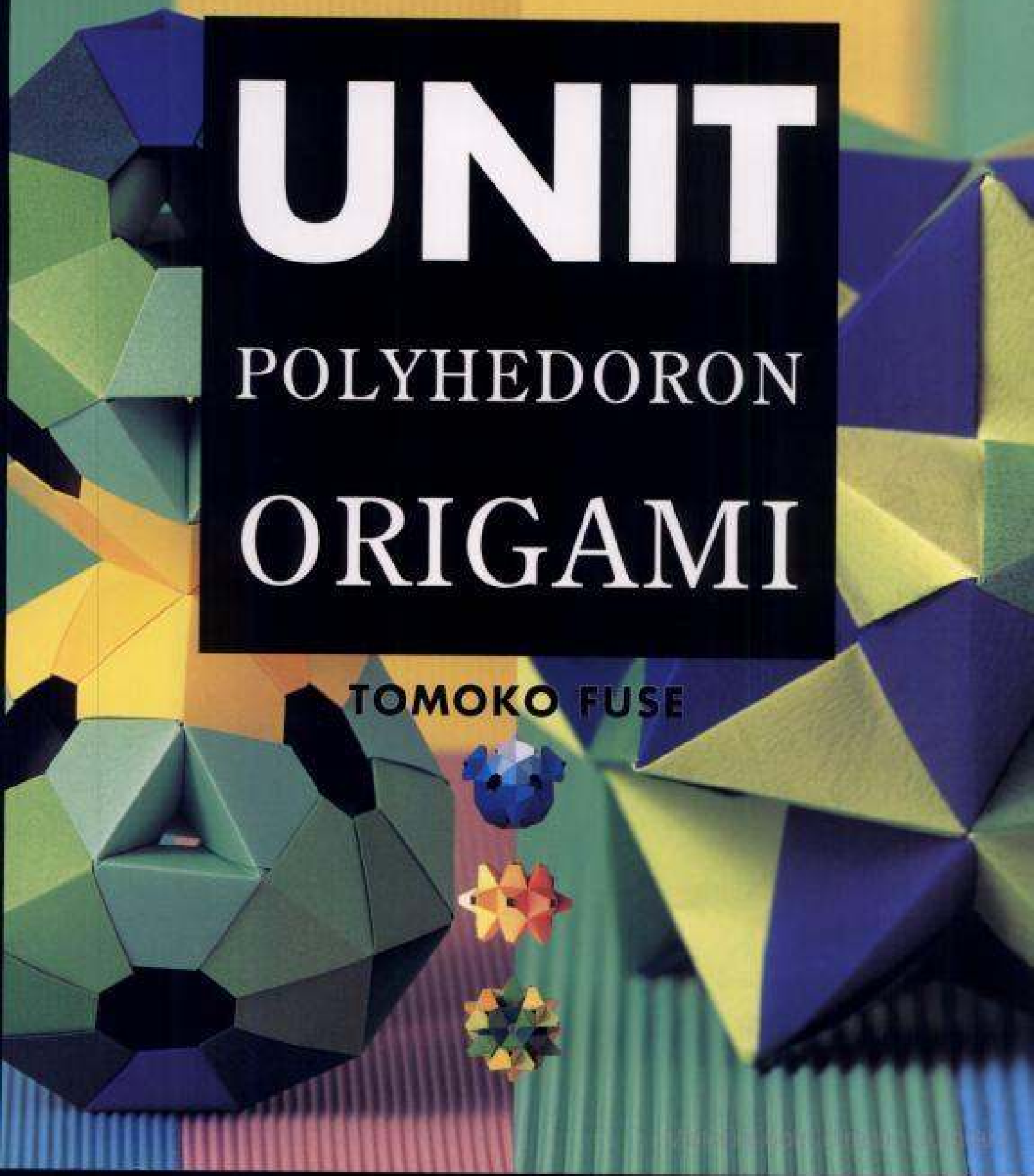

Preface

Unit origami is a method of producing various forms by assembling different numbers of prepared units. This book is intended to make polyhedrons. Polyhedrons sound difficult, but they are easy. You will come to understand what I mean as you fold these figures. Creating polyhedrons will become second nature to you. That is the power of origami.

Basically, no glues or other adhesives are used. Therefore at times some assemblies may be unstable. If you wish to use them as decorations for a long time, glue them. What is fun is in the process of folding. You will find many kinds of enjoyment in the process. Seeing your completed works will be an exciting discovery. It is my hope to share the joy and pleasure with you through this book.

Tomoko Fuse

Born in Niigata Prefecture. In her childhood, she first took up origami while hospitalized. She has held a number of exhibitions, including "Origami Paris" (1998) in France, "On Paper" (2001) in England, and a one-man exhibition in Bauhouse in Germany in 2004.

She is the author of about 60 origami books in English, German, Italian, and Korean.

©2005 by Tomoko Fuse

All rights reserved, including the rights to reproduce this book or portions thereof in any form without the prior written permission of the publisher.

Translated by Kazuhiko Nagai and Karen Sandness

©2006 English tex., Japan Publications Trading Co., Ltd.

English edition by Japan Publications Trading Co., Ltd.

1-2-1, Sarugaku-cho, Chiyoda-ku, Tokyo 101-0064, Japan

Original Japanese edition published by Nihon Vogue Co., Ltd.

3-23, Ichigaya Honmura-cho, Shinjuku-ku, Tokyo 162-8705, Japan

First edition, First printing : July 2006

Distributors:

United States: Kodansha America, Inc. through Oxford University Press,

198 Madison Avenue, New York, NY 10016.

Canada: Fitzhenry & White Side Ltd., 195 All States Parkway, Ontario, L3R 4T8.

Australia and New Zealand: Bookwise International Pty Ltd.

174 Cormack Road, Wingfield, SA 5013, Australia.

Asia and other countries: Japan Publications Trading Co., Ltd.,

1-2-1, Sarugaku-cho, Chiyoda-ku, Tokyo 101-0064, Japan.

ISBN-13: 978-4-88996-205-5

ISBN-10: 4-88996-205-0

Printed in Japan



contents



Key to Directions 3

1

SQUARE AND EQUILATERAL TRIANGULAR FLAT UNITS 6~13

Square Flat Units 8

Cube 9

Equilateral Triangular Flat Units 10

Regular Tetrahedron 11

Regular Octahedron and Icosahedron 12

Truncated Regular Tetrahedron: Using equilateral triangular flat units 13

2

COMBINATIONS OF SQUARES AND EQUILATERAL TRIANGLES 14~21

Combinations of Squares and Equilateral Triangles: Cuboctahedron and Rhombicuboctahedron 16

Combinations of Squares and Equilateral Triangles: Variant Cube 17

Equilateral Triangular Elements and Flat Units 18

Equilateral Triangular Elements and Square Flat Units: Cuboctahedron 20

Structures Made of 20 Cuboctahedrons 21

3

A VARIETY OF REGULAR DODECAHEDRONS 22~31

Regular Dodecahedron: Made With 12 units 24

Regular Dodecahedron: Structures Made From 30 Rhomboid Units 26

Icosahedron/dodecahedron: Structures of 60 Rhomboid Units 28

Rhombic icosidodecahedron: Structures With 120 Rhomboid Units 29

Kusudama Dodecahedron 30

4

REGULAR HEXAGONAL FLAT UNITS 32~43

Regular Hexagonal Flat Unit•3 Pockets 34

Truncated Tetrahedron and Octahedron 36

Truncated Icosahedron 37

Regular Hexagonal Flat Unit: Using 3 Pockets (1) 38

Regular Hexagonal Flat Unit: Using 3 Pockets (2) 40

Regular Hexagonal Flat Unit: Using 6 Pockets 42

5

EDGE CUBES 44~51

Edge Cube: Square Windows•Medium 45

Edge Cube: Square Windows•Small 46

Edge Cube: Square Windows•Large 47

Edge Cube: Star-Shaped Windows•Large 48

Edge Cube: Star-Shaped Windows•Small 50

Edge Cube: Star-Shaped Windows•Medium 51

DOUBLE-SIDED CONVEX HEXAGONAL RING SOLID 52~65

Double-sided Convex Hexagonal ring Solid 54

6-unit Structure: Regular Tetrahedron & 12-unit Structure: Octahedron 58

30-unit Structure: Regular Icosahedron 57

36-unit Structure: Truncated Octahedron 58

30-unit Structure: Regular Dodecahedron 59

12-unit Structure: Cube & 24-unit Structure: Cuboctahedron 60

48-unit Structure: Rhombic Cuboctahedron 61

60-unit Structure: Icosahedron/Dodecahedron 62

90-unit Structure: Truncated Icosahedron 63

60-unit Structure: Variant Cube 64

120-unit Structure: Rhombic Icosahedron/Dodecahedron 65

DOUBLE-SIDED CONCAVE HEXAGONAL RING SOLIDS 66~77

Double-sided Concave Hexagonal ring Solid 68

36-unit Structure: Truncated Hexahedron 70

30-unit Structure: Regular Dodecahedron 71

36-unit Structure: Truncated Octahedron 72

72-unit Structure: Rhombic Truncated Octahedron 73

60-unit Structure: Icosahedron/Dodecahedron 74

90-unit Structure: Truncated Icosahedron 75

120-unit Structure: Rhombic Icosahedron/Dodecahedron 76

Double-sided Hexagonal Rings: From Different Sizes of Paper 77

VARIOUS METHODS OF ASSEMBLING DOUBLE-SIDED HEXAGONAL RINGS 78~89

Various Methods of Assembling Double-sided Convex Hexagonal Ring: 36-unit Structure 80

Various Methods of Assembling Double-sided Convex Hexagonal Ring: 44-unit Structure 81

Various Methods of Assembling Double-sided Convex Hexagonal Ring: 40-unit & 68-unit Structures 82

Various Methods of Assembling Double-sided Convex Hexagonal Ring: 24-unit & 28-unit Structures 83

Various Methods of Assembling Double-sided Convex Hexagonal Ring: 75-unit Structures 84

Various Methods of Assembling Double-sided Convex Hexagonal Ring: 90-unit Structures 85

Mixed Structures of Double-sided Convex & Concave Hexagonal Rings Around Cores of Truncated Hexahedron: 69-unit Structure 86

Mixed Structures of Double-sided Convex & Concave Hexagonal Rings Around Cores of Truncated Hexahedron: 48-unit Structure 87

Mixed Structures of Double-sided Convex & Concave Hexagonal Rings Around Cores of Truncated Hexahedron: 68-unit Structure 88

Mixed Structures of Double-sided Convex & Concave Hexagonal Rings Around Cores of Truncated Hexahedron: 60-unit Structure 89

DIAGONALLY FOLDED TRIANGULAR UNIT SOLIDS 90~98

Diagonally Folded Triangular Unit 92

6-unit Structure: Regular Tetrahedron Star & 12-unit Structure: Regular Octahedron Star 94

30-unit Structure: Regular Icosahedron Star 95

24-unit Structure: Cuboctahedron Star 96

48-unit Structure: Rhombic Cuboctahedron Star 97

60-unit Structure: Variant Cube Star 98

List of Polyhedrons 99



This One

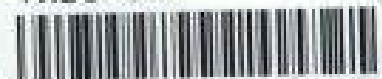

Material: WL85-A00-2W4C autorais



SQUARE AND EQUILATERAL TRIANGULAR FLAT UNITS

Each side has a pocket into which a joint is inserted to make three-dimensional figures.

Regular Octahedron /p.12



Truncated Regular Tetrahedron /p.13

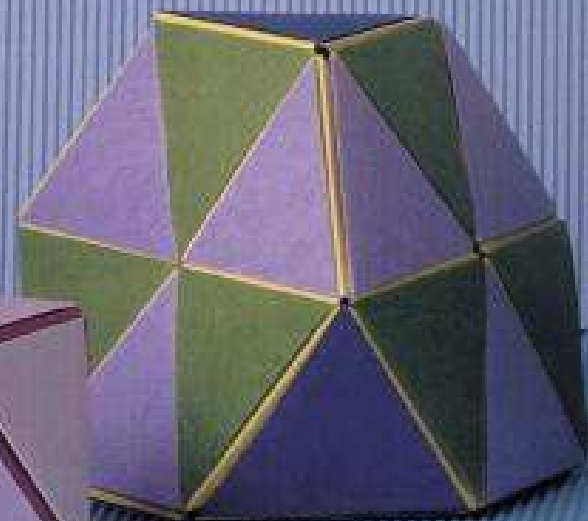

Regular Tetrahedron /p.11

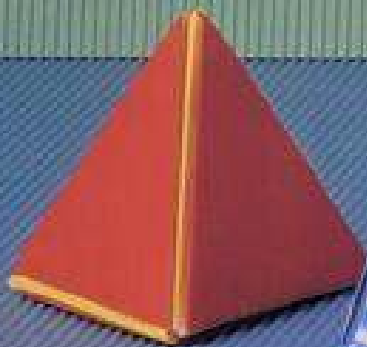

Regular Icosahedron /p.12



Cubes /p.9



SQUARE FLAT UNITS

level ★

15cm × 15cm

Assemble by inserting joints into four pockets.

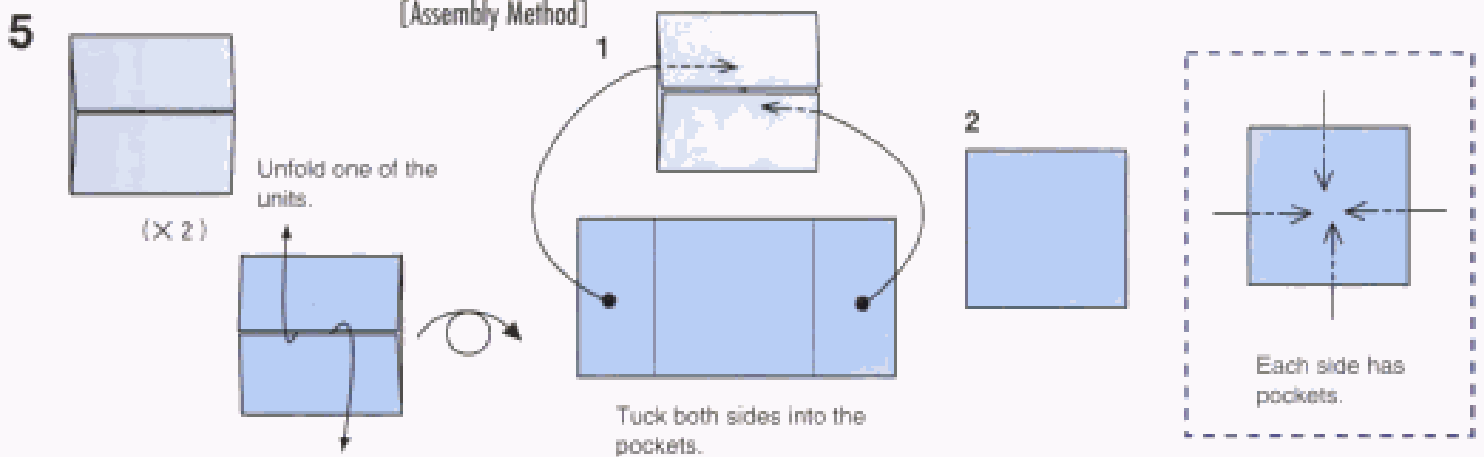
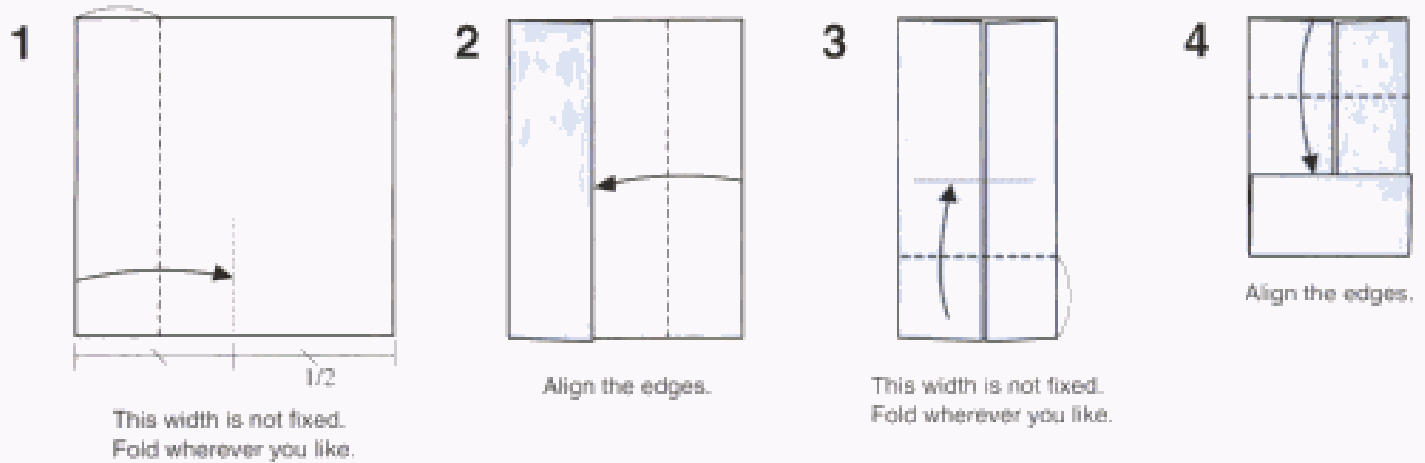

Joints ● Use Method A for joints, but when the paper is thick or difficult to assemble, use B.

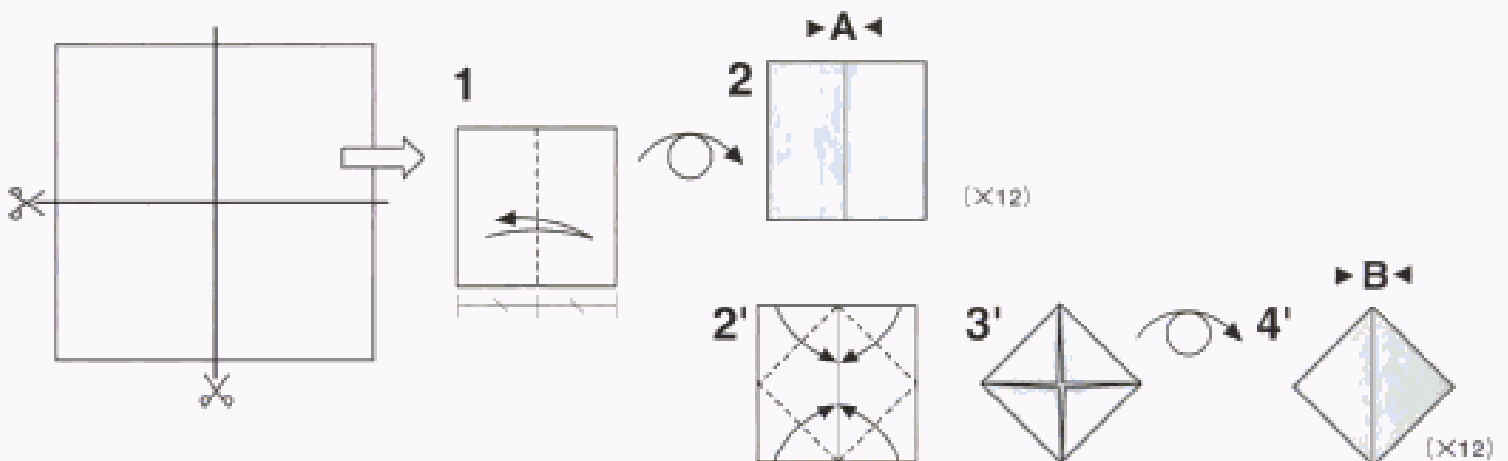

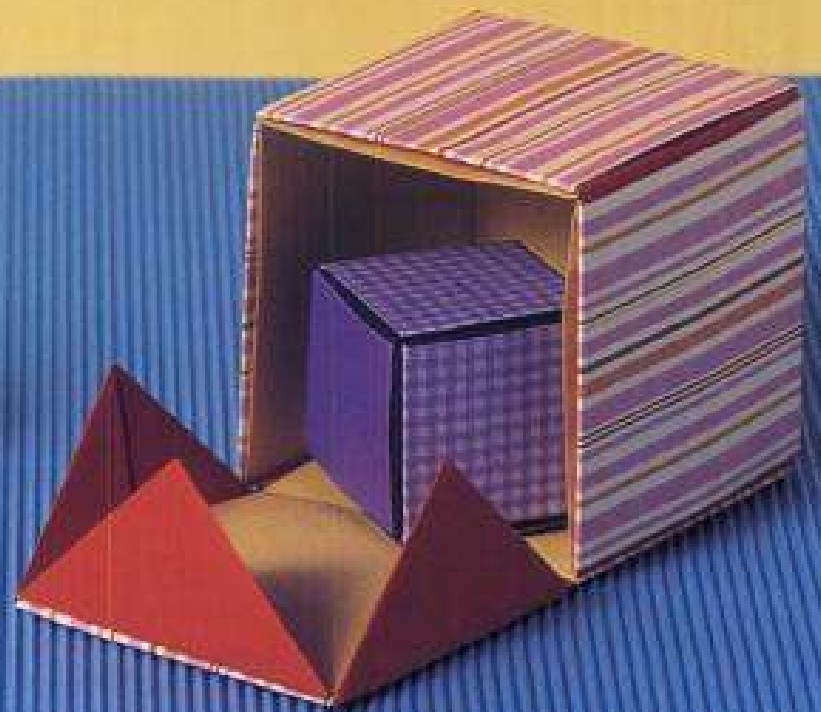

CUBE level ★

15cm × 15cm

Consider the various schematic diagrams.

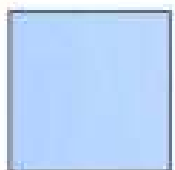

(X6)



(X12)

The cubes in the photo were assembled using joint B.

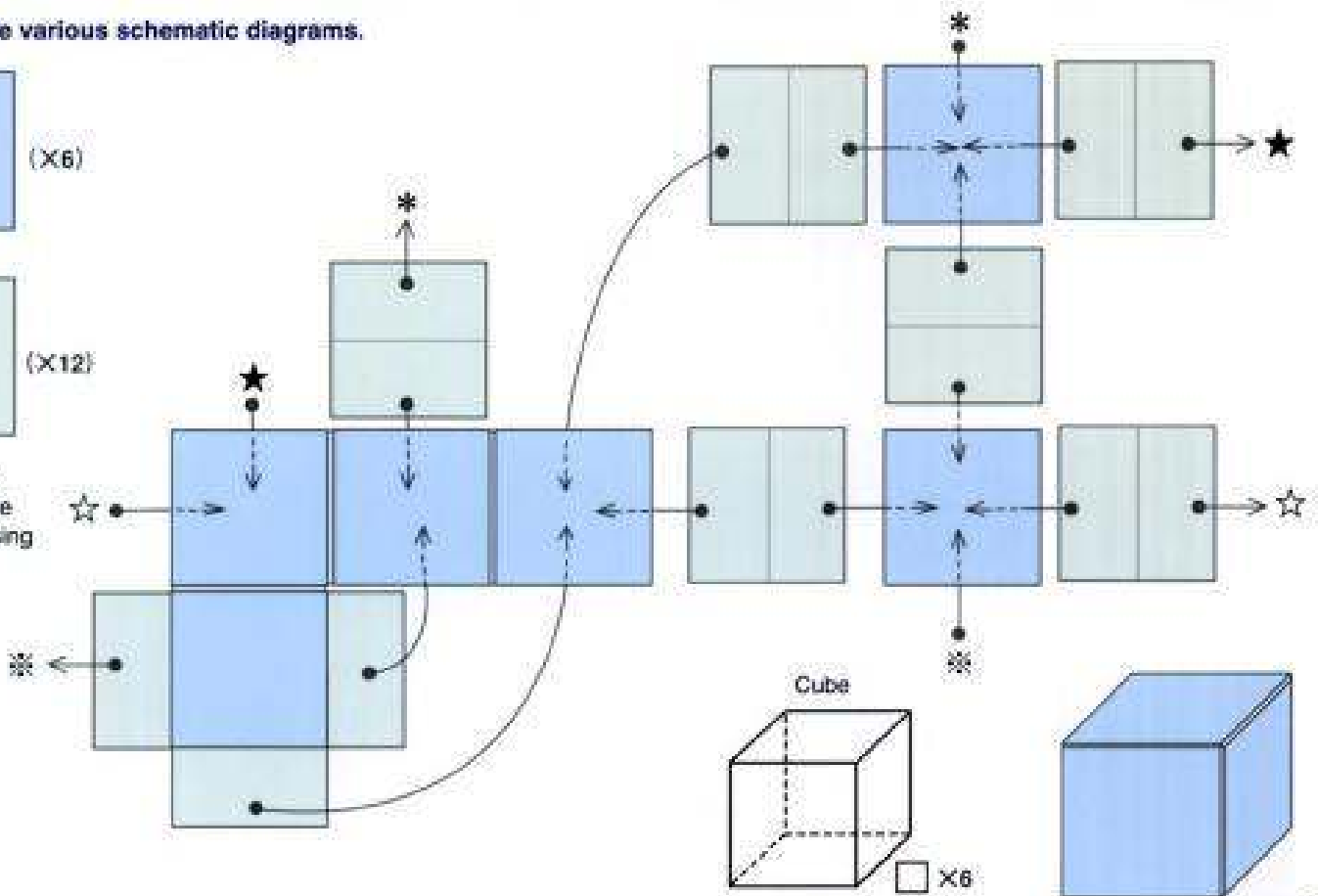

EQUILATERAL TRIANGULAR FLAT UNITS

level ★★

15cm × 15cm

The unit has pockets on three sides, and it is assembled by inserting joints into them.

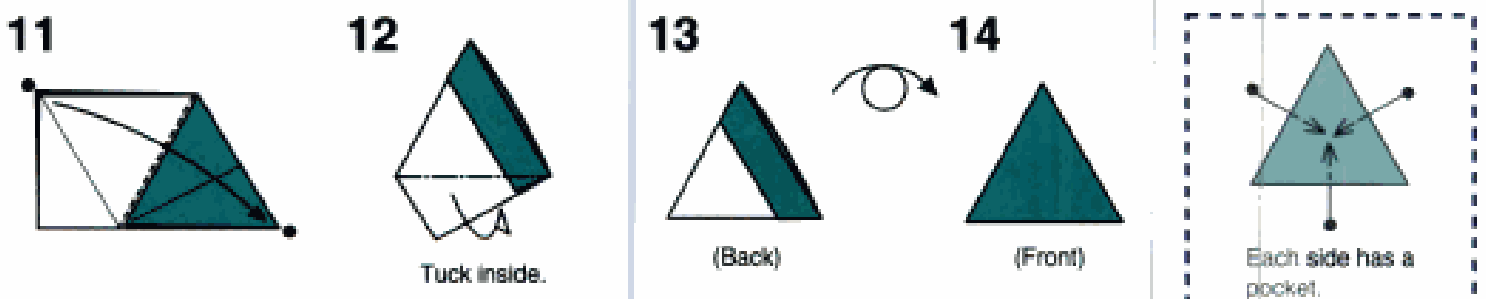
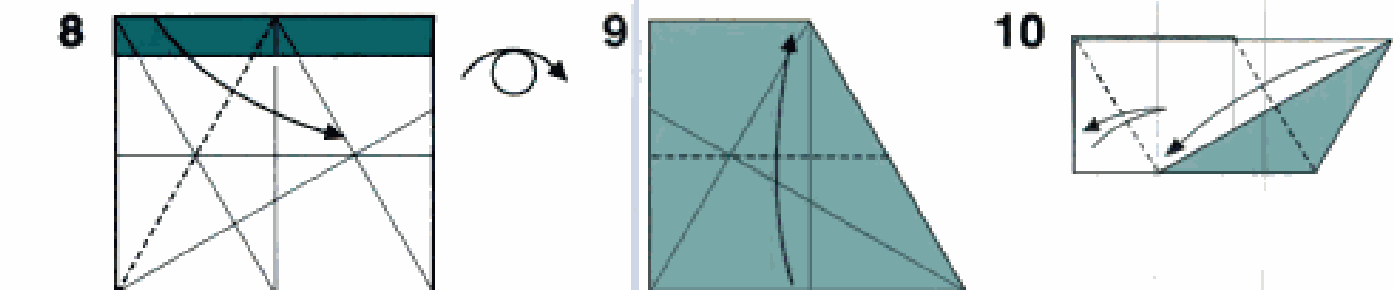
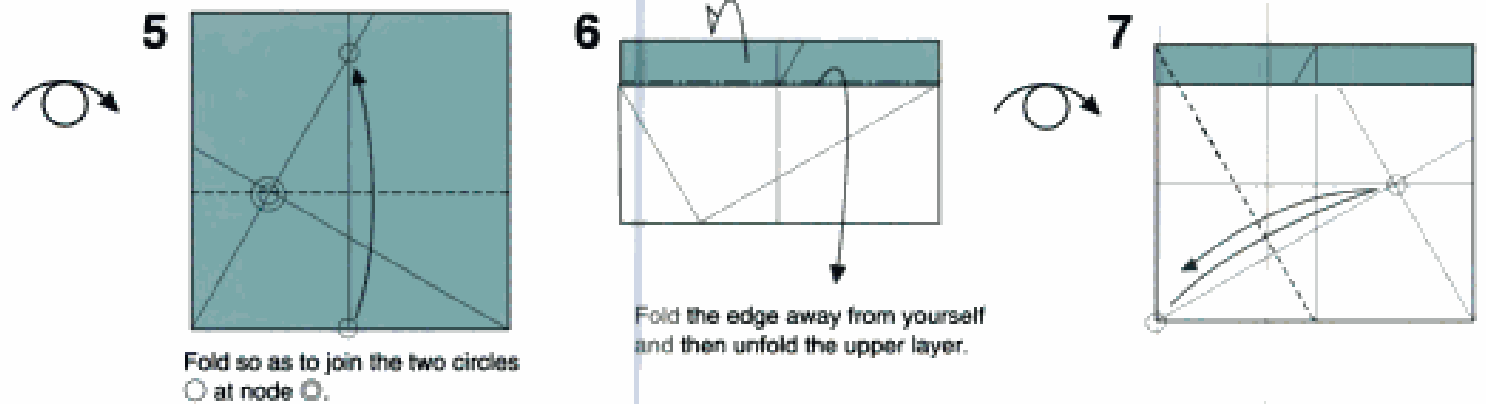
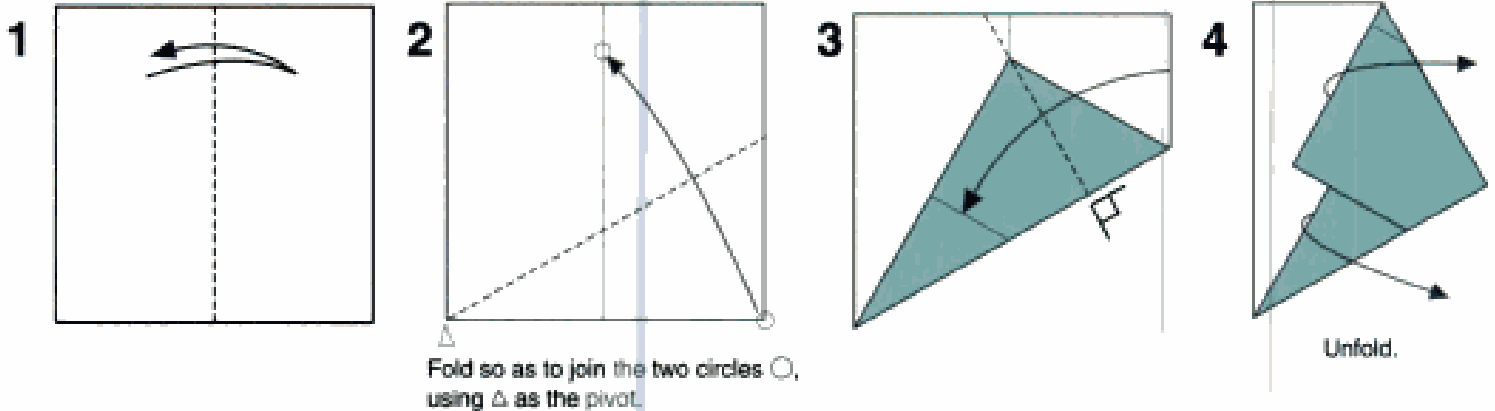

Joint B

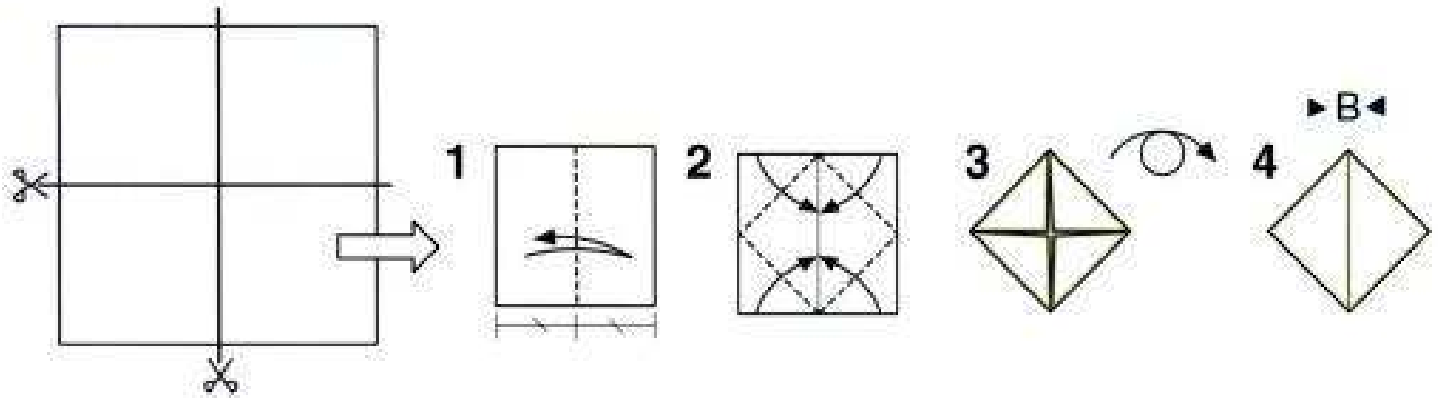

REGULAR TETRAHEDRON

level ★

15cm × 15cm

Equilateral
Triangular Flat Unit

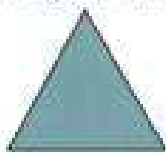

(X4)

Joint B

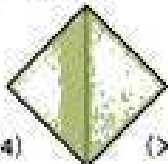

(X6)

[Assembly Method]

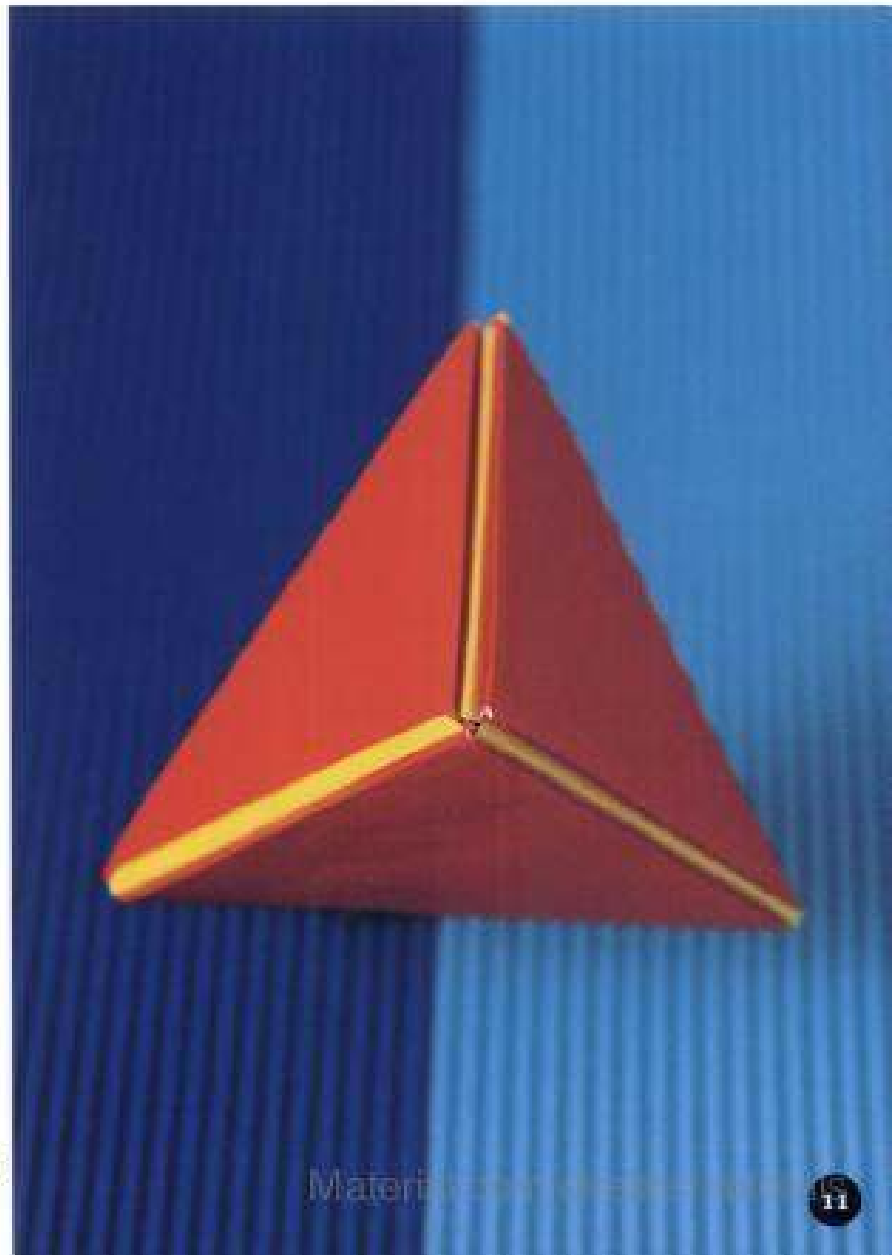
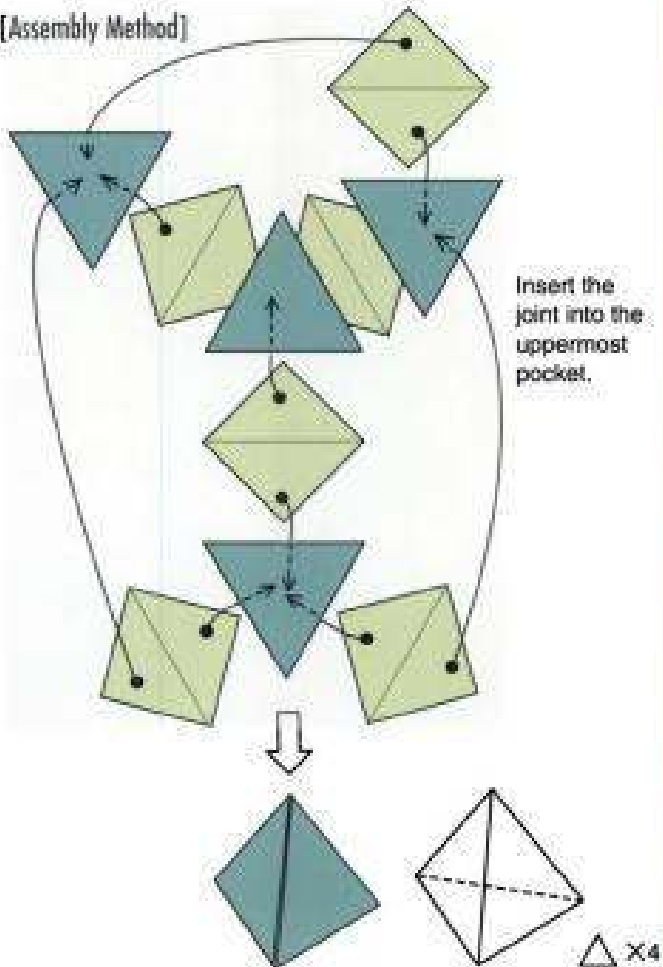

REGULAR OCTAHEDRON AND ICOSAHEDRON

level ★

15cm × 15cm

Equilateral Triangular
Flat Unit (p.10)



Joint B (p.11)



Regular Octahedron

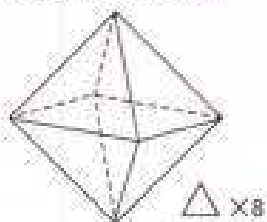

Equilateral Triangular
Flat Unit (p.10)



Joint B (p.11)



Regular Icosahedron



TRUNCATED REGULAR TETRAHEDRON Using equilateral triangular flat units.

level ★★

12cm × 12cm

You can make a regular hexagon by joining 6 equilateral triangular flat units. It is possible to combine this hexagon with equilateral triangular units.

(Assembly Method)

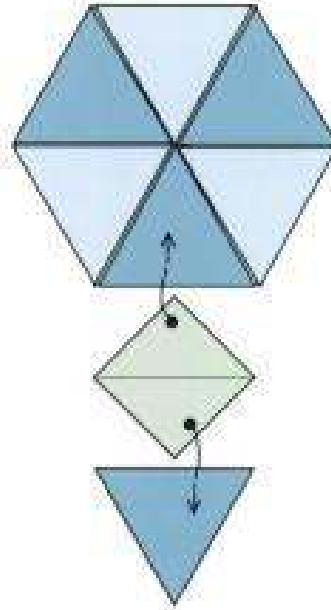
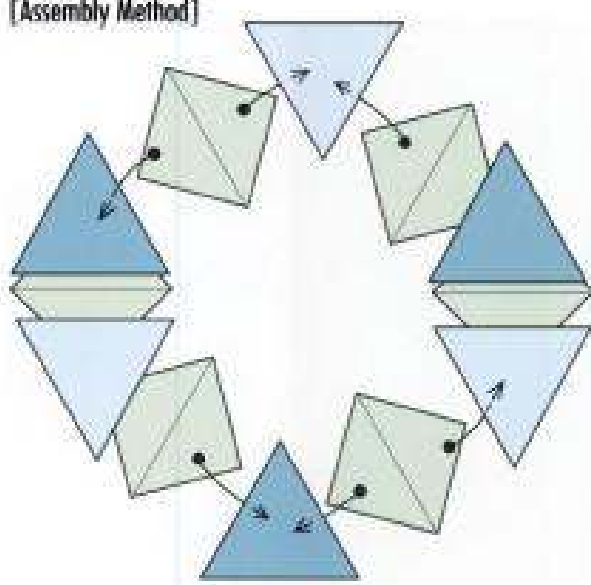

Equilateral Triangular Flat Unit (p.10)

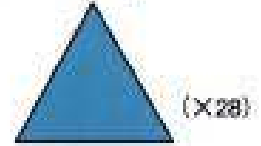

Joint B (p.11)

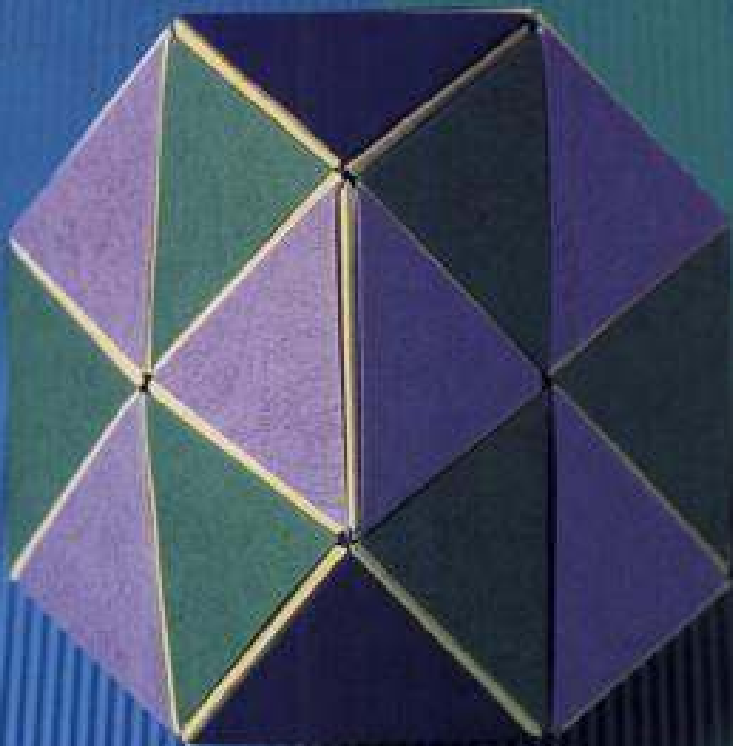
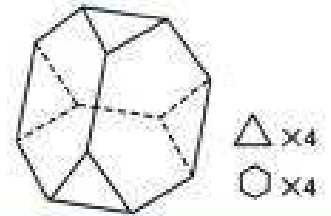
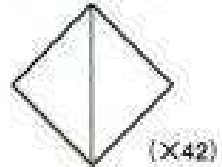

2

COMBINATIONS OF SQUARES AND EQUILATERAL TRIANGLES

Squares and equilateral triangles folded from the same size of paper have sides of the same length, and it is possible to connect them. By adding even more components, you can make large, splendid polyhedrons.

ELEMENTS AND FLAT UNITS OF EQUILATERAL TRIANGLE /p.18

REGULAR OCTAHEDRON



VARIANT CUBE /p.17

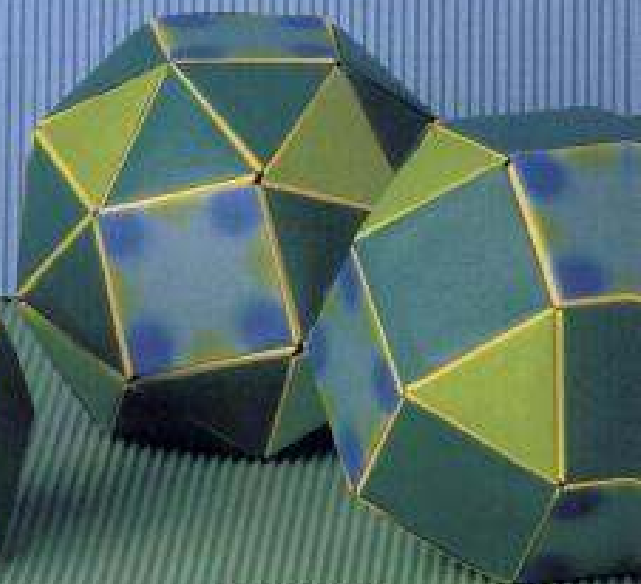

CUBOCTAHEDRON /p.16

RHOMBIC CUBOCTAHEDRON /p.16

A STRUCTURE MADE OF 20 CUBOCTAHEDRONS /p.21

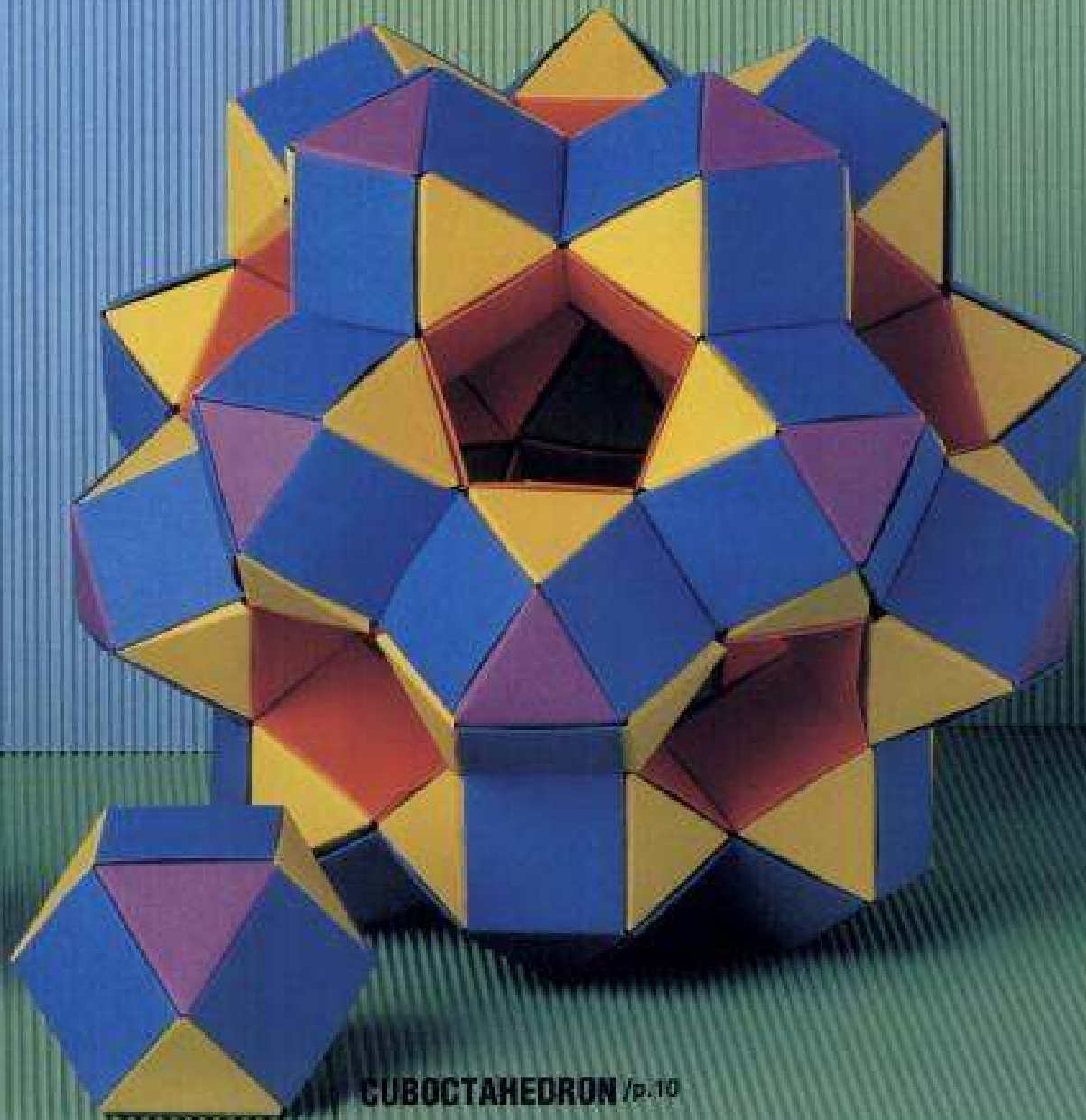

CUBOCTAHEDRON /p.10

CUBOCTAHEDRON AND RHOMBIC CUBOCTAHEDRON

level ★★

7.5cm × 7.5cm

Square and equilateral triangular flat units folded from the same size of paper have sides of the same length, and it is possible to join them to make various solids.

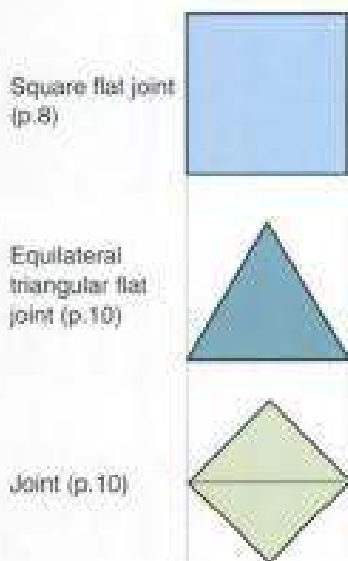

[Assembly Method]



Cuboctahedron

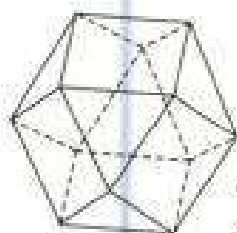

△ × 8 □ × 6

Joint × 24

Rhombic cuboctahedron

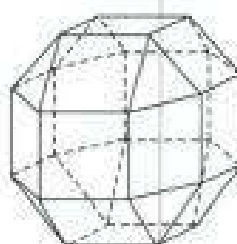

△ × 8 □ × 18

Joint × 48

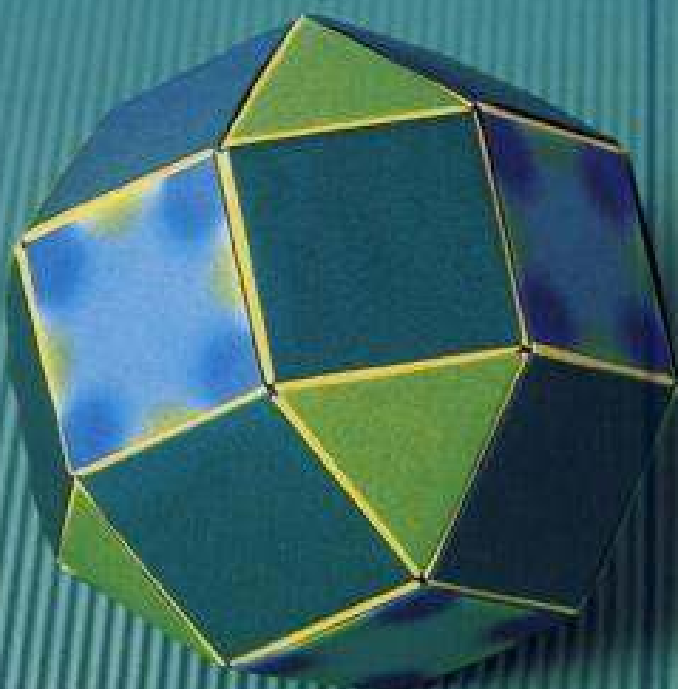

VARIANT CUBE level ★★★

7.5cm × 7.5cm

Variant cube

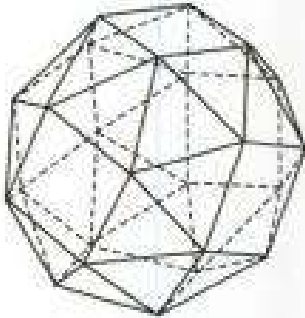

△ × 32 □ × 6

Square flat joint (p.8)

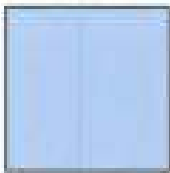

(×6)

Equilateral triangular flat joint (p.10)

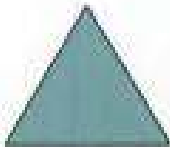

(×32)

Joint B (p.11)

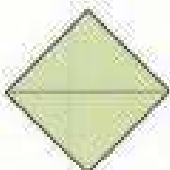

(×60)



EQUILATERAL TRIANGULAR ELEMENTS AND FLAT UNITS

EQUILATERAL TRIANGULAR ELEMENTS

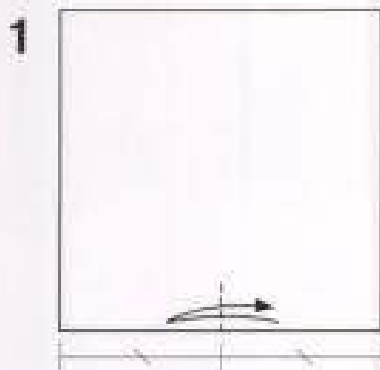

Make a short crease on the lower side.

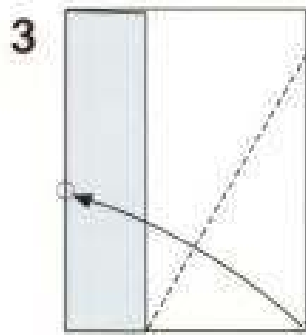
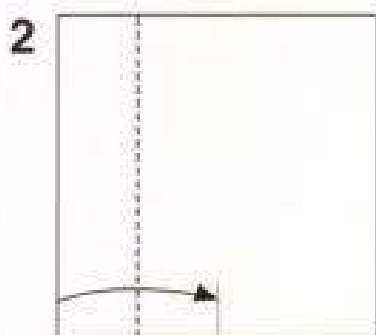

Fold on the crease Δ to join the spots marked by the two circles.

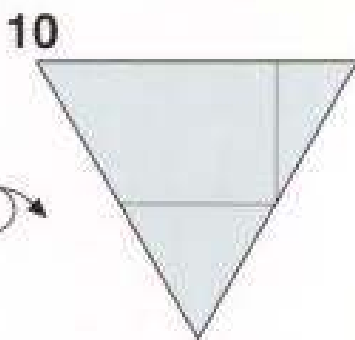
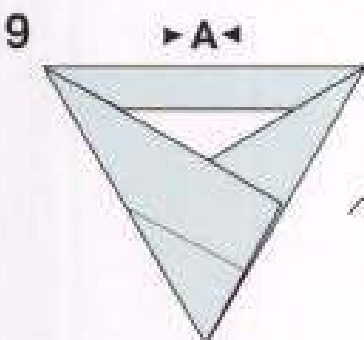
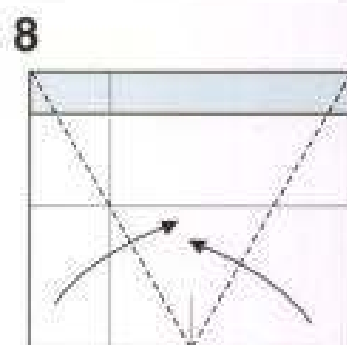
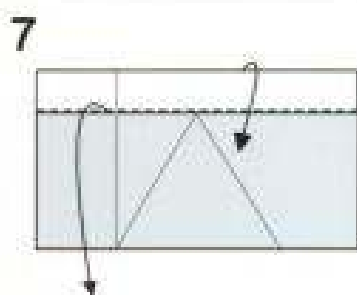
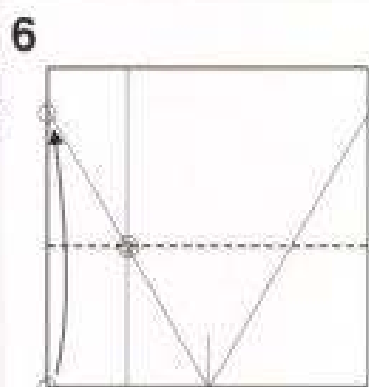
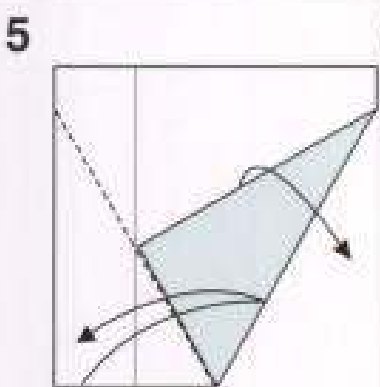
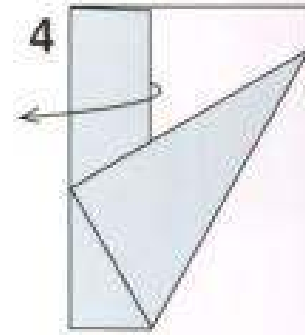

[Assembly Method]

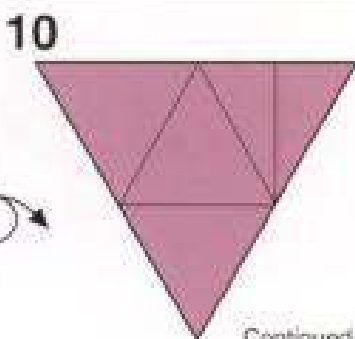
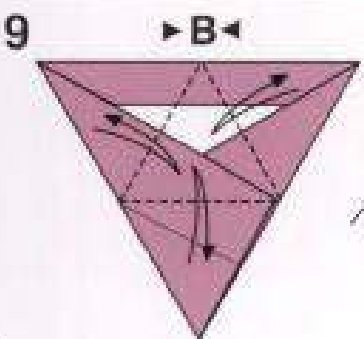
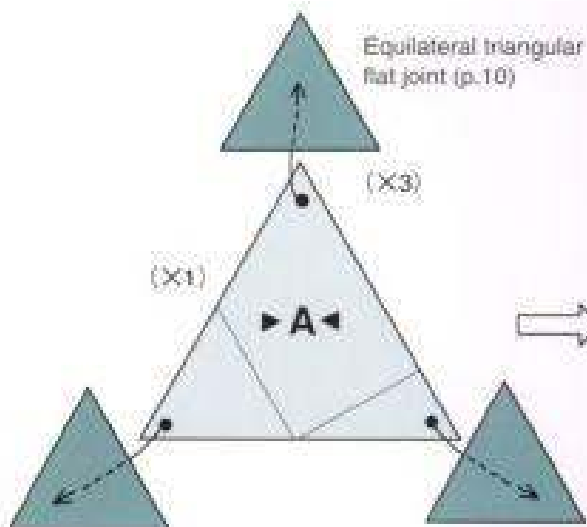

Continued on p.20 and p.21.

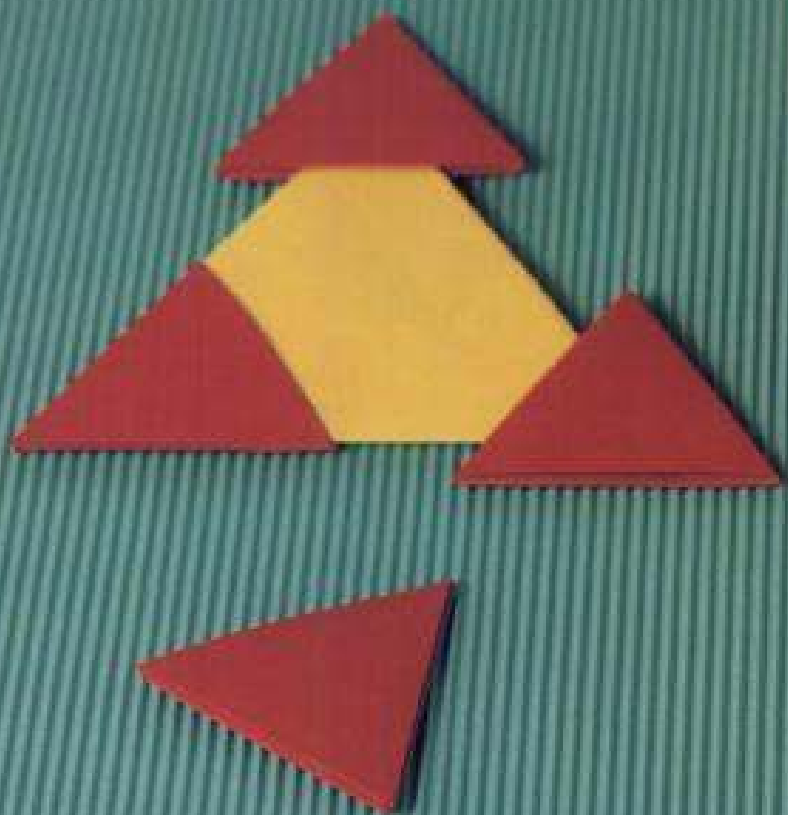

REGULAR OCTAHEDRON

A quadruple equilateral triangle is made by combining 1 equilateral triangular element and 3 equilateral triangular flat units.

(Quadruple equilateral triangle) Use 7.5 cm x 7.5 cm paper.
Treat this as 1 triangle.

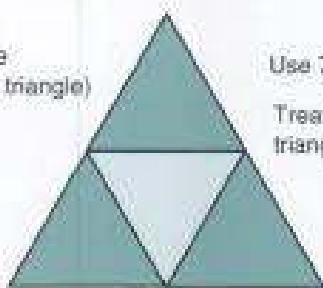

Quadruple equilateral triangle

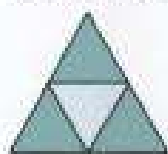

Joint B



Regular tetrahedron (X4)
Regular octahedron (X8)
Regular icosahedron (X20)

(X12)
(X24)
(X60)

[Assembly Method]

Joint B (p.11)

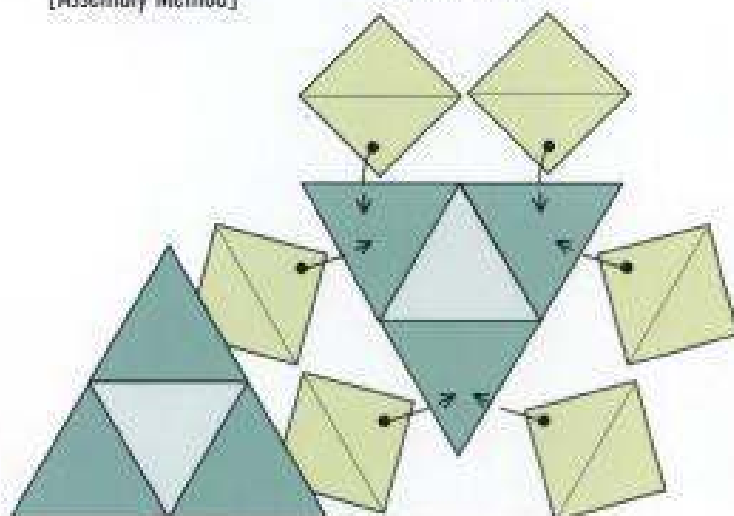



Square flat unit (p.8)



(x8)

Equilateral Triangular
Element B (p.18)

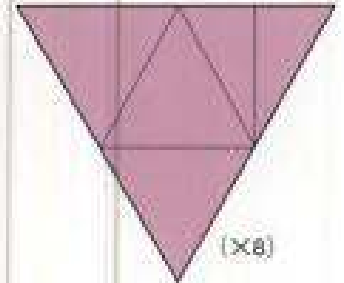

(x8)

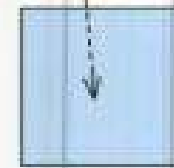
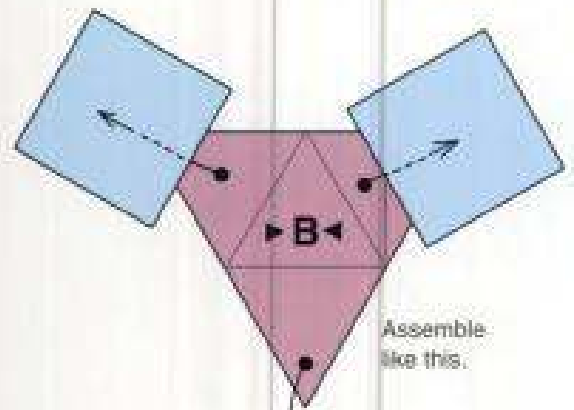

Cuboctahedron



△ x8 □ x6

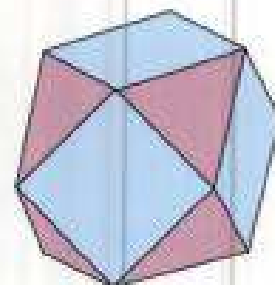

STRUCTURES MADE OF 20 CUBOCTAHEDRONS

level ★★★

8cm × 8cm

Square flat unit (p.8)

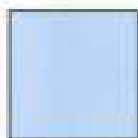

(×120 : 240 sheets of paper)

5 inside rings of square flat units (orange) $5 \times 12 = 60$

2 outside square flat units (blue) $2 \times 30 = 60$

Joint B (p.11)

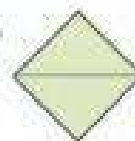

(×90)

5 inside square flat units $5 \times 12 = 60$

2 outside square flat units 30

Equilateral triangular element B (p.18)

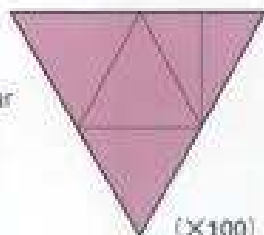

(×100)

Inside triangles (yellowish green) 20

Outside star-shaped triangles (yellow) $5 \times 12 = 60$

Exterior triangles (purple) 20

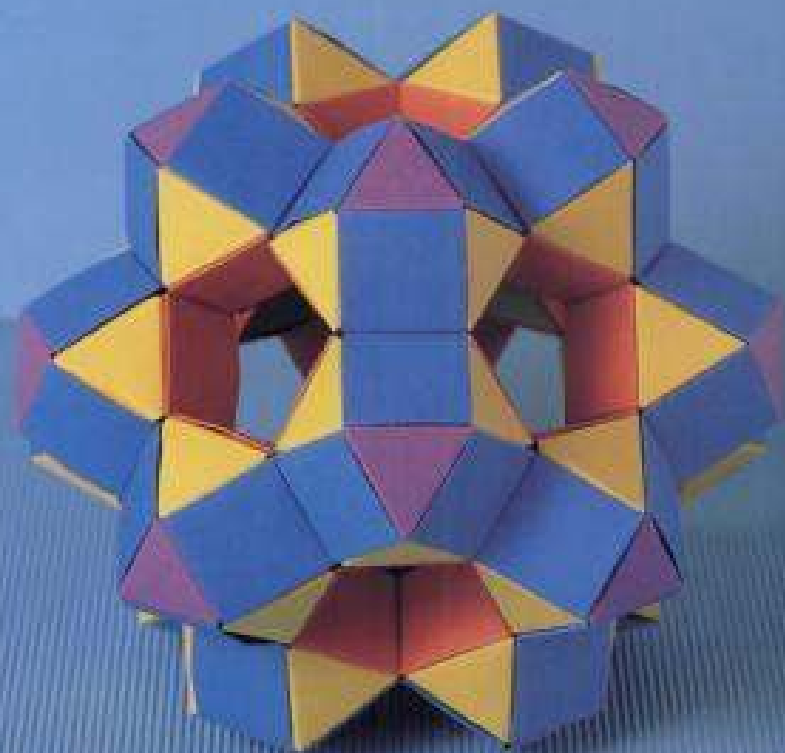
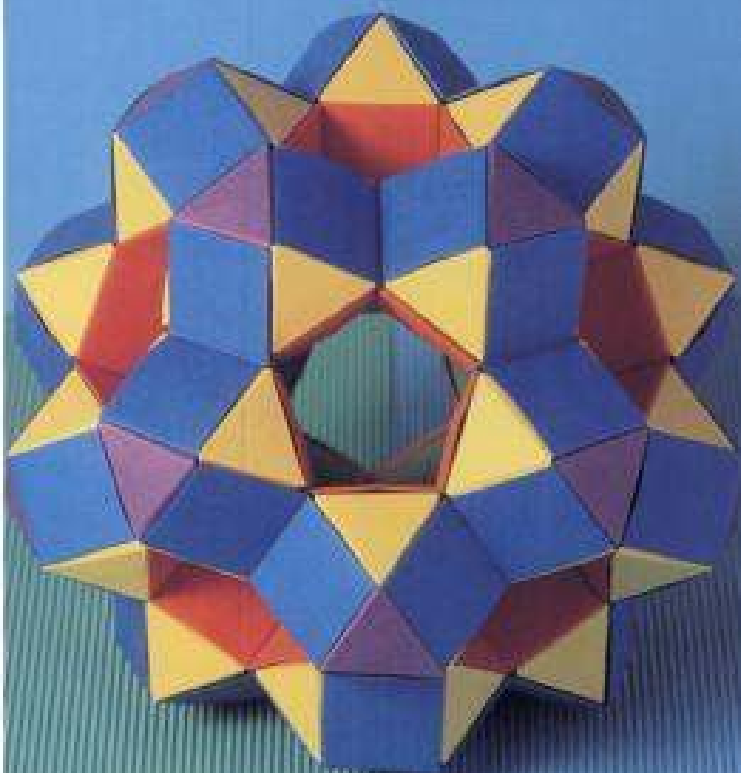

3

A VARIETY OF REGULAR DODECAHEDRONS

Surface patterns depend on the number of dodecahedrons used. It is possible to assemble them with 60 or 120 rhomboid units.

VARIANT KUSUDAMA DODECAHEDRON /p.30



**RHOMBIC CUBOCTAHEDRON,
DODECAHEDRON AND:
MADE WITH 120 RHOMBOID UNITS** /p.29

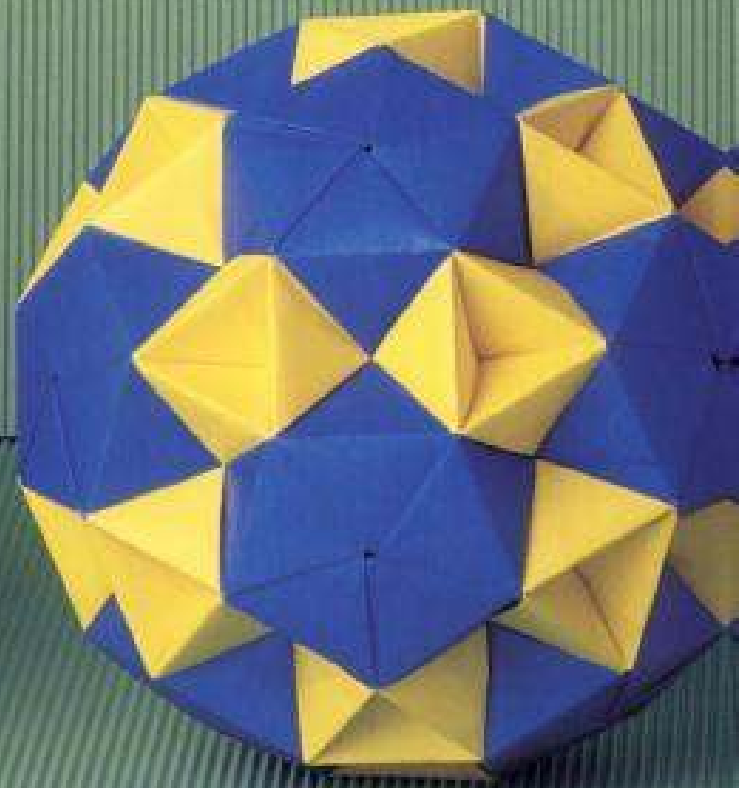

KUSUDAMA DODECAHEDRON /p.30

**REGULAR ICOSAHEDRON:
MADE WITH 30 RHOMBOID UNITS /p.26**

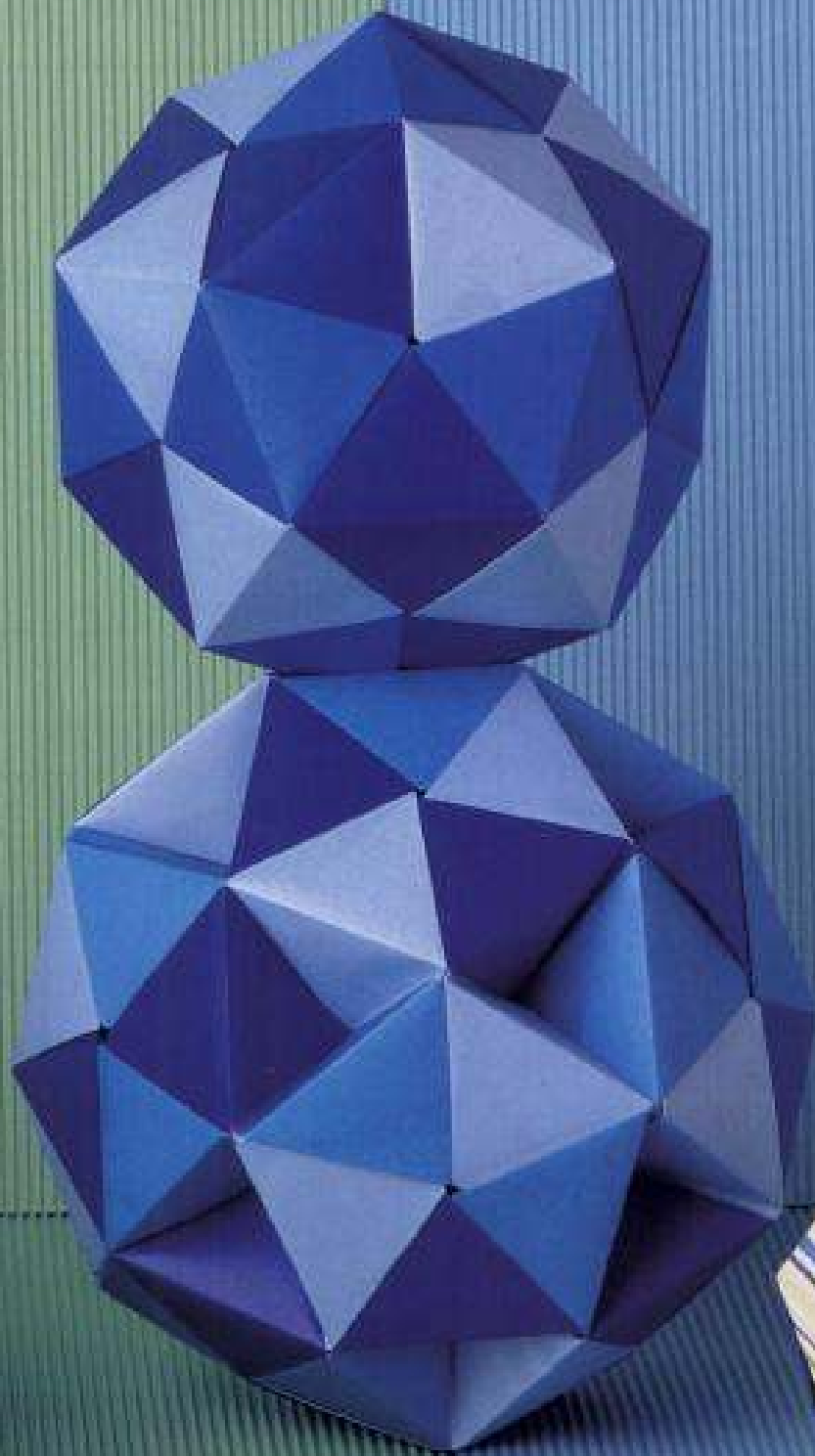

**12 REGULAR
DODECAHEDRONS /p.24**



**ICOSAHEDRON, DODECAHEDRON:
MADE WITH 60 RHOMBOID UNITS /p.28**



1 Make short creases on the upper and lower sides.



2 Fold along the line marked by the two circles to make a crease.

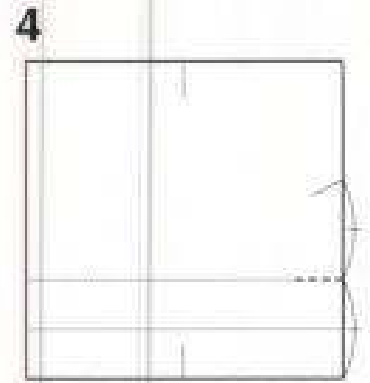
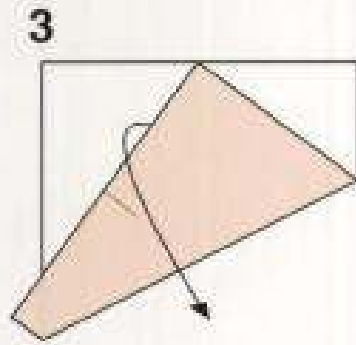

4 Make a short crease on the right side.

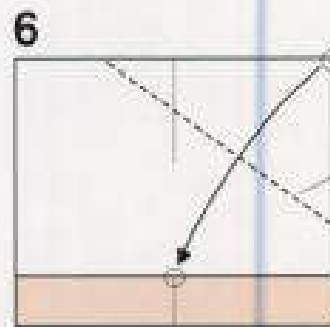
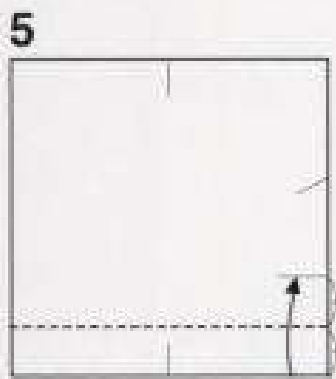

6 Fold so as to join the two circles ○.

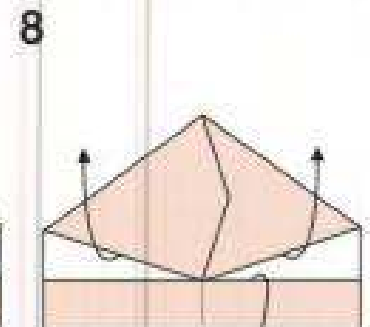
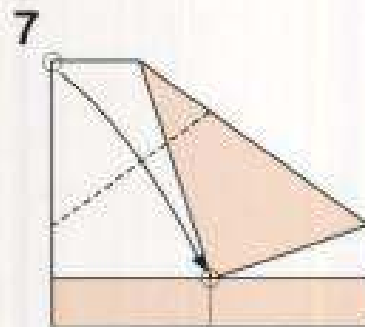

8 Unfold.

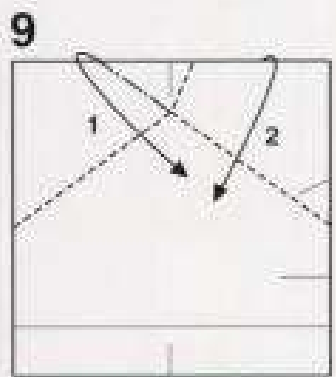

9 Fold in numerical order.

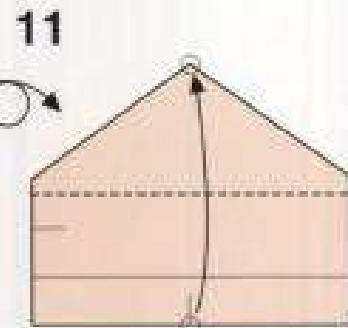
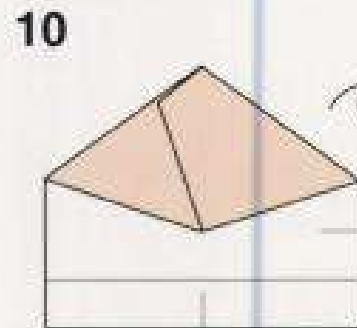

11 Fold so as to join the two circles ○.

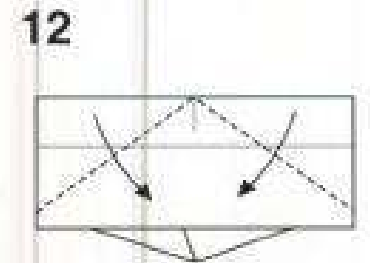

12 Fold the upper corners down.

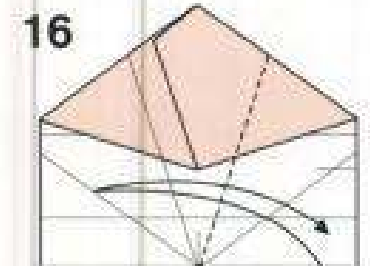
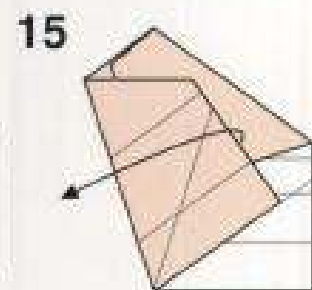
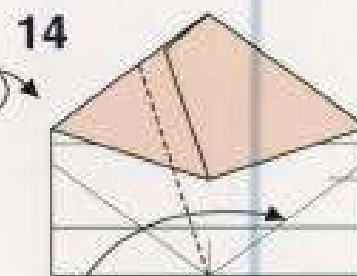
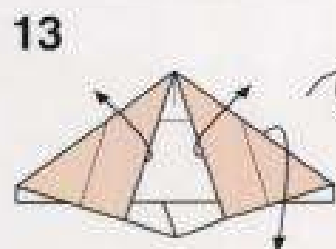

16 Fold the other side in the same way.

17

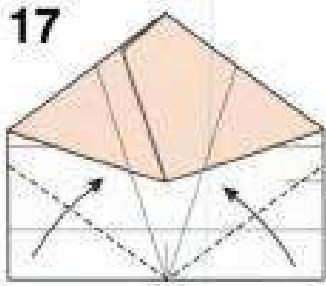

18

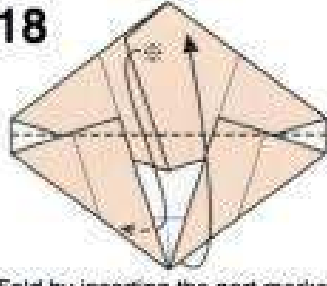

Fold by inserting the part marked with a star ☆ into the pocket.

19

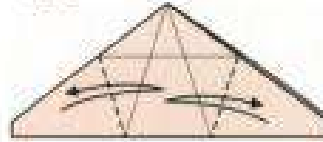

Make creases by aligning edges with the line.

20

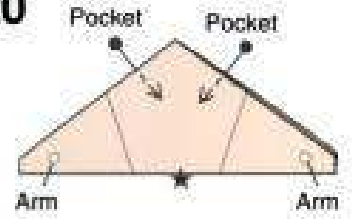

★ is closed.

(X12)

[Assembly Method] Connect by joining the spots marked with stars ★.

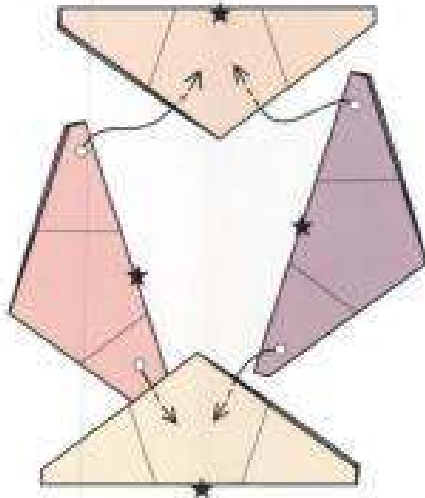

Assemble 12 units like this.

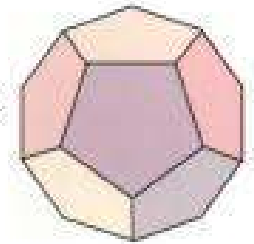
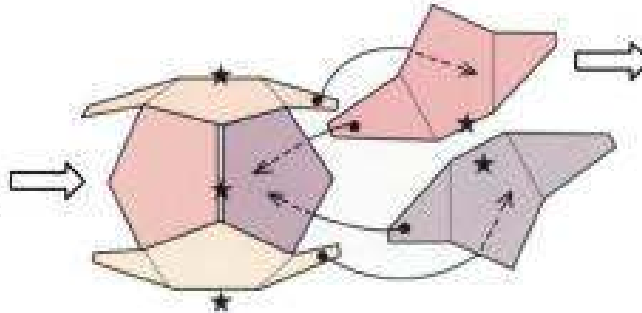

Make a rectangular pattern paper.

Methods 1-3 were worked out by Kazuo Haga.

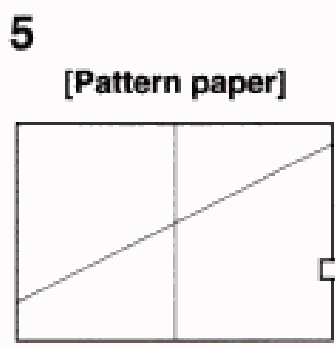
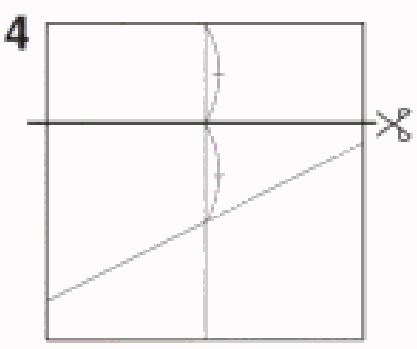
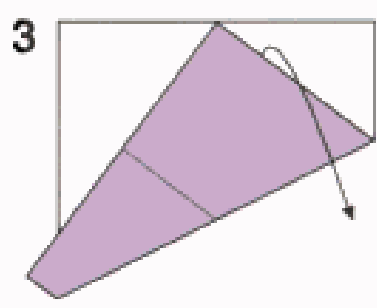
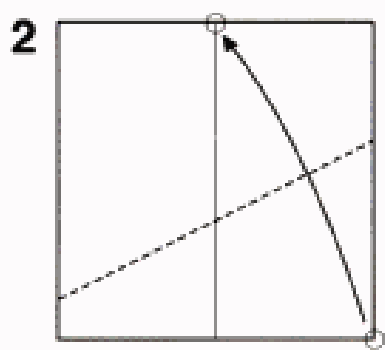
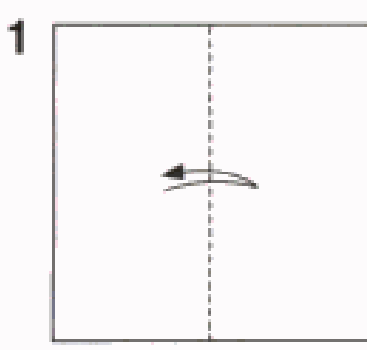

Put sheets of paper on top.

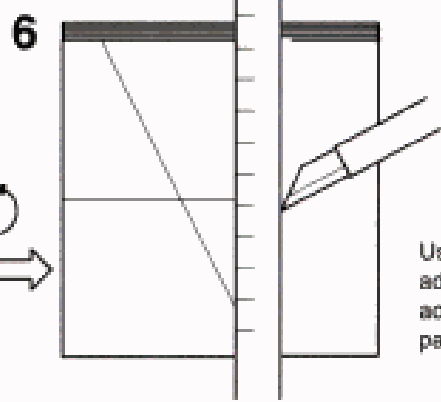

Use a cutter to cut additional sheets according to the pattern.

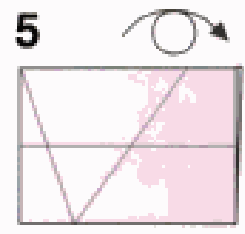
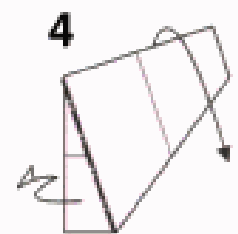
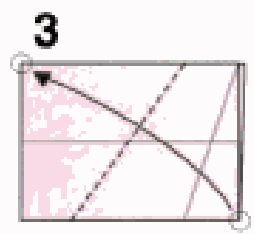
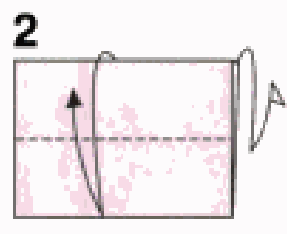
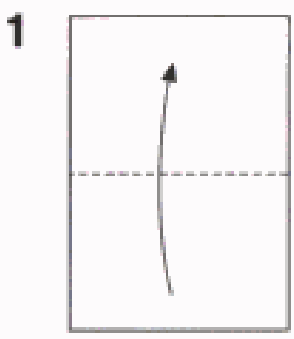

Make creases and unfold.

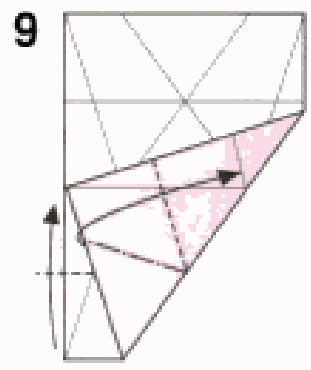
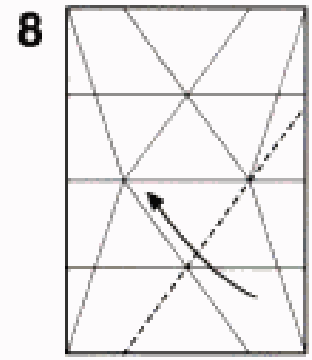
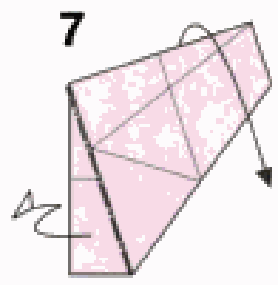
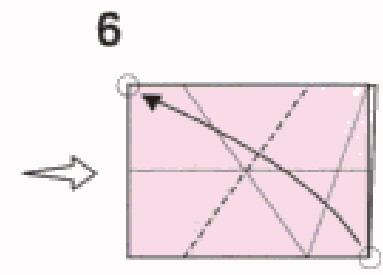

10

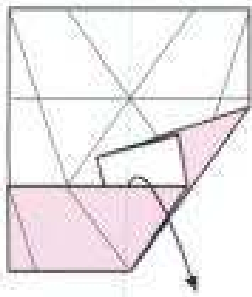

Unfold.

11

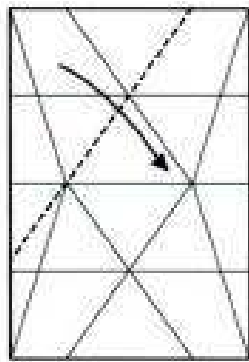

12

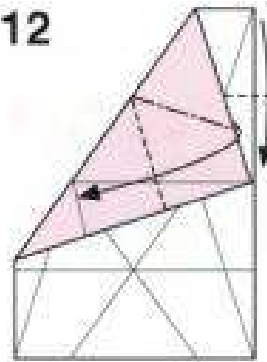

13

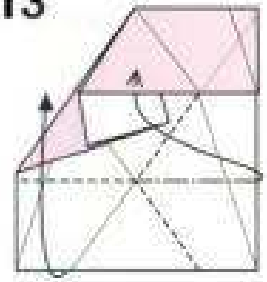

14

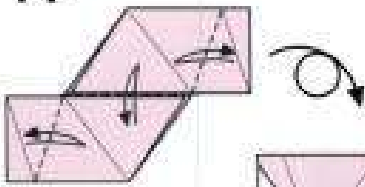

Make creases by folding both edges along the edges as shown below.

15

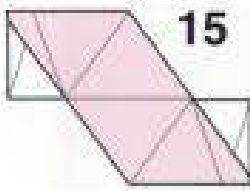

(x30)

[Assembly Method]

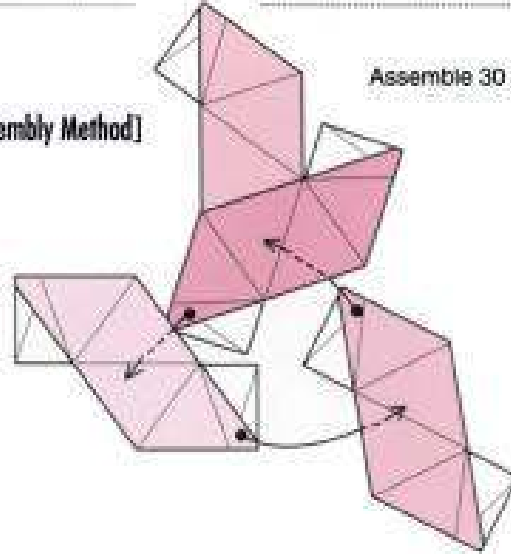

Assemble 30 units like this.

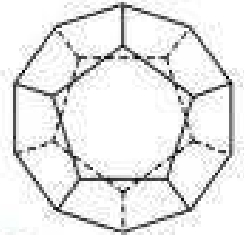

x12

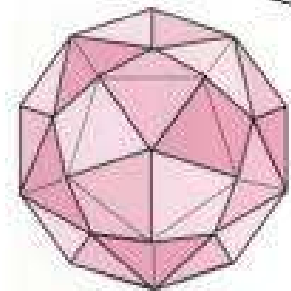

Rhomboid unit (From step 14 on p.26)

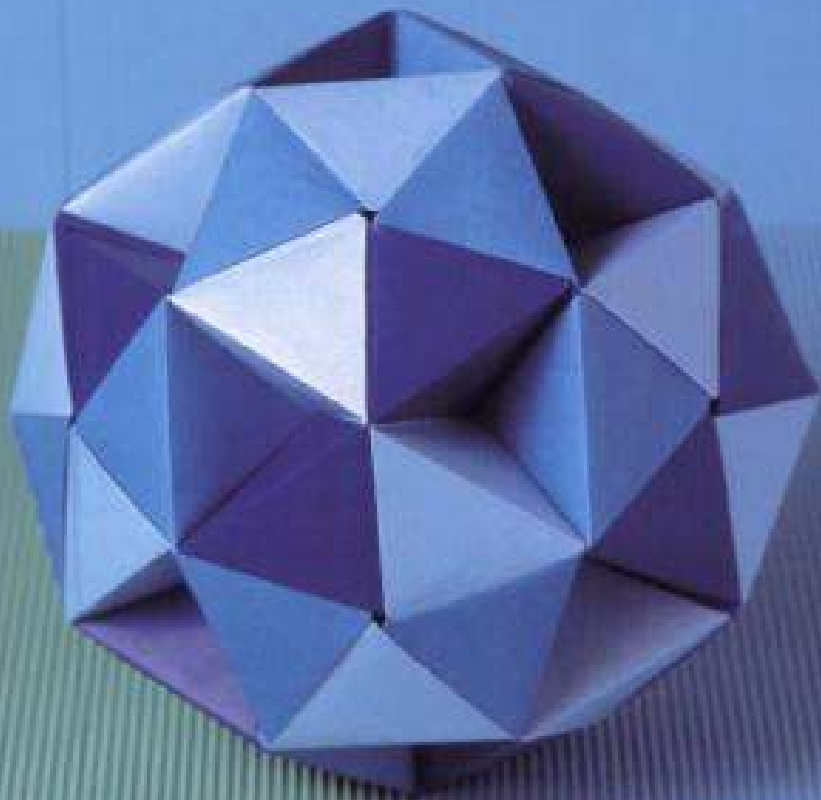
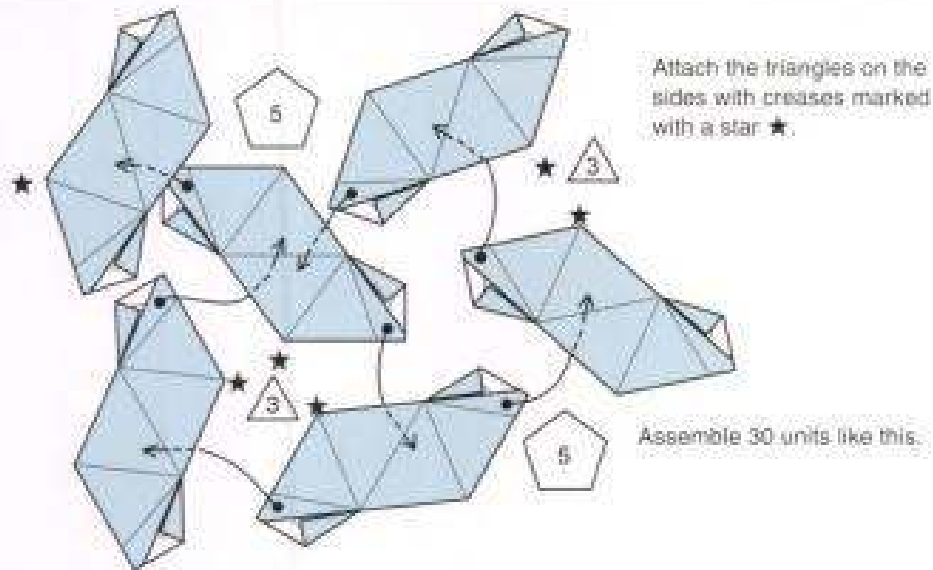
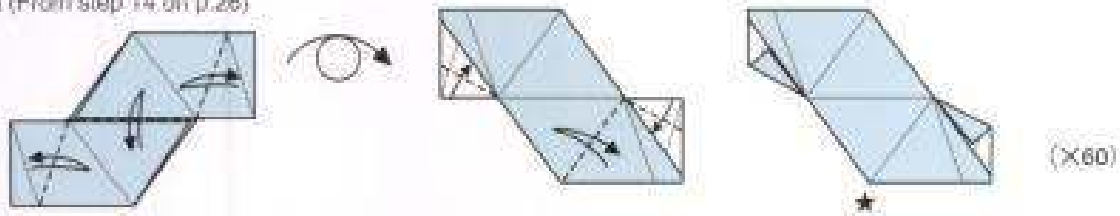

Rhombic Icosa-dodecahedron STRUCTURE WITH 120 RHOMBOID UNITS

level ★★★

12cm × 12cm

(A) has 1 crease and (B) has 2 creases. Assemble each of 60 units on the sides with the creases marked ★.

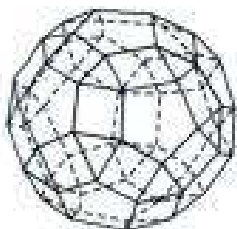
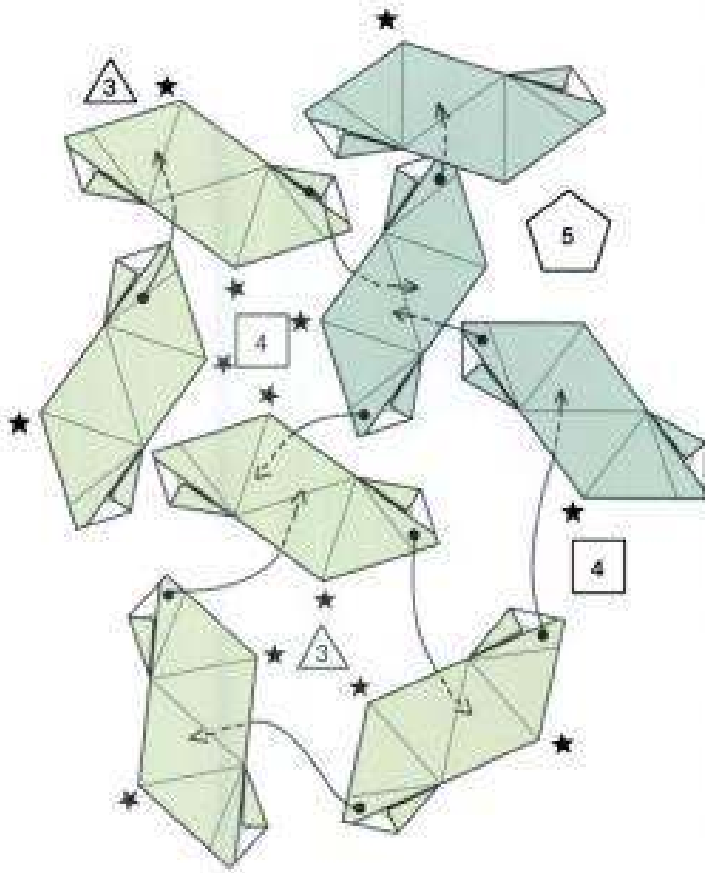
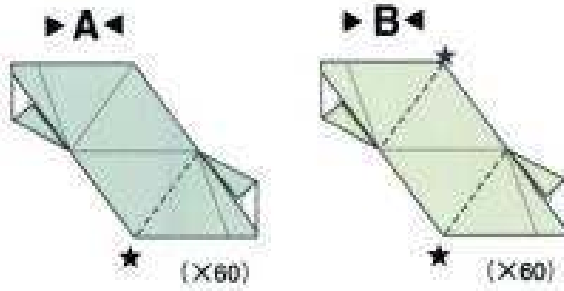

△×20 □×30 ○×12

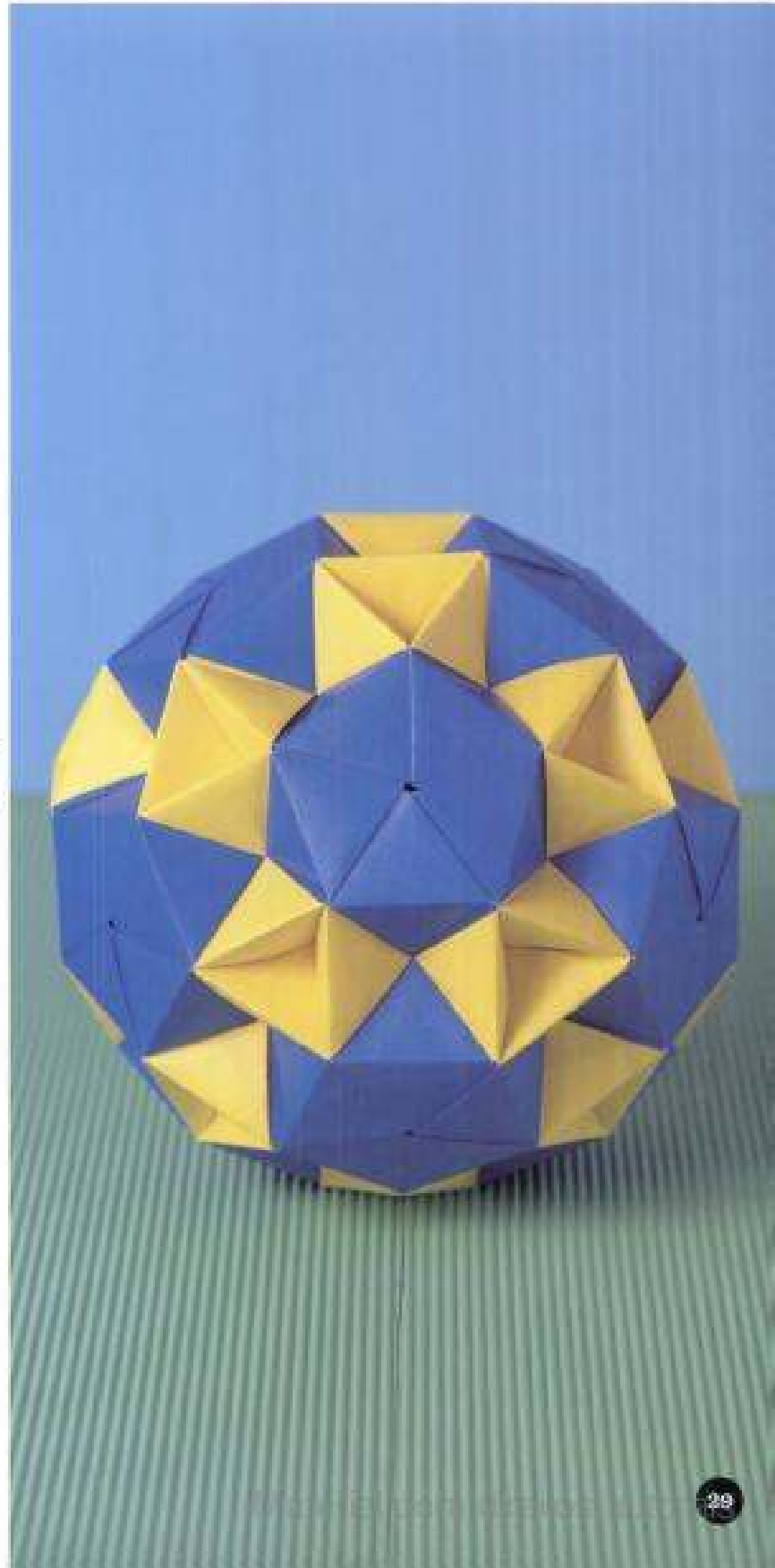

KUSUDAMA DODECAHEDRON

level ★★

15cm × 15cm

Cut a square into three equal parts and make a rectangle with sides in a 1:3 ratio.

1

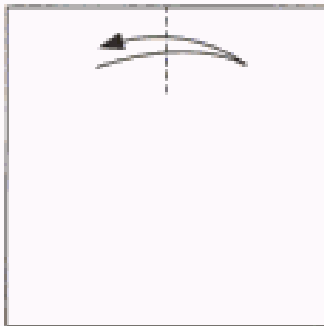

Make a short crease on the upper side.

2

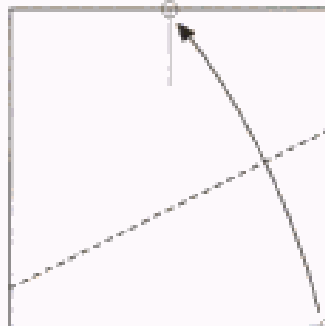

Fold so as to join the circles ○.

3

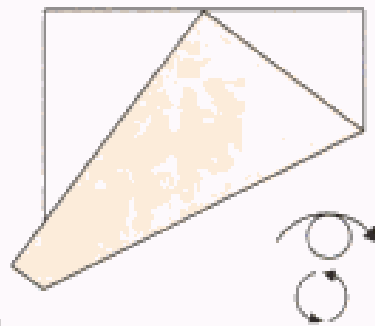

4

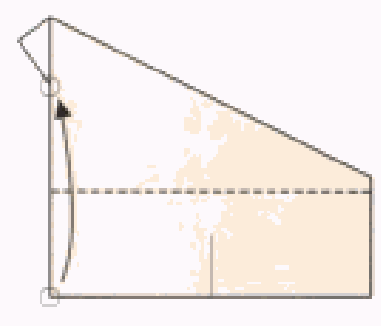

Fold so as to join the circles ○.

5

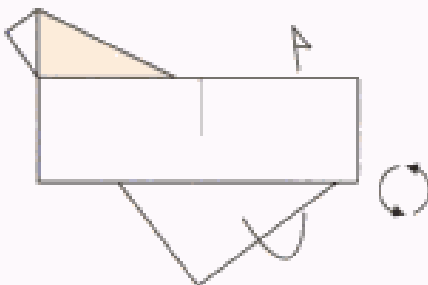

Unfold the back.

6

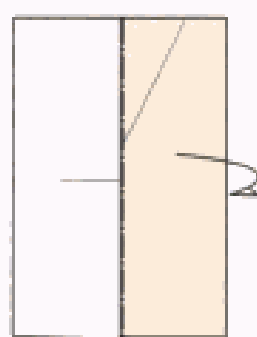

7



[Use your own judgment about where to fold the paper]



You may fold the paper into three layers, estimating the right place to fold it, and then flatten it.

8

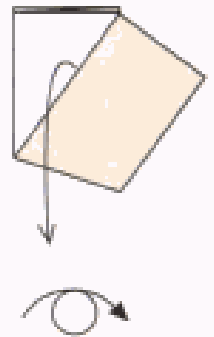

9

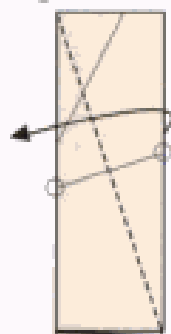

Fold only the upper layer.

10

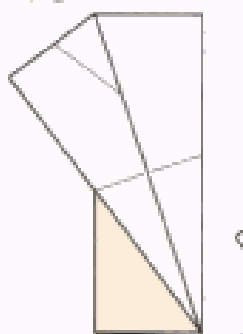

Unfold the back.

11

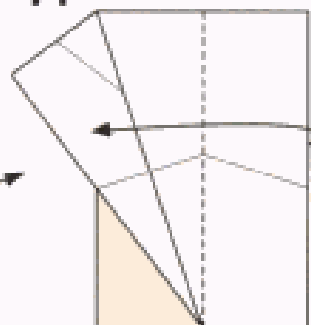

12

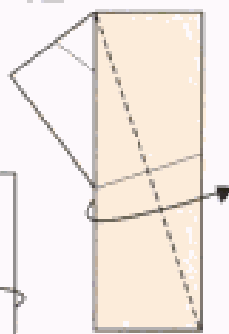

Fold only the upper layer.

13



14

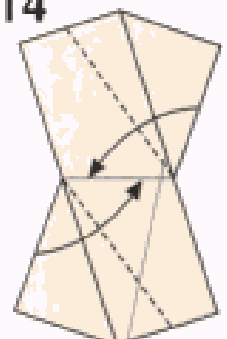

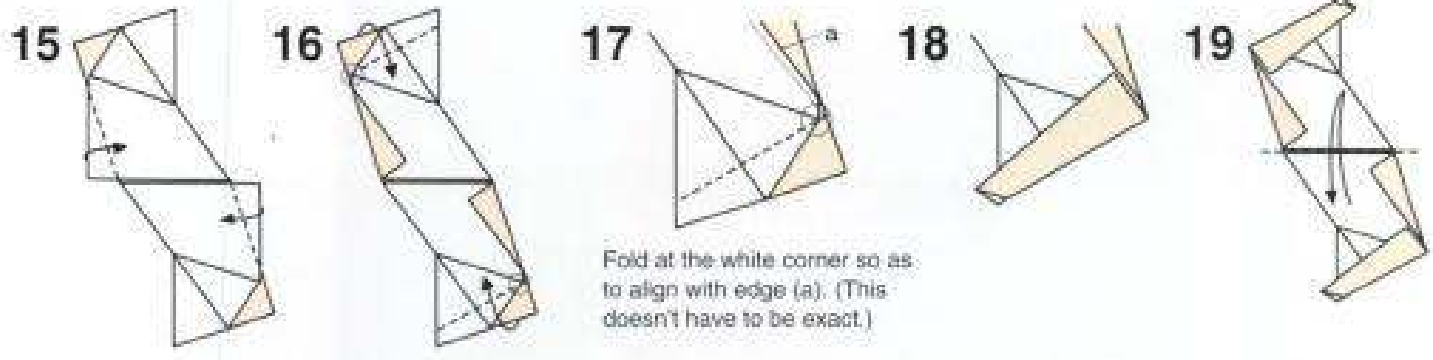

Fold at the white corner so as to align with edge (a). (This doesn't have to be exact.)

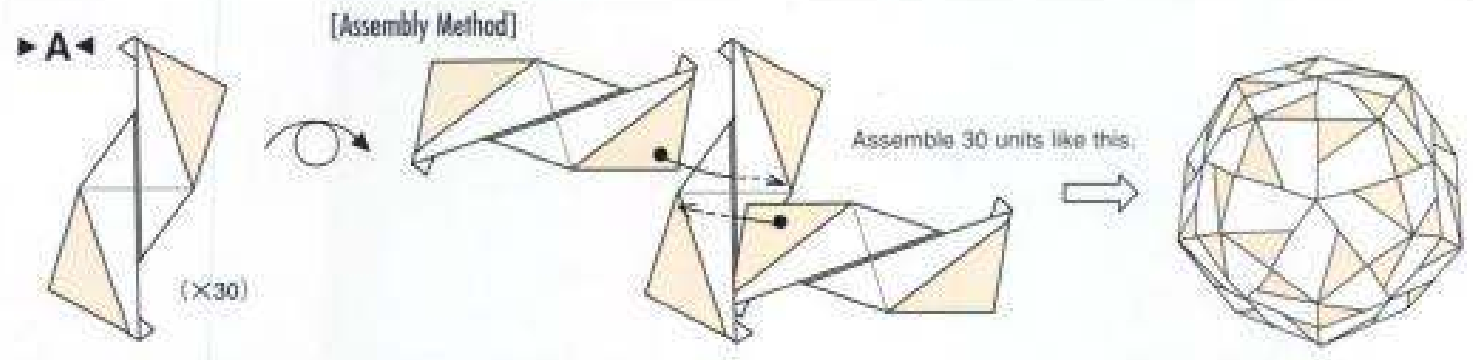

CHANGE PATTERNS

Starting with step 15, fold in the same way as in step 16.

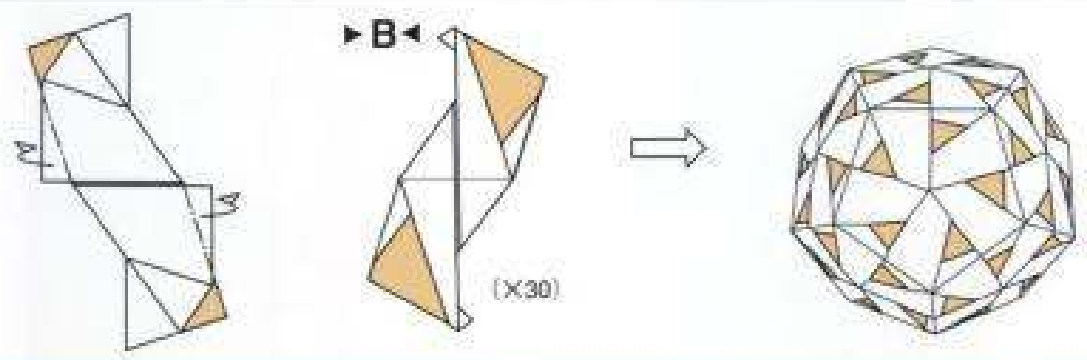

4

REGULAR HEXAGONAL FLAT UNITS

There are two kinds of hexagonal flat units: one has 3 pockets on its 6 sides and the other has 6 pockets. Join the units with other elements, and create larger, more complex figures.



TRUNCATED TETRAHEDRON /p.36



USING REGULAR HEXAGONAL FLAT UNITS WITH 3 POCKETS (1) /p.38

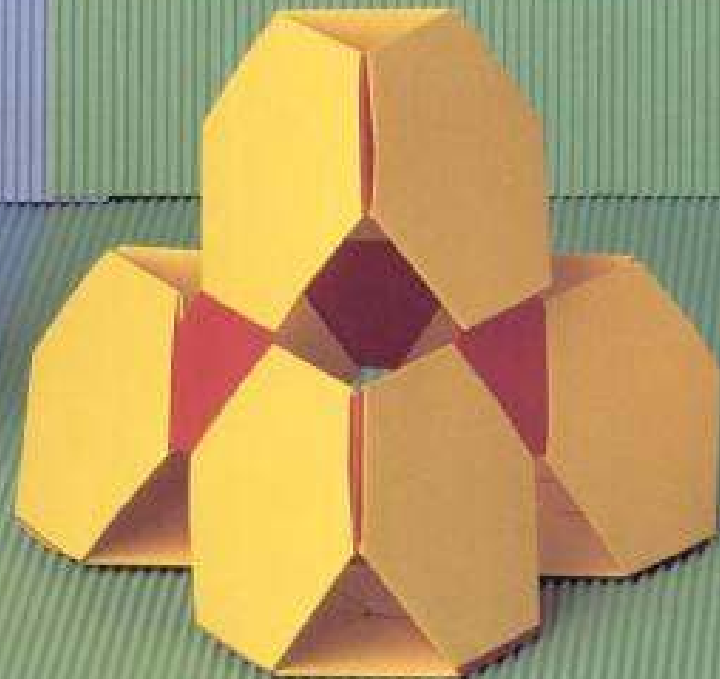

TRUNCATED OCTAHEDRON /p.36

**USING REGULAR HEXAGONAL
FLAT UNITS WITH 3 POCKETS (2) /p.40**



TRUNCATED ICOSAHEDRON /p.37



**USING REGULAR
HEXAGONAL FLAT UNITS
WITH 6 POCKETS
(TRUNCATED OCTAHEDRON) /p.43**



**USING REGULAR HEXAGONAL FLAT UNITS
WITH 6 POCKETS (TRUNCATED TETRAHEDRON) /p.42**

REGULAR HEXAGONAL FLAT UNIT • 3 POCKETS

level ★★

12cm × 12cm

1

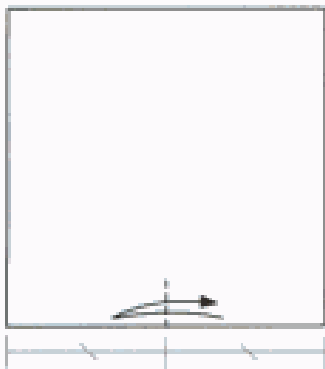

Make a short crease on the lower side.

2

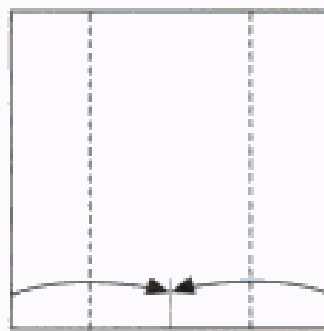

3

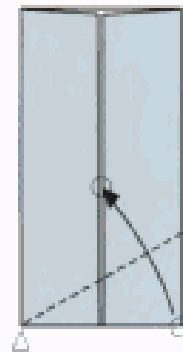

Fold so as to join the two circles ○, using the corner △ as the pivot.

4

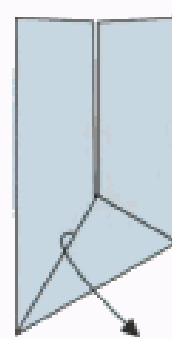

5

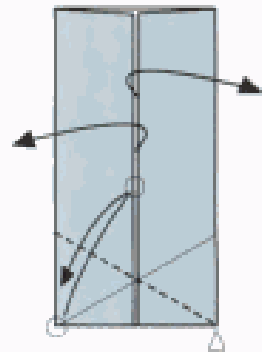

Make a crease and unfold.

6

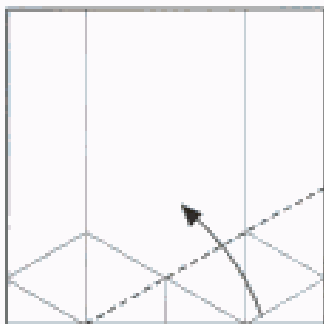

7

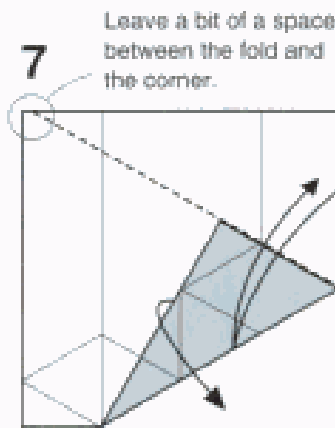

Make a crease and unfold.

8

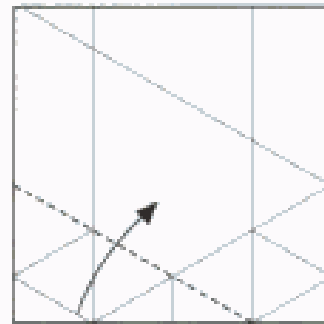

9

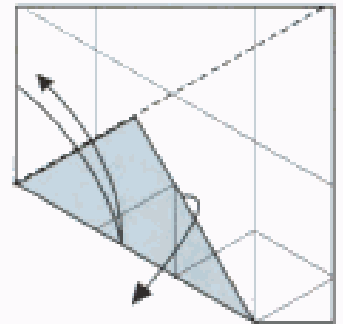

Make a crease and unfold.

10

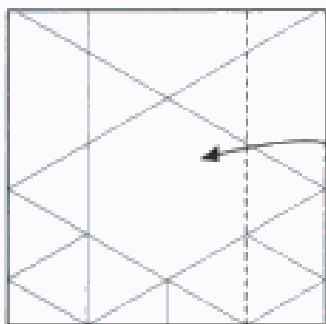

11

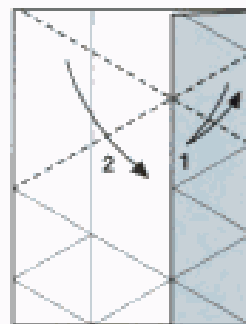

Fold in numerical order.

12

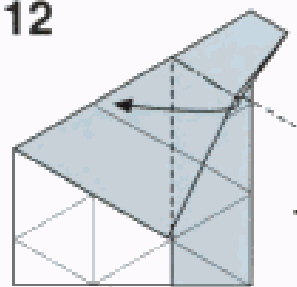

14

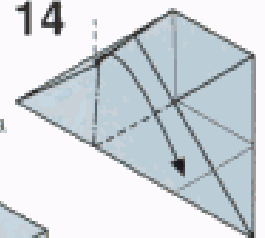

13

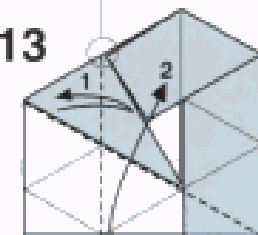

Fold in numerical order.

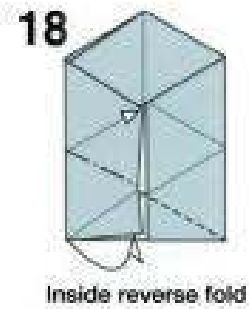
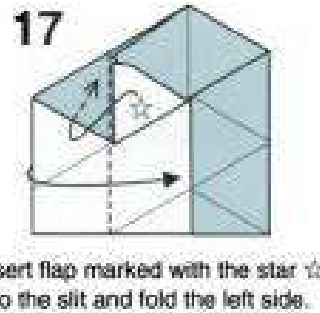
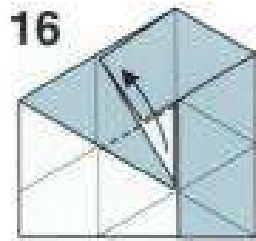
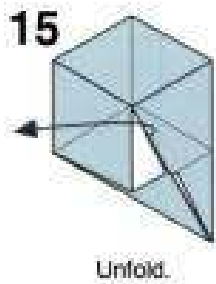

Be sure that the part marked with the triangle is securely tucked in.

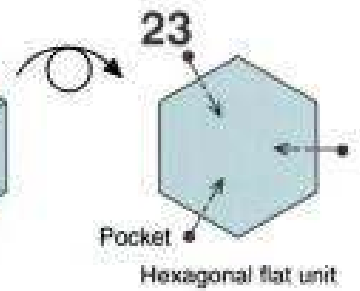
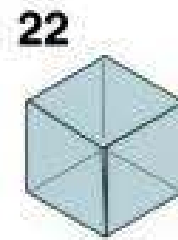
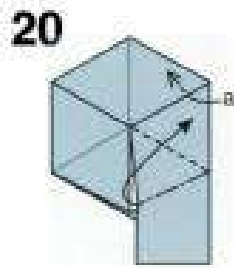
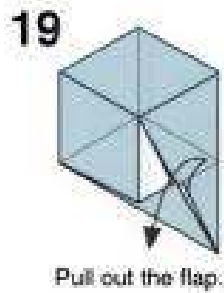

Simple Form

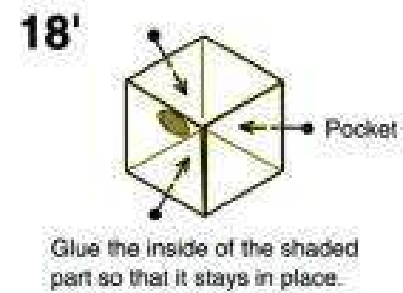
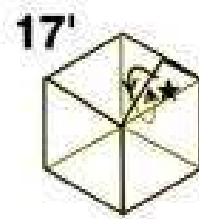
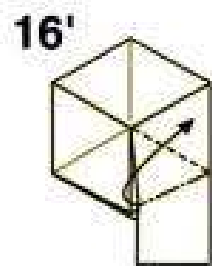
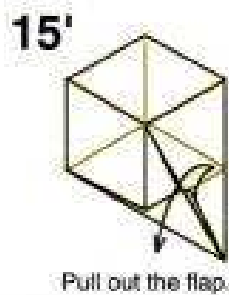

Joint C

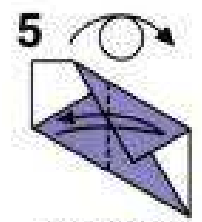
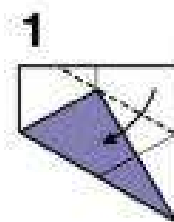
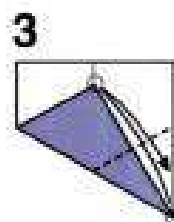
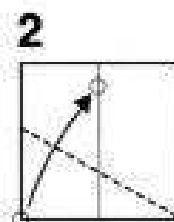
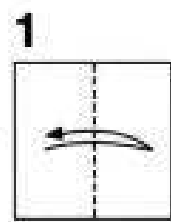
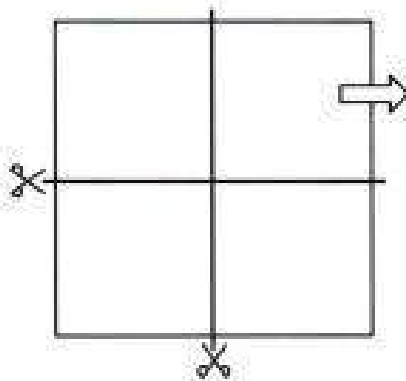

Fold in half on the crease.

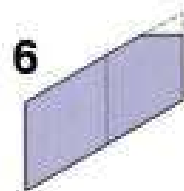

The corner is missing from the joint, but this is not a problem. Insert it in any direction you like.

[Assembly Method]

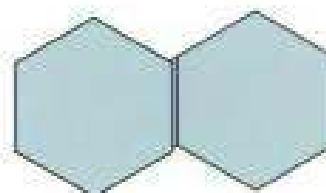
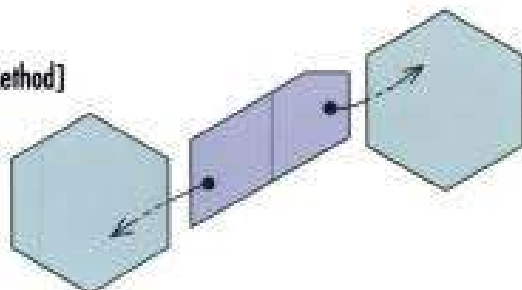

TRUNCATED TETRAHEDRON AND OCTAHEDRON

level ★

12cm × 12cm

Hexagonal flat unit (p. 34)

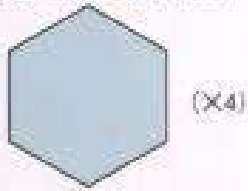

Joint C (p. 35)

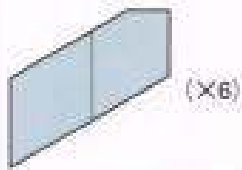

Hexagonal flat unit (p. 34)

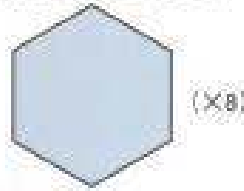

Joint C (p. 35)

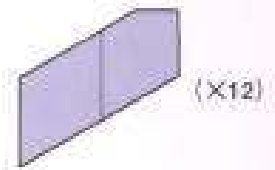

The finished work appears to have "windows."

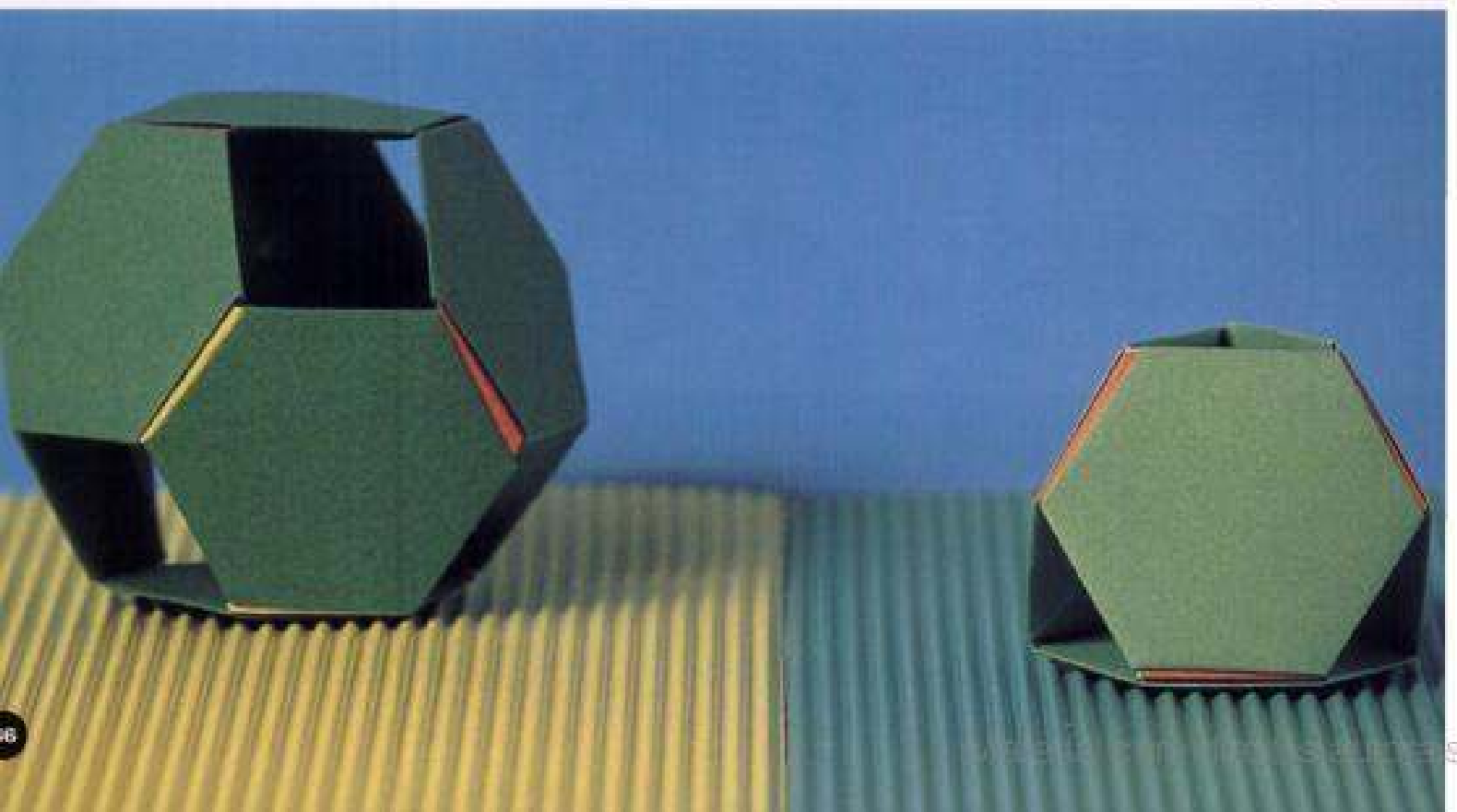
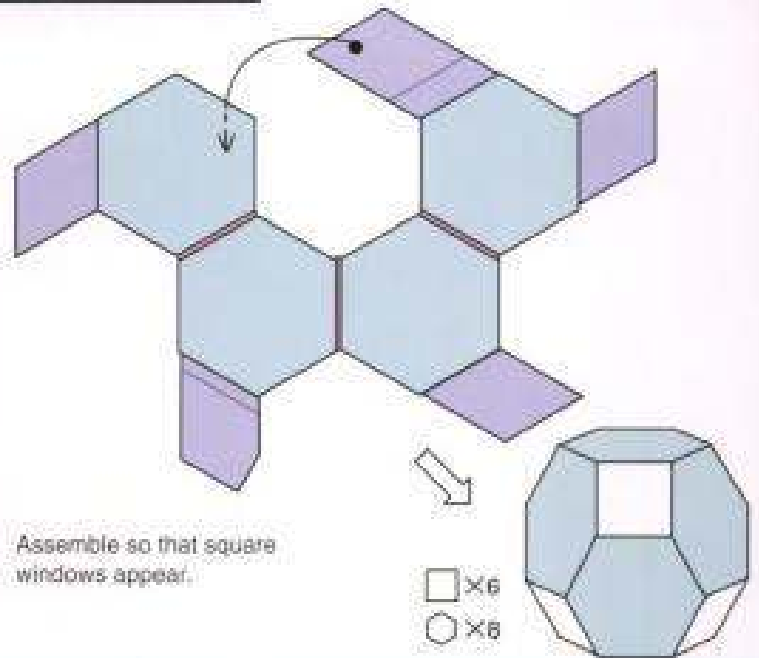
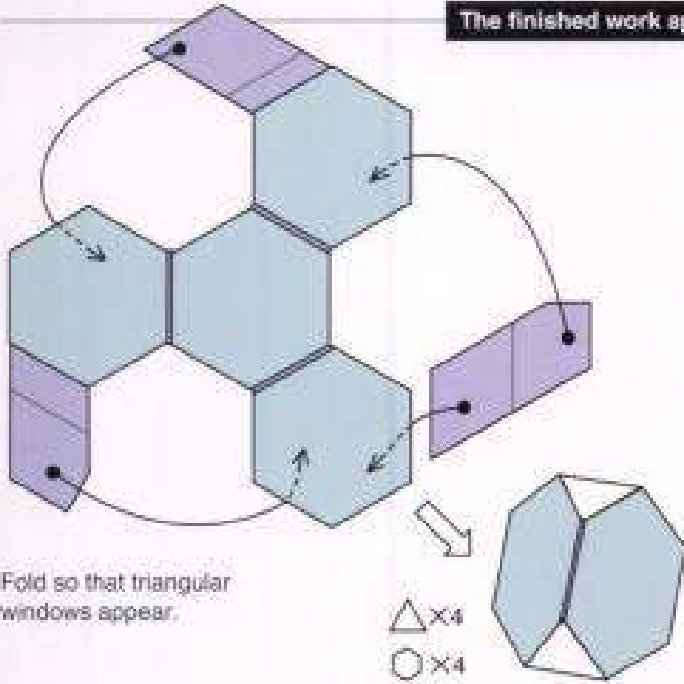

TRUNCATED ICOSAHEDRON

level ★

10cm × 10cm

Hexagonal flat unit (p. 34)

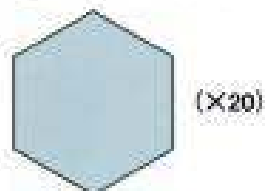

Joint C (p. 35)

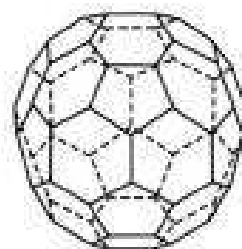
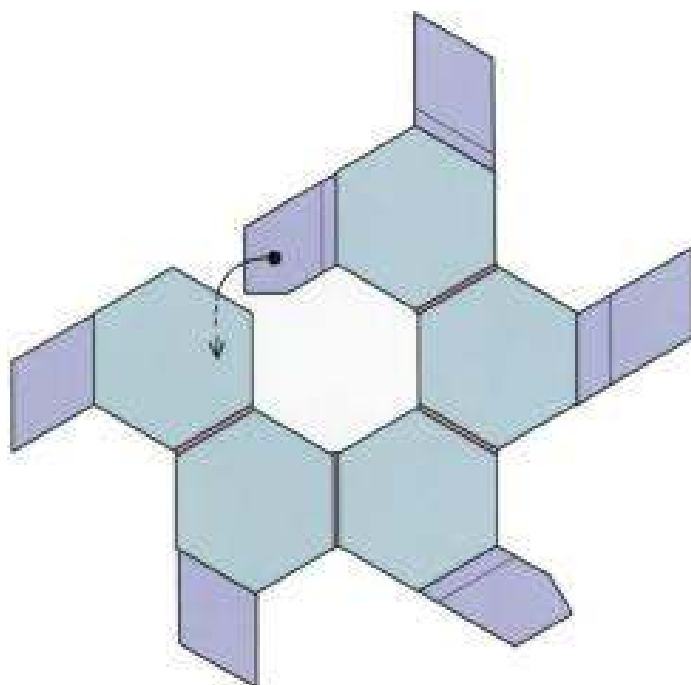
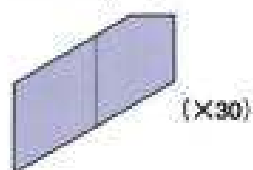

⬠ × 12 ○ × 20



Assemble so that pentagonal windows appear.



Triangle Element A

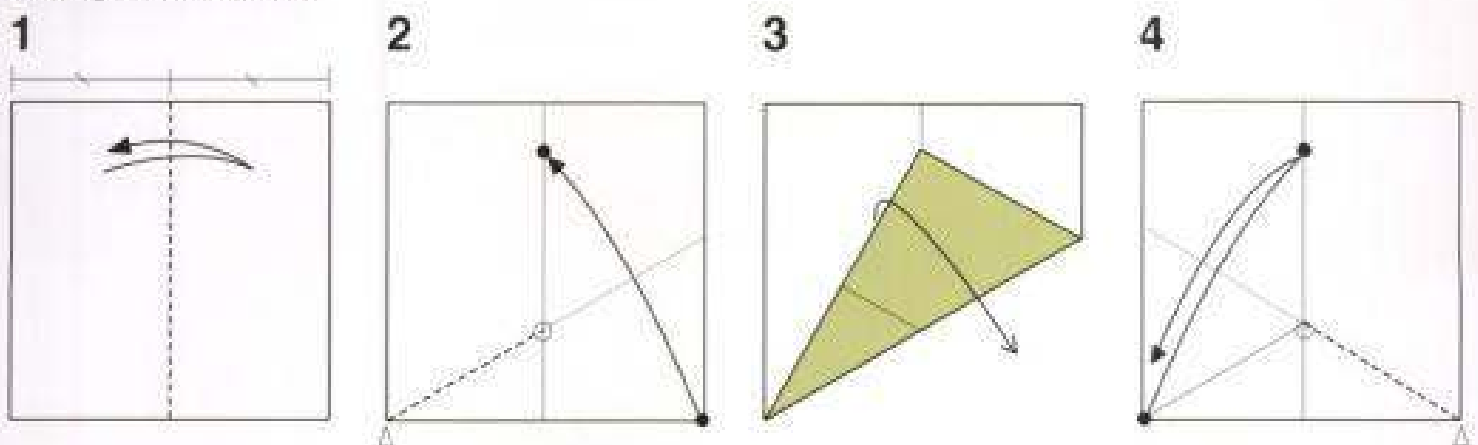

Fold the corner marked with the black dot up to the other black dot, using the corner marked with a triangle as the pivot.

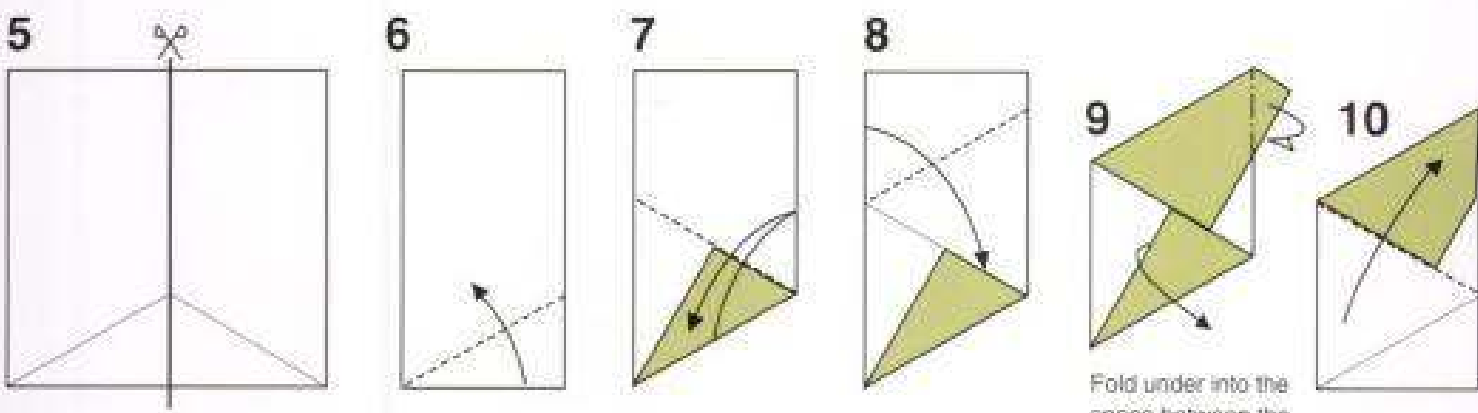

Cut in half.

Fold under into the space between the two layers.

[Assembly Method]

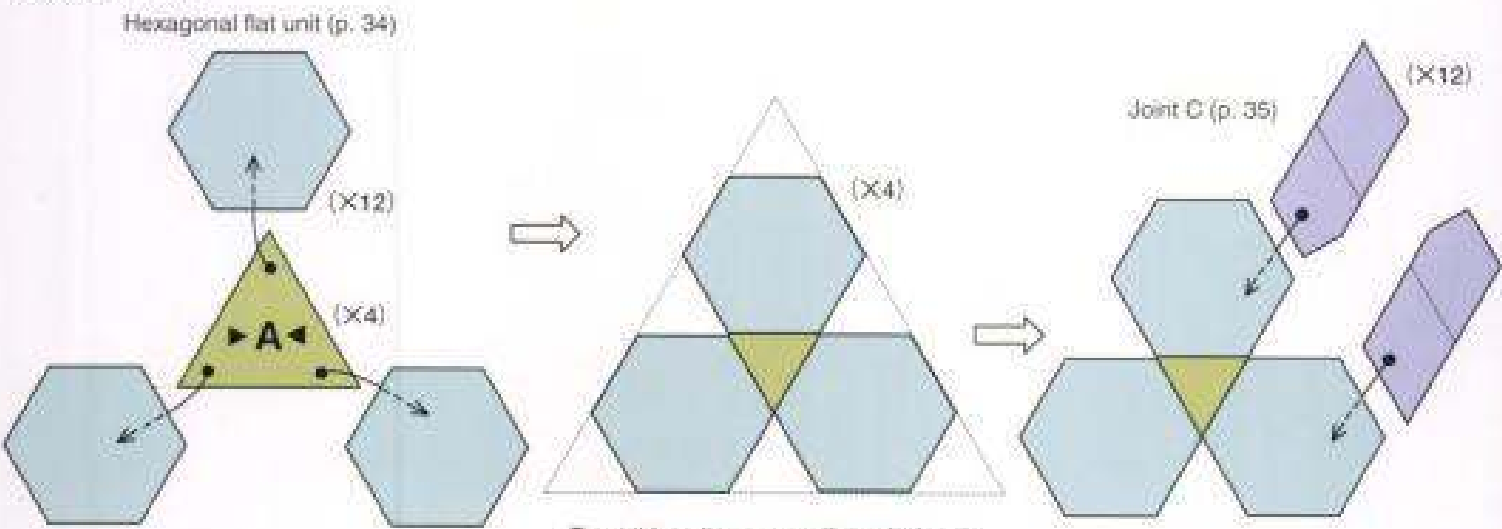

Treat this unit as an equilateral triangle when you assemble the figure.

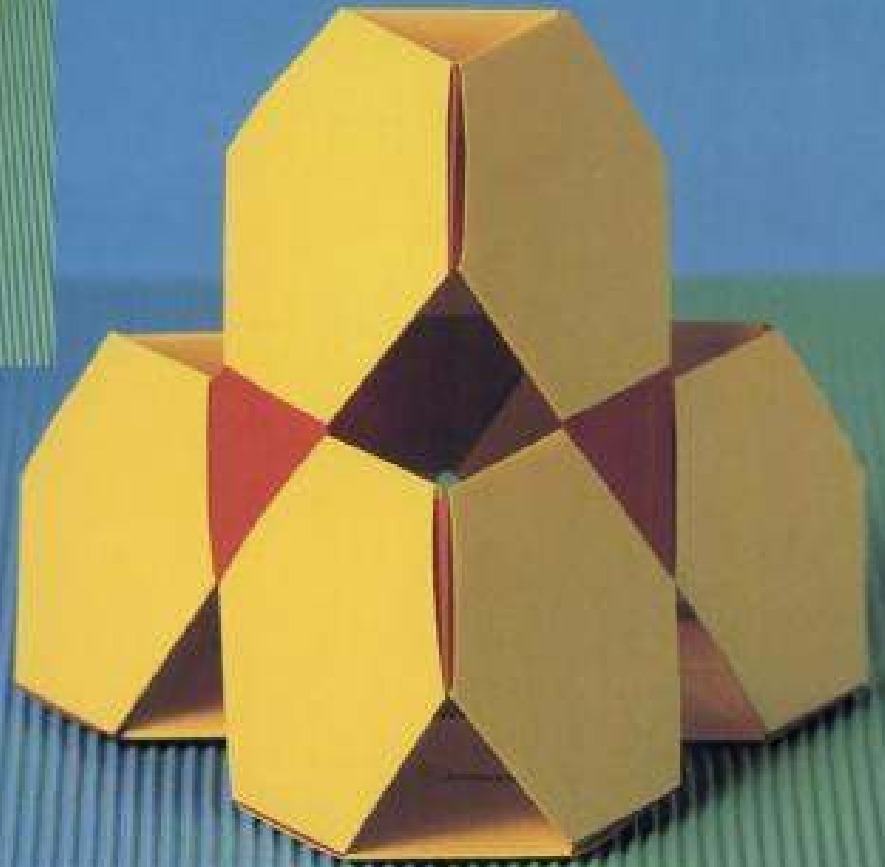
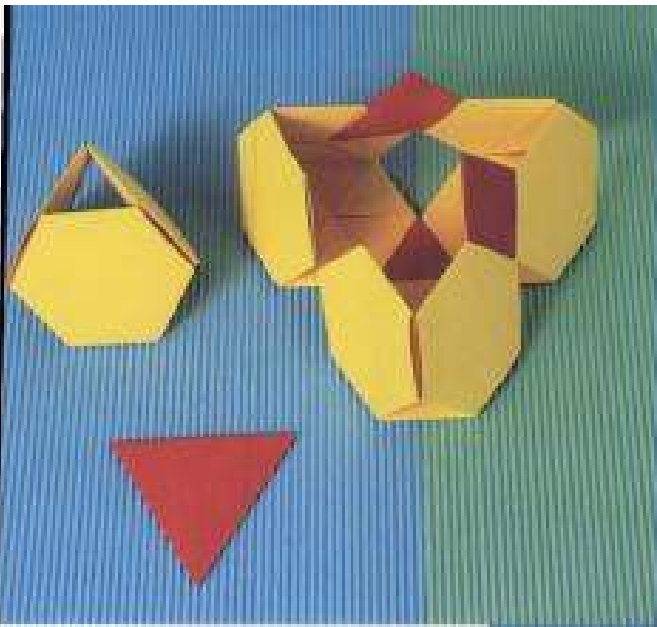

11 Insert in between the two layers.

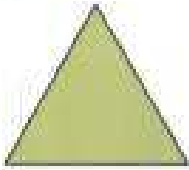
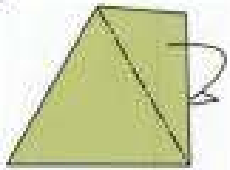

(X4)

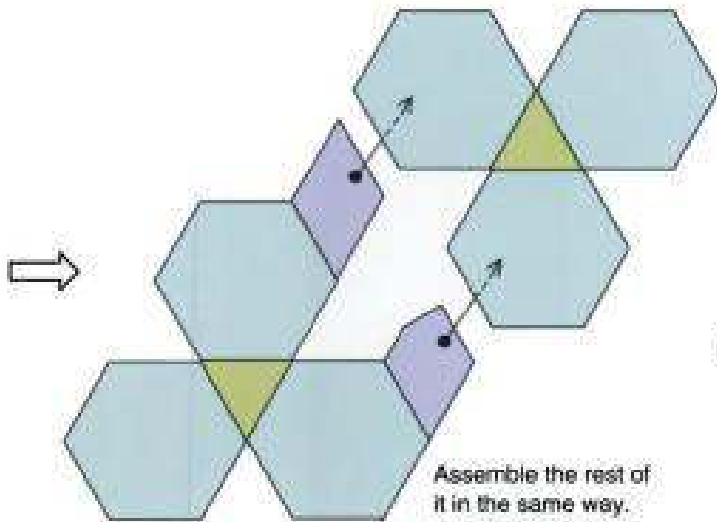

Assemble the rest of it in the same way.

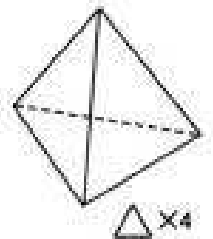
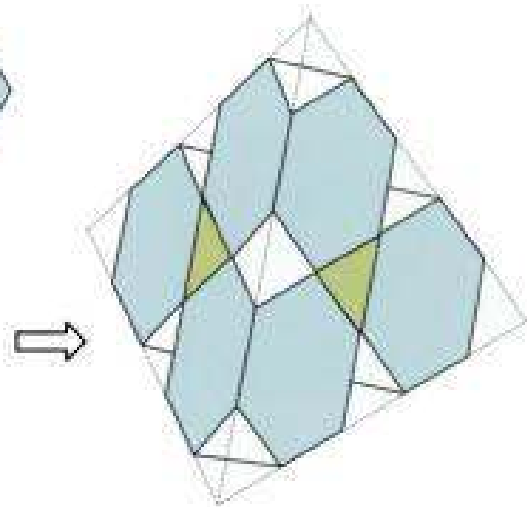

Triangle Element B

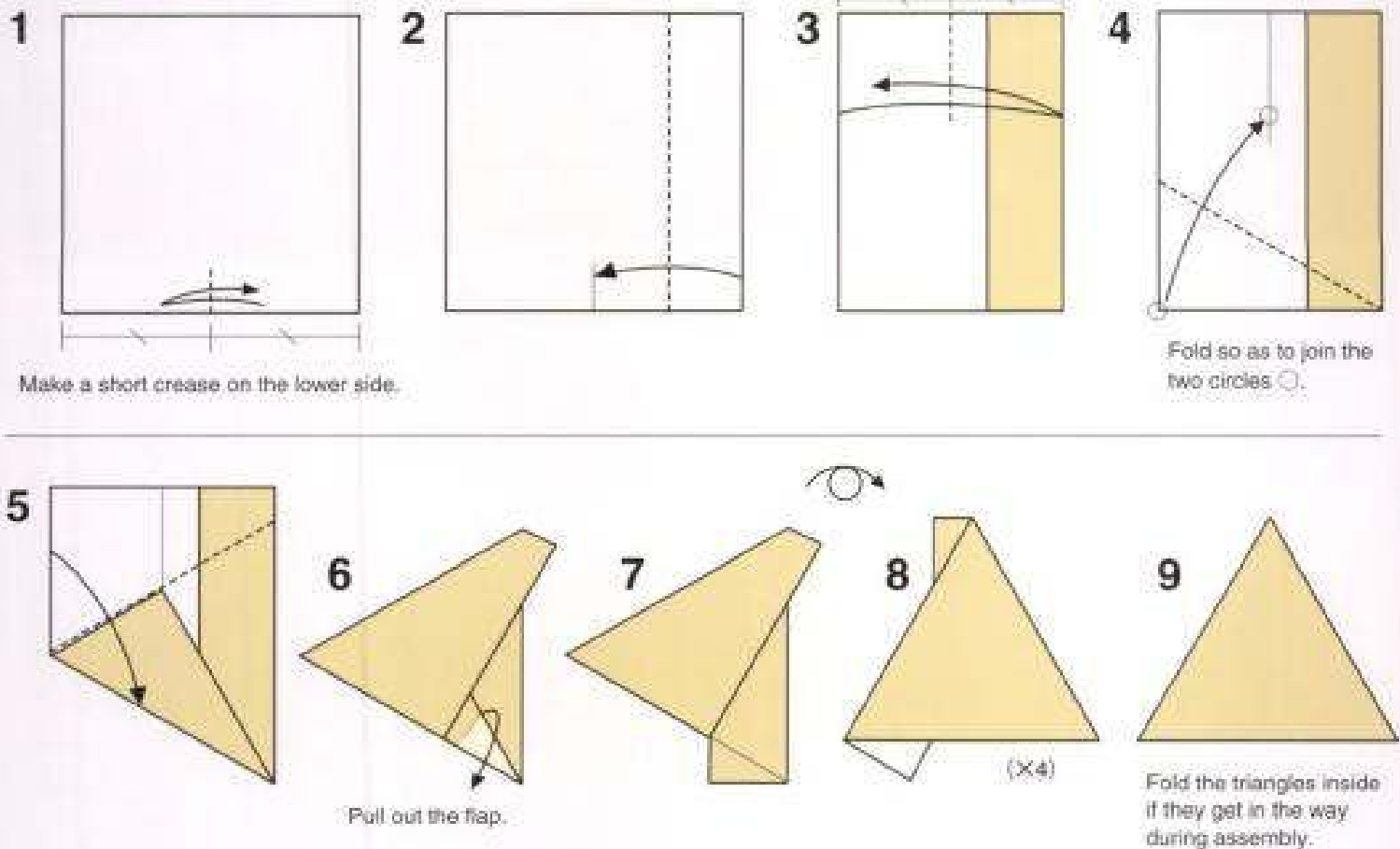

[Assembly Method]

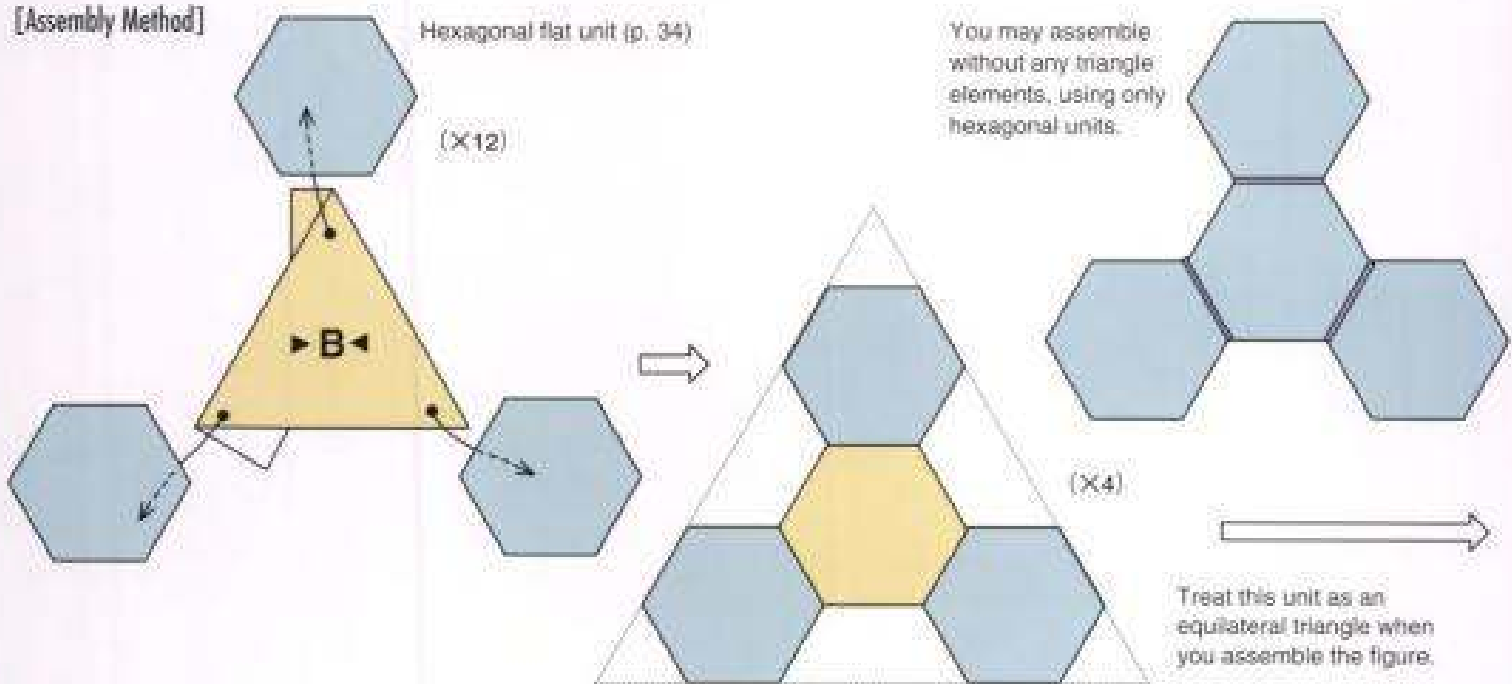

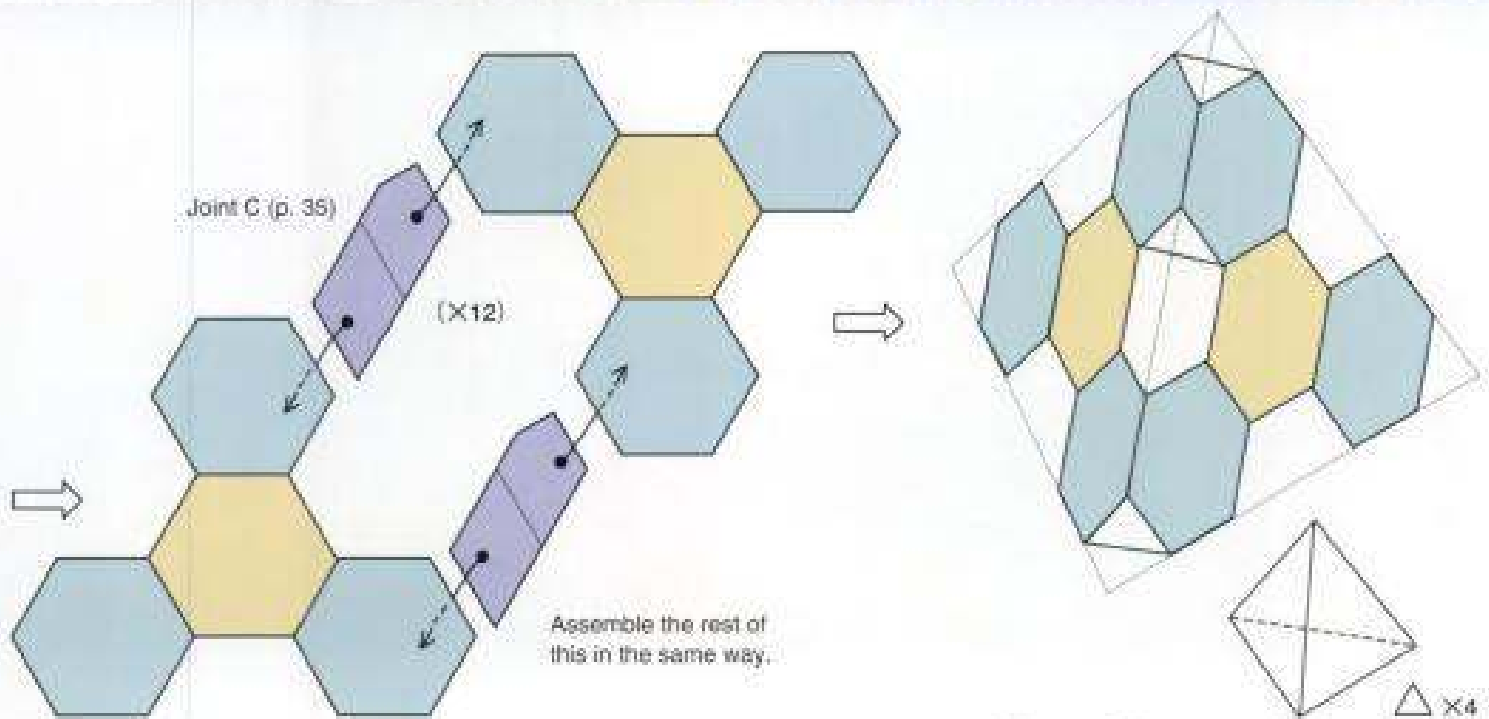
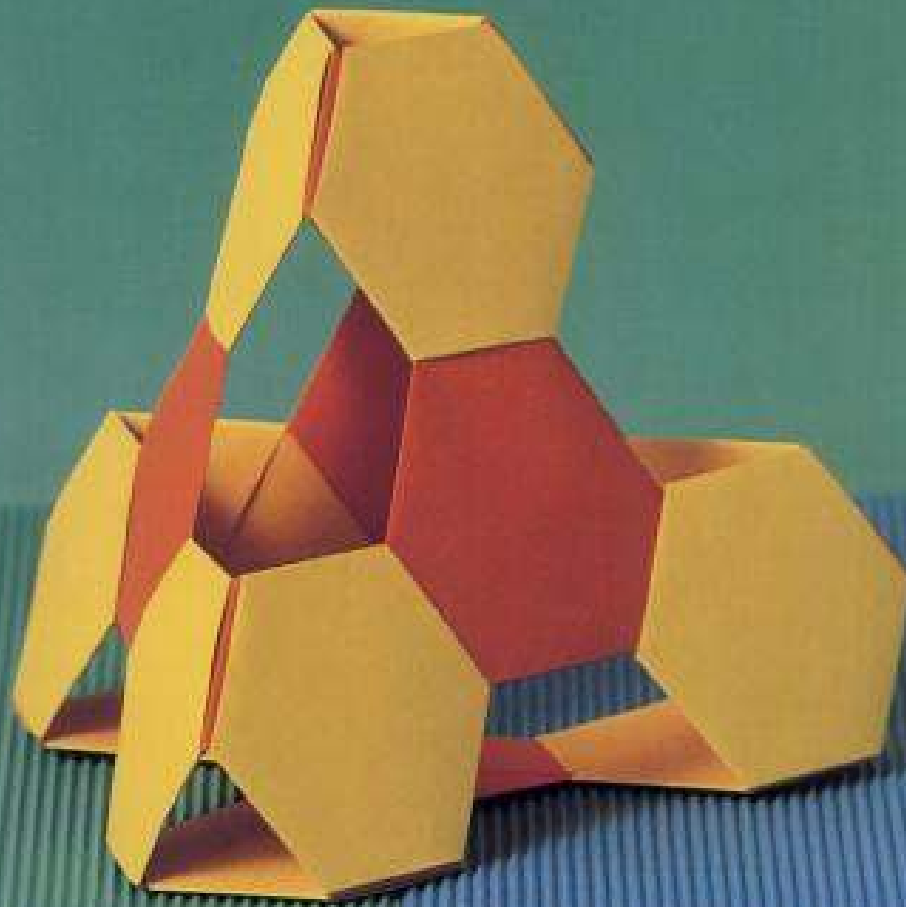

Regular Hexagonal Flat Unit USING 6 POCKETS

level ★★

12cm × 12cm

Now you will learn to make structures with two units stacked on top of each other.

Using this unit, you can make the solids shown on pp. 38-41 without windows. You can also use it on p. 36.

Hexagonal Flat Unit (Simple Form) (Starting from step 16' on p. 35)

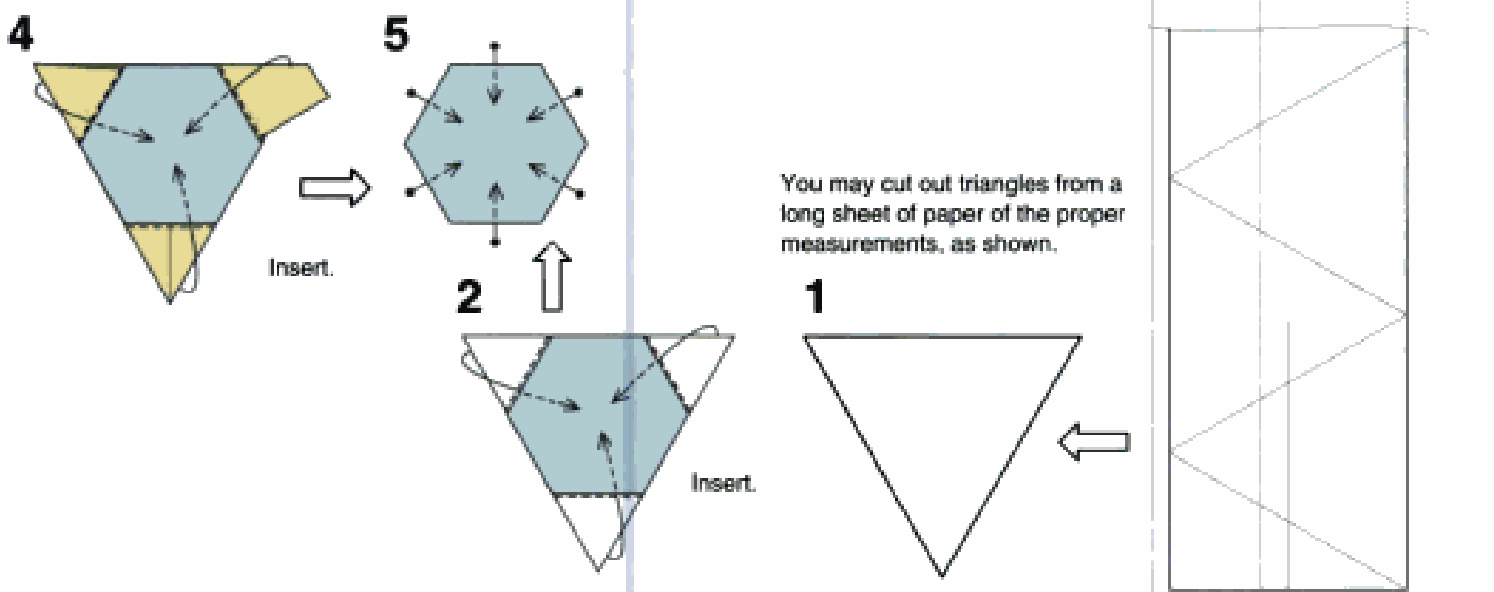
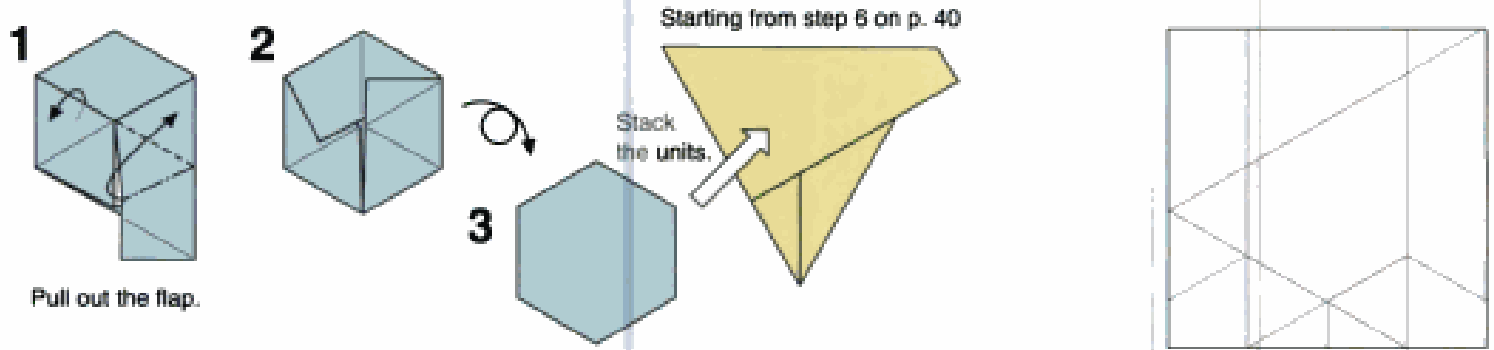

Triangle Element C

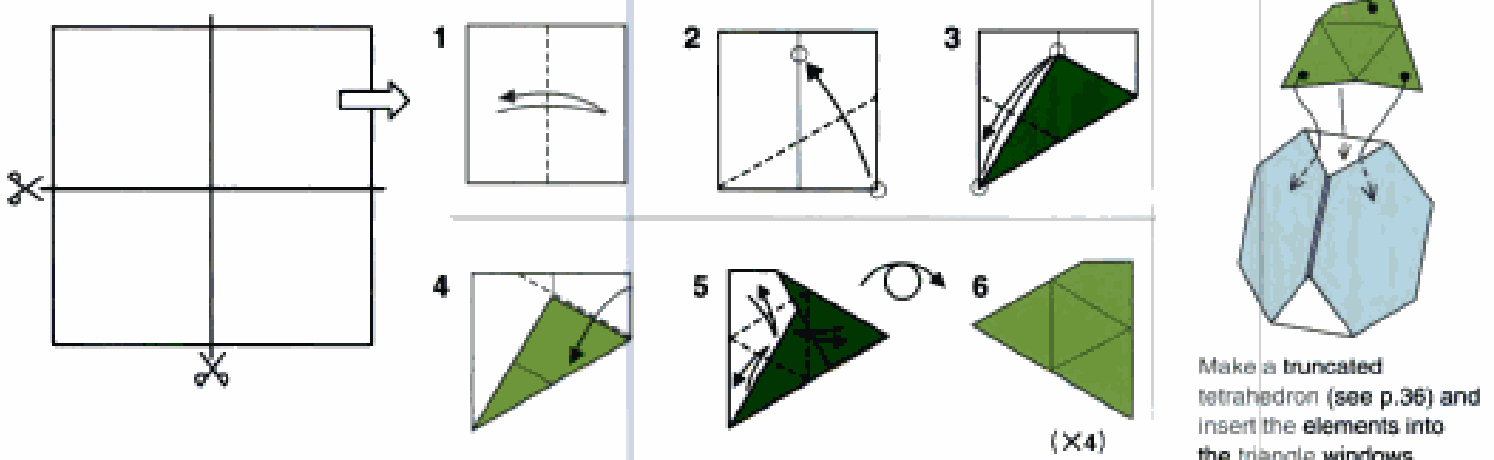

TETRAHEDRON

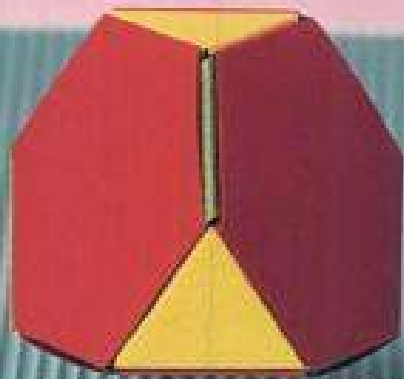

OCTAHEDRON

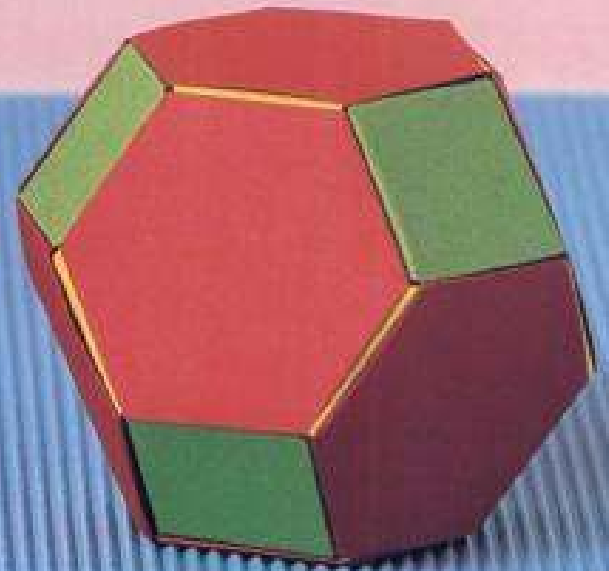

Square Element

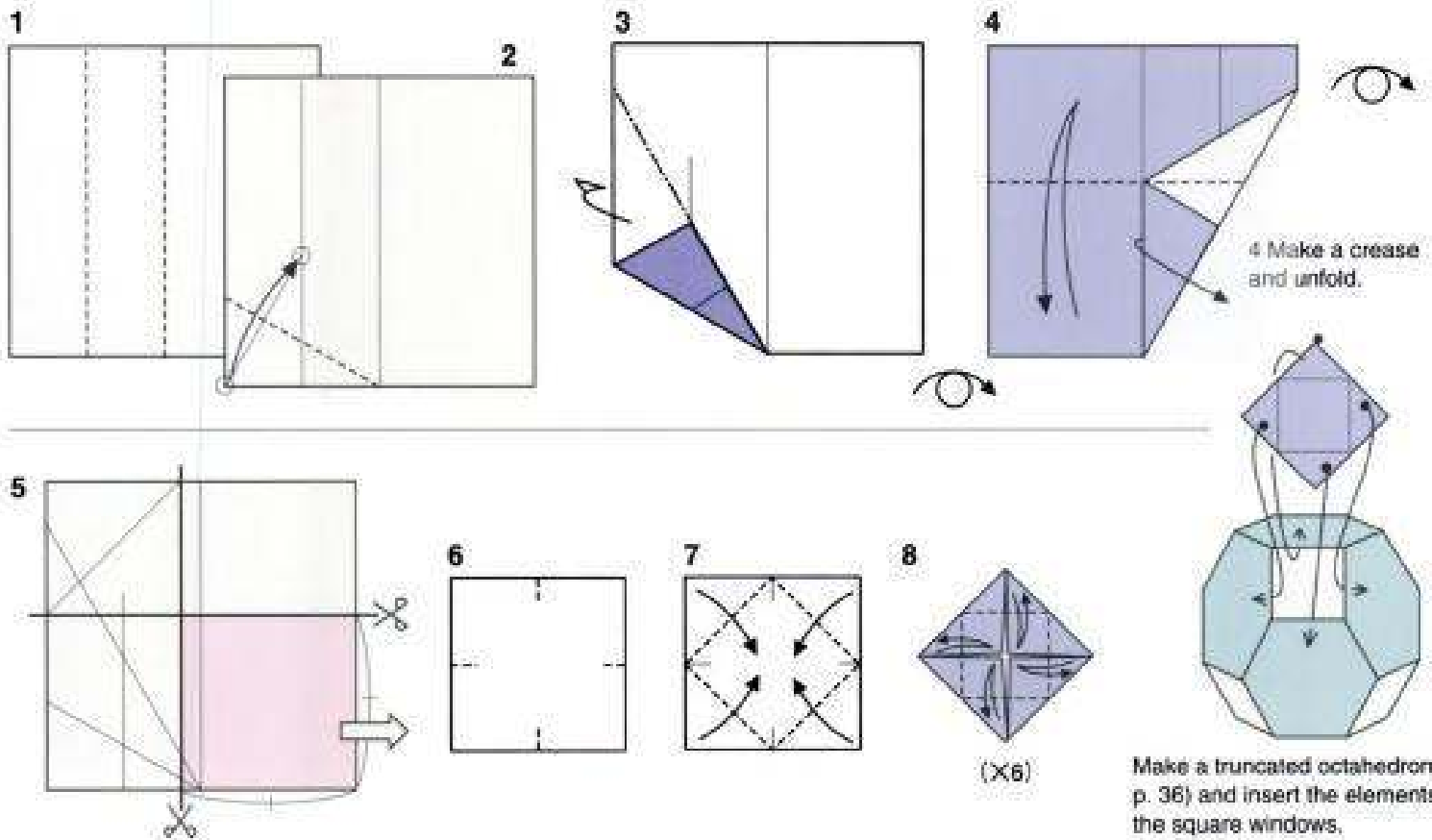

5

EDGE CUBES

These cubes are assembled by connecting them at twelve places. There are square or star-shaped windows in the middle of each surface. Modifying the folds and measurements changes the cubes and the size of the windows.

STAR-SHAPED WINDOWS • Large /p.48



STAR-SHAPED WINDOWS • Medium /p.51

SQUARE WINDOWS • Medium /p.45



SQUARE WINDOWS • Large /p.47

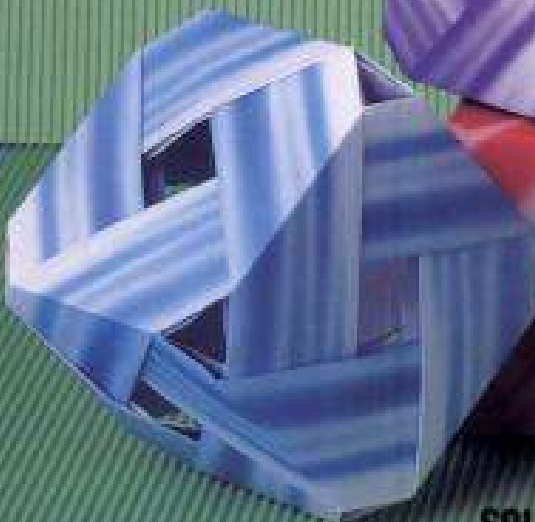

SQUARE WINDOWS • Small /p.46

STAR-SHAPED WINDOWS • Small /p.50



This cube is assembled by joining the sides. Changing the folds and the measurements changes the size of the windows.

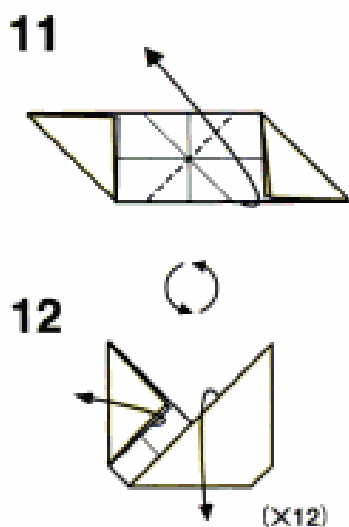
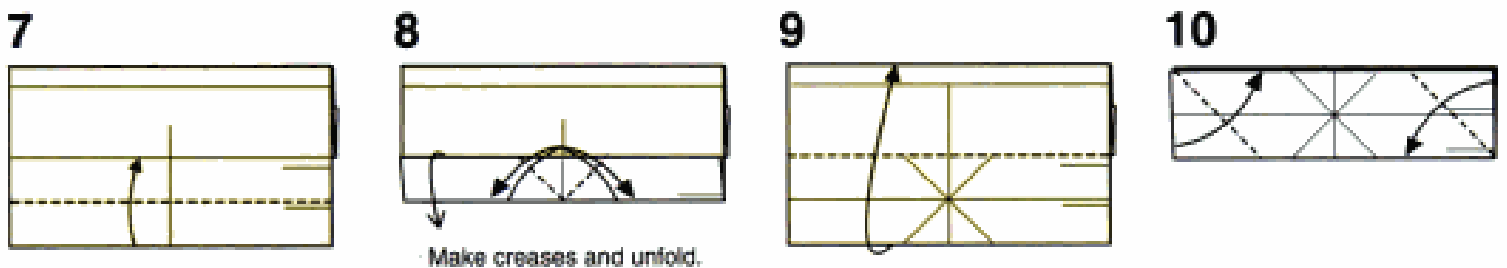
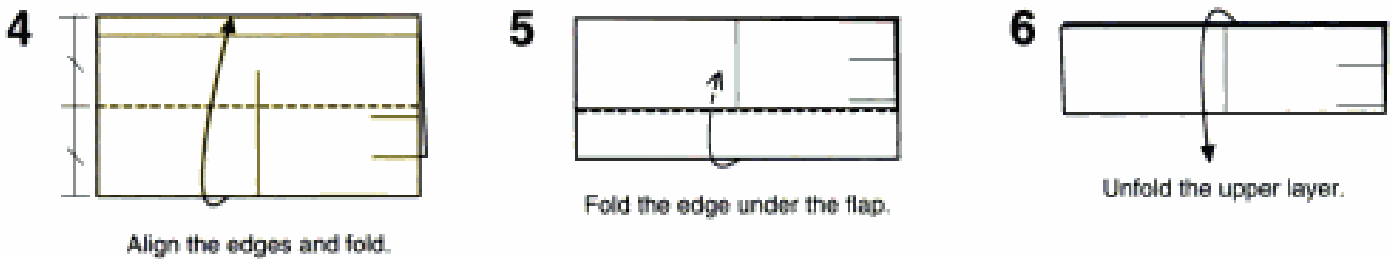
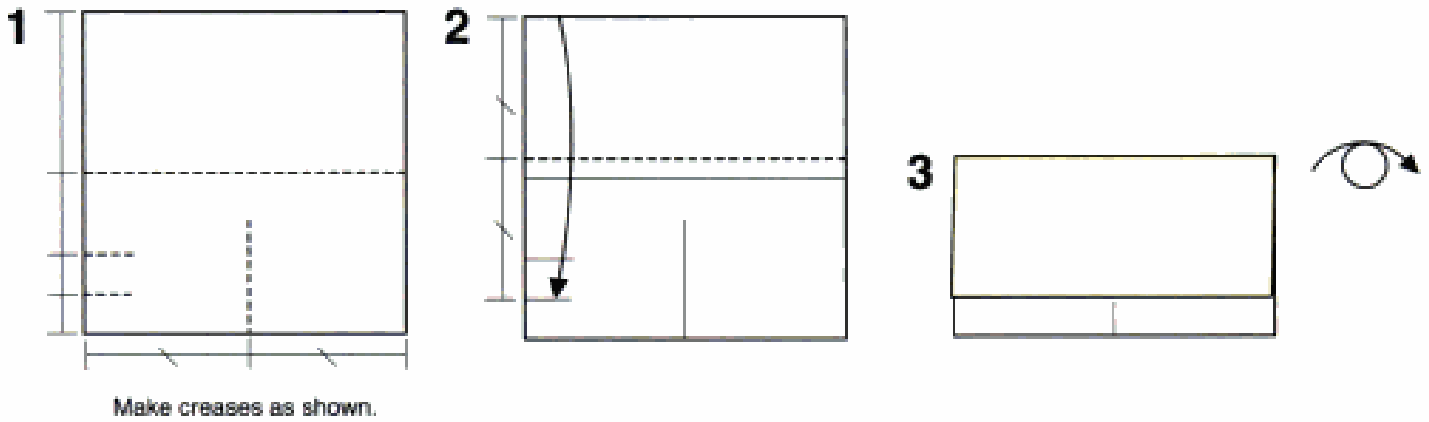

[Assembly Method]

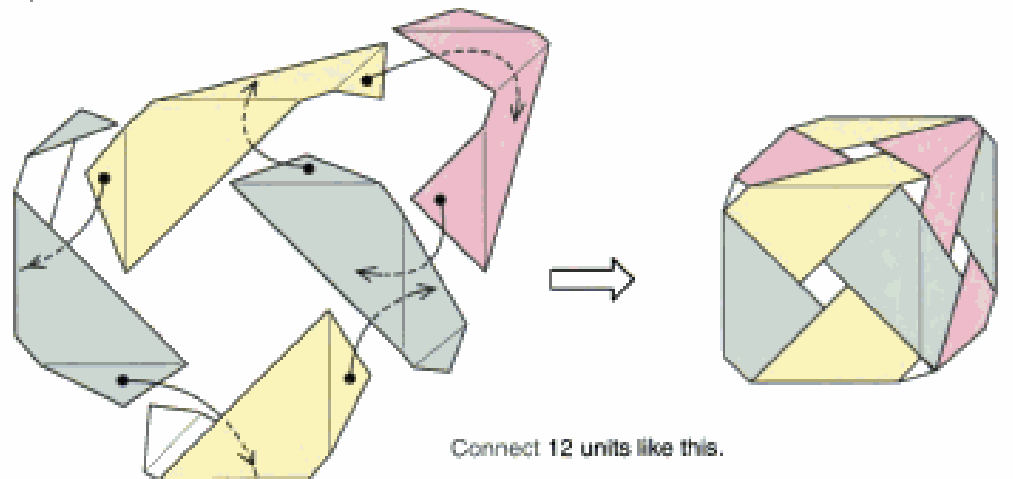

A cube assembled by connecting sides. Changing the folds and the measurements changes the size of the windows.

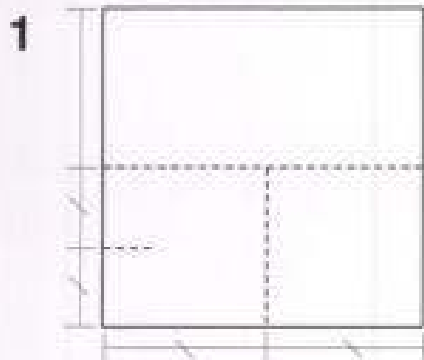

Make creases as shown.

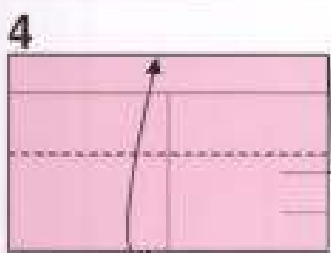
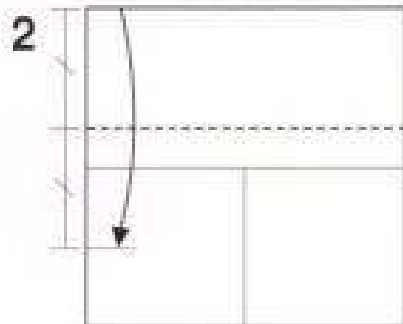

Align edges and fold.



Fold under the flap.

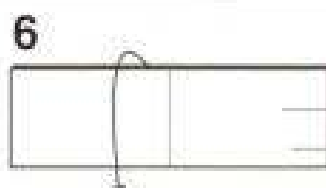

Unfold the upper layer.

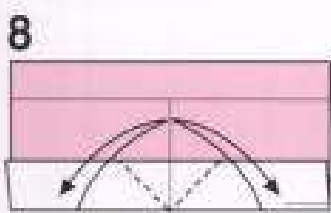
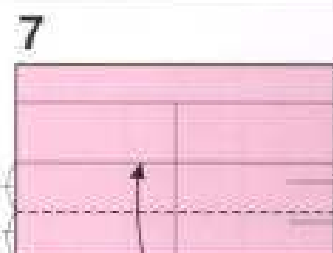

Make creases and unfold.

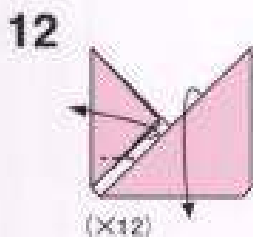
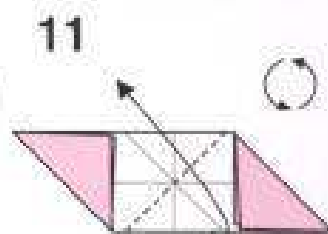
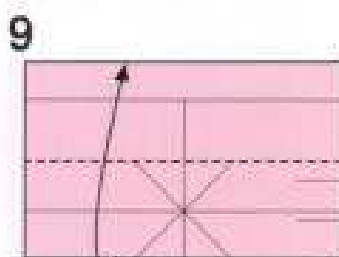

(×12)

Assemble in the same way as the medium cube. (p. 45)

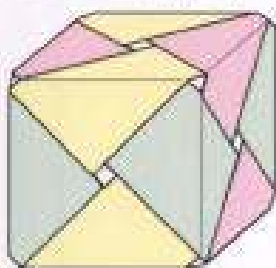

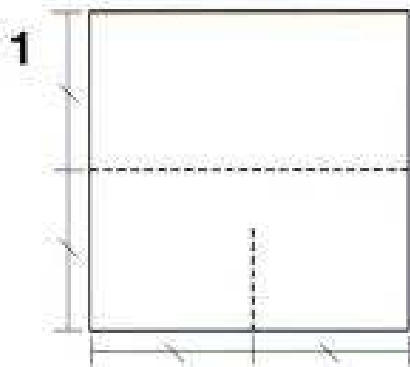

Make creases as shown.

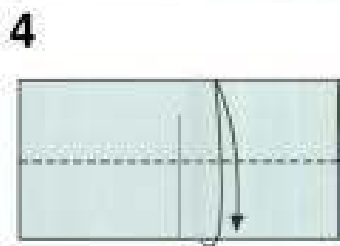
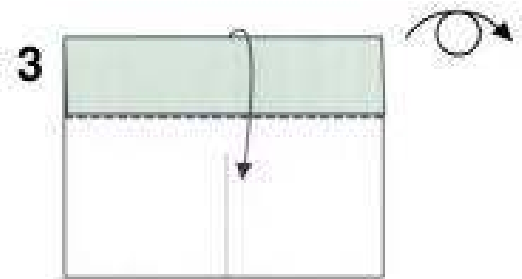
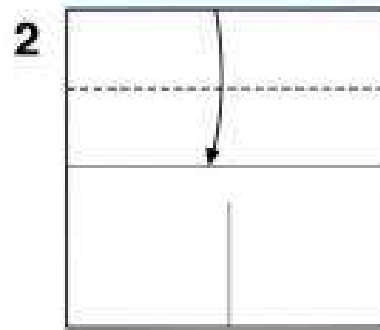

Align the edges and fold.

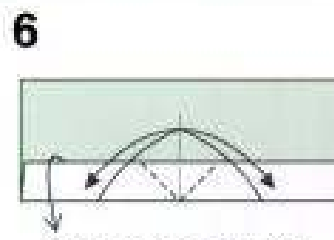
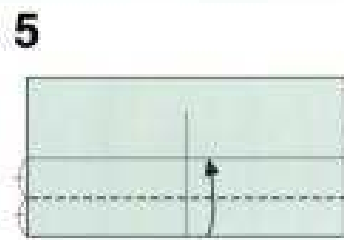

Make creases and unfold.

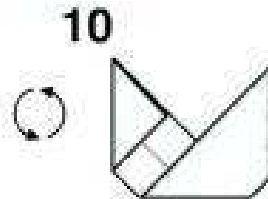
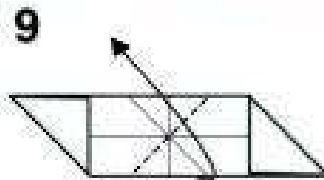
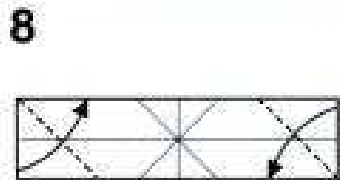
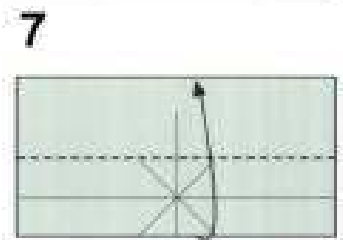

(X12)

Assemble in the same way as the medium cube: (p. 45)

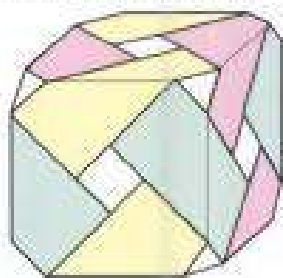

A cube with star-shaped windows. Changing the folds and the measurements changes the size of the windows.

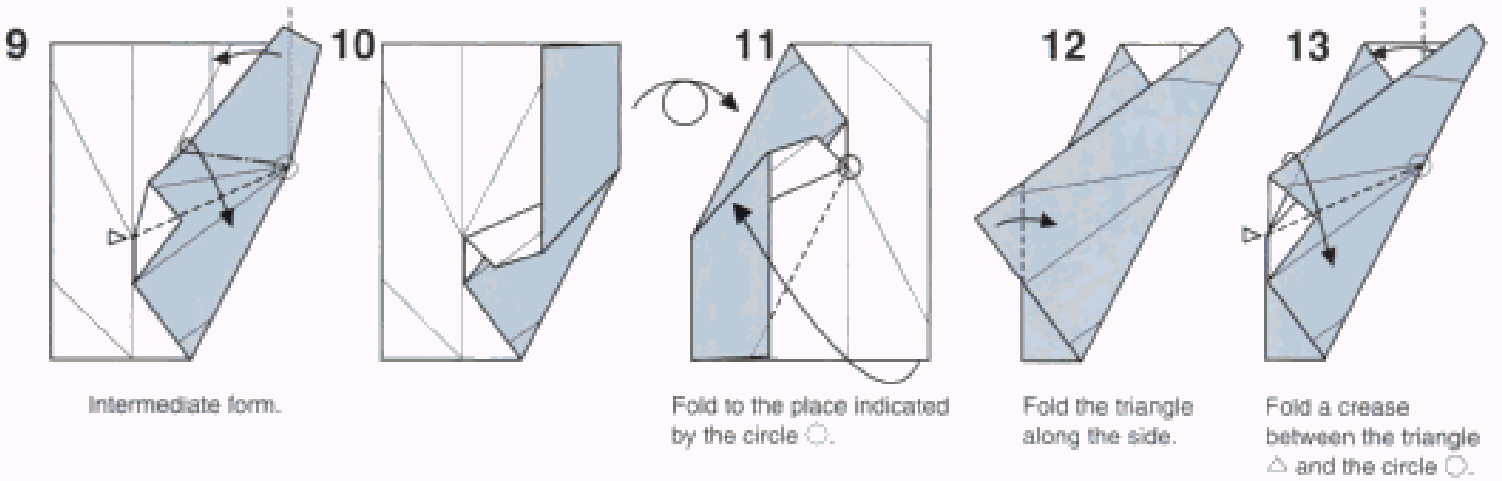
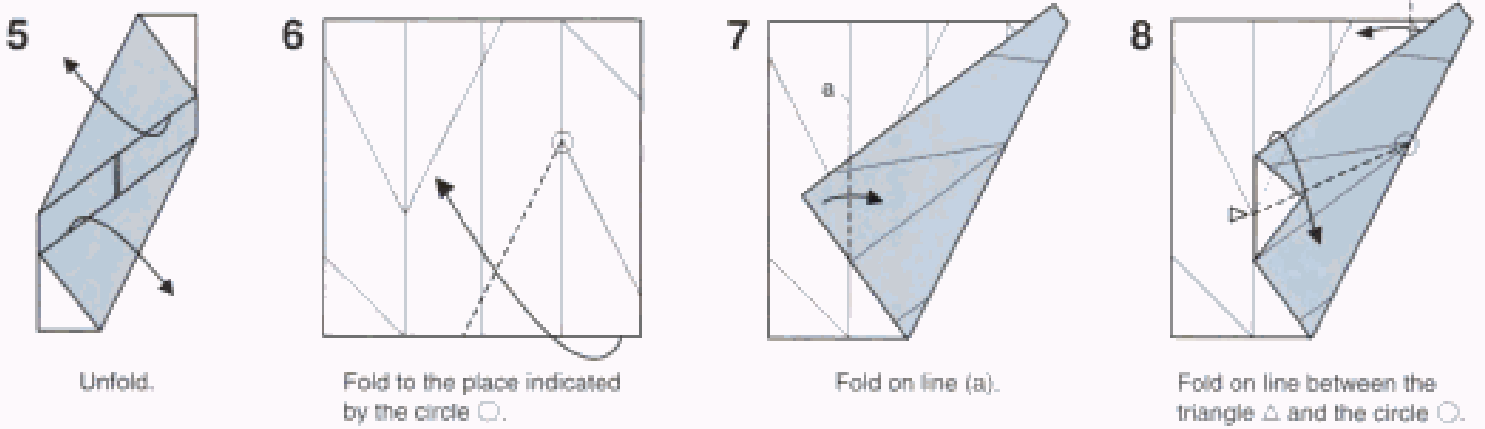
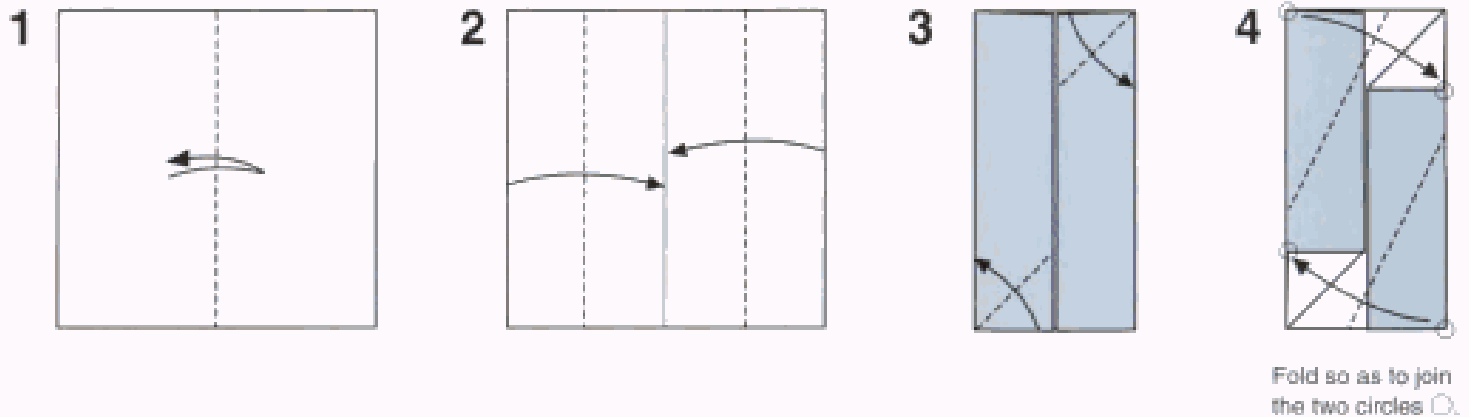

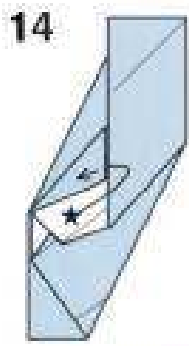

Tuck the tab marked with a star ★ inside the folds.

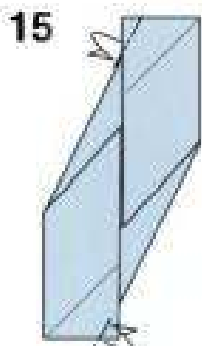

Fold the corner inward.

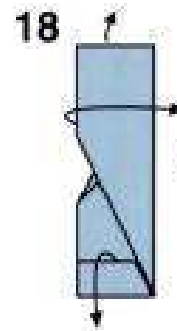
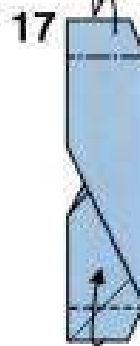
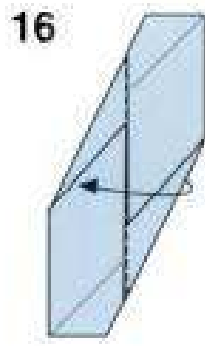

Unfold.



[Assembly Method]

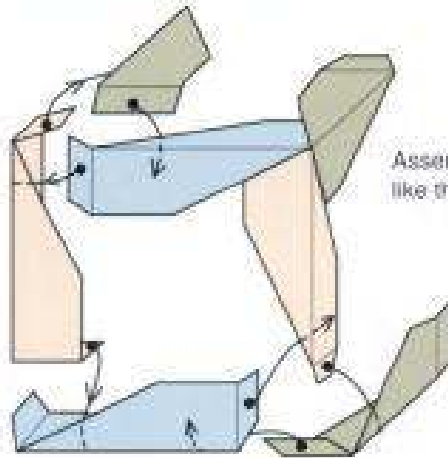
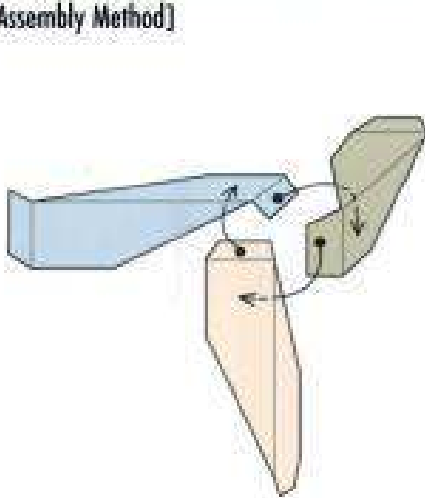

Assemble 12 units like this.

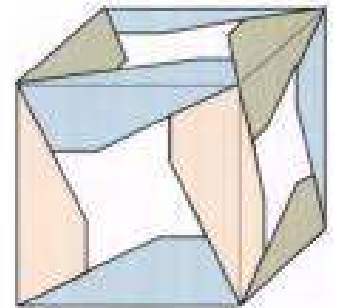

From step 4 on p. 48

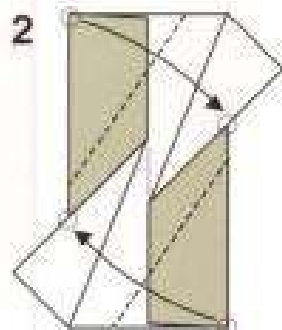
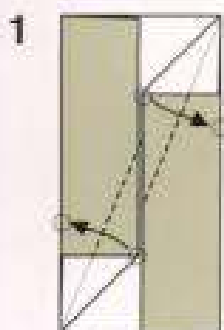

Fold so as to join the two circles ○.

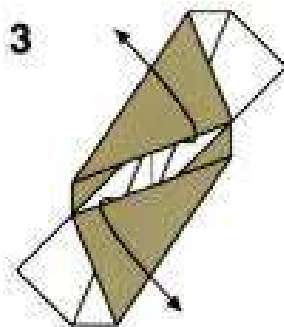

Unfold.

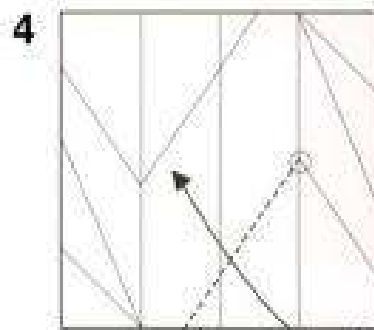

Fold to the place indicated by the circle ○.

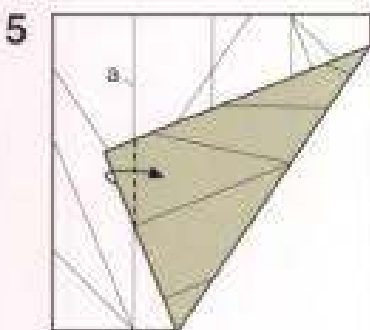

Fold on line (a).

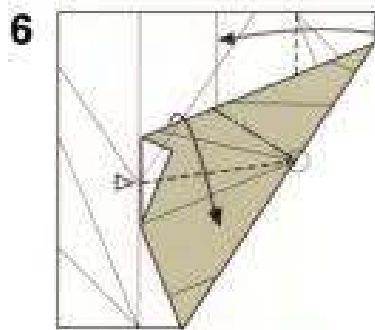

Fold on line between the triangle Δ and the circle ○.

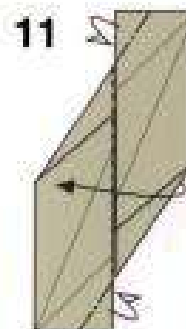
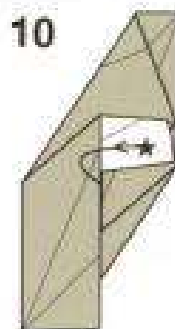
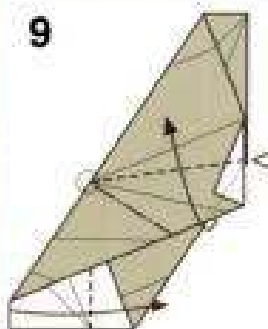
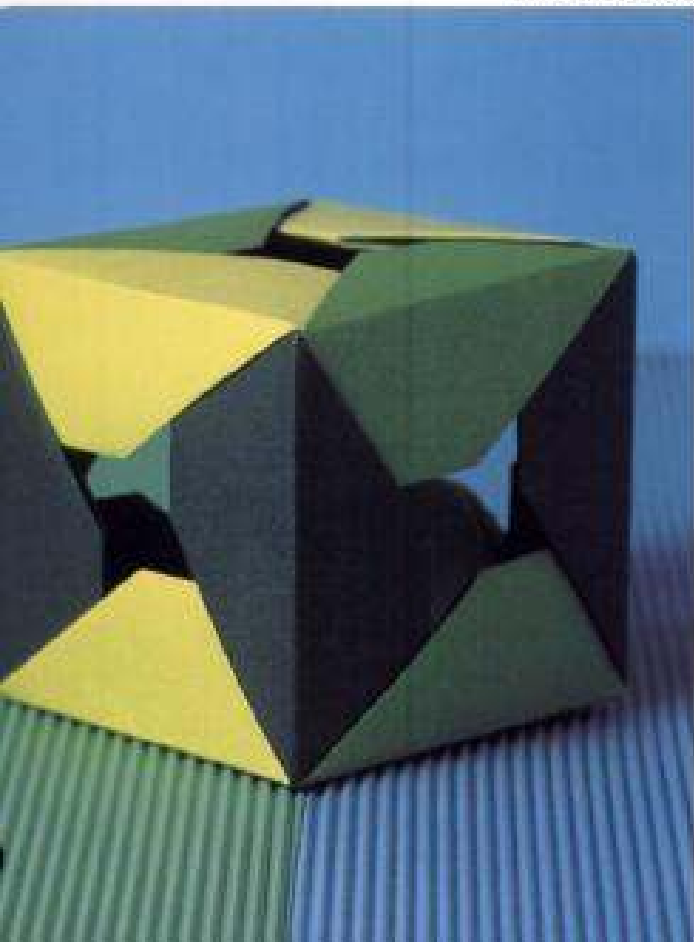
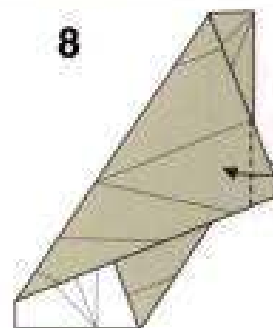
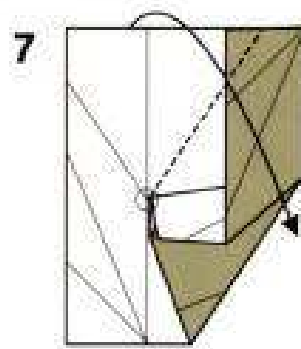

Tuck the tab marked with a star ★ inside the folds.

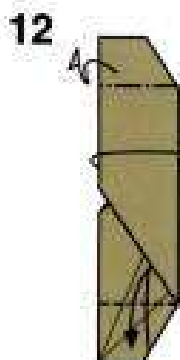

Make creases and unfold.

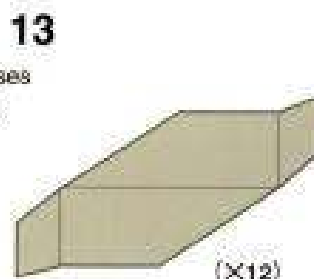

(×12)

Assemble in the same way as the large cube (p. 49)

Starting from step 3 on p. 48.

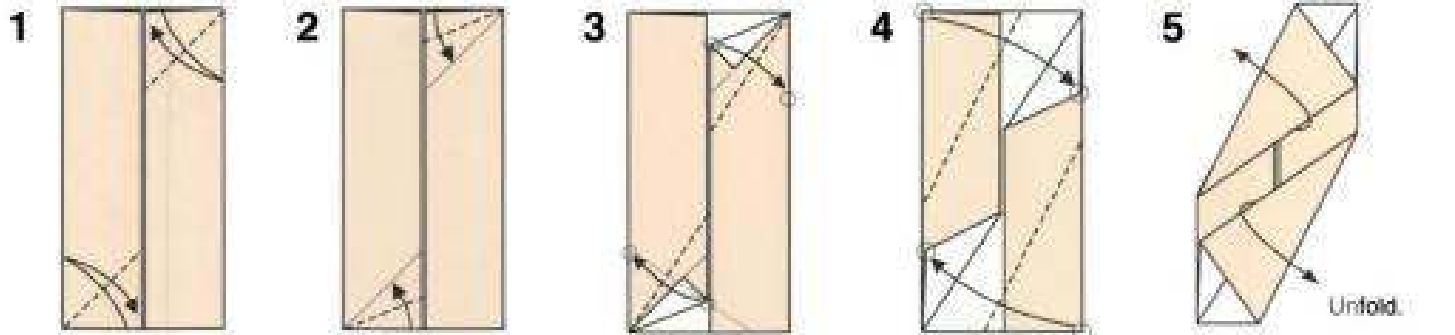

Fold so as to join the two circles ○.

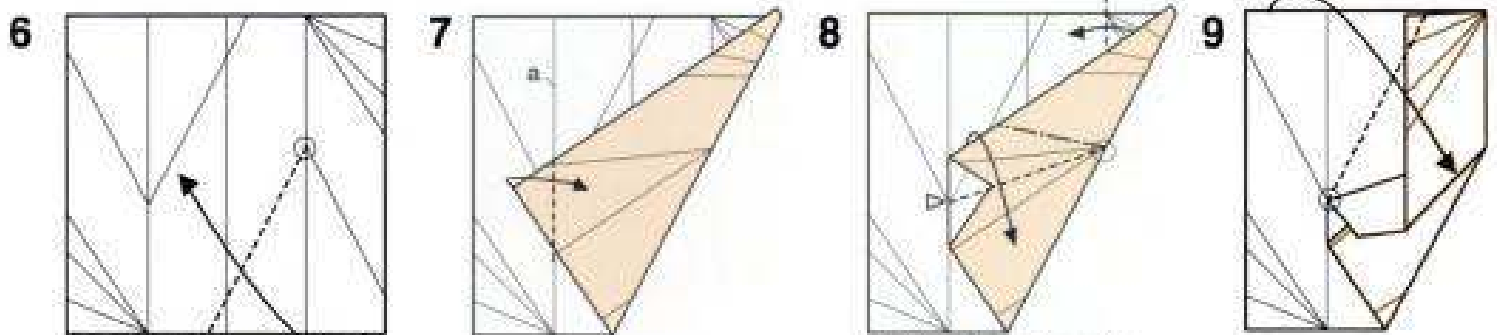

Fold to the place indicated by the circle ○.

Fold on line (a).

Fold on line between the triangle Δ and the circle ○.

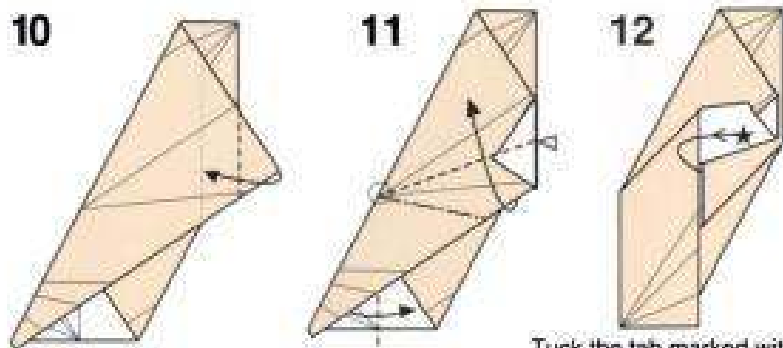

Tuck the tab marked with a star ★ inside the folds.

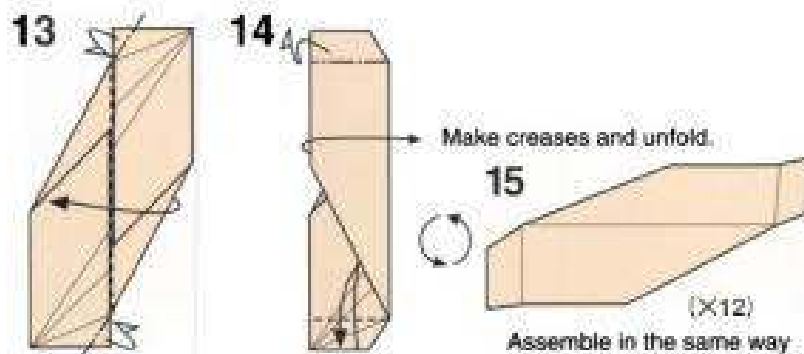

Make creases and unfold.

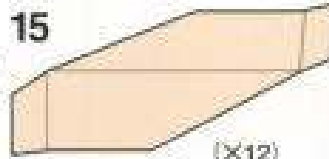

Assemble in the same way as the large cube (p. 49)

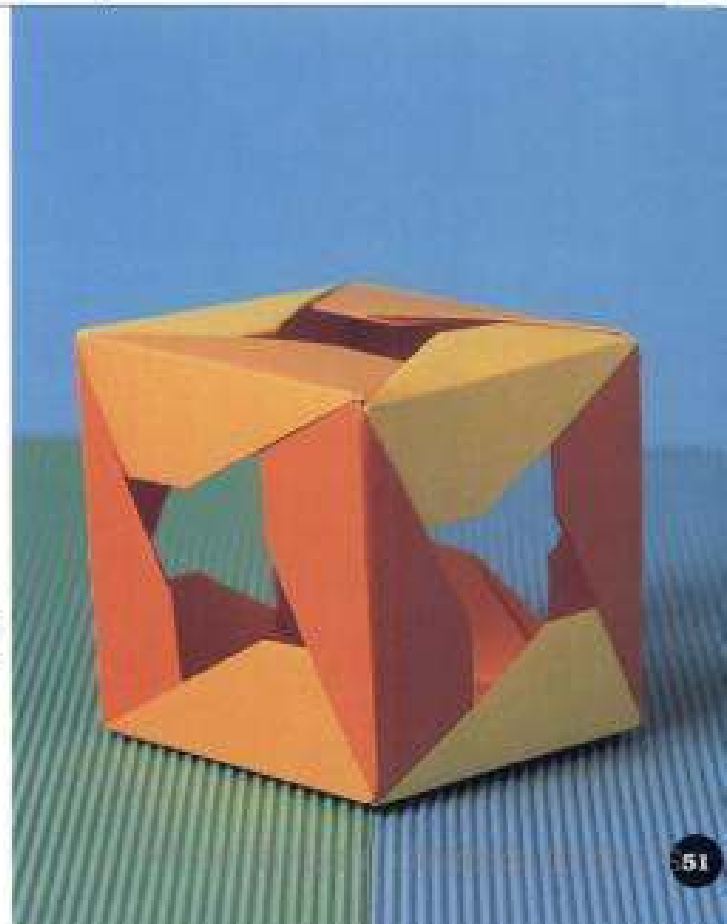

120-UNIT STRUCTURE /p.65

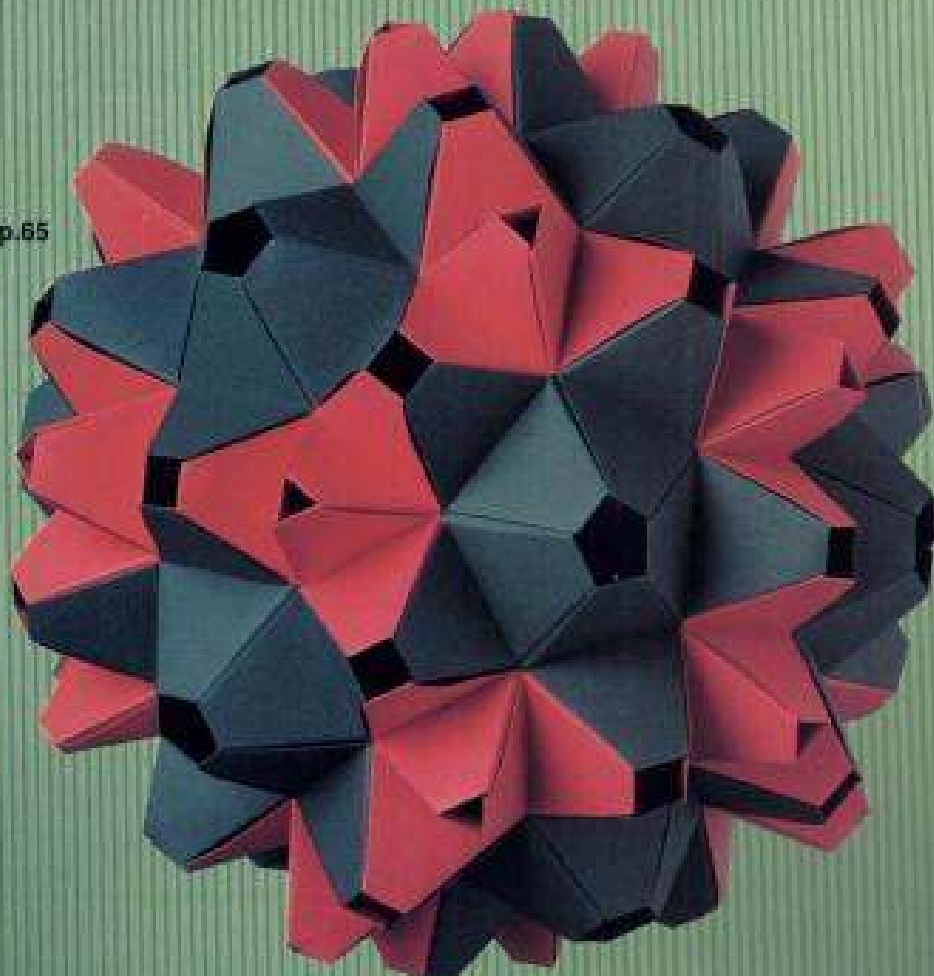

12-UNIT STRUCTURE /p.60

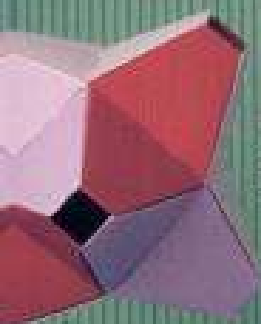

30-UNIT STRUCTURE /p.59



24-UNIT STRUCTURE /p.60

30-UNIT STRUCTURE /p.57

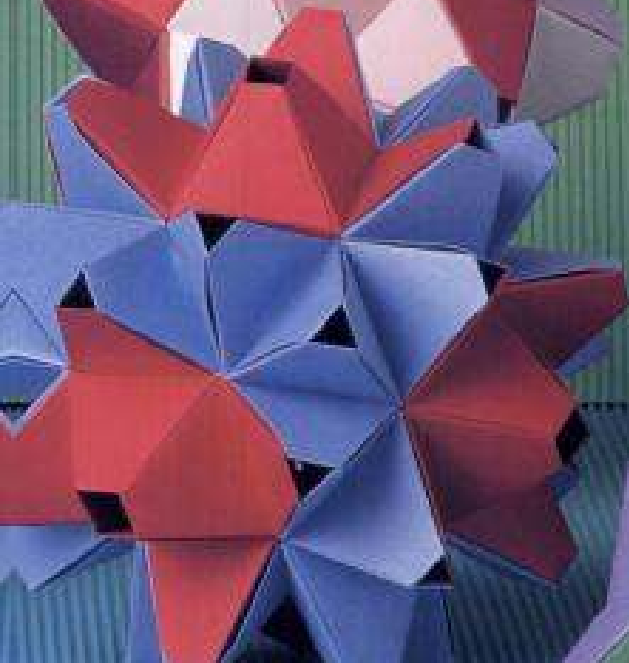

60-UNIT STRUCTURE /p.64

6-UNIT STRUCTURE /p.56

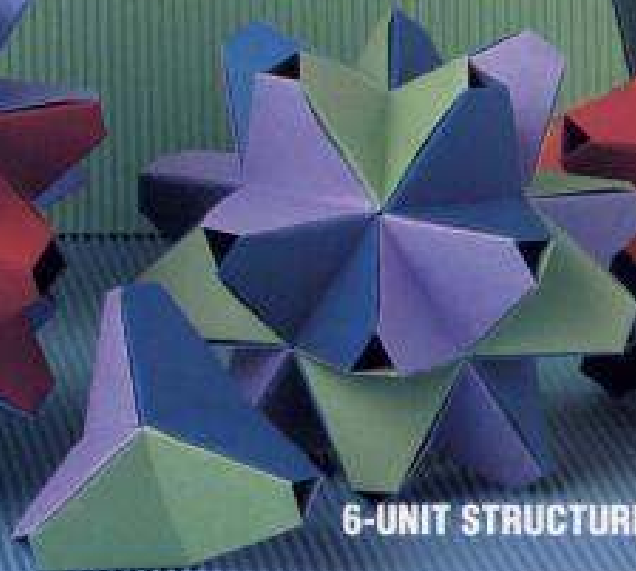

HINT ON ASSEMBLY 2

Regular Tetrahedron

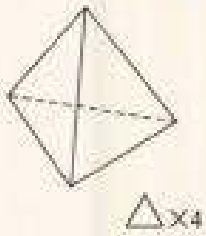

Cube

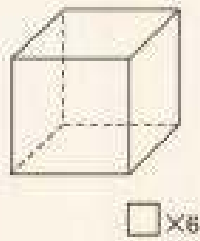

Cuboctahedron

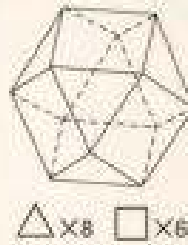

The bottom of each pyramidal unit has a different shape as shown below. You can use them to assemble various kinds of solids. Let's look at a regular tetrahedron, for example. The regular tetrahedron consists of 4 equilateral triangles. So you need to make a 3-unit structure, and put it together so that it has 4 triangular pyramids.

The next example is a cube consisting of 6 squares. So make a 4-unit structure, and put it together so that it has 6 square pyramids. When combining different shapes, begin with the smallest structure, although there may be cases in which you follow a different order. If you intend to make a cuboctahedron, begin with a 3-unit structure. Make it the core, and enlarge it by connecting the units one by one.

Assemble the 5-unit structure and the 6-unit structure in the same way.

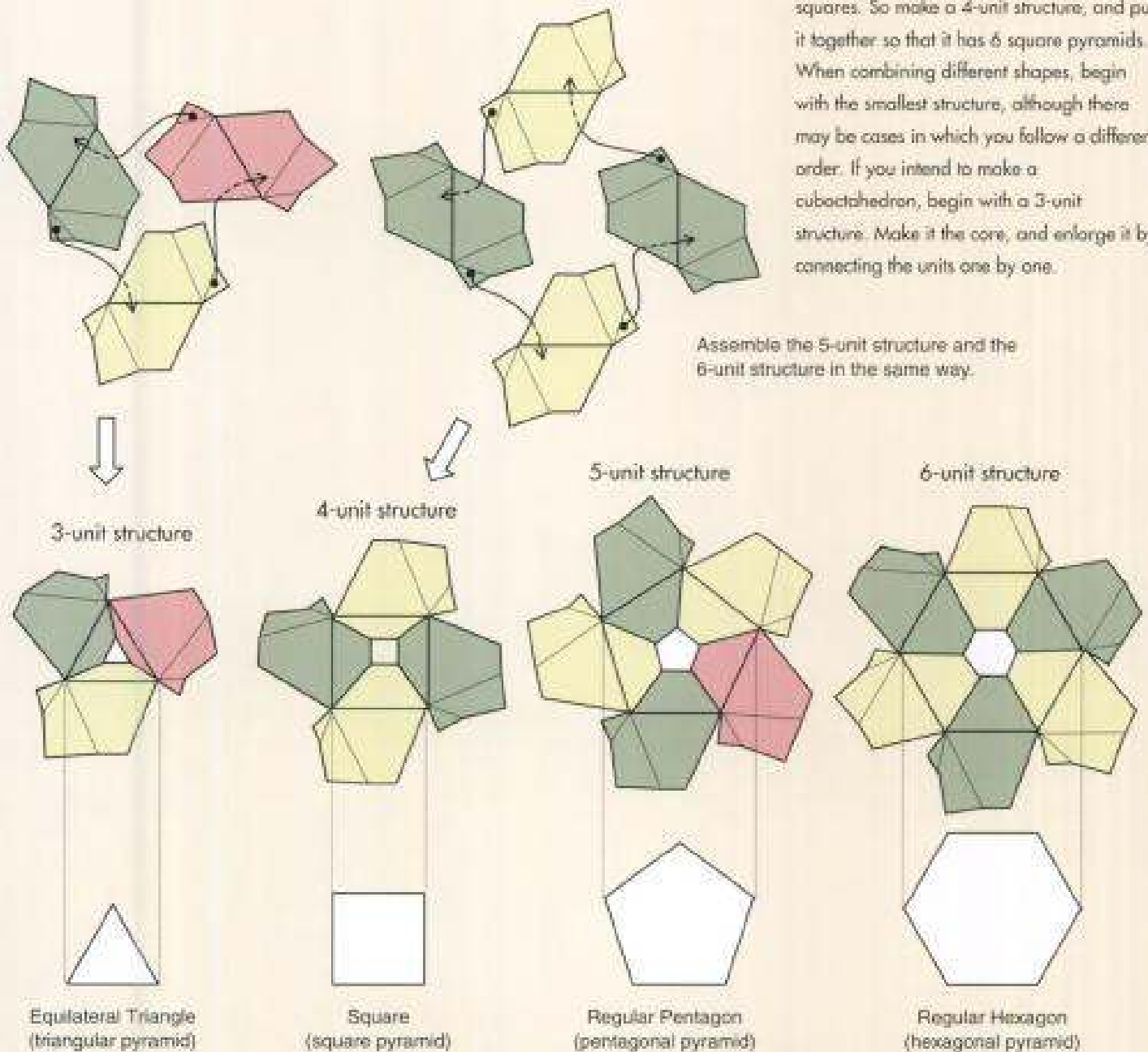

Double-sided convex hexagonal ring (p. 54)

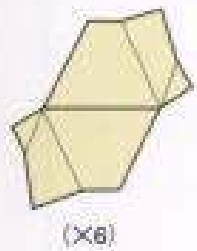

(×6)

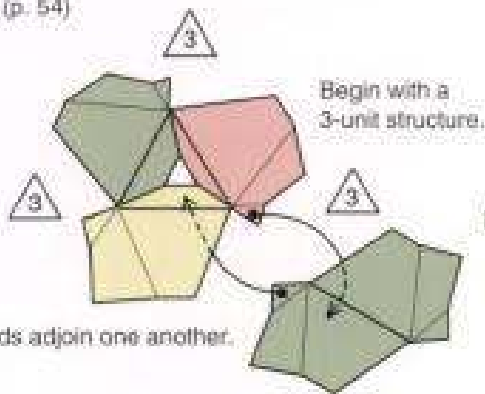

Begin with a 3-unit structure.

Triangular pyramids adjoin one another.

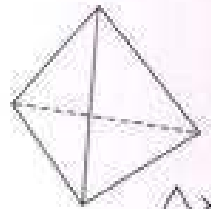
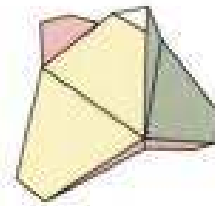

△×4

Double-sided convex hexagonal ring (p. 54)

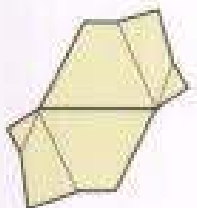

(×12)

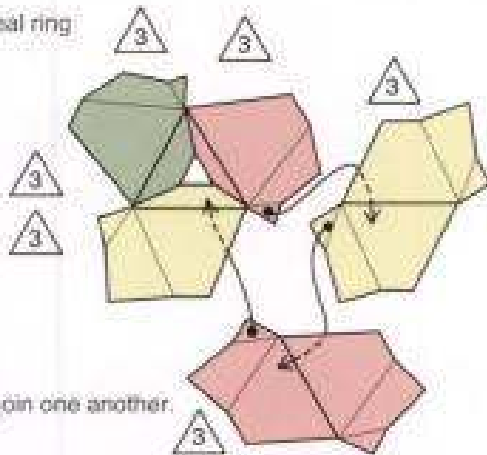

Four triangular pyramids join at the place marked by the star ☆.

Triangular pyramids adjoin one another.

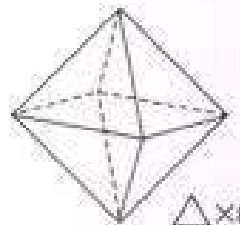
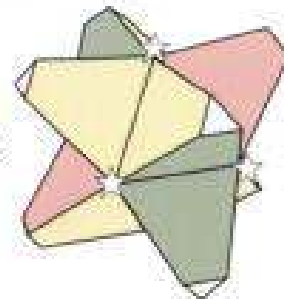

△×8

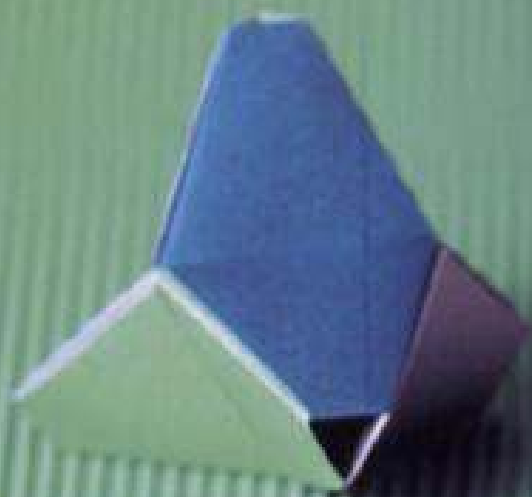

30-UNIT STRUCTURE *Regular Icosahedron*

level ★★

12cm × 6cm

Double-sided convex hexagonal ring (p. 54)

Five triangular pyramids join at the place marked with a star ☆.

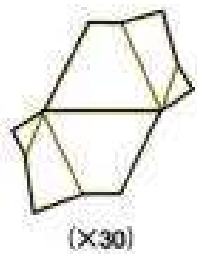

Make 5 triangular pyramids centered around the place marked with a star ☆.

Begin with a 3-unit structure.

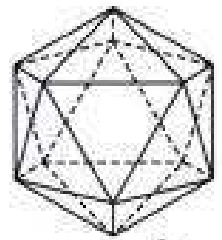
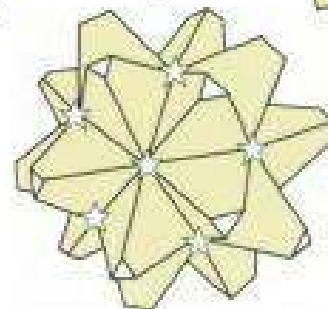
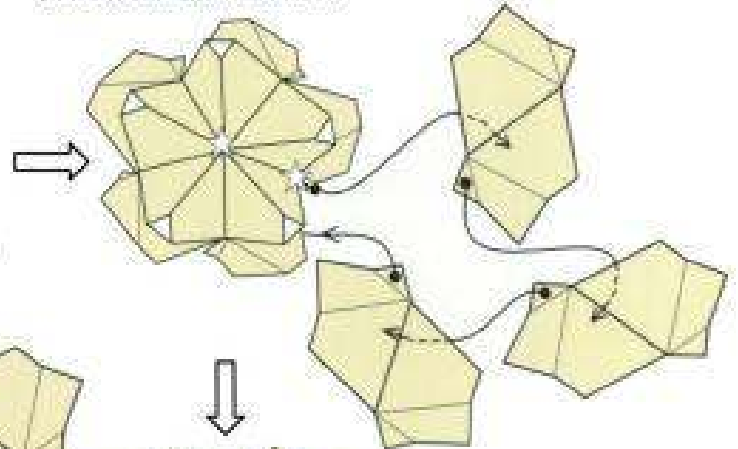
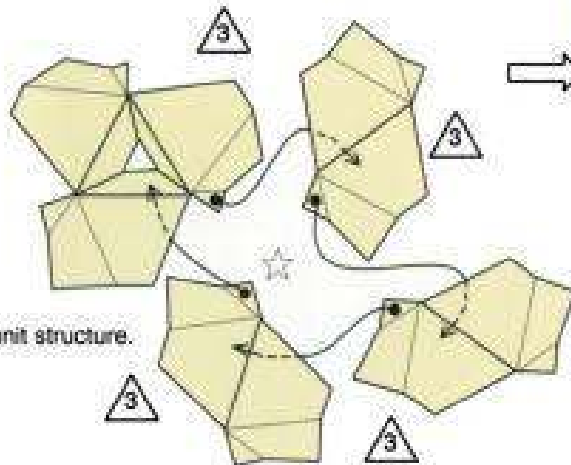

△ × 20

Five triangular pyramids join at the place marked with a star ☆.

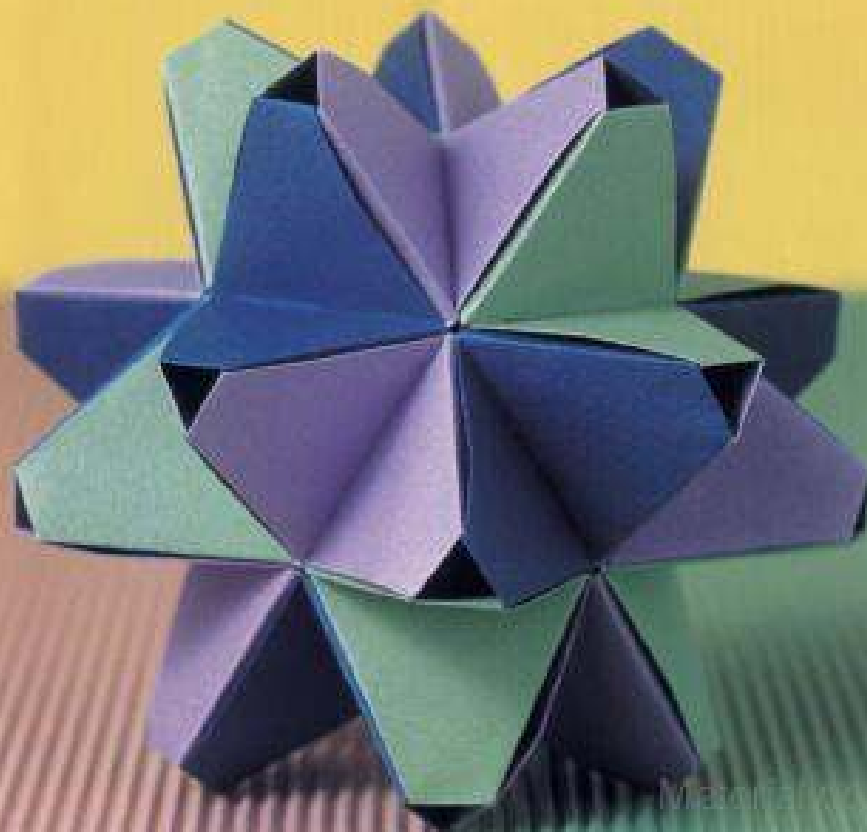

Double-sided mirror hexagonal ring (p. 54)

Begin with 4-unit structure.

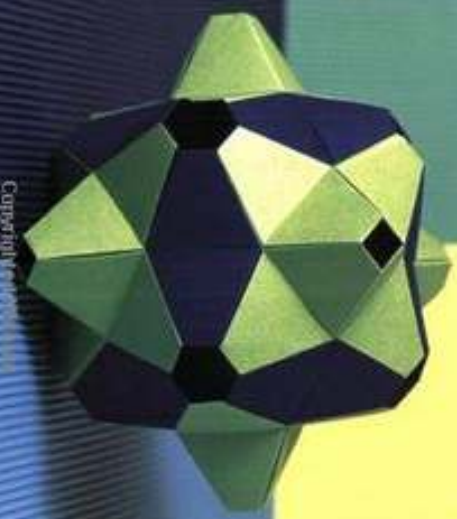
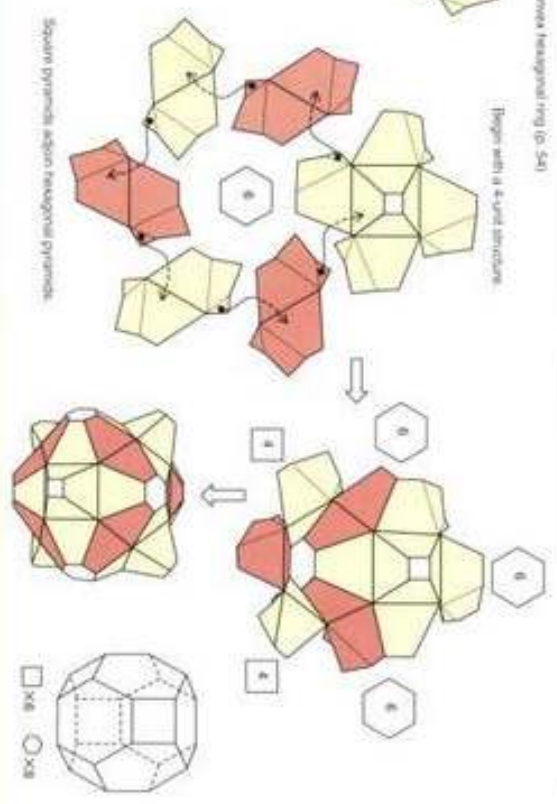
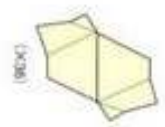

12-UNIT STRUCTURE Cube, 24-UNIT STRUCTURE Cuboctahedron

level ★

12cm × 6cm

Double-sided convex hexagonal ring (p. 54)

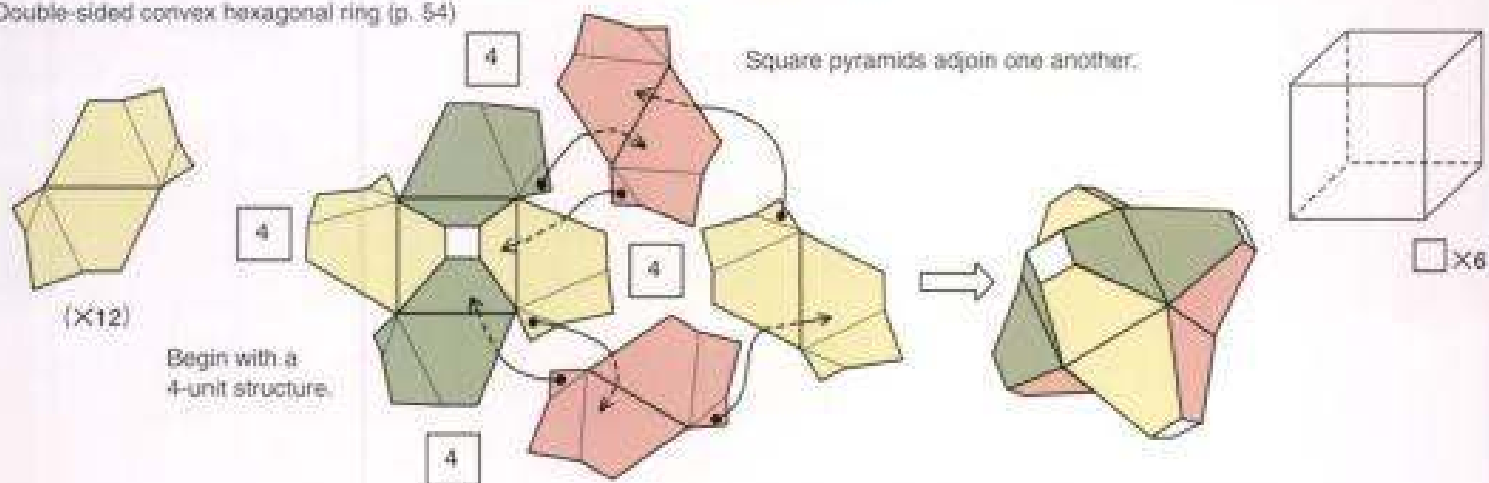

Double-sided convex hexagonal ring (p. 54)

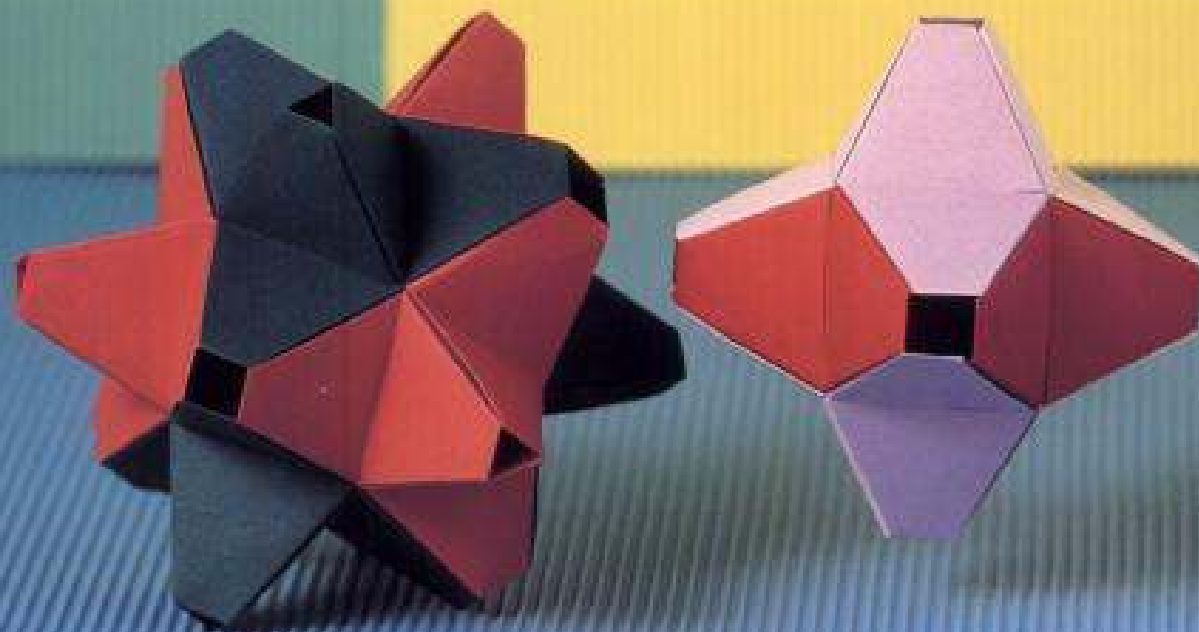
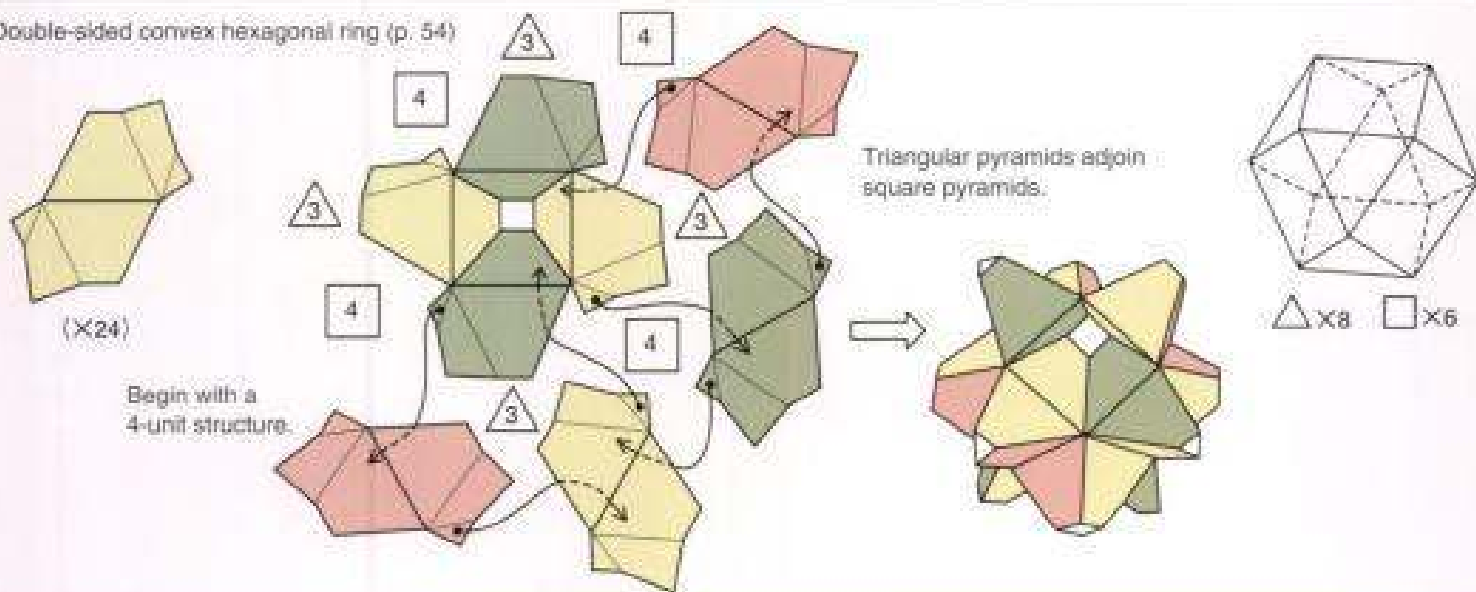

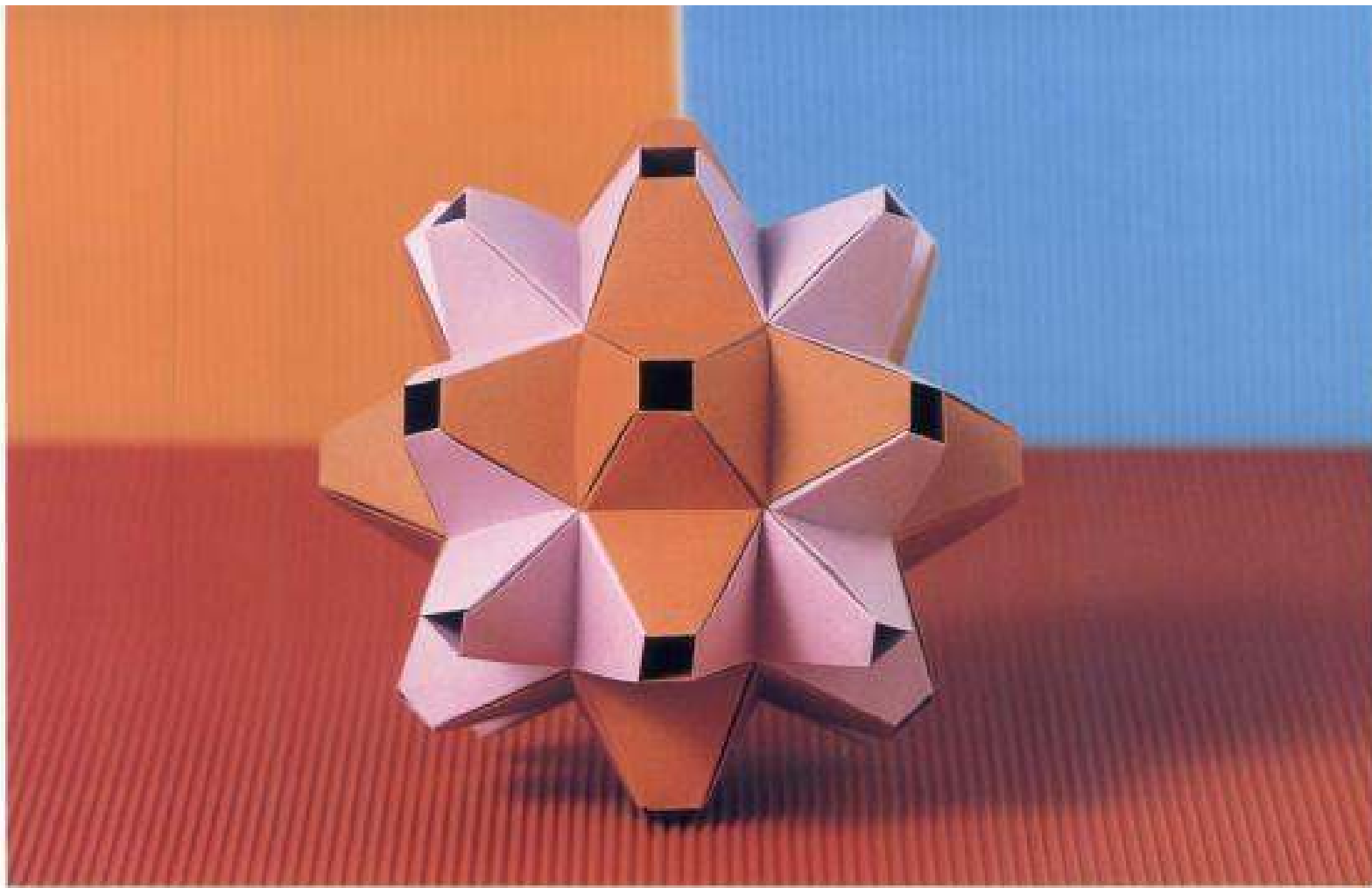

48-UNIT STRUCTURE Rhombic Cuboctahedron

level ★★

12cm × 6cm

Double-sided convex hexagonal ring (p. 54)

Begin with a 4-unit structure.

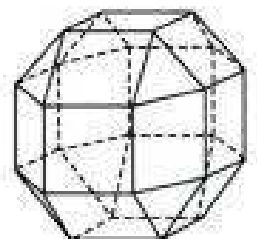
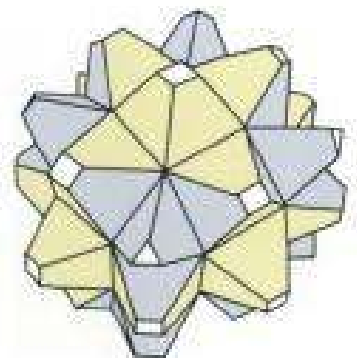
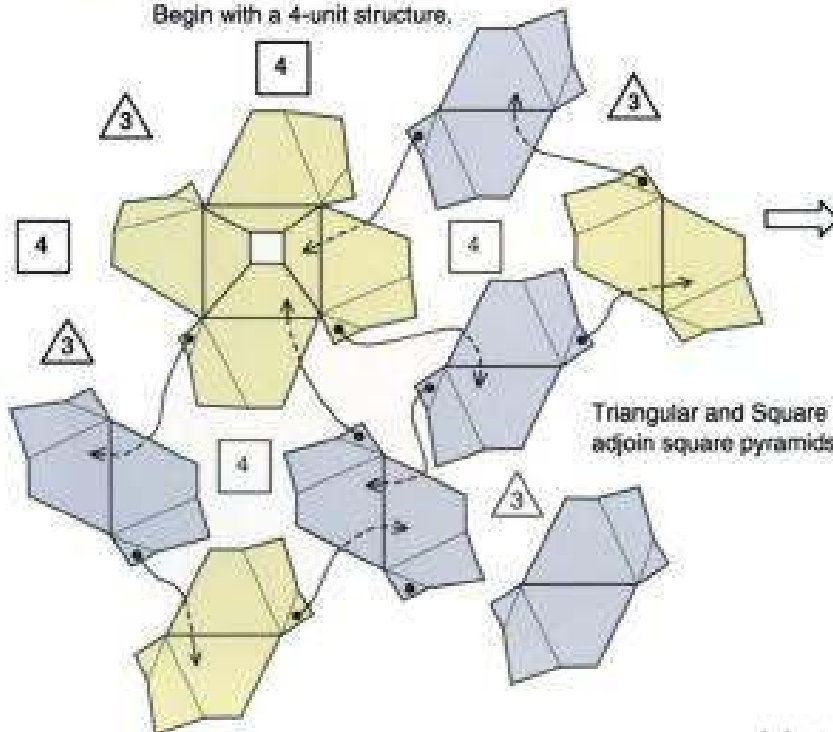
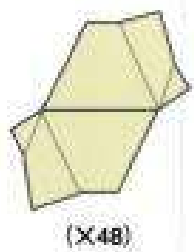

△ × 8 □ × 18

90-UNIT STRUCTURE Truncated Icosahedron

level ★★

12cm × 6cm

Double-sided convex hexagonal ring (p. 54)

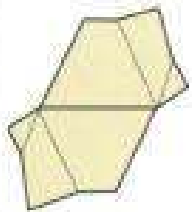

(x90)

Begin with a 5-unit structure.

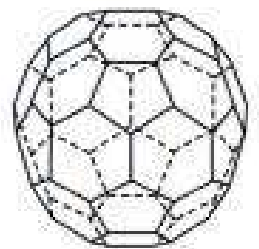
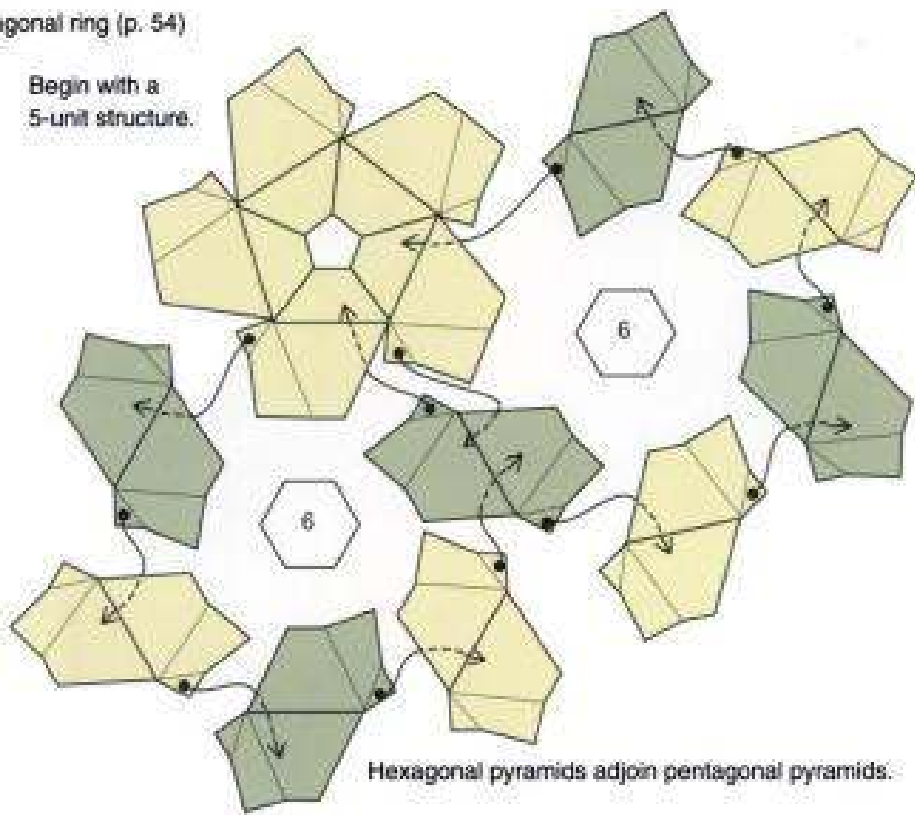

⬠ x12 ⬡ x20

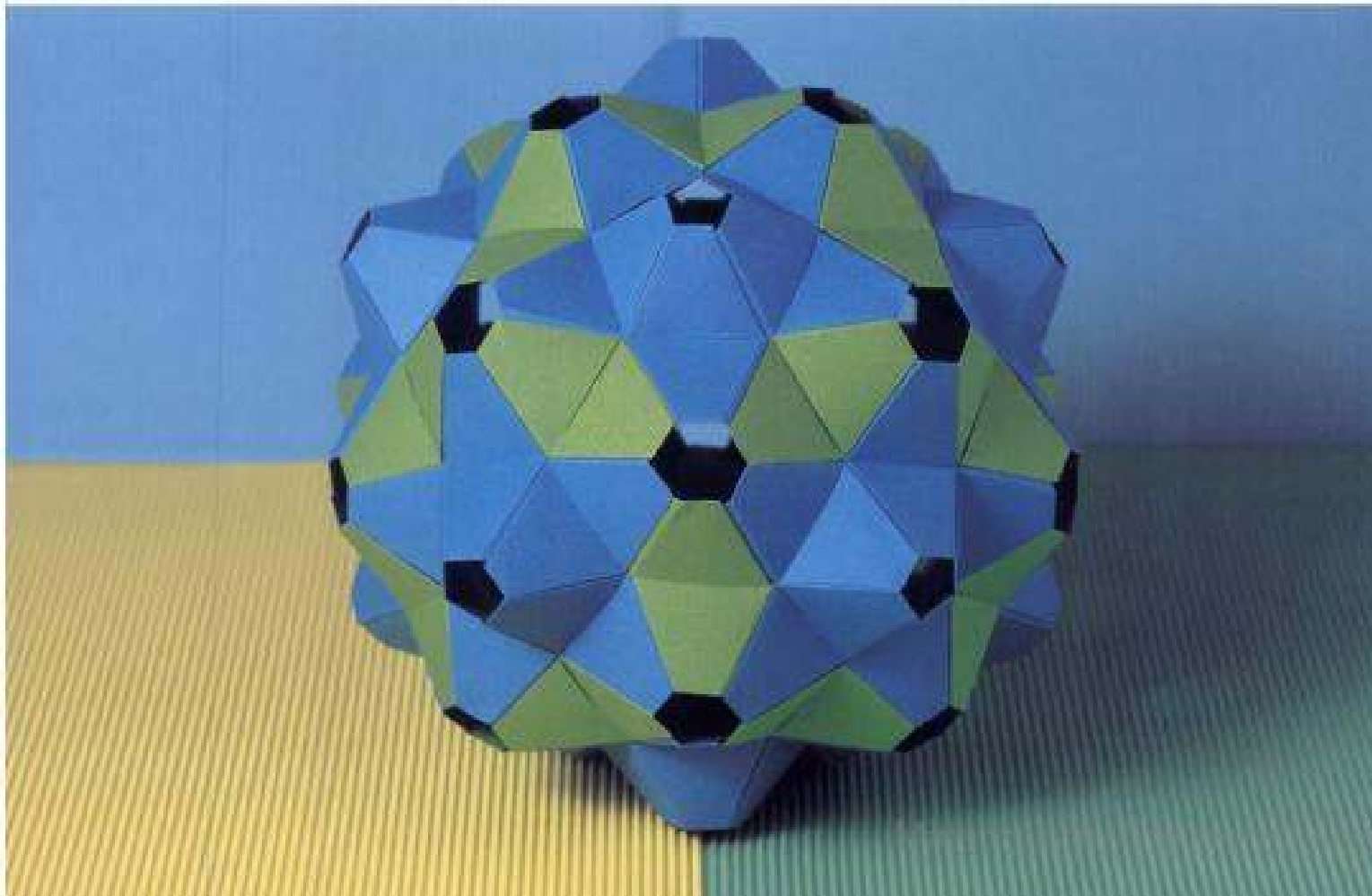

120-UNIT STRUCTURE Rhombic Icosahedron/Dodecahedron

level ★★★

12cm × 6cm

Double-sided convex hexagonal ring (p. 54)

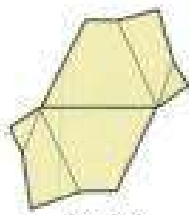

(×120)

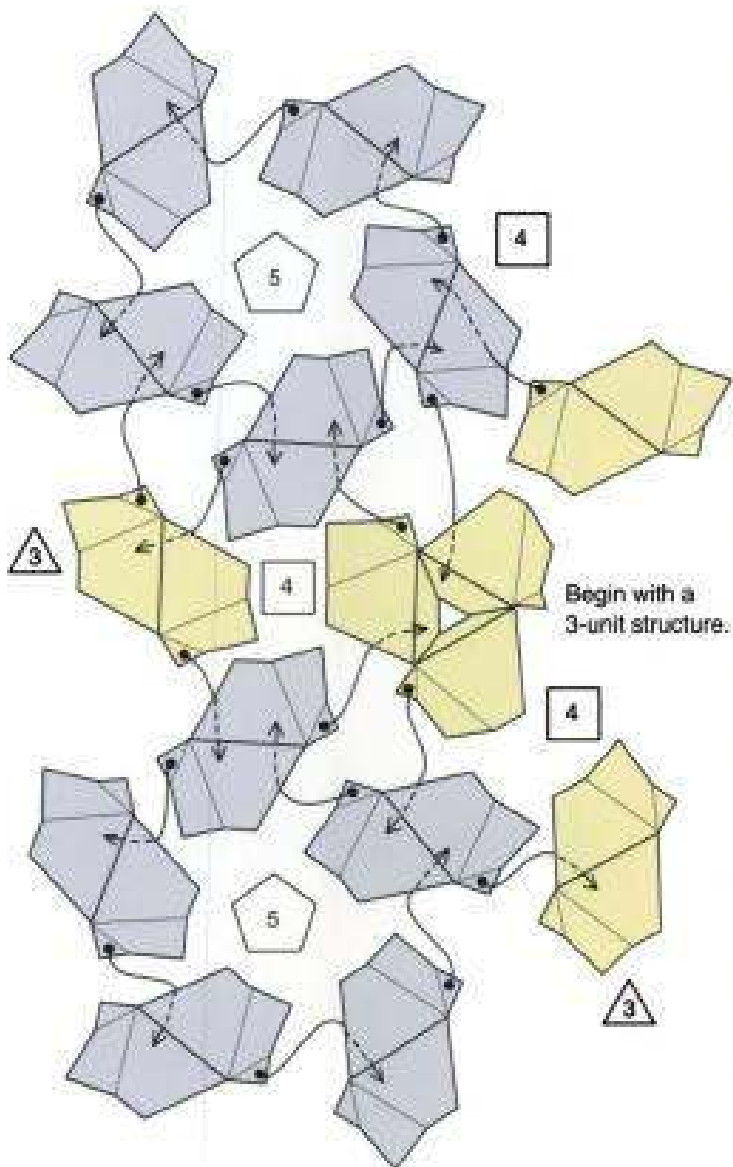

Begin with a 3-unit structure.

The sides that adjoin the pentagon are square.
The sides that adjoin the triangle are square.

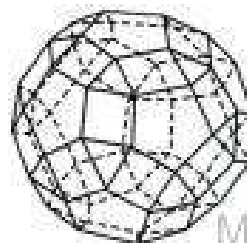
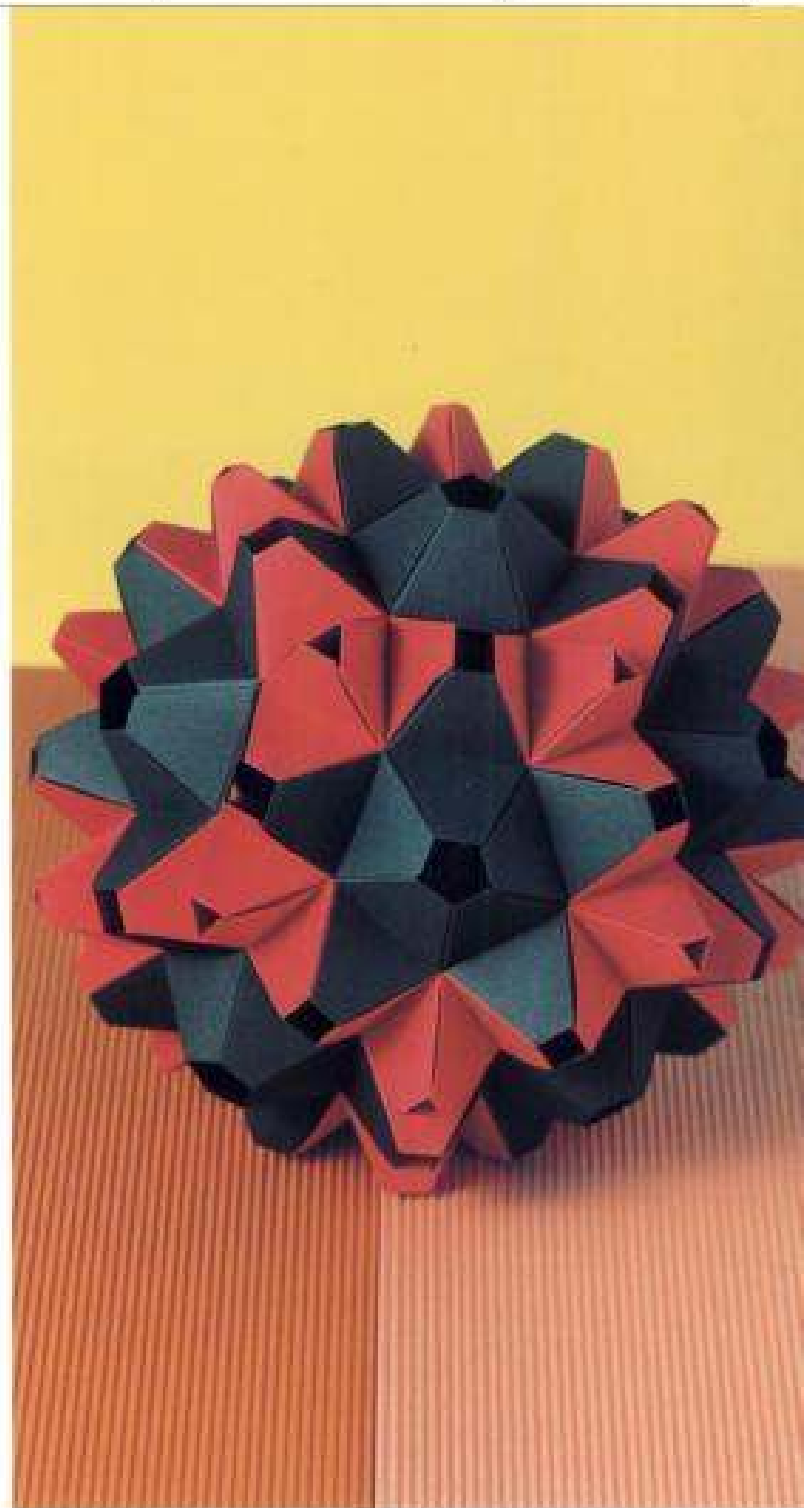

- △ ×20
- ×30
- ×12

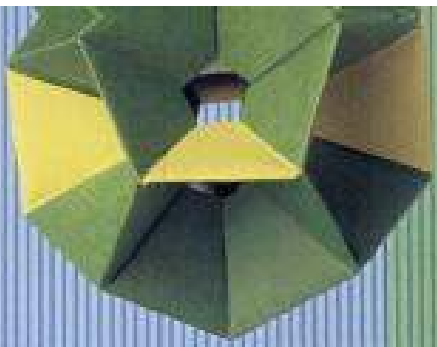

30-UNIT STRUCTURE /p.71

90-UNIT STRUCTURE /p.75

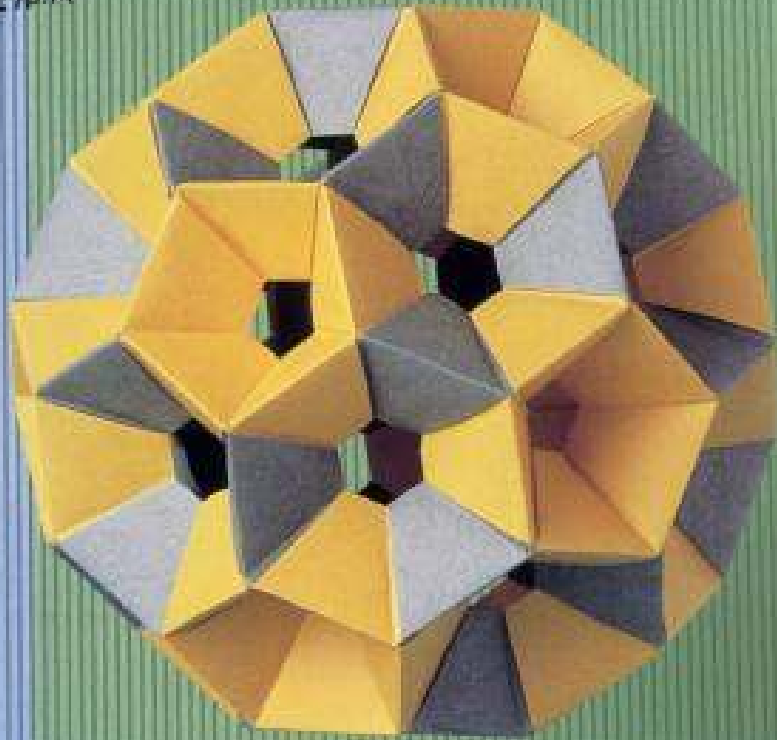

36-UNIT STRUCTURE /p.72

36-UNIT STRUCTURE /p.70

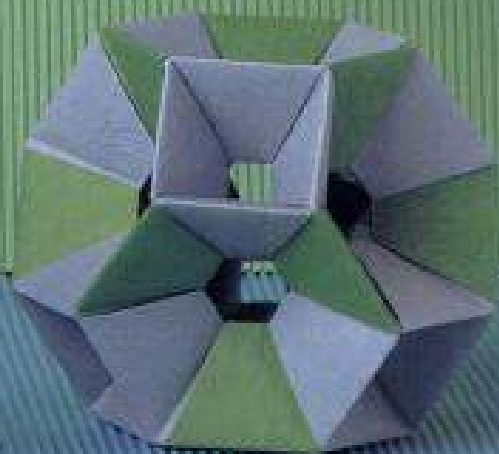

DOUBLE-SIDED CONCAVE HEXAGONAL RING SOLID

level ★ 12cm × 16cm

The structure is the same as that of the double-sided convex hexagonal ring solid. However, you use a different folding method when assembling it in order to hide the extra lines. The finished works are sturdy, so glue is not necessary. Unit B, which is used in some structures, has a crease only on one side.

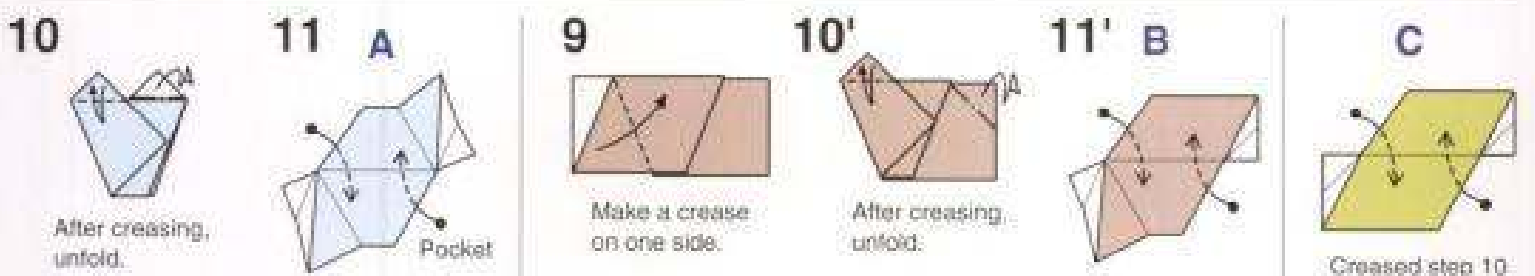
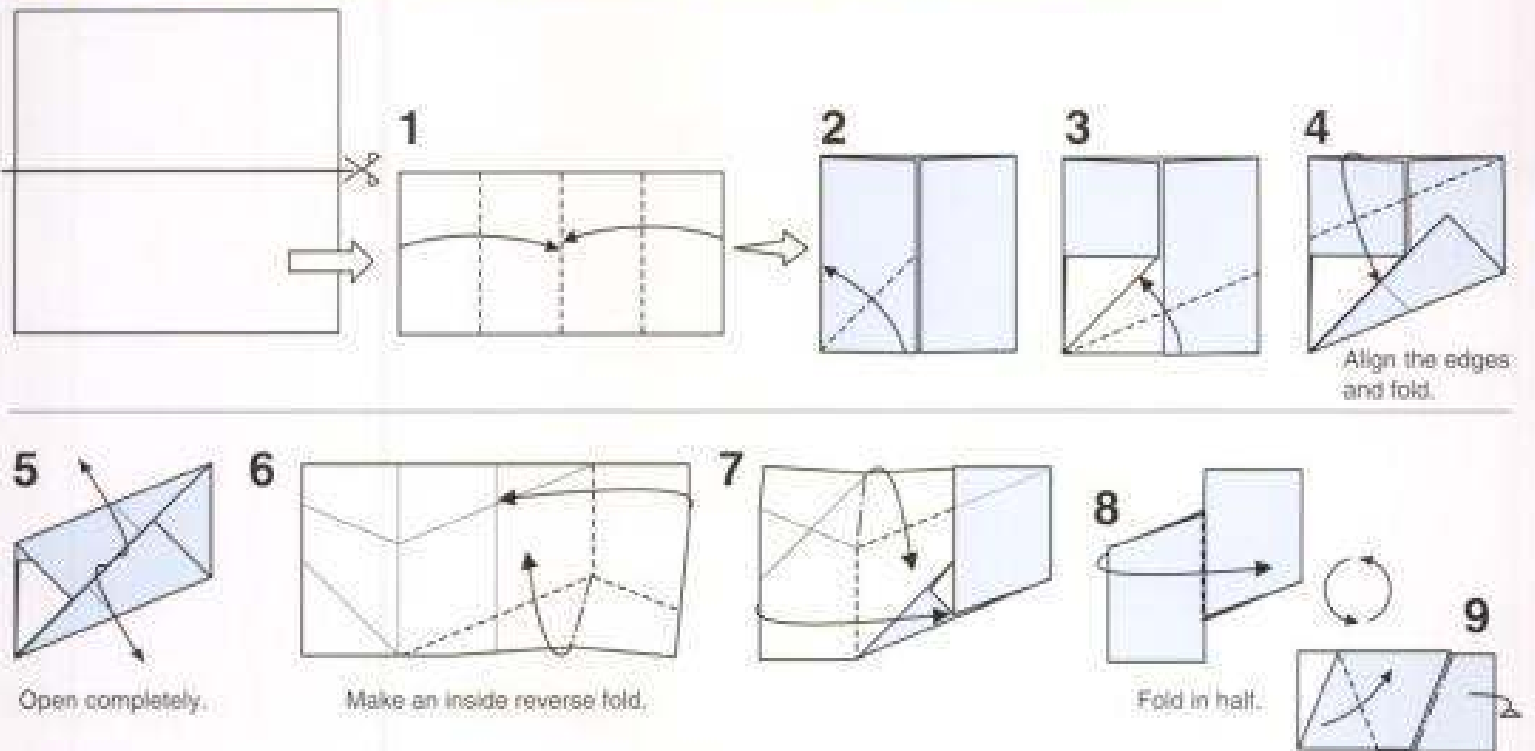

HINT ON ASSEMBLY 1

Take special note of the small triangle [shaded] in step 10. This triangle hooks firmly and makes the unit sturdy.

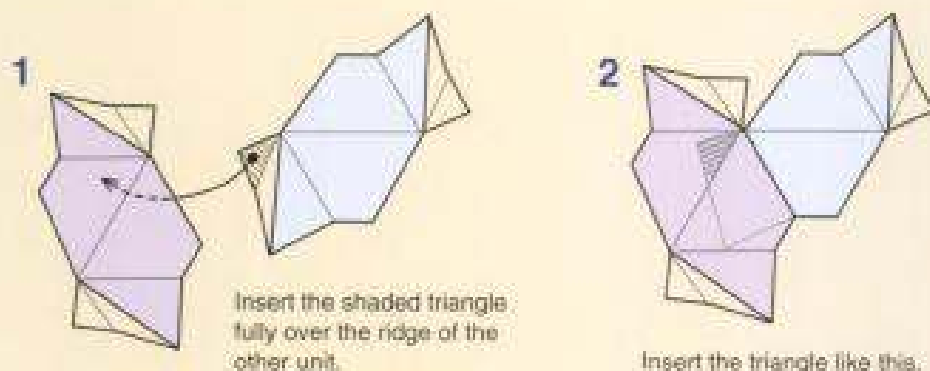

HINT ON ASSEMBLY 2

As is seen in the figures, the units are indented along the ridges. You can assemble various kinds of solids by making use of them. One example is a truncated octahedron. It consists of squares and hexagons.

First, make 4-unit structures and put them together so that the hexagons are connected adjoin around the square indentation. Begin with the smallest structure (a 4-unit structure in this case). Make it the core, and expand it by connecting additional units one by one.

Truncated Octahedron

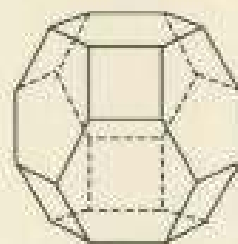

□ × 6
 ○ × 8

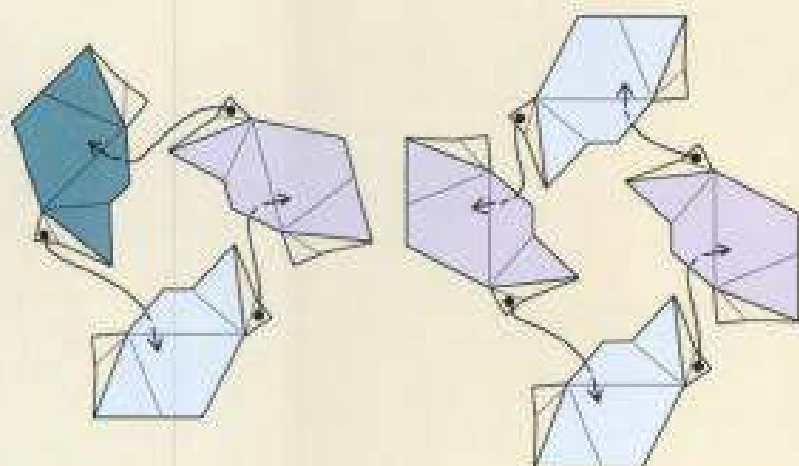

Assemble 5-unit and 6-unit structures in the same fashion.

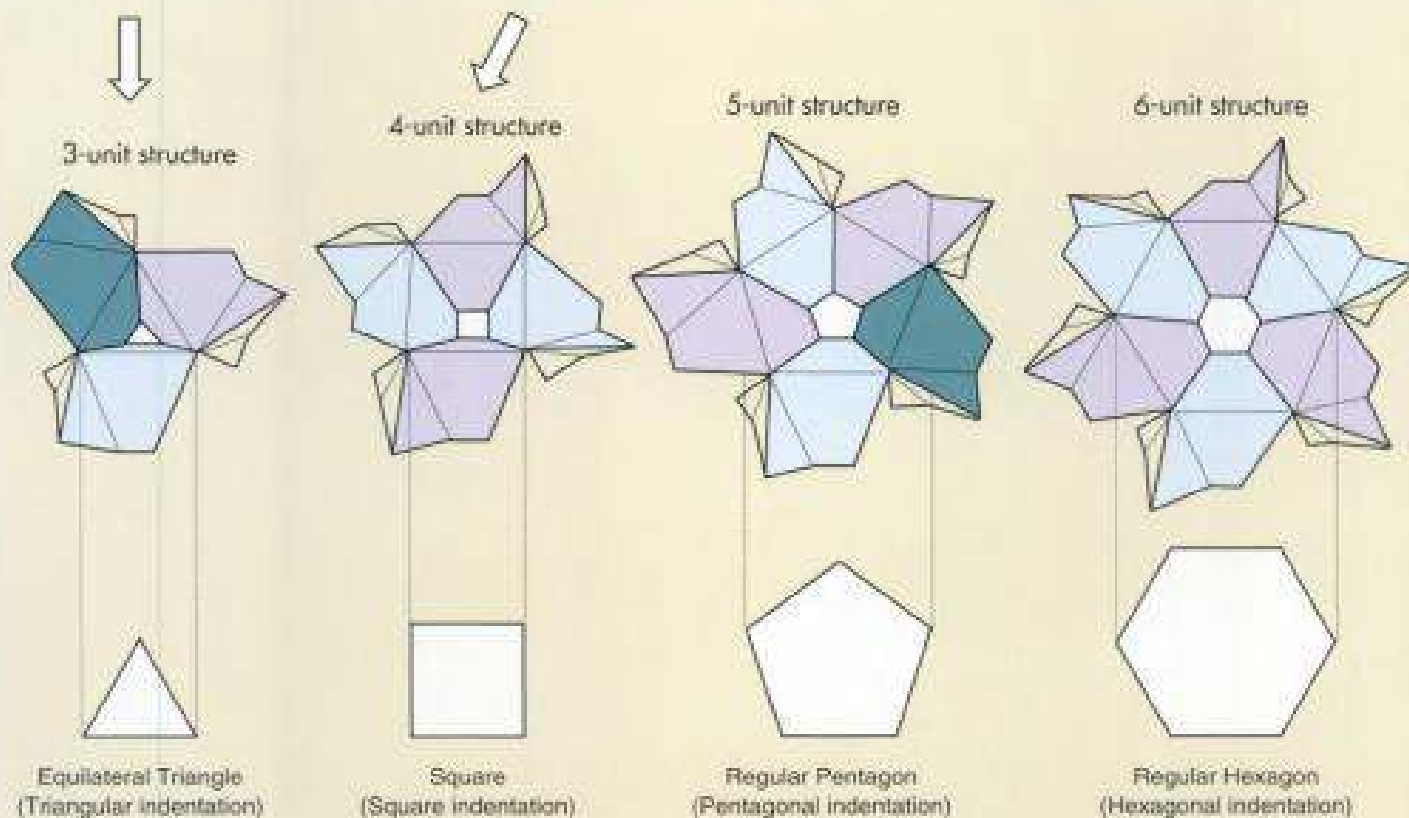

Double-sided concave hexagonal ring (p.66).

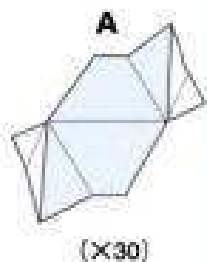

Begin with a 5-unit structure.

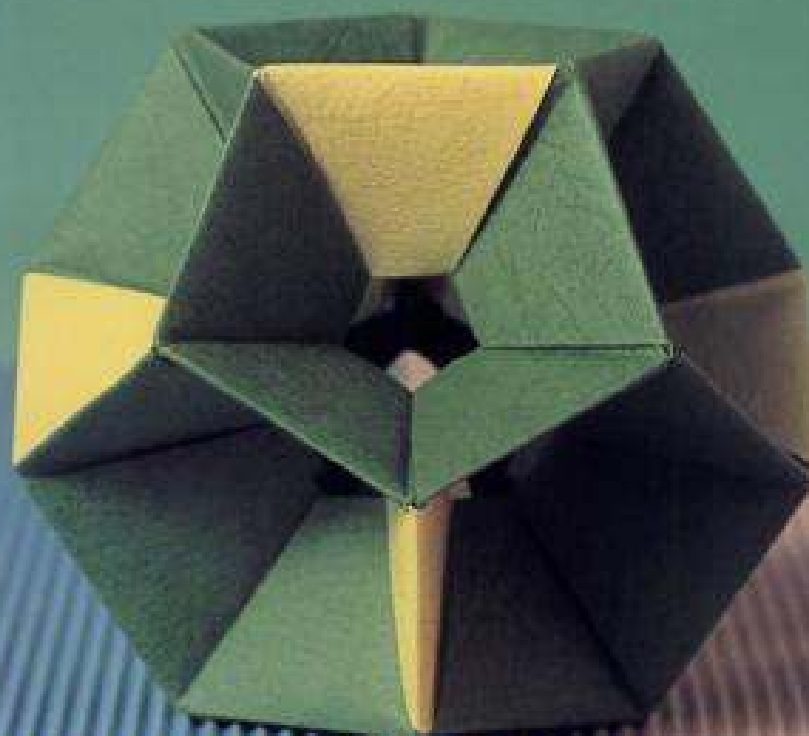
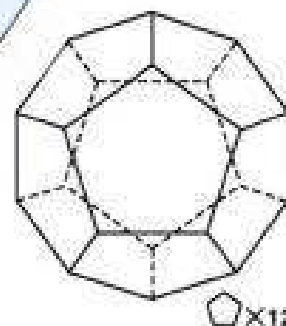
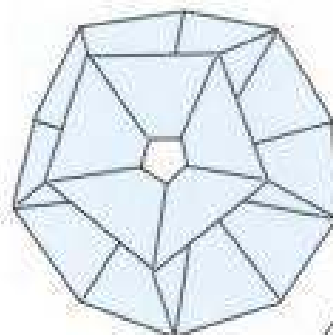
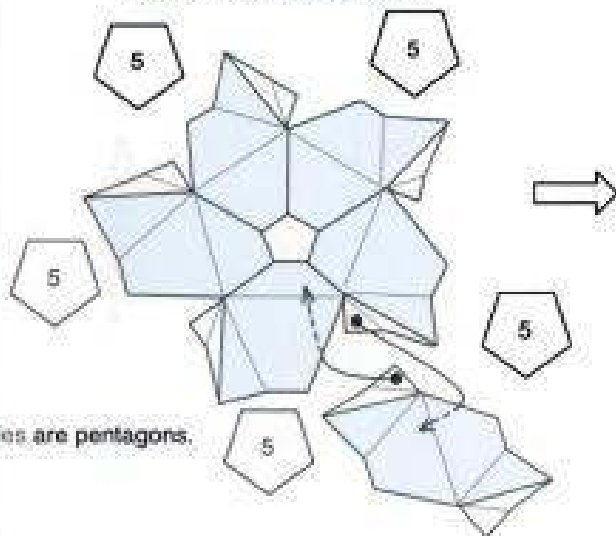

36-UNIT STRUCTURE Truncated Octahedron

level ★★

12cm × 6cm

Double-sided concave hexagonal ring (p.58)

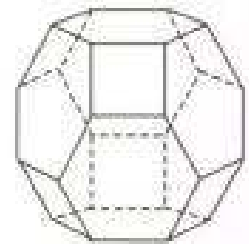
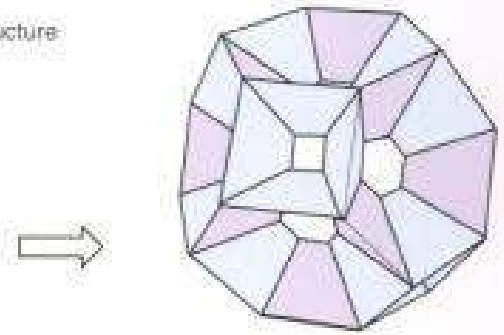
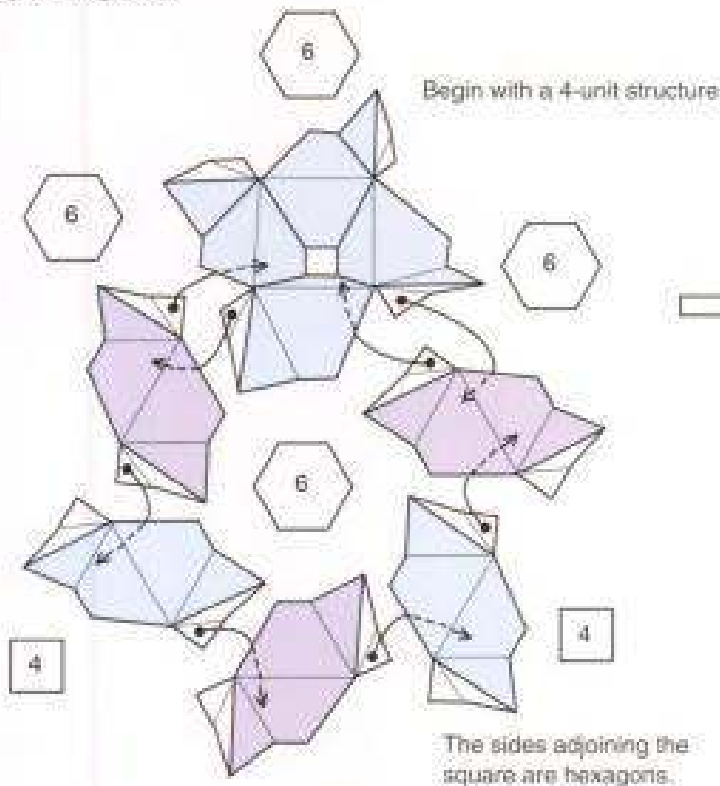

□ × 6 ○ × 8

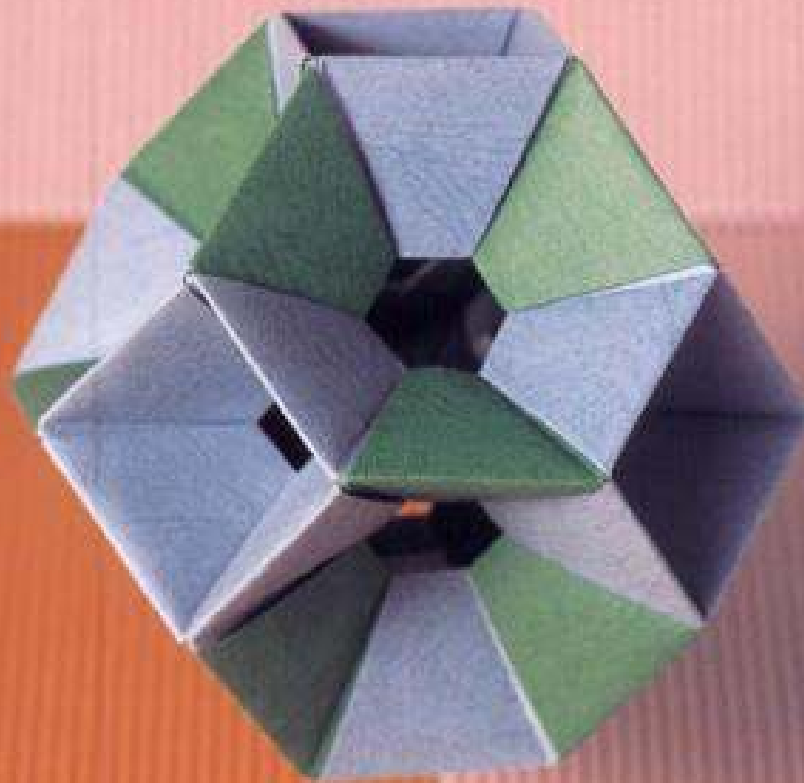

72-UNIT STRUCTURE Rhombic Truncated Octahedron

level ★★

12cm × 6cm

Double-sided concave hexagonal ring (p.68)

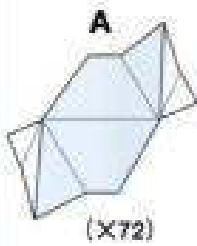

Begin with a 4-unit structure.

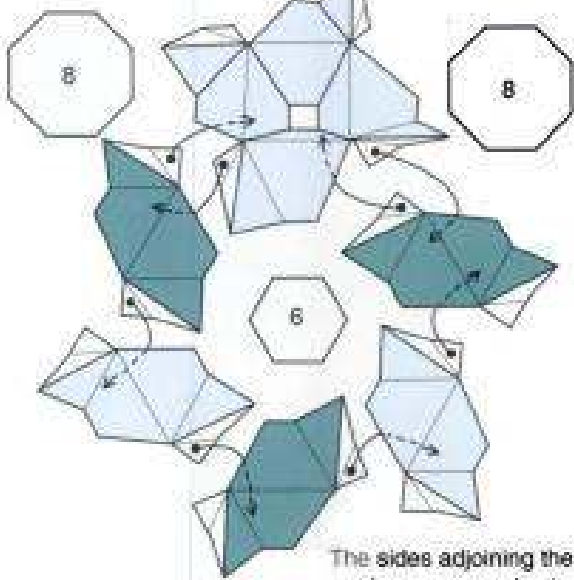

The sides adjoining the square are hexagons and octagons.

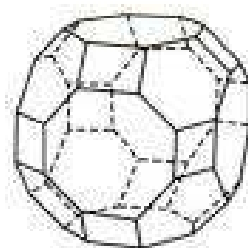
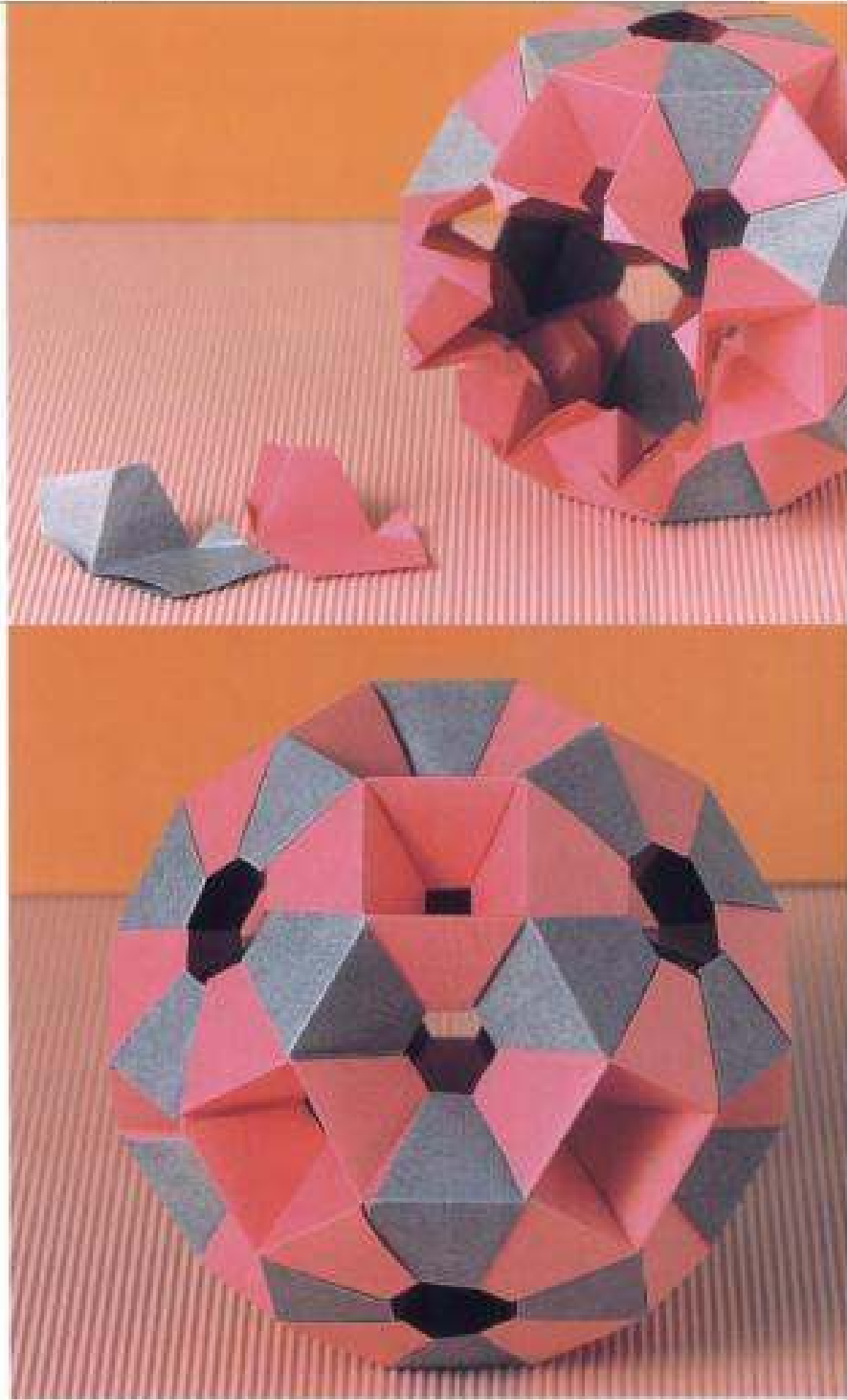
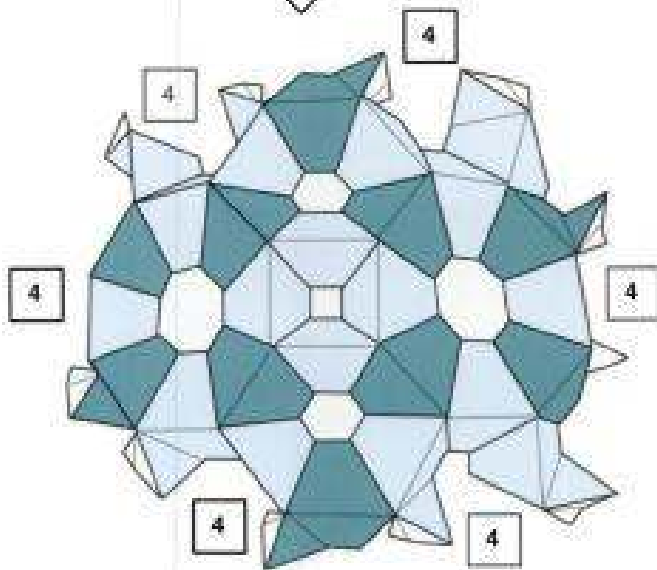

- x12
- x8
- x6

60-UNIT STRUCTURE Icosahedron/Dodecahedron

level ★★

12cm × 6cm

Double-sided concave hexagonal ring (p.68)



Begin with a 5-unit structure:

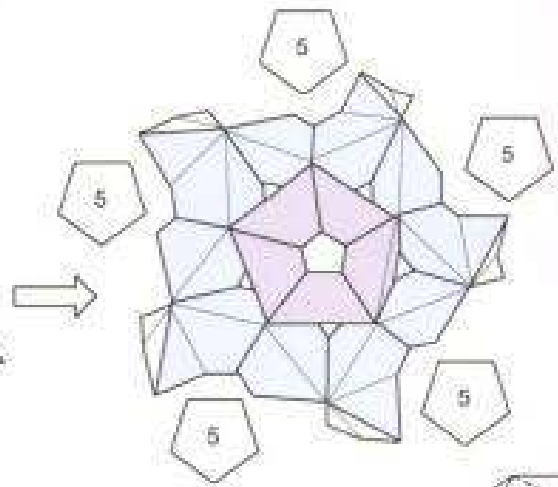
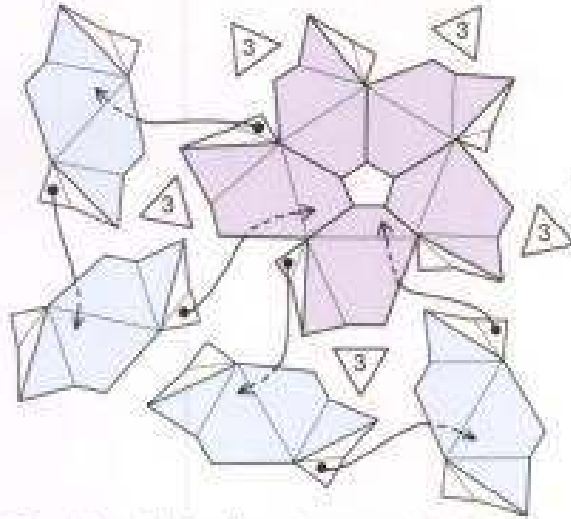

The sides adjoining the pentagon are triangles.

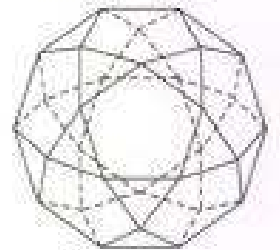

△x20 ○x12

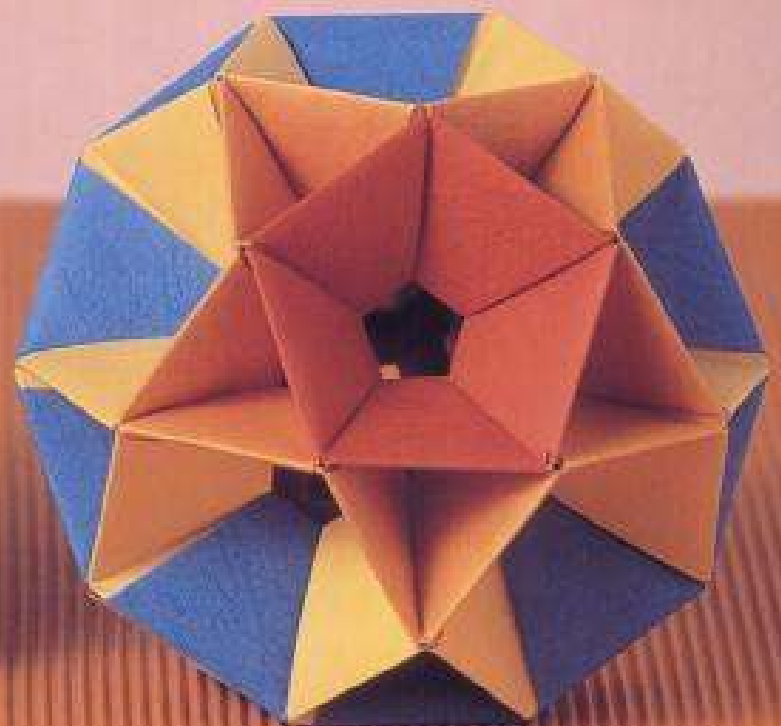
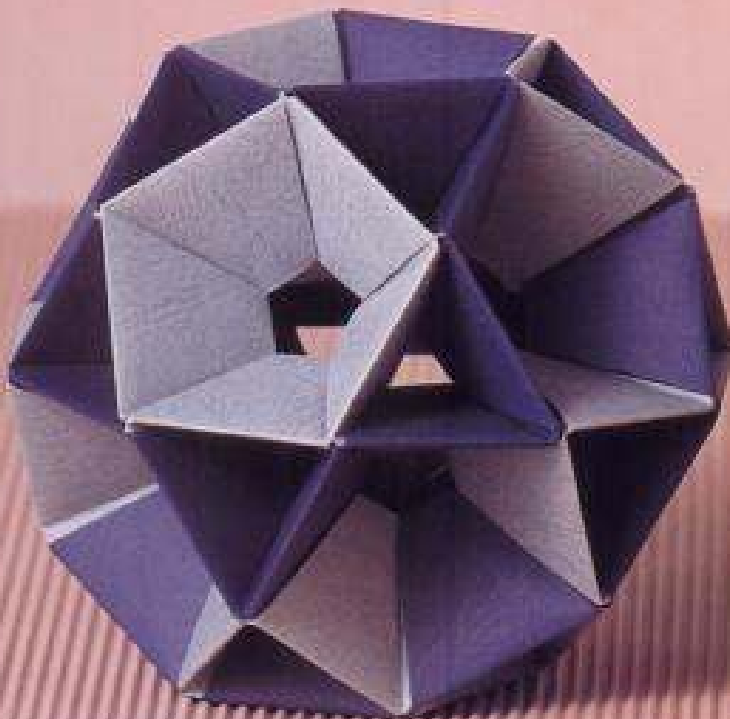

90-UNIT STRUCTURE *Truncated Icosahedron*

level ★★

12cm × 6cm

Double-sided concave hexagonal ring (p.68)

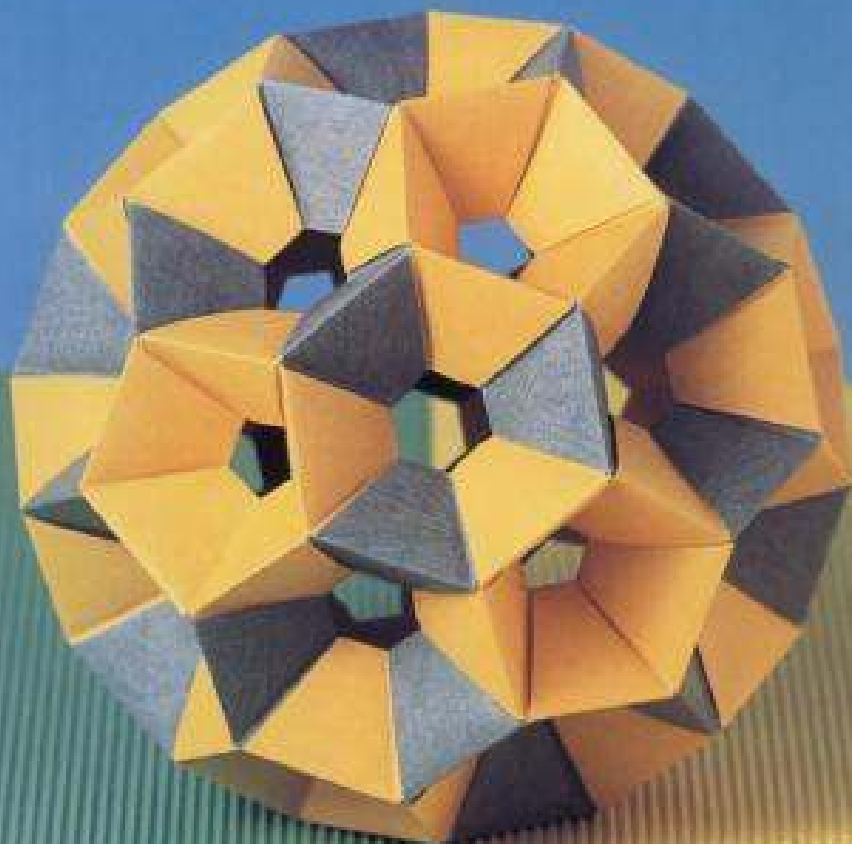
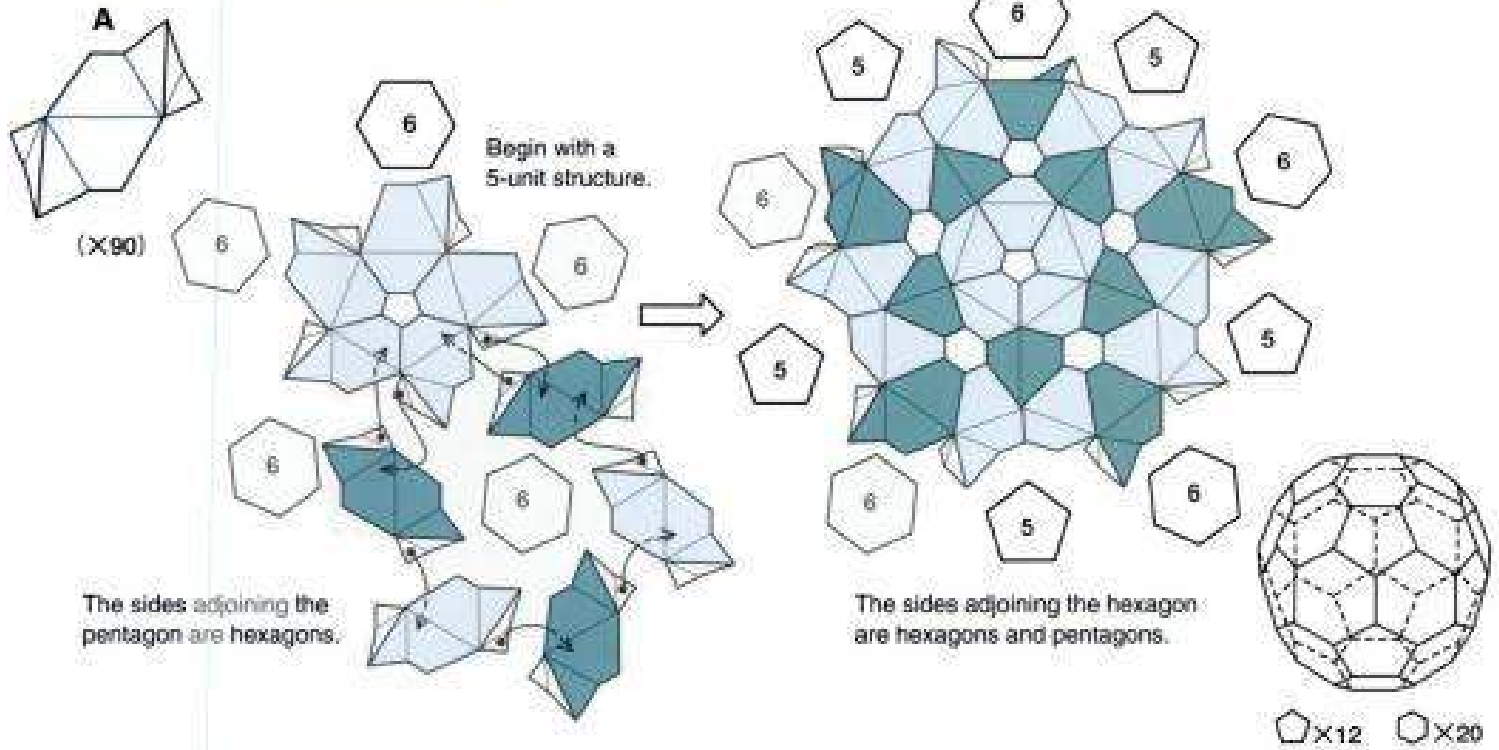

Double-sided concave hexagonal ring (p.68)

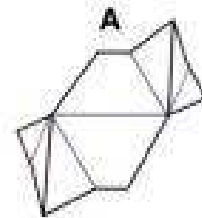

(×120)

The sides adjoining the pentagon are squares.
The sides adjoining the triangle are squares.

Begin with a 5-unit structure.

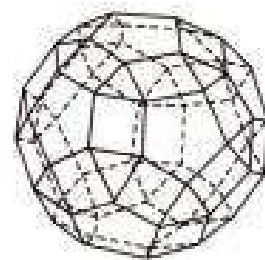
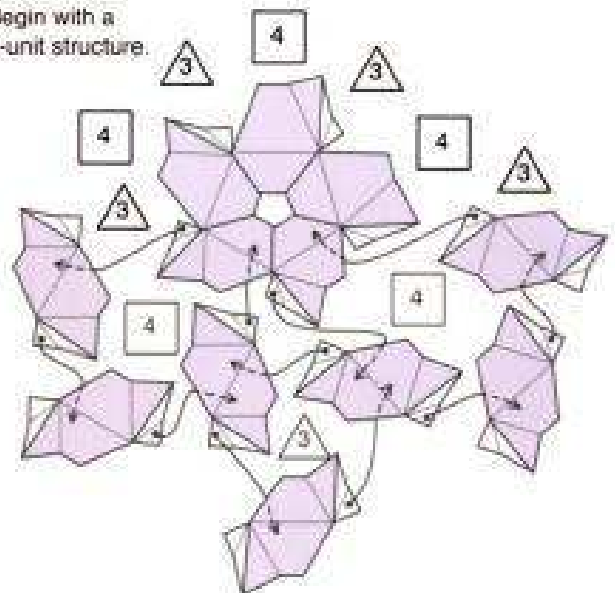

△ × 20 □ × 30 ◻ × 12

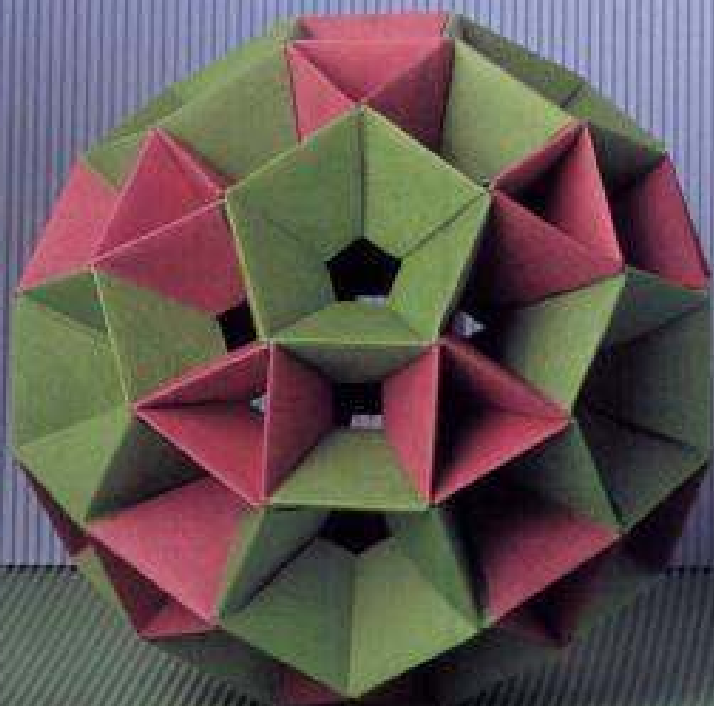

Double-sided Hexagonal Rings FROM DIFFERENT SIZES OF PAPER

level ★

It is possible to fold double-sided convex and concave units from A4 (210 x 297 mm) or B5 (182 x 257 mm) paper. In that case, you end up with larger windows.

If you fold using square paper, the windows end up being too large and make the unit fragile.

A4 (210 x 297 mm) or
B5 (182 x 257 mm)

CONVEX TYPE

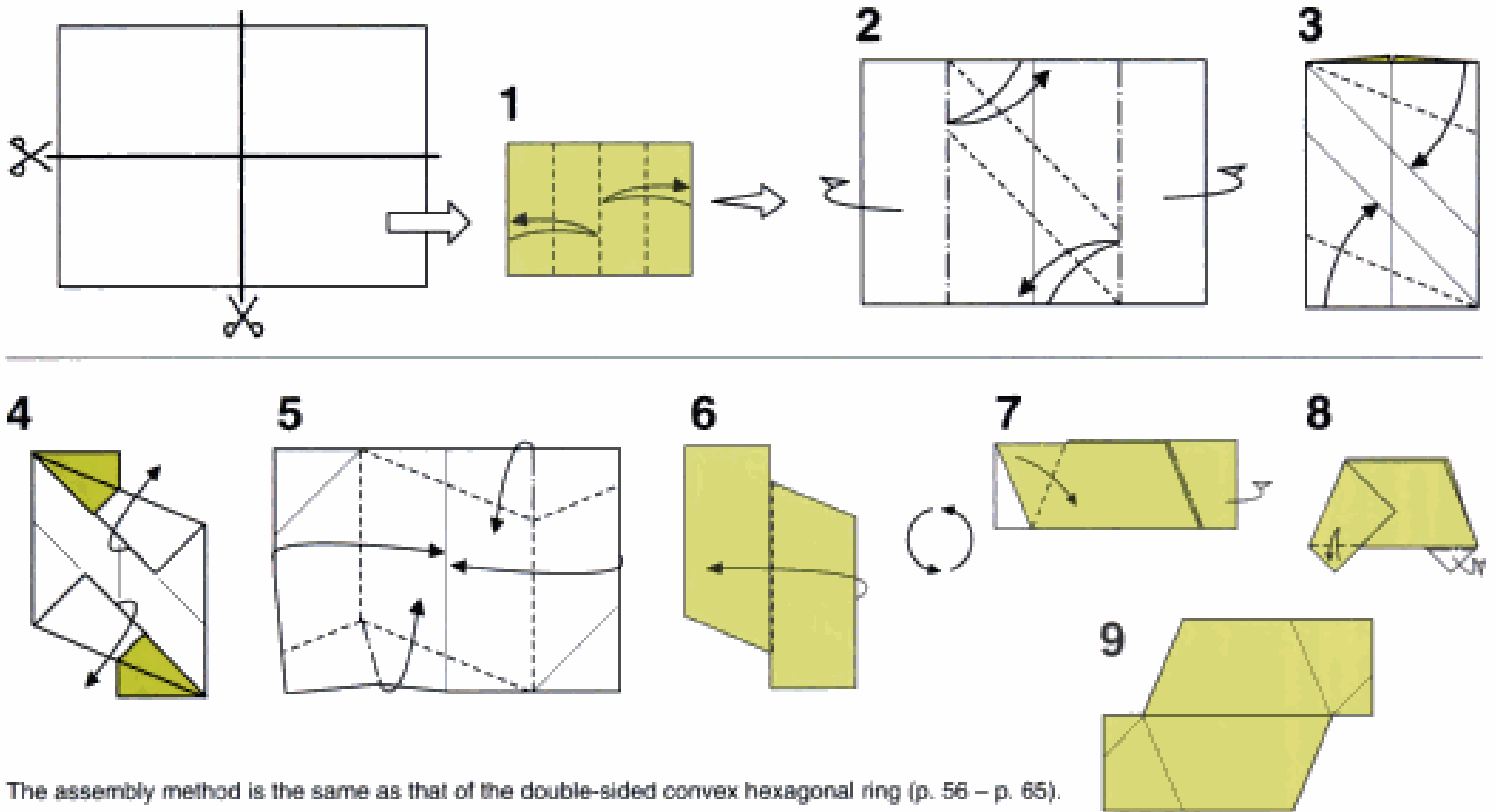

CONCAVE TYPE

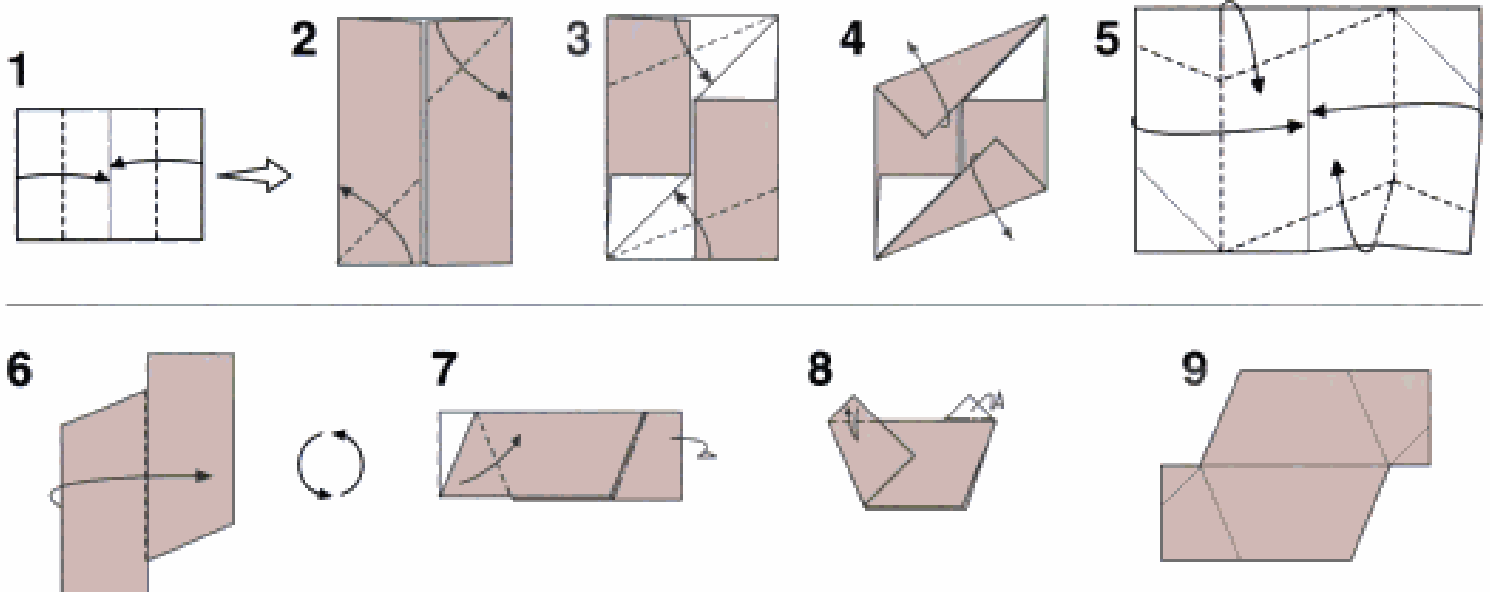

75-UNIT STRUCTURE /p.84



68-UNIT STRUCTURE /p.88



68-UNIT STRUCTURE /p.82



90-UNIT STRUCTURE /p.85

40-UNIT STRUCTURE /p.82



36-UNIT STRUCTURE /p.80



28-UNIT STRUCTURE /p.83



Double-sided convex
hexagonal ring (p. 54)

You can assemble the double-sided hexagonal ring in shapes other than a ball.
See how many kinds of structures you can assemble using convex units.



[Framework Shape]

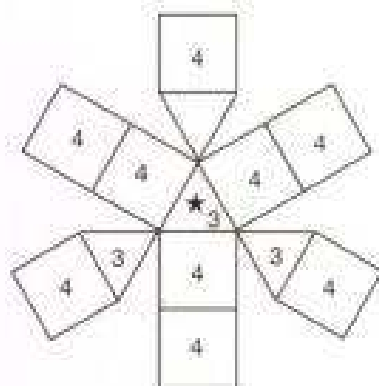
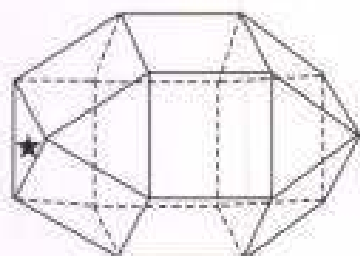

The framework shape viewed lengthwise.
(Intermediate stage)

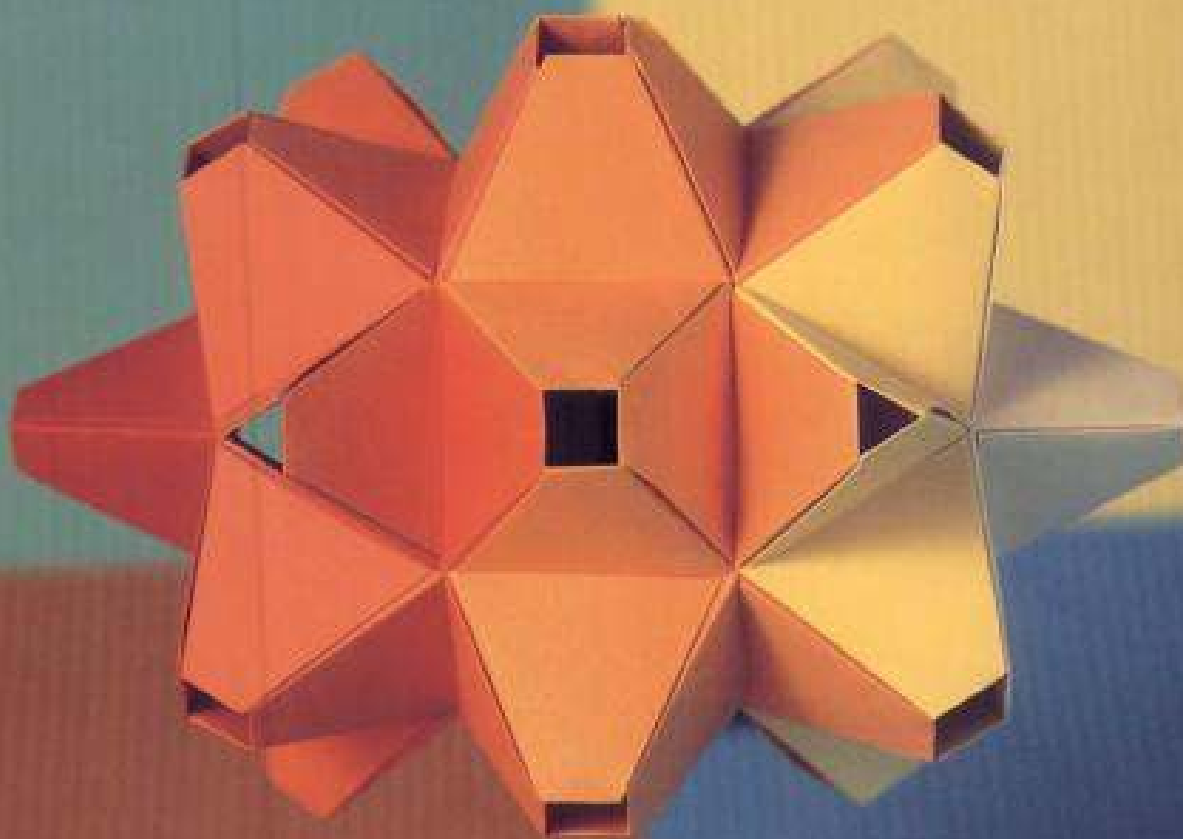
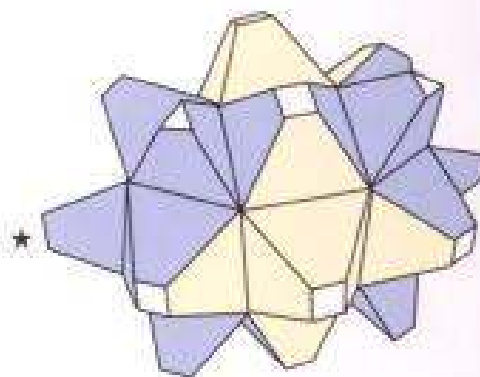

Double-sided convex hexagonal ring (p. 54)

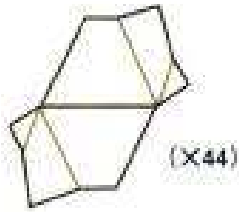

[Framework Shape]

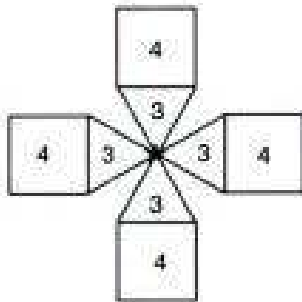
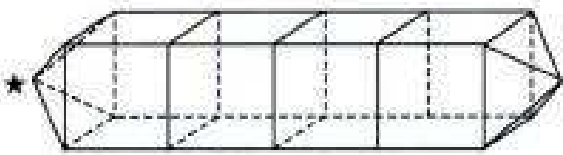

The framework shape viewed lengthwise:
(Intermediate stage)

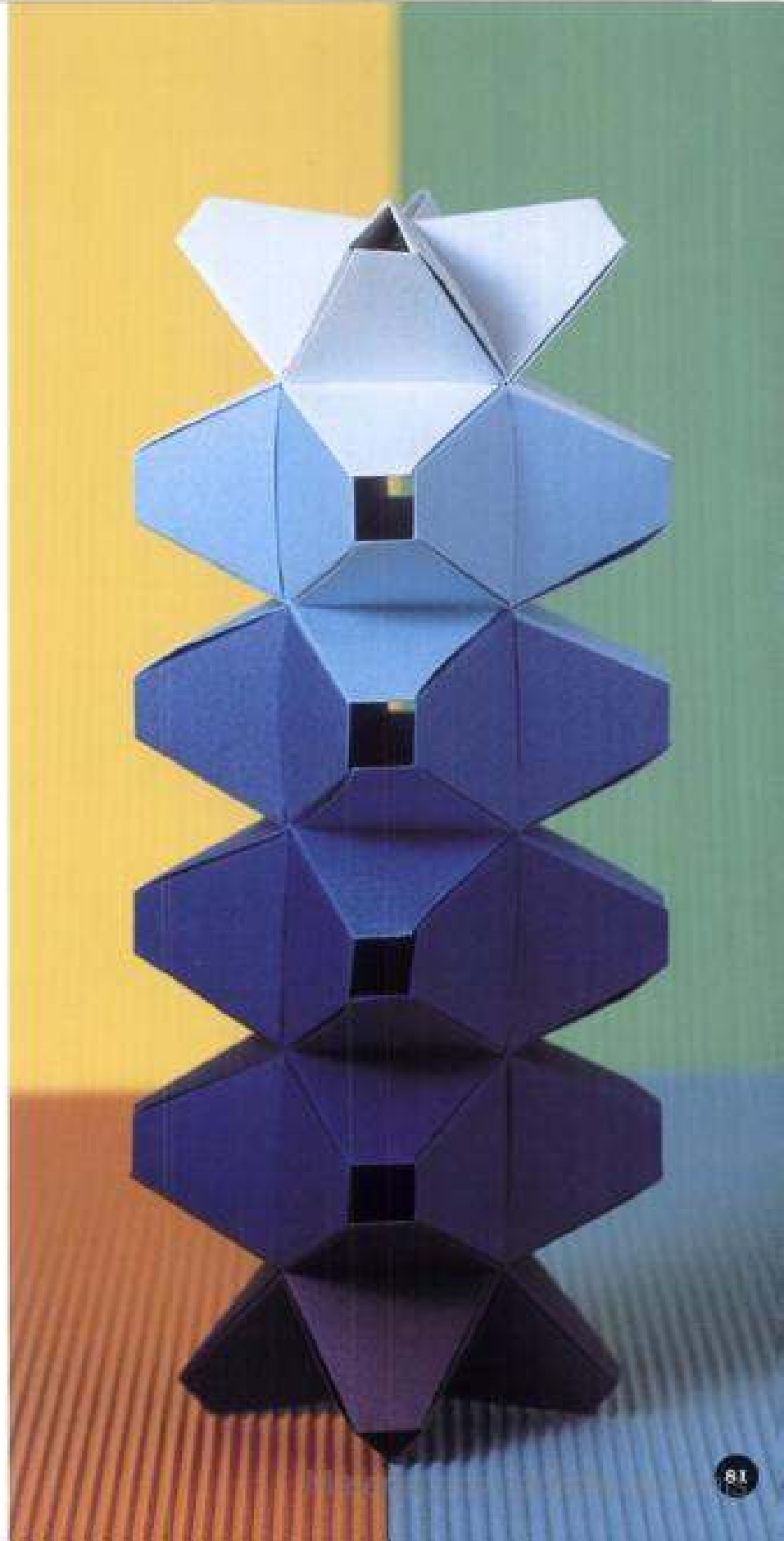
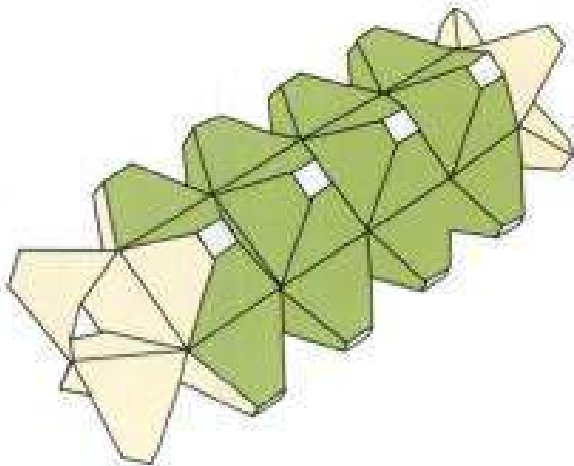

Double-sided concave hexagonal ring (p.68)

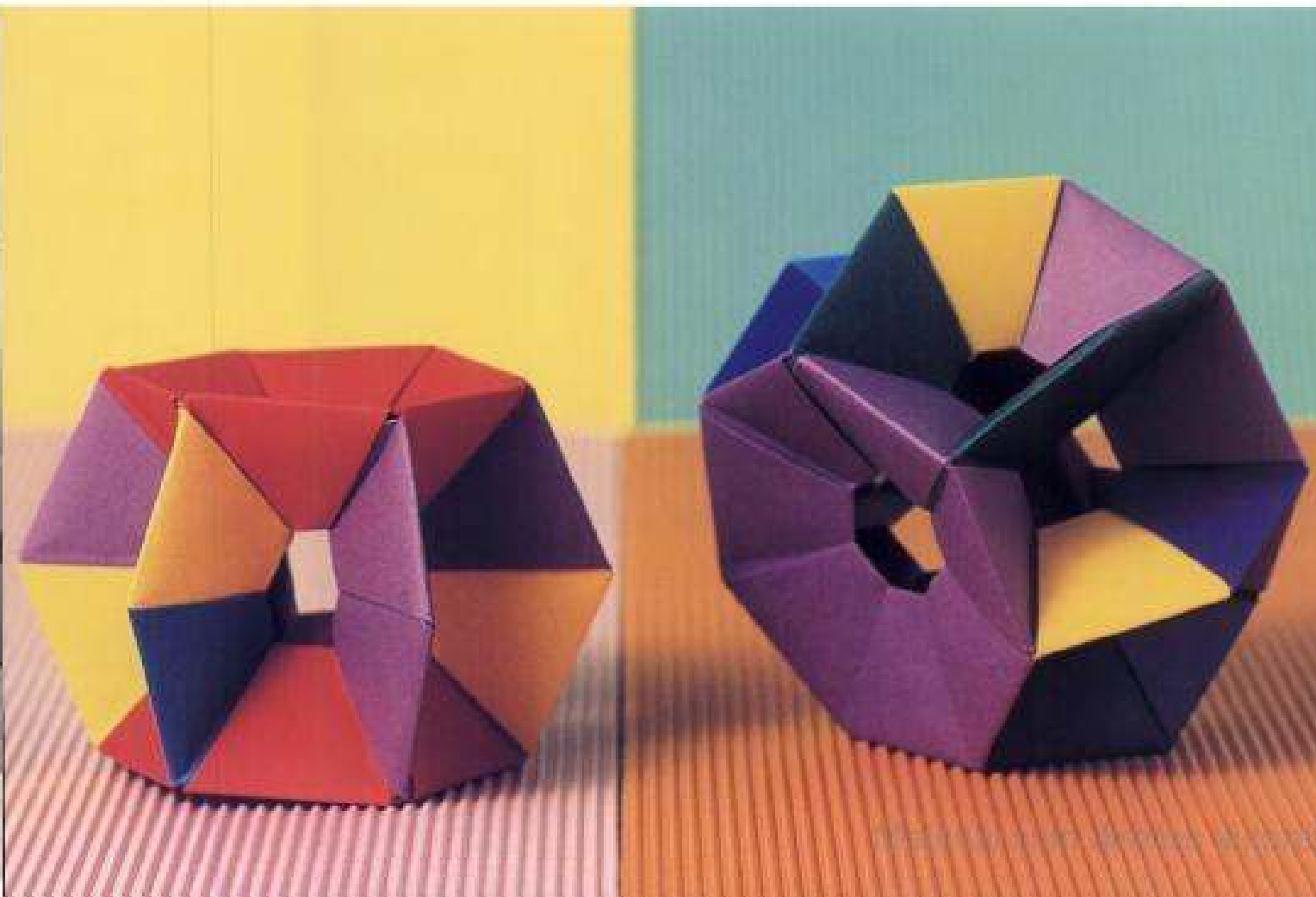
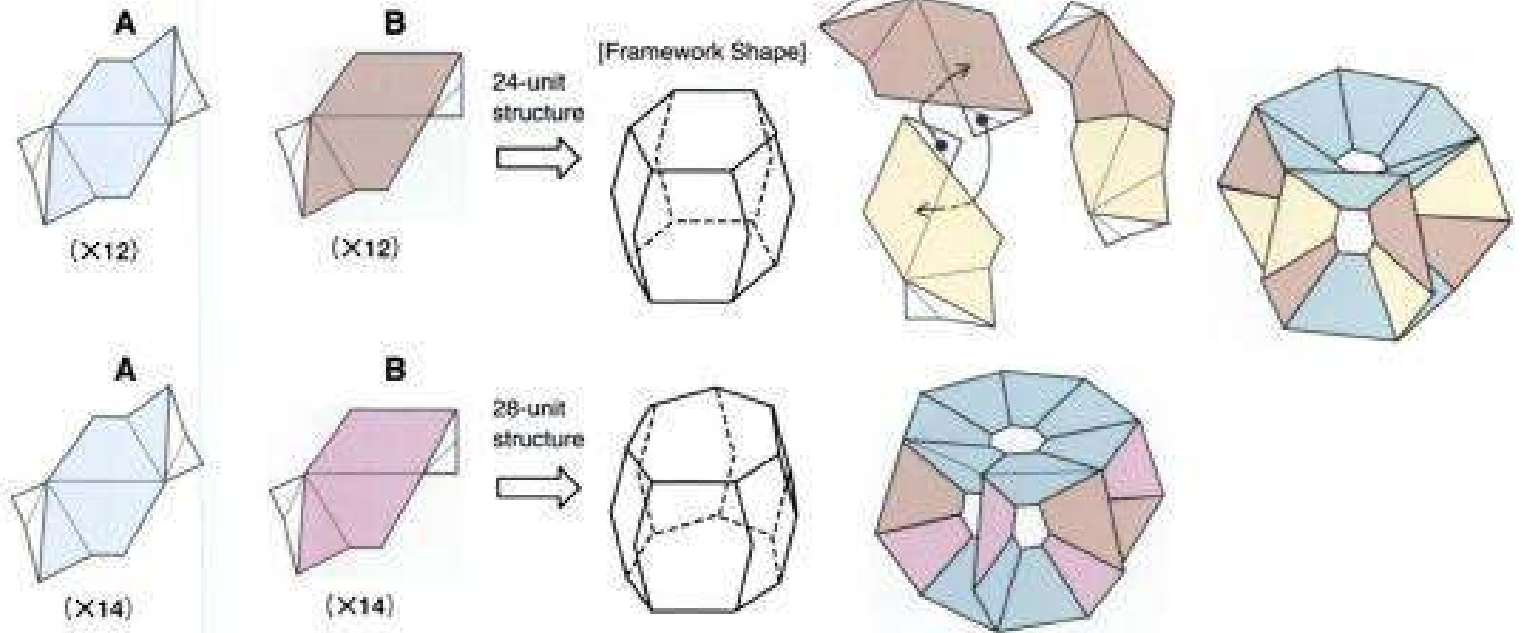

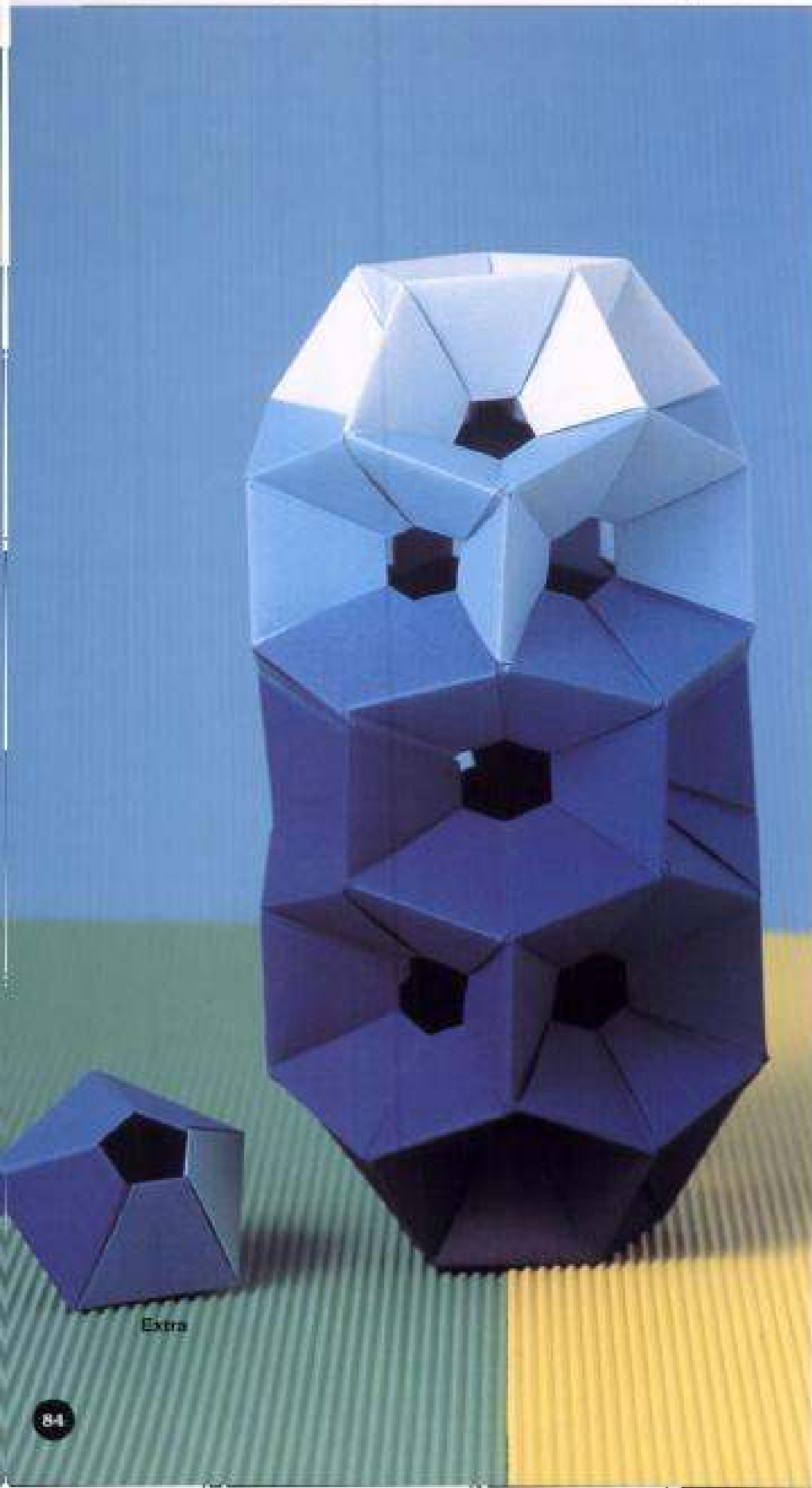

Double-sided concave
hexagonal ring (p. 68)

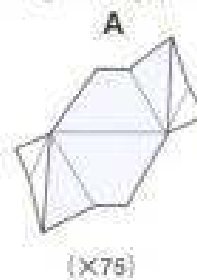

[Framework Shape]

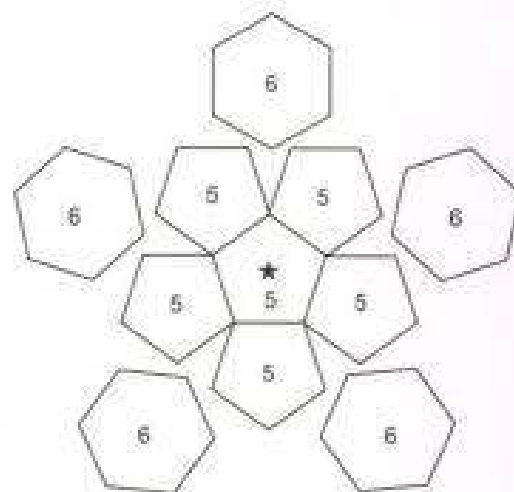
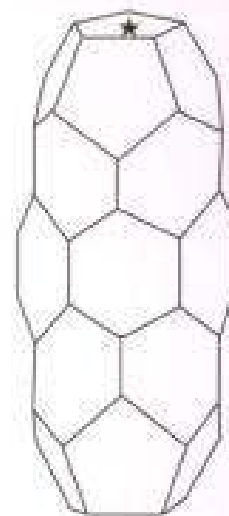

The framework shape viewed lengthwise:
(Intermediate stage)

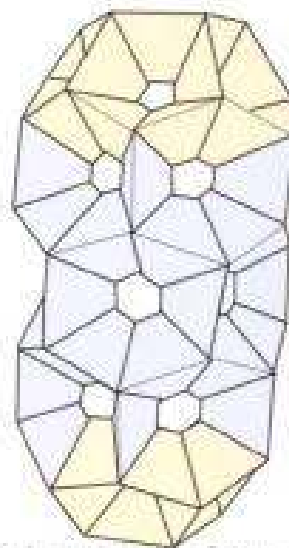

Double-sided convex hexagonal ring (p.54)



(X3)

Double-sided concave hexagonal ring (p.68)

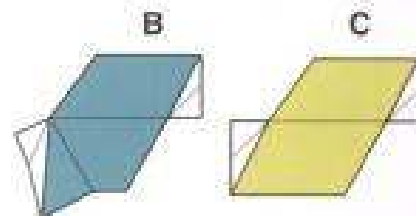

(X42)

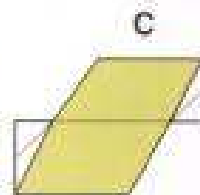

(X24)

[Core Solid]

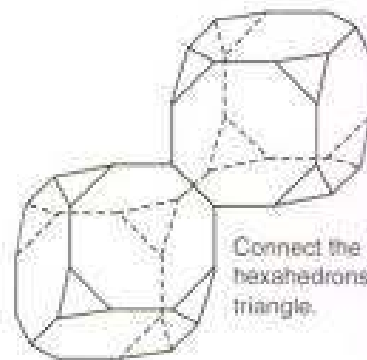

Connect the truncated hexahedrons at the triangle.

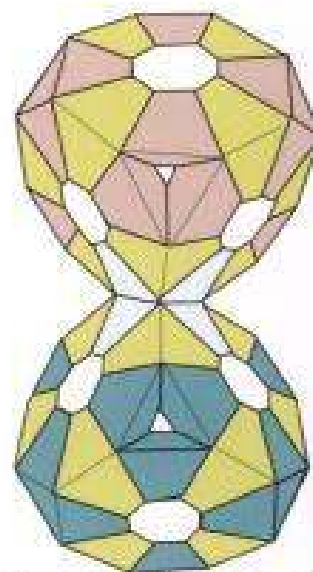

Double-sided convex hexagonal ring (p.54)

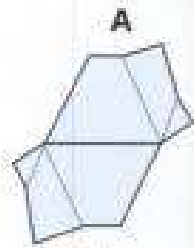

(×24)

Double-sided concave hexagonal ring (p.68)

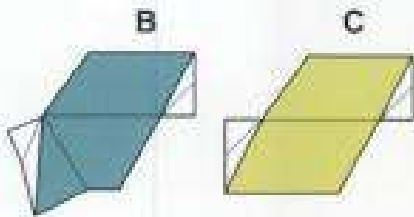

(×12)

(×12)

[Core Solid]

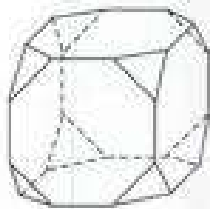

Connect the 3-unit assemblies at the triangle of truncated hexahedrons.

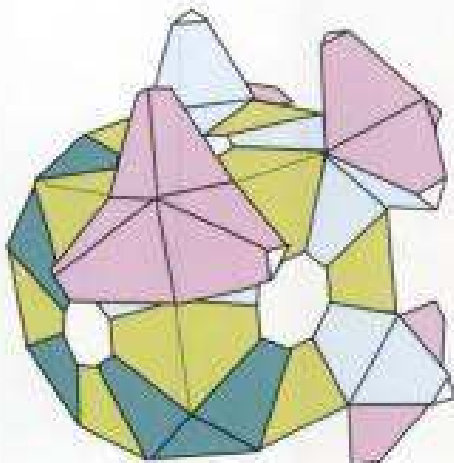

If you use convex units for jointing, you can connect solids made of concave units. Devise your own variations and try to construct different shapes. You can figure out how to make forms other than spherical shapes.

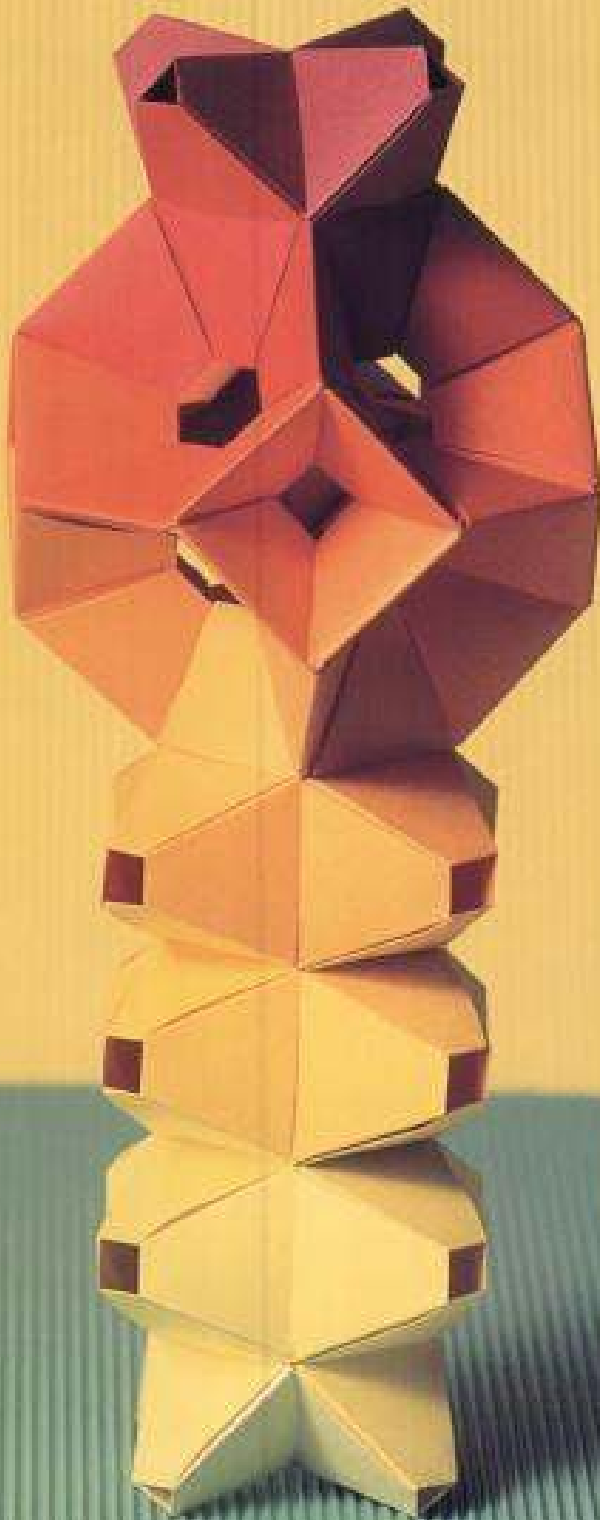

Double-sided convex hexagonal ring (p.54)

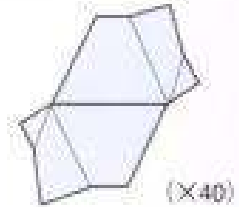

Double-sided concave hexagonal ring (p.68)

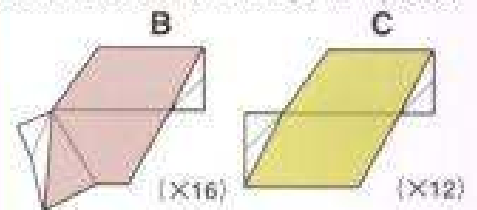

[Core Solid]

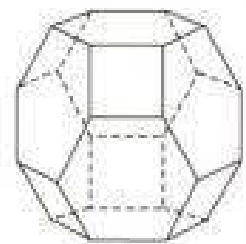

Connect the double-sided convex hexagonal rings to the square.

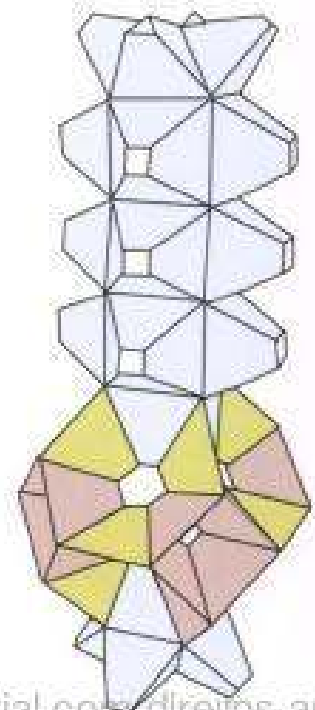

Double-sided convex hexagonal ring (p.54)

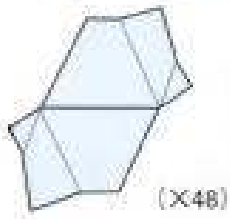

(X48)

Double-sided concave hexagonal ring (p.68)

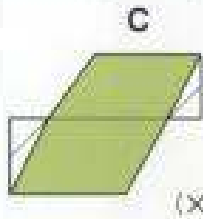

(X12)

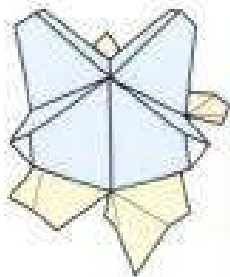

Six-unit structure of double-sided convex hexagonal rings. The bottom is square.



[Core Solid]

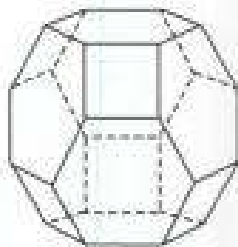

Connect 8-unit assemblies of double-sided convex hexagonal rings at the square.

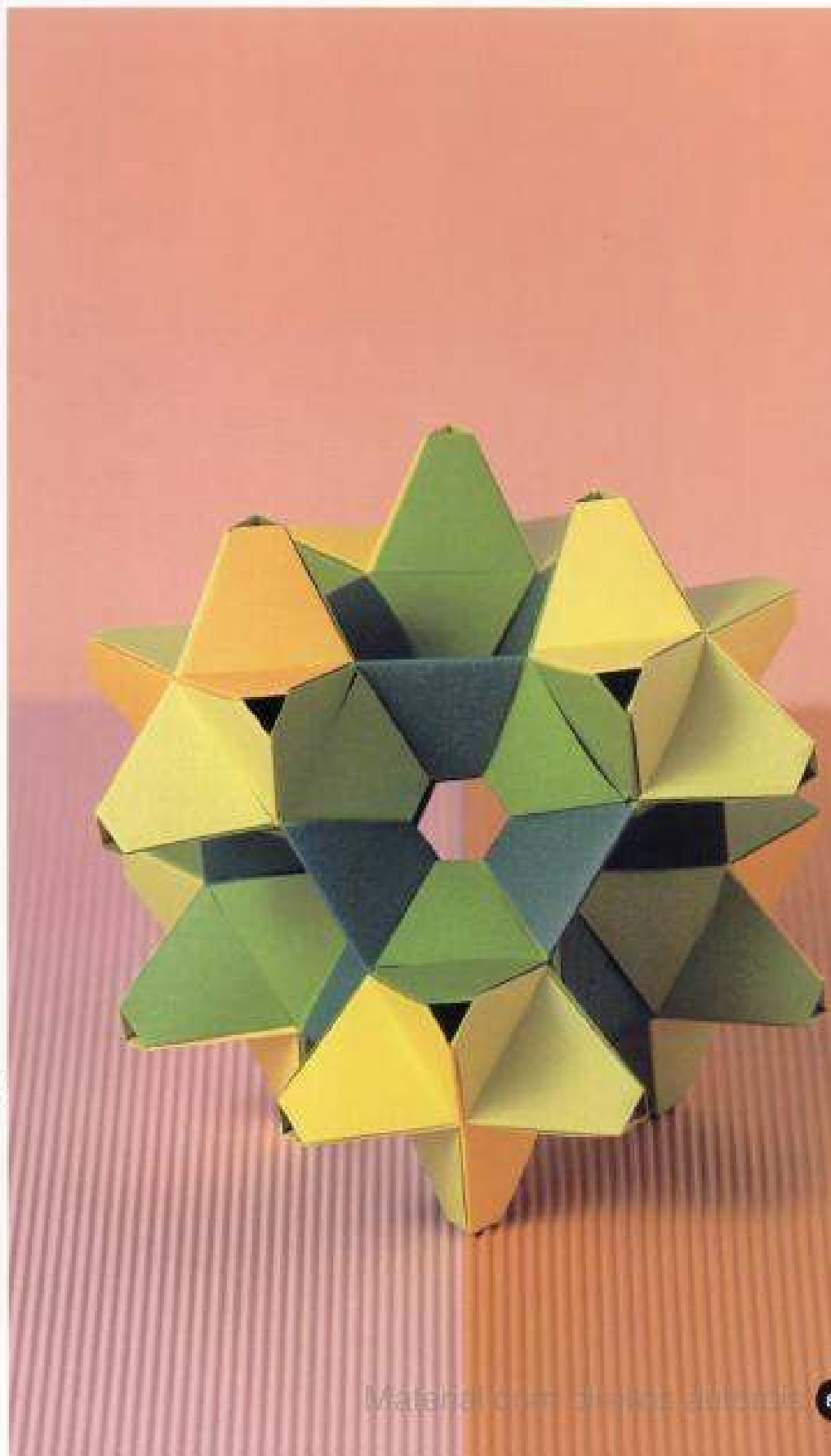
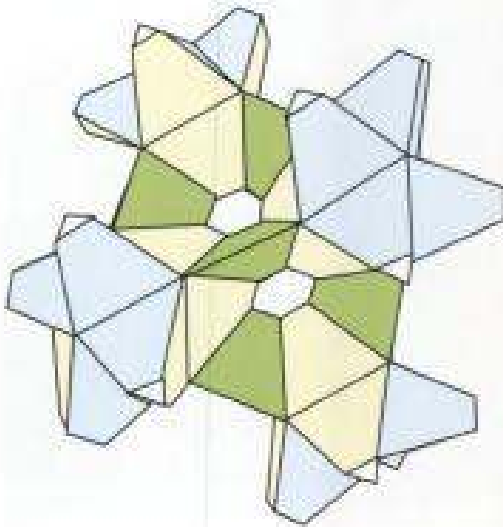

9

DIAGONALLY FOLDED TRIANGULAR-UNIT SOLIDS

This unit is made from rectangular paper, which is made from square paper cut in half, with a basic crease made diagonally. The finished solids are sturdy. Shown here are models with polyhedrons at their core.



6-UNIT STRUCTURE /p.94

30-UNIT STRUCTURE /p.95

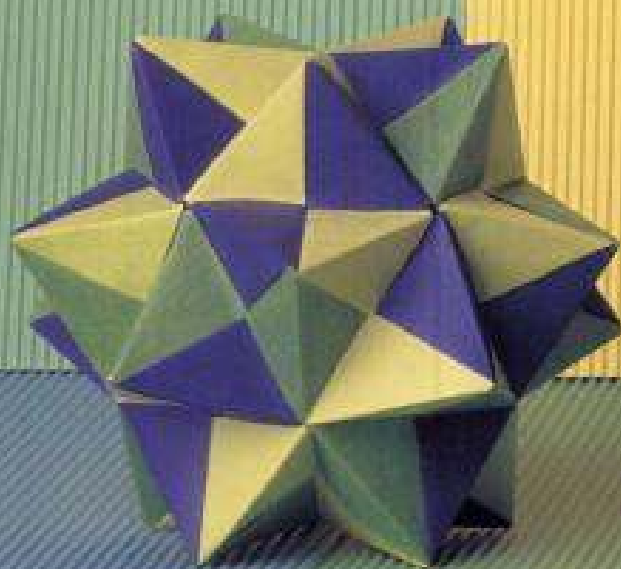

24-UNIT STRUCTURE /p.96





12-UNIT STRUCTURE /p.94

48-UNIT STRUCTURE /p.97



60-UNIT STRUCTURE /p.98

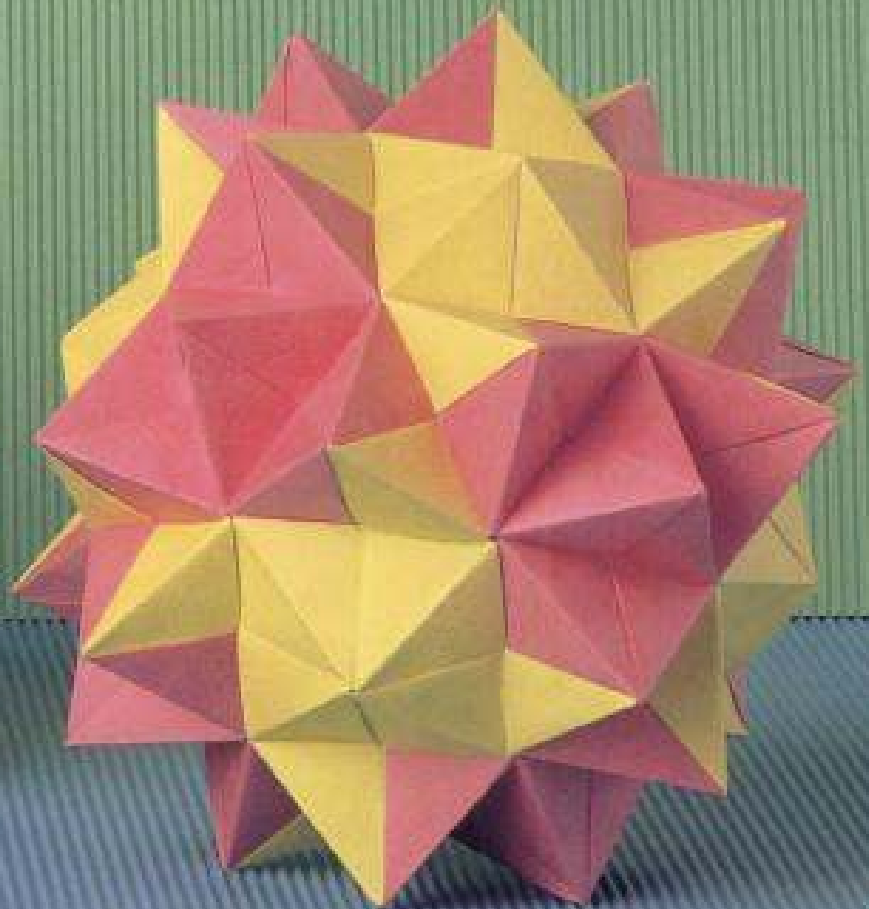

DIAGONALLY FOLDED TRIANGULAR UNIT

level ★★ 12cm × 6cm

The hooks on the unit make the solid as sturdy as the double-sided hexagonal ring. It is easier to fold than you might think.

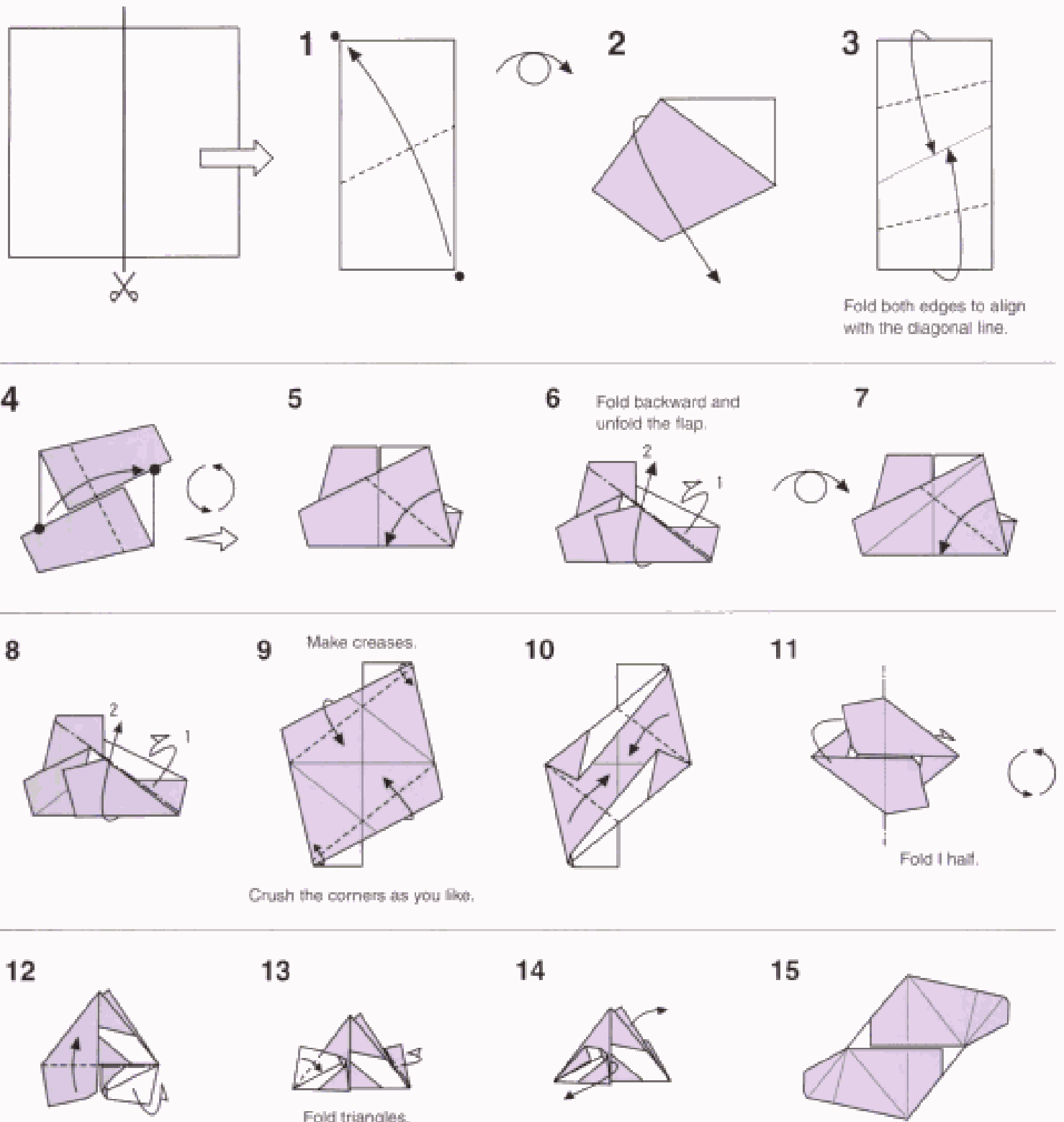

HINT ON ASSEMBLY 1

Insert the shaded part deep into the slit of the other unit. The tip works as a hook and makes the structure sturdy.

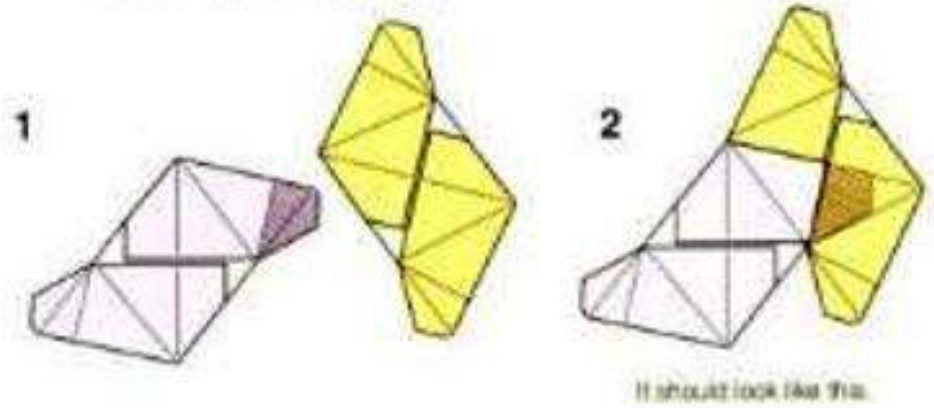

3-unit structure

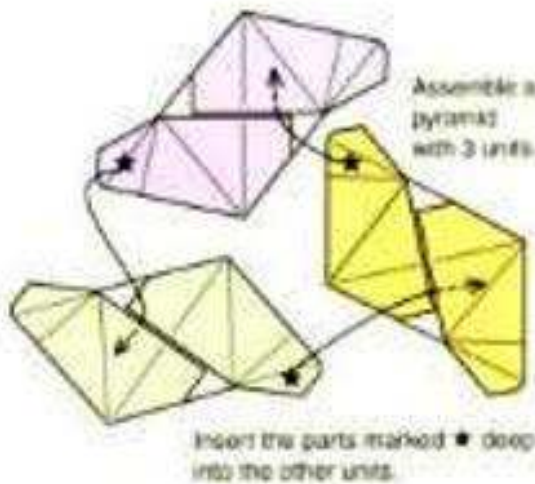

4-unit structure

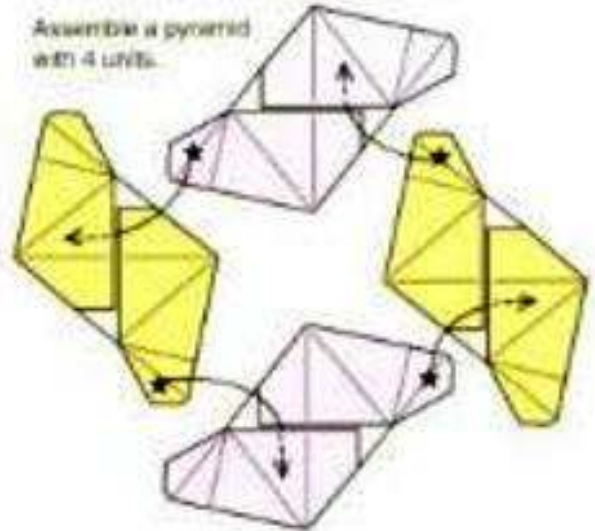

HINT ON ASSEMBLY 2

The bottom of each element is a triangle or a square, and each pyramid stands on it. This element lets you assemble a variety of solids. The double-sided convex hexagonal ring (p. 54) had a window on top, but these pyramids have no windows. The assembly method is the same as that of the double-sided convex hexagonal ring, but the slope of the top triangle is so gentle that you cannot assemble five-sided or six-sided pyramids.

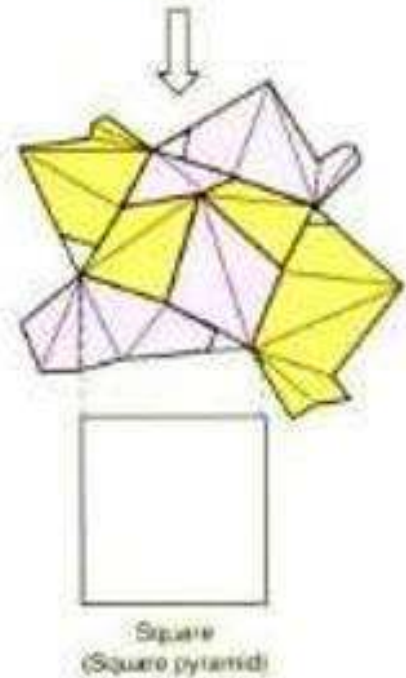
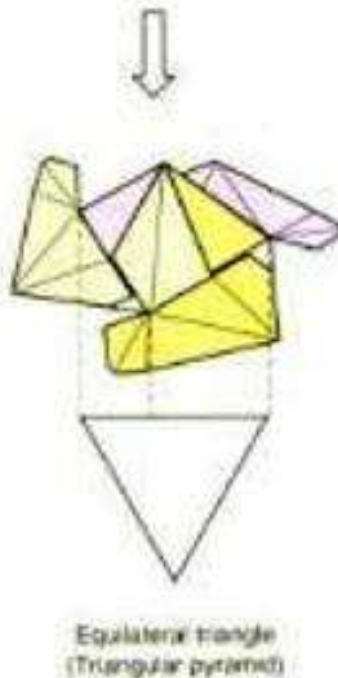

6-UNIT STRUCTURE

Regular Tetrahedron Star

12-UNIT STRUCTURE

Regular Octahedron Star

level ★

12cm x 6cm

Triangle Unit (p. 92)

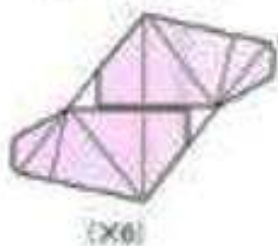

Begin with a 3-unit structure.

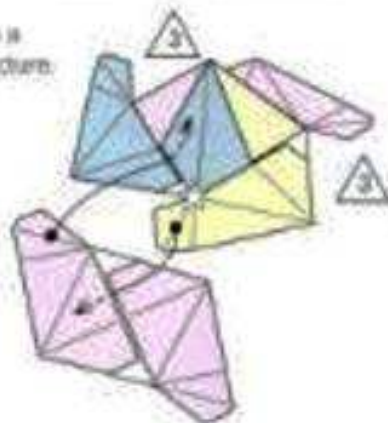

Regular Tetrahedron Star

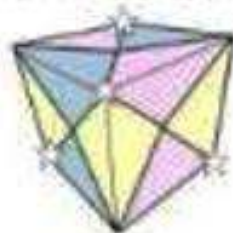

Three triangular pyramids join at the star.



Triangle Unit (p. 92)

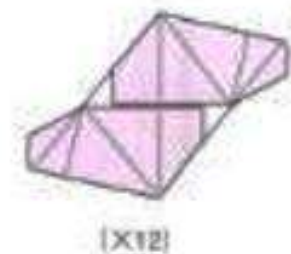

Begin with a 3-unit structure.

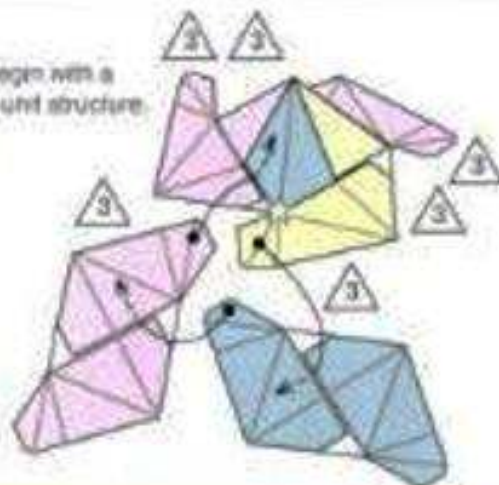

Regular Octahedron Star

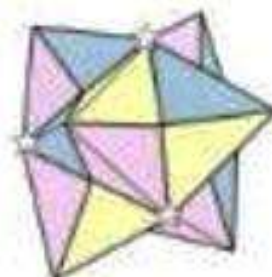

Four triangular pyramids join at the star.

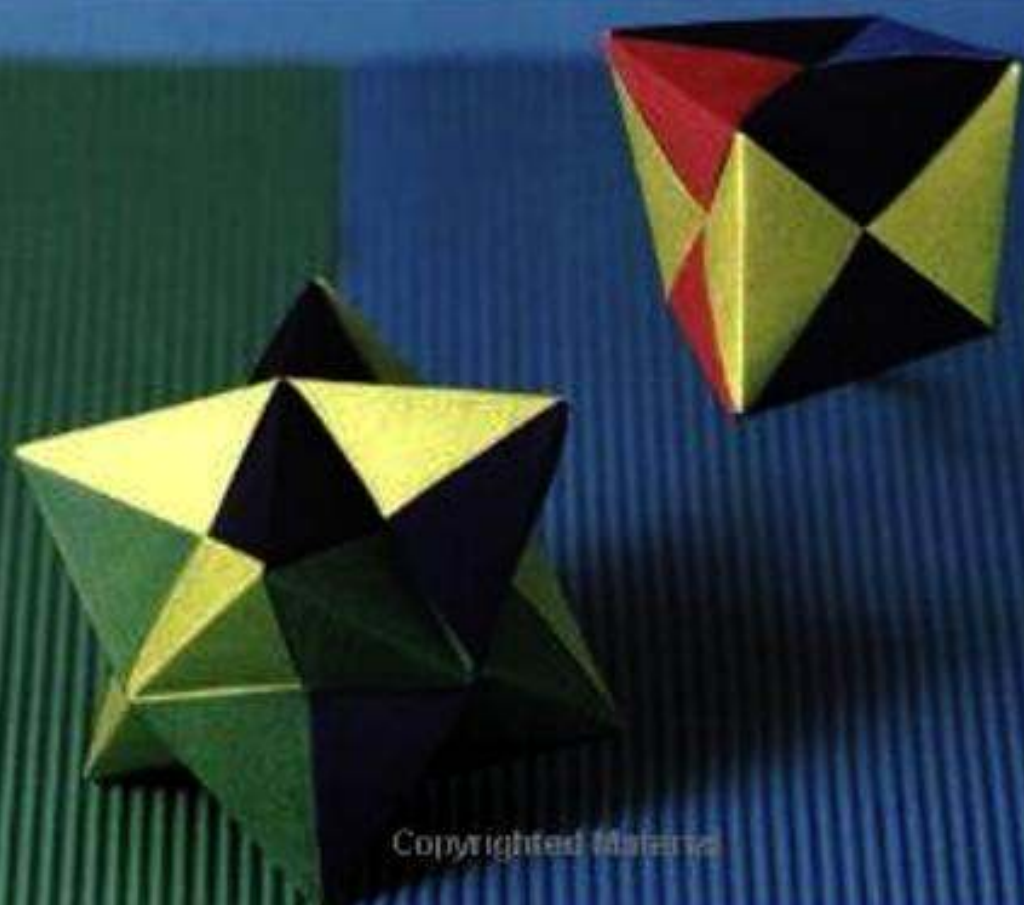
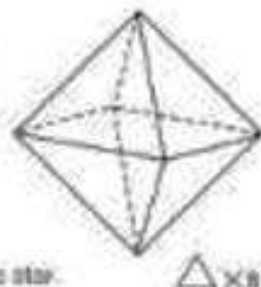

Triangle Unit (p. 92)

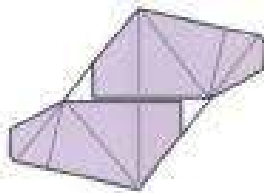

(×30)

Begin with a 3-unit structure.

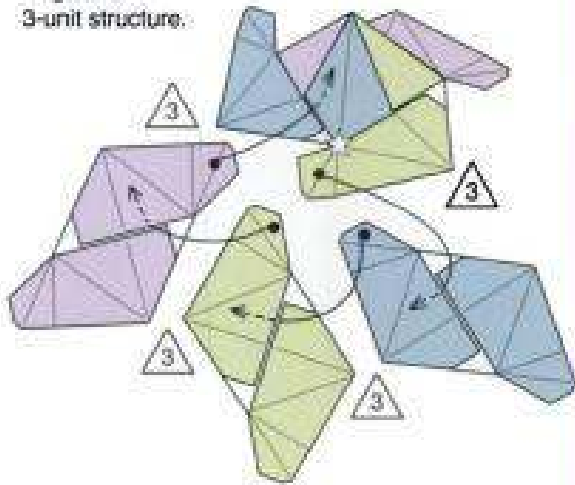

Five triangular pyramids join at the star.



Regular Icosahedron Star

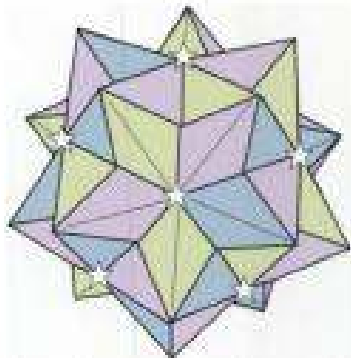

Five triangular pyramids gather at the star.

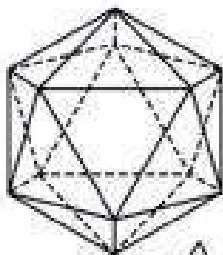

△ × 20

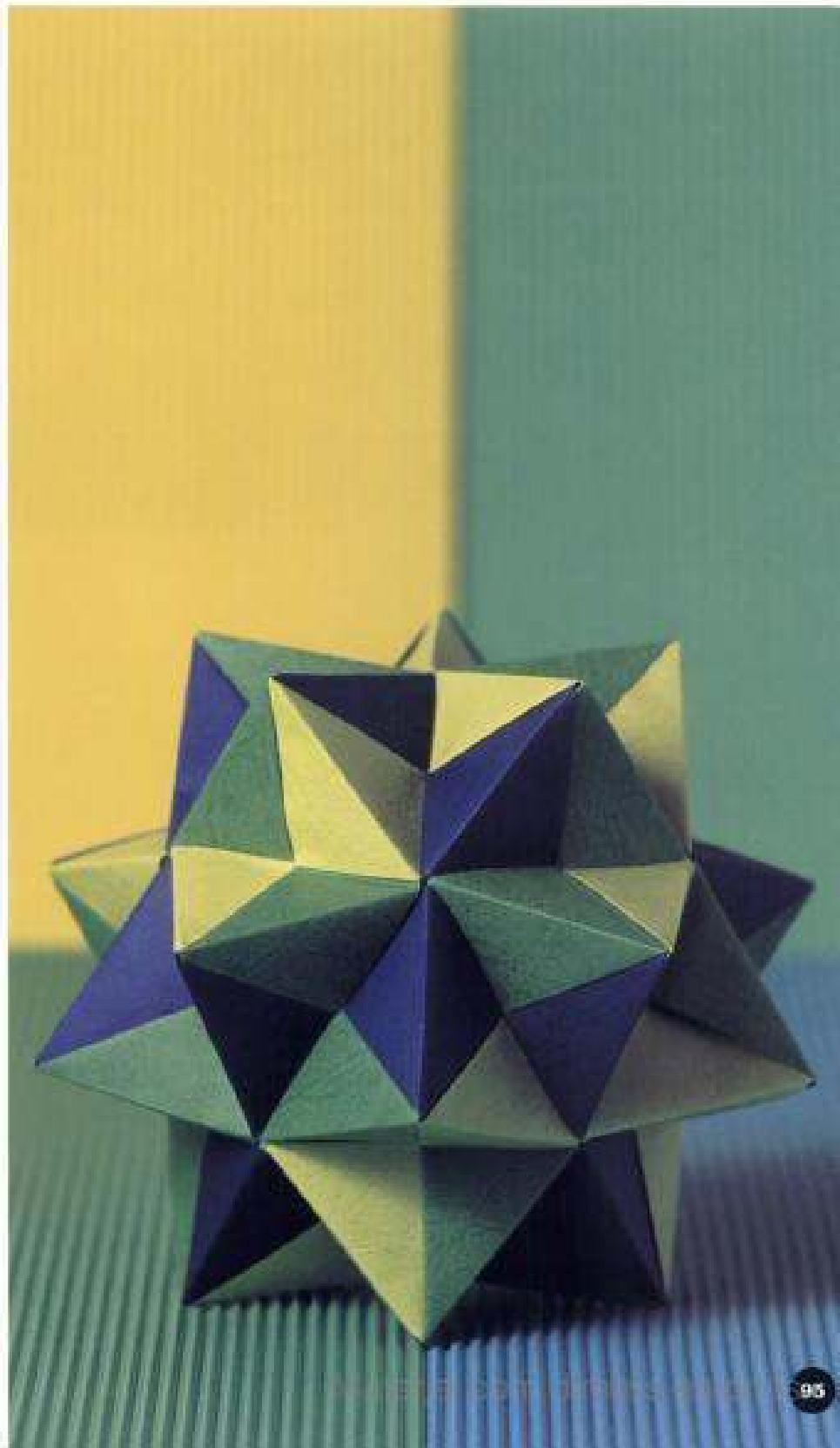

24-UNIT STRUCTURE Cuboctahedron Star level ★★

12cm × 6cm

Triangular Unit (p. 92)

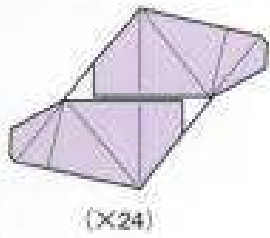

Begin with a 4-unit structure.

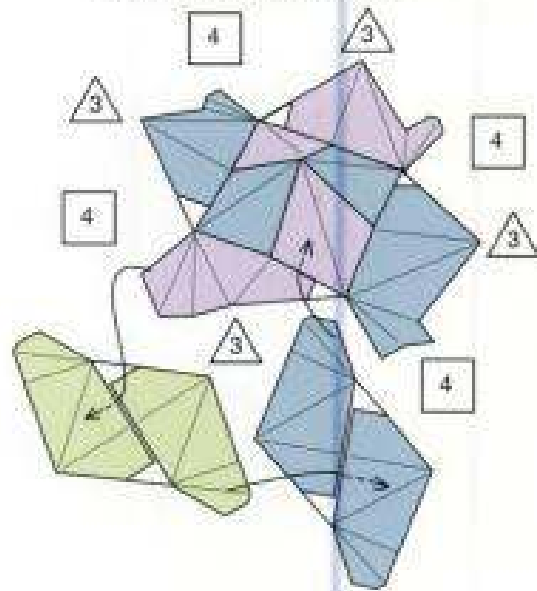

Cuboctahedron Star

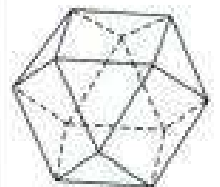
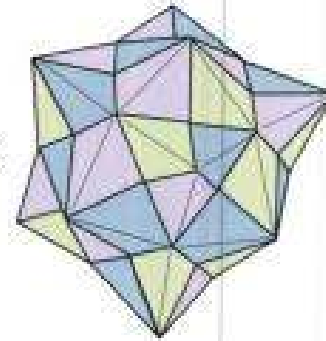

△ x 8 □ x 6

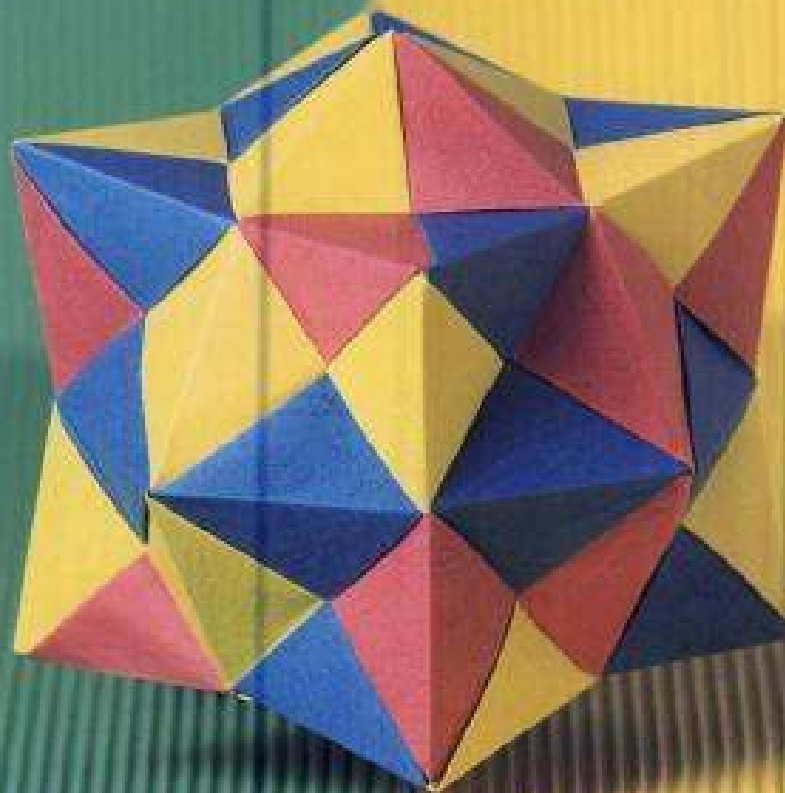

Triangular Unit (p. 92)

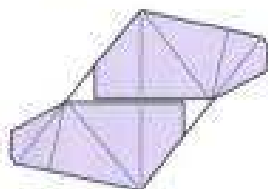

(×48)

Begin with a 4-unit structure.

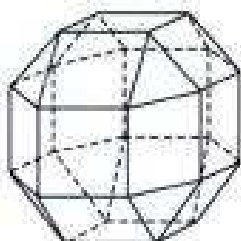
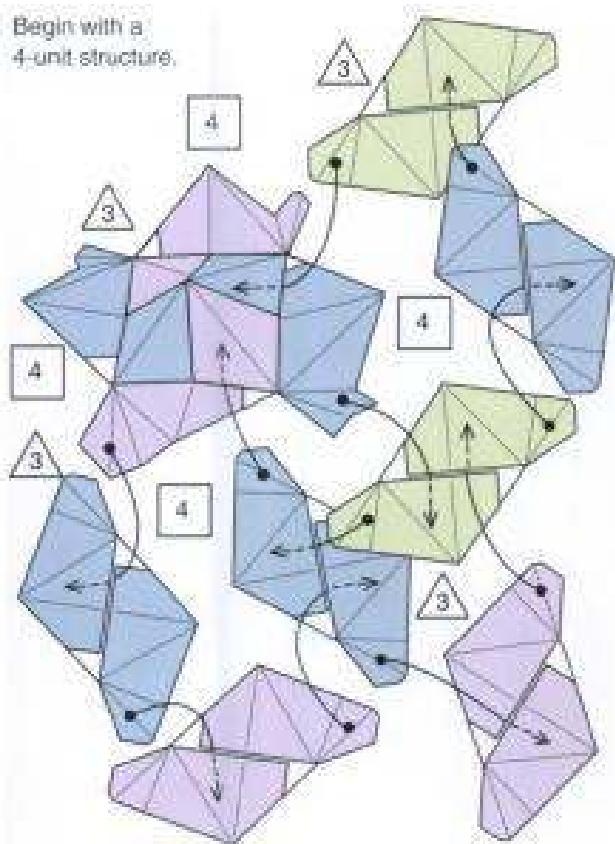

△ × 8 □ × 18

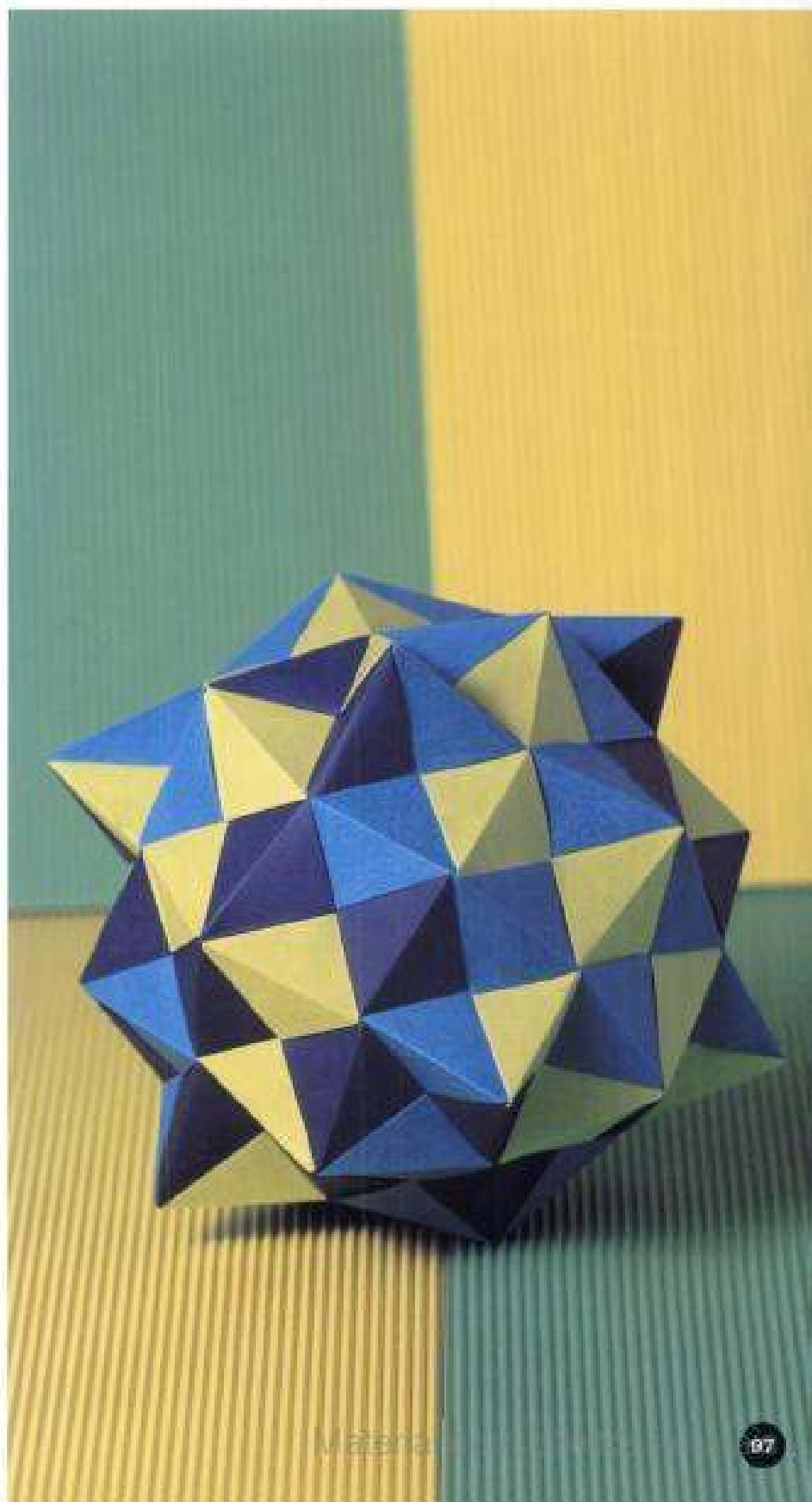

Triangle Unit (p. 92)

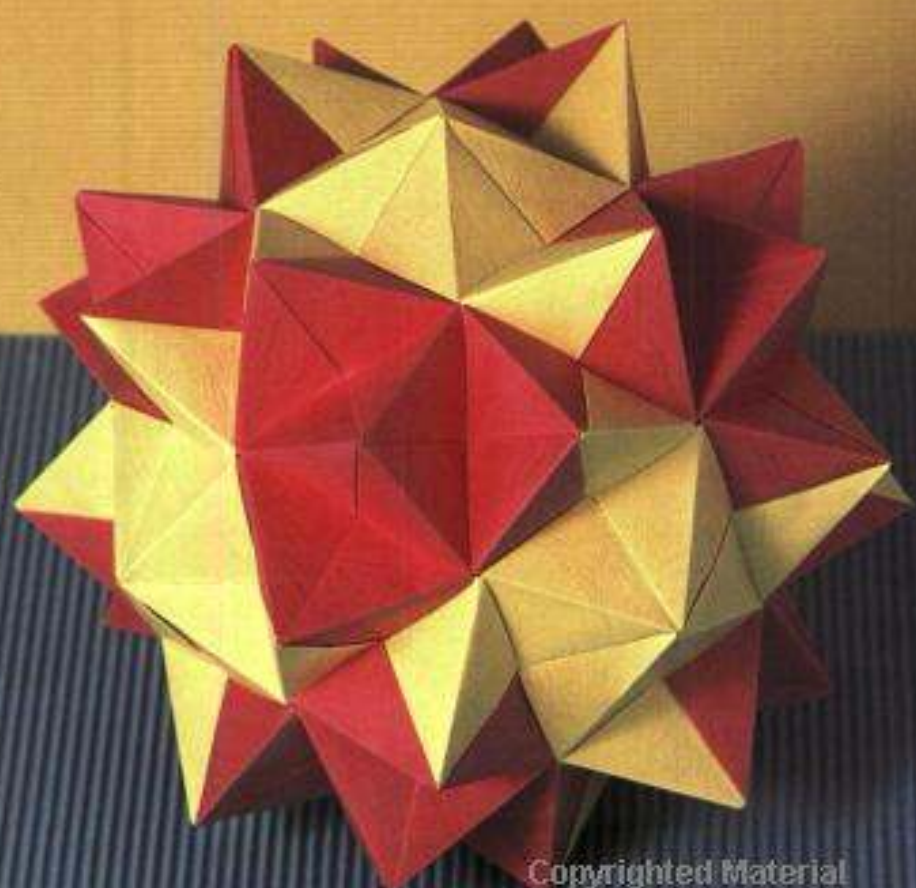
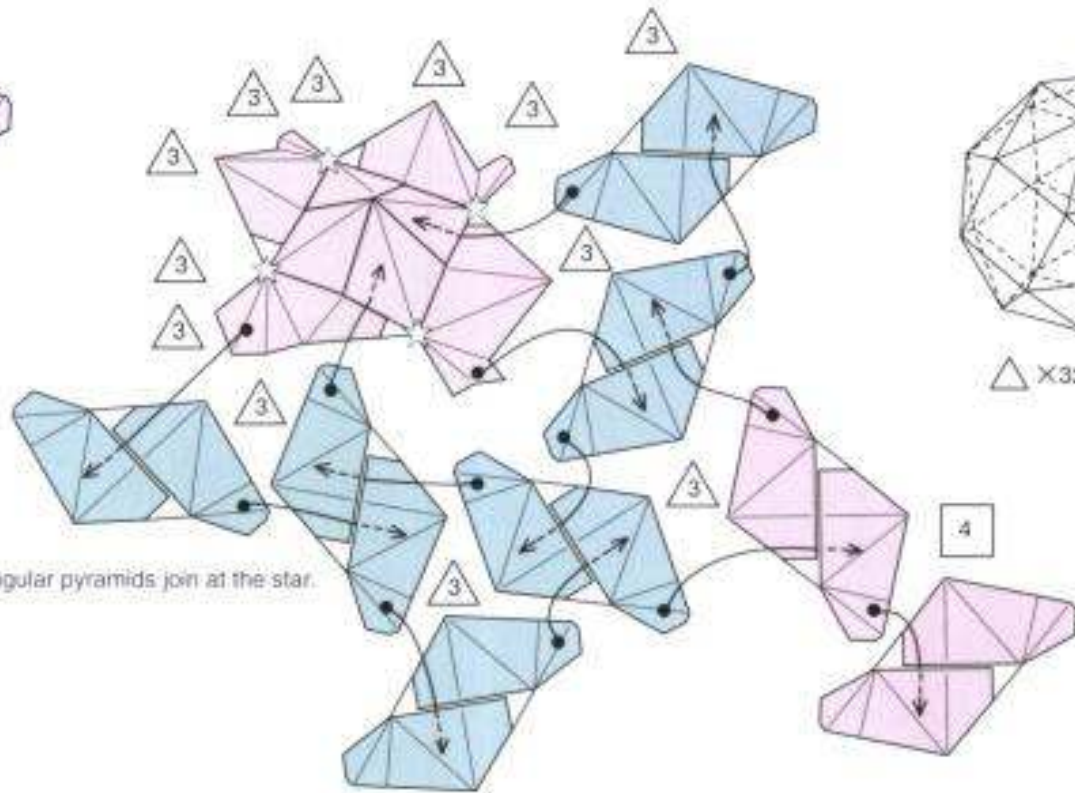
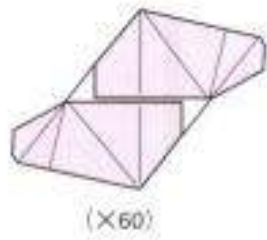

POLYHEDRONS

Copyrighted Material
Polyhedrons used in this book.

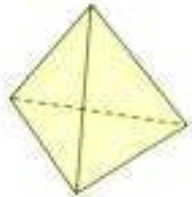

Regular tetrahedron

$\triangle \times 4$
6 sides
4 apices

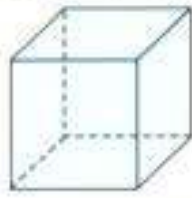

Regular hexahedron (Cube)

$\square \times 6$
12 sides
8 apices

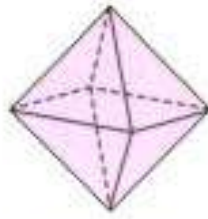

Regular octahedron

$\triangle \times 8$
12 sides
6 apices

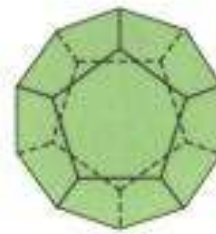

Regular dodecahedron

$\text{pentagon} \times 12$
30 sides
20 apices



Regular icosahedron

$\triangle \times 20$
30 sides
12 apices

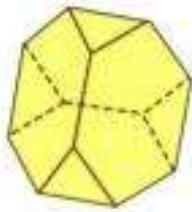

Truncated tetrahedron

$\triangle \times 4$ $\square \times 4$
18 sides
12 apices

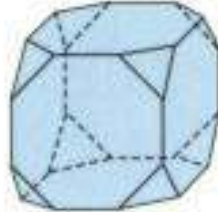

Truncated hexahedron

$\triangle \times 8$ $\square \times 6$
36 sides
24 apices

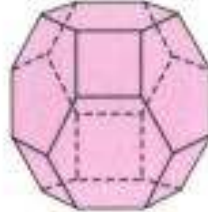

Truncated octahedron

$\square \times 6$ $\text{hexagon} \times 8$
36 sides
24 apices



Truncated dodecahedron

$\triangle \times 20$ $\square \times 12$
90 sides
60 apices

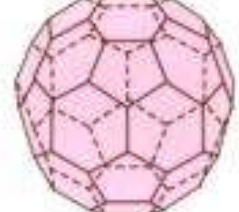

Truncated icosahedron

$\text{pentagon} \times 12$ $\text{hexagon} \times 20$
90 sides
60 apices

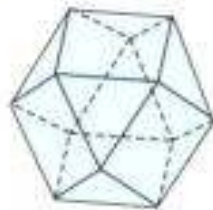

Cuboctahedron

$\triangle \times 8$ $\square \times 6$
24 sides
12 apices

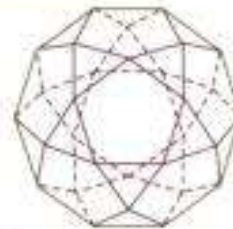

Icosa-dodecahedron

$\triangle \times 20$ $\text{pentagon} \times 12$
60 sides
30 apices

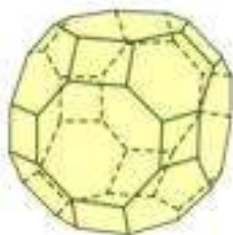

Rhombic truncated octahedron

$\square \times 12$ $\text{hexagon} \times 8$ $\square \times 6$
72 sides
48 apices

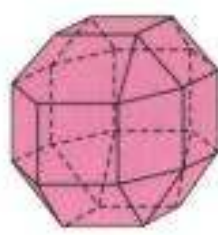

Rhombic cuboctahedron

$\triangle \times 8$ $\square \times 18$
48 sides
24 apices

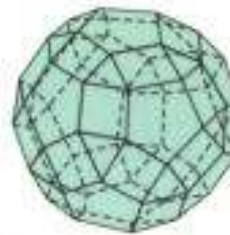

Rhombic icsa-dodecahedron

$\triangle \times 20$ $\square \times 30$ $\text{pentagon} \times 12$
120 sides
60 apices

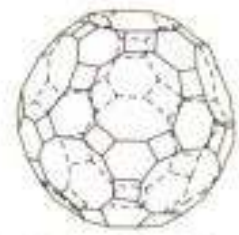

Rhombic truncated icsa-dodecahedron

$\square \times 30$ $\text{hexagon} \times 20$ $\square \times 12$
180 sides
120 apices



Variant cube

$\triangle \times 32$ $\square \times 6$
60 sides
24 apices



Variant dodecahedron

$\triangle \times 80$ $\text{pentagon} \times 12$
150 sides
60 apices

Copyrighted Material

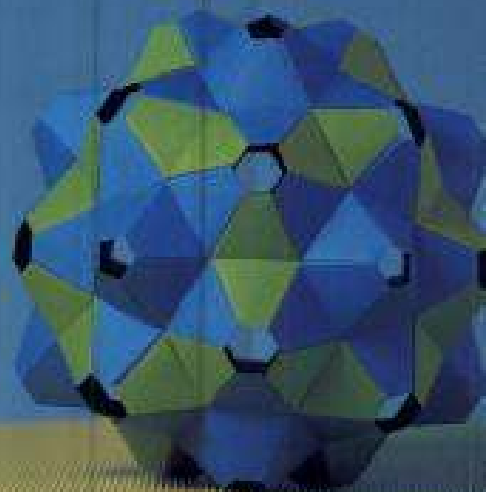
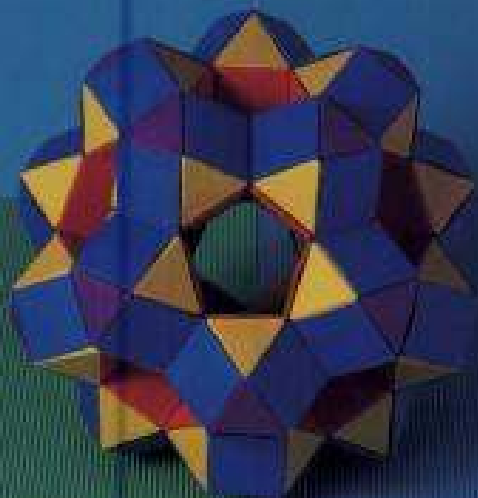
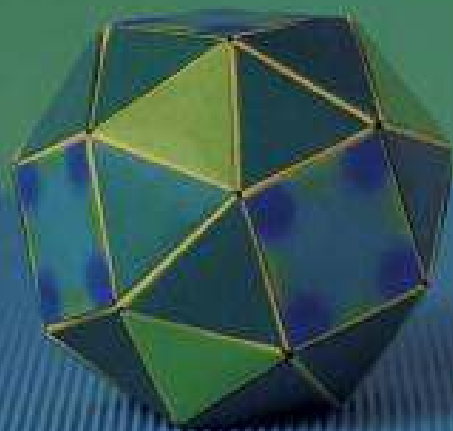

UNIT
POLYHEDRON
ORIGAMI

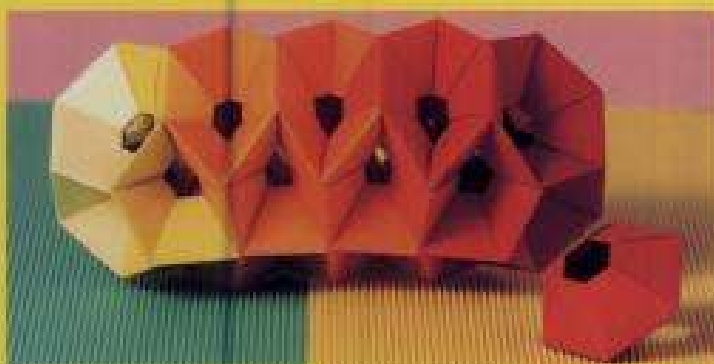

US\$20.95

ISBN 4-88996-205-0



9 784889 962055

JAPAN PUBLICATIONS TRADING CO., LTD.

Printed in Japan