

Fig. 10

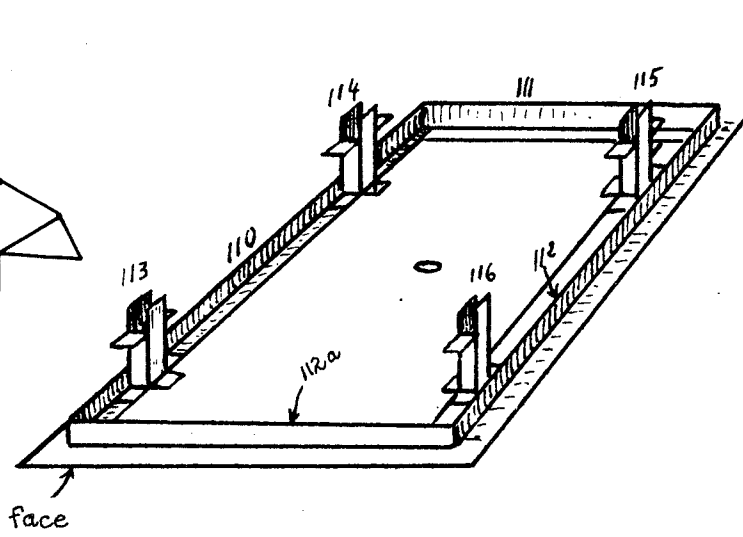

Fig. 15

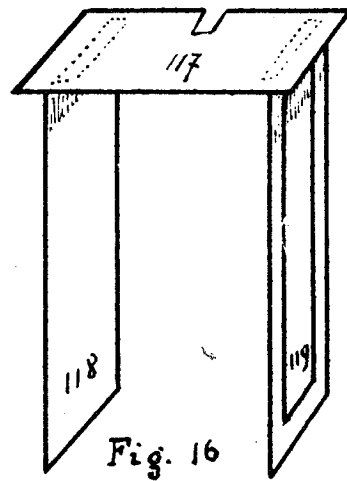

Fig. 16

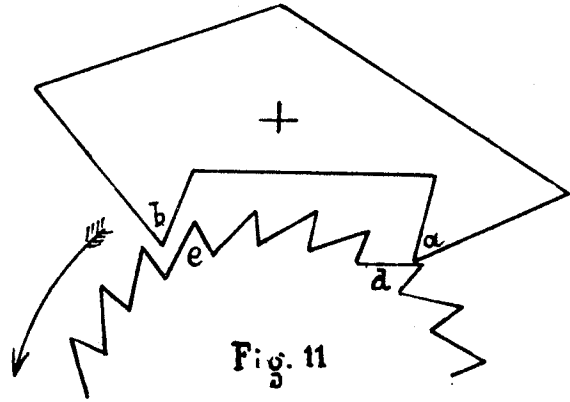

Fig. 11

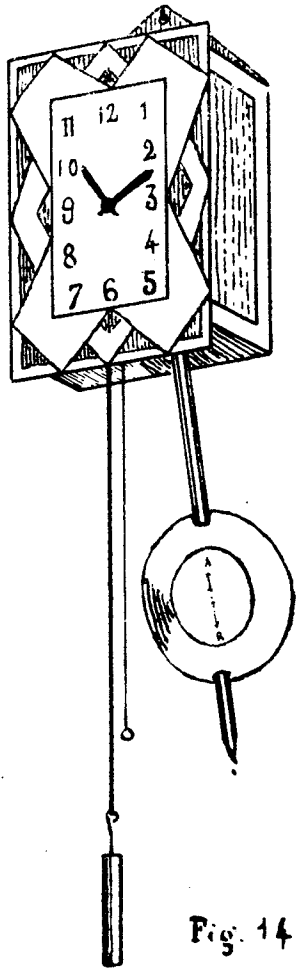

Fig. 14

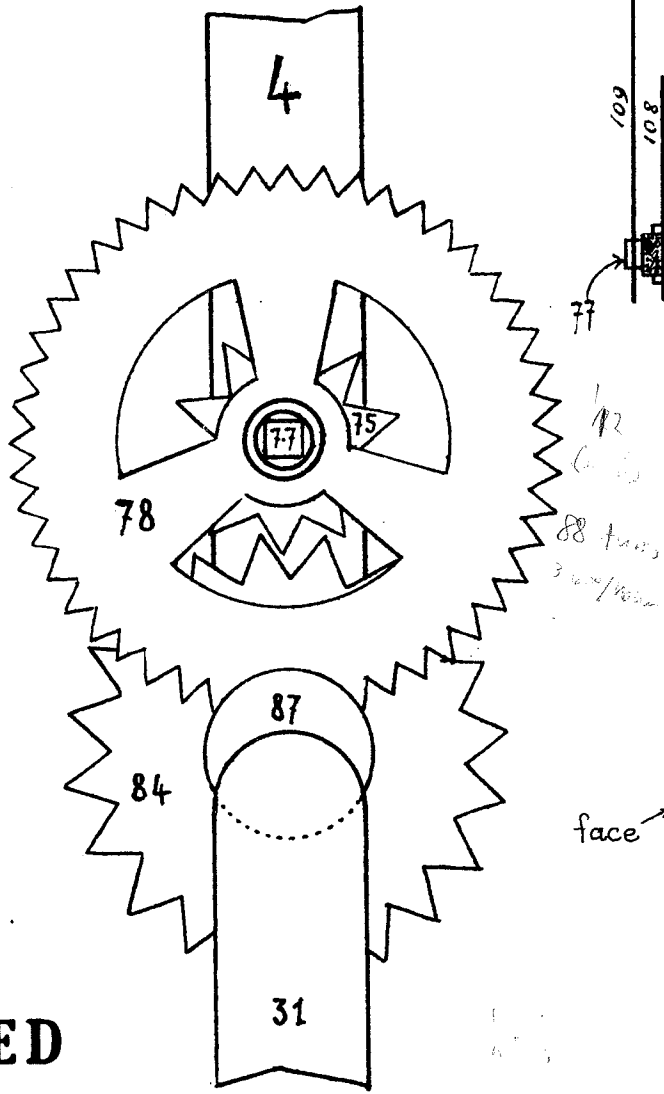

Fig. 12

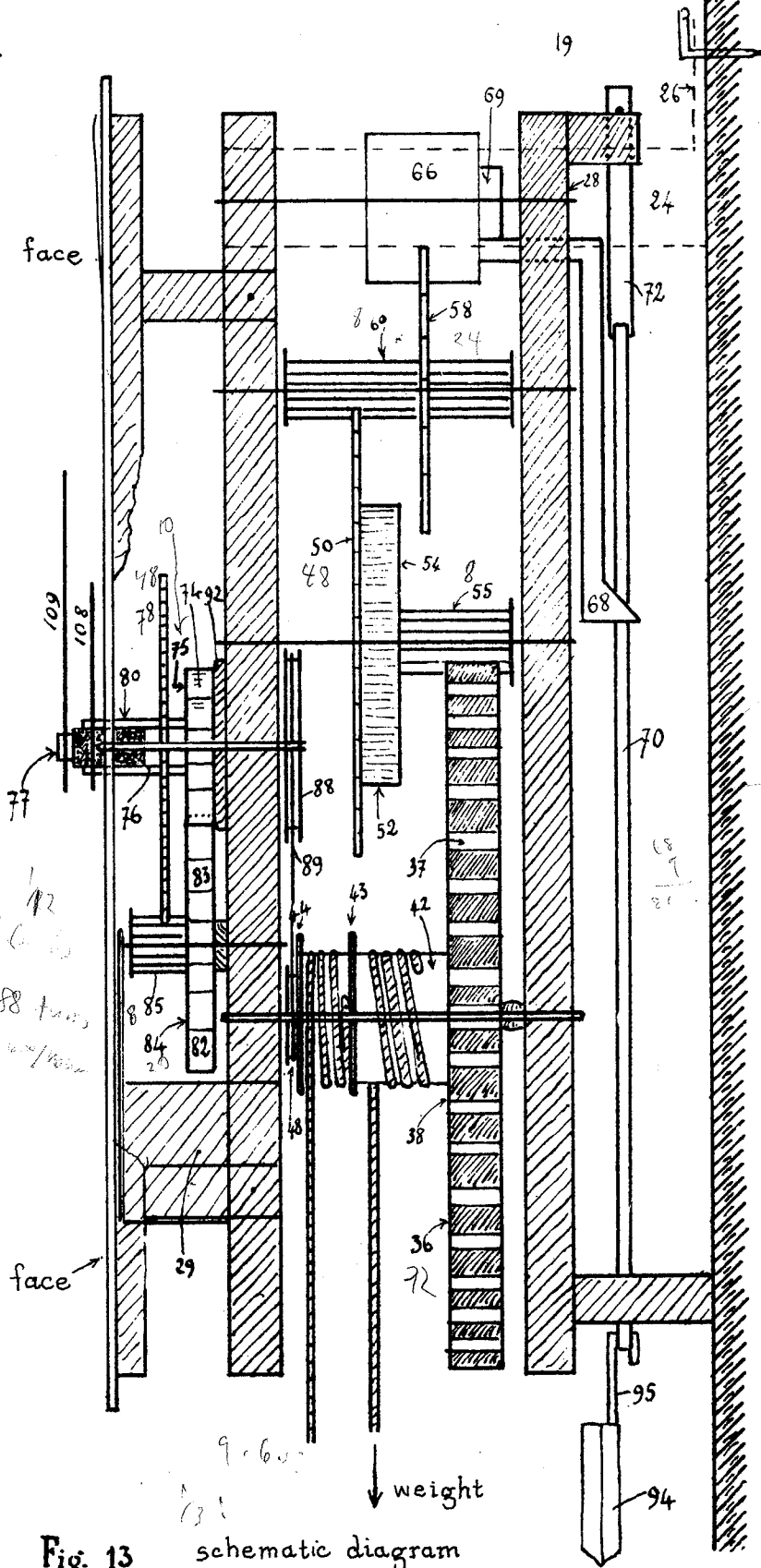

Fig. 13

schematic diagram

ASSEMBLED

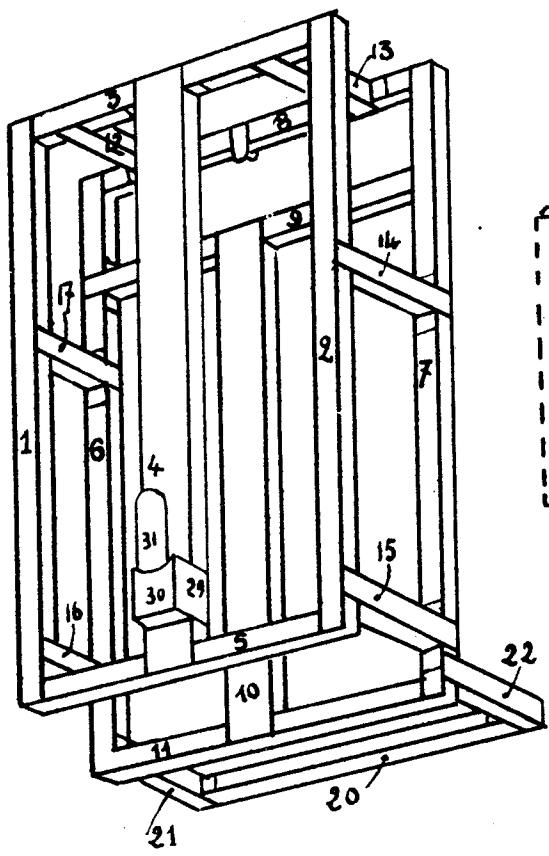

Fig. 1.

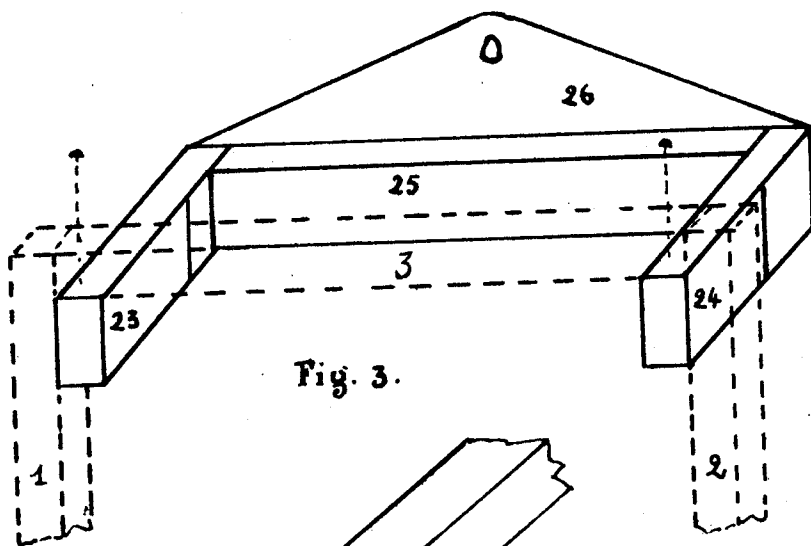

Fig. 3.

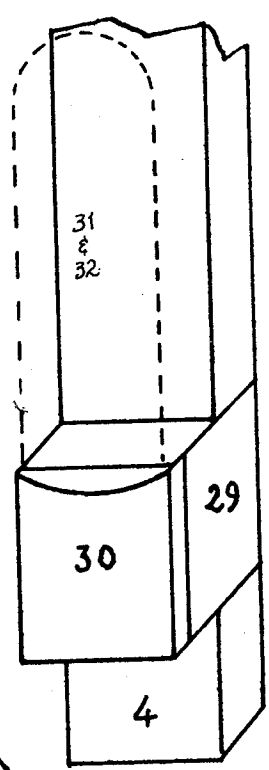

Fig. 4.

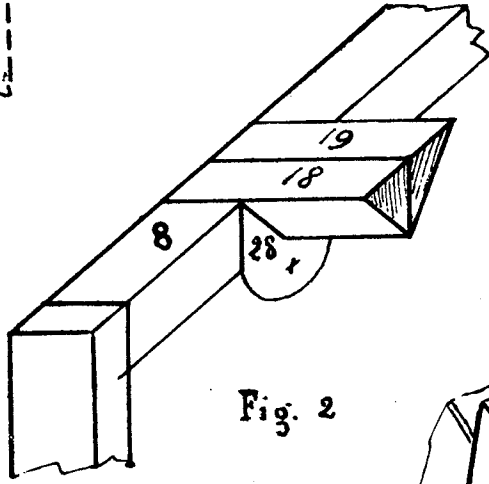

Fig. 2.

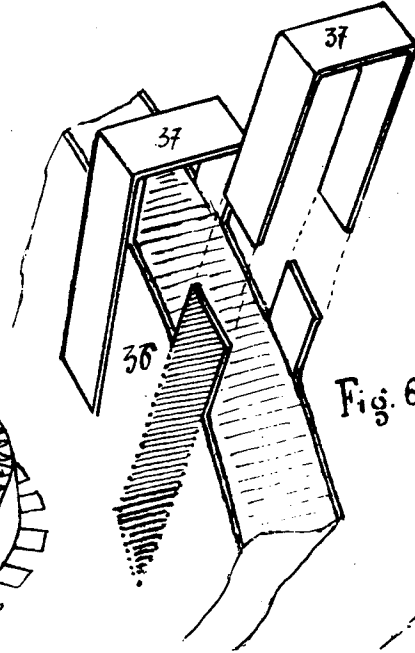

Fig. 6.

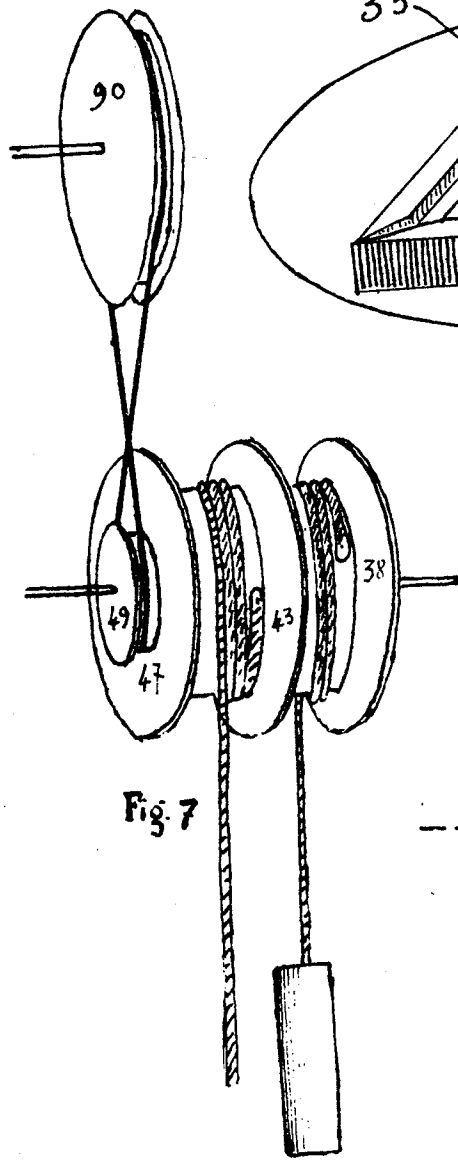

Fig. 7.

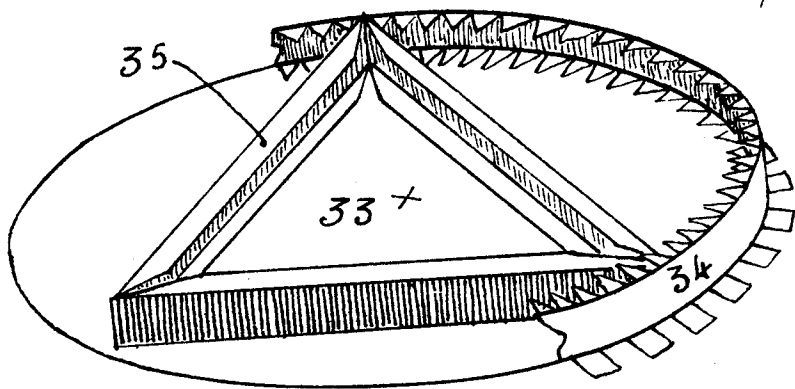

Fig. 5.

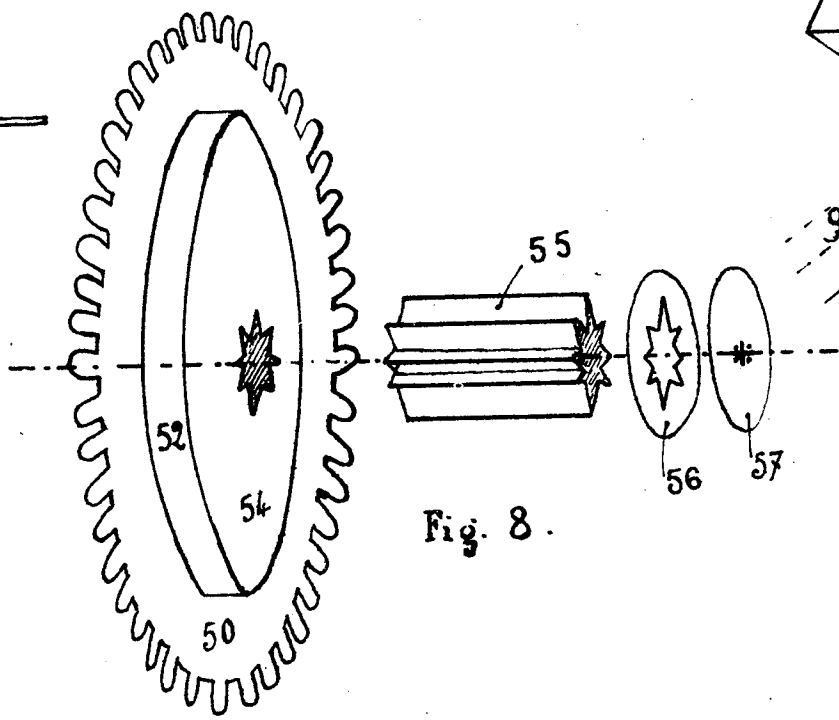

Fig. 8.

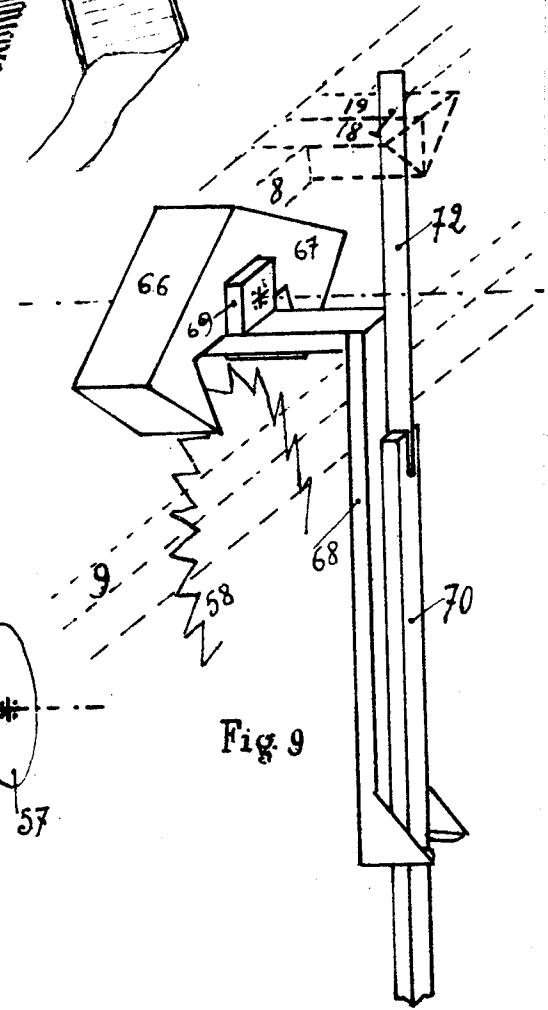
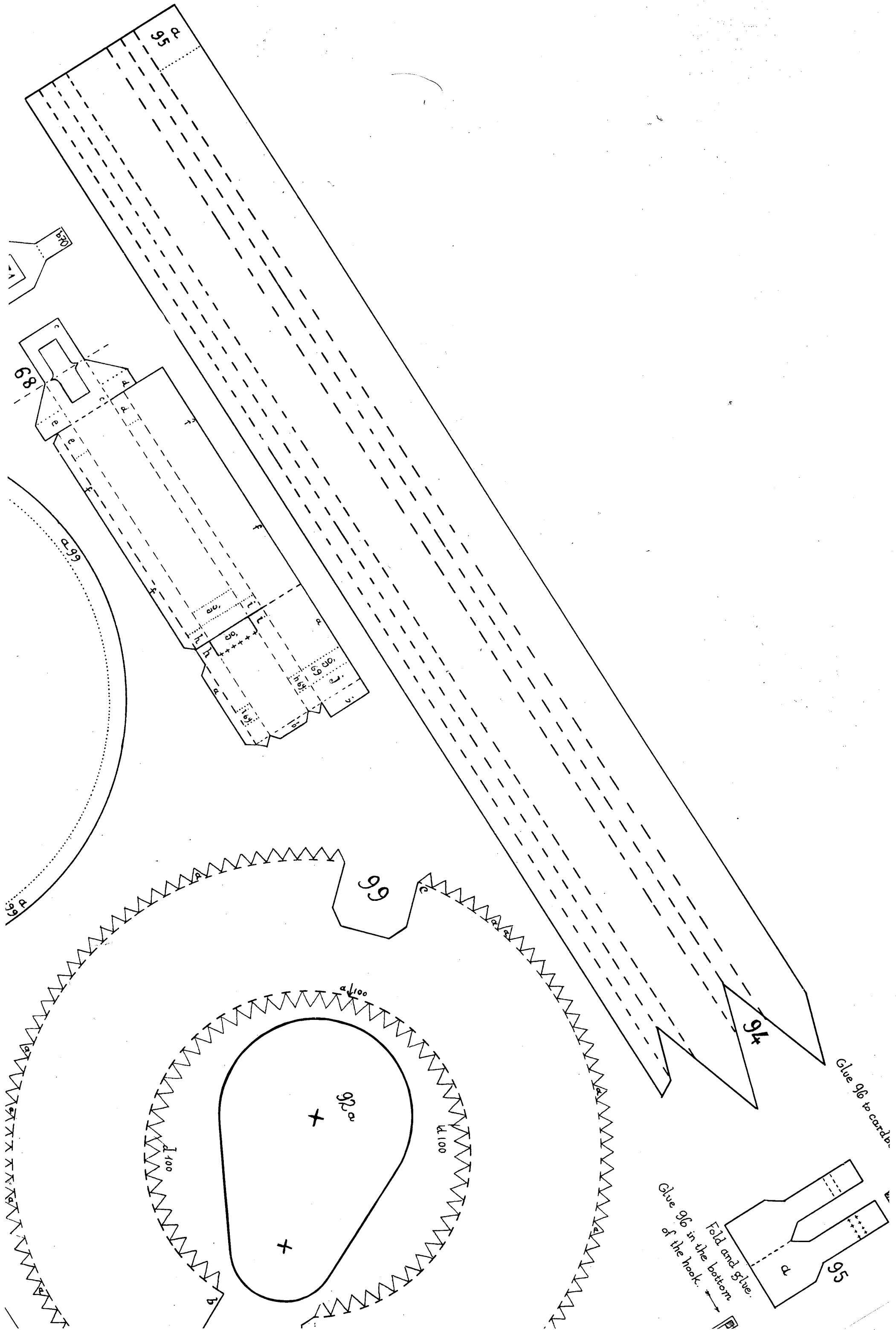
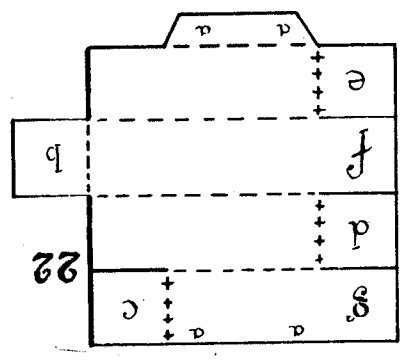
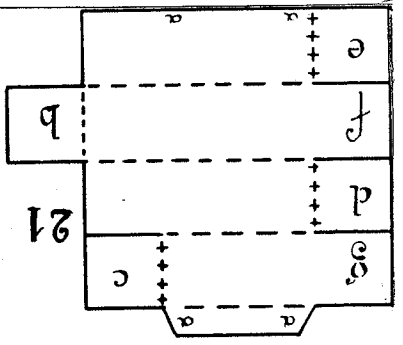
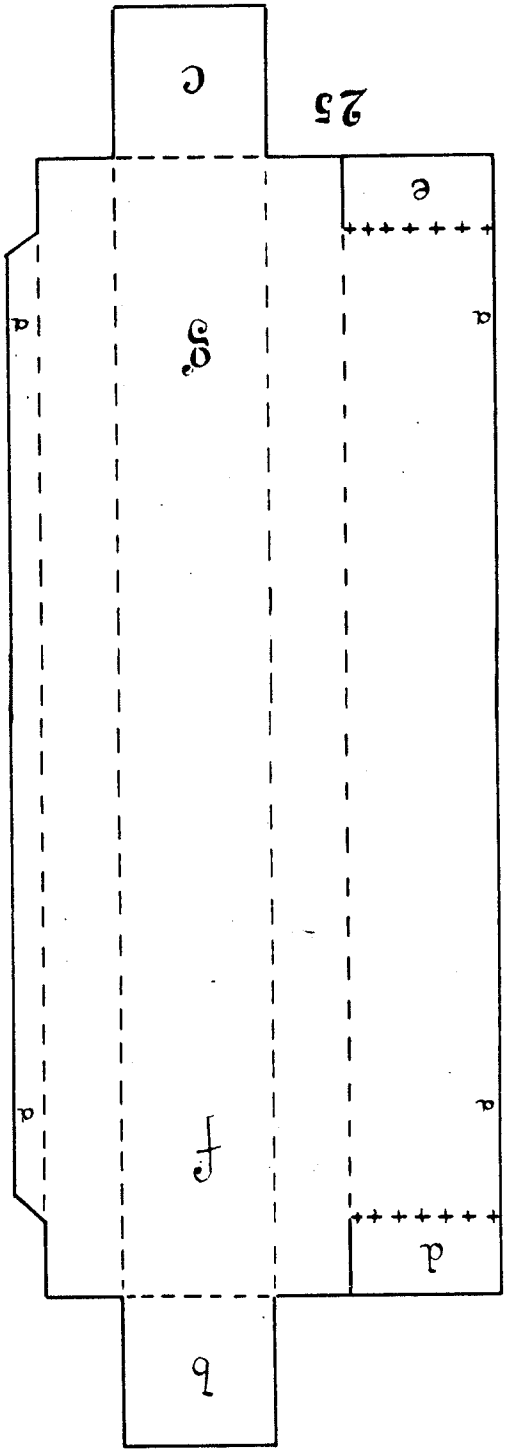
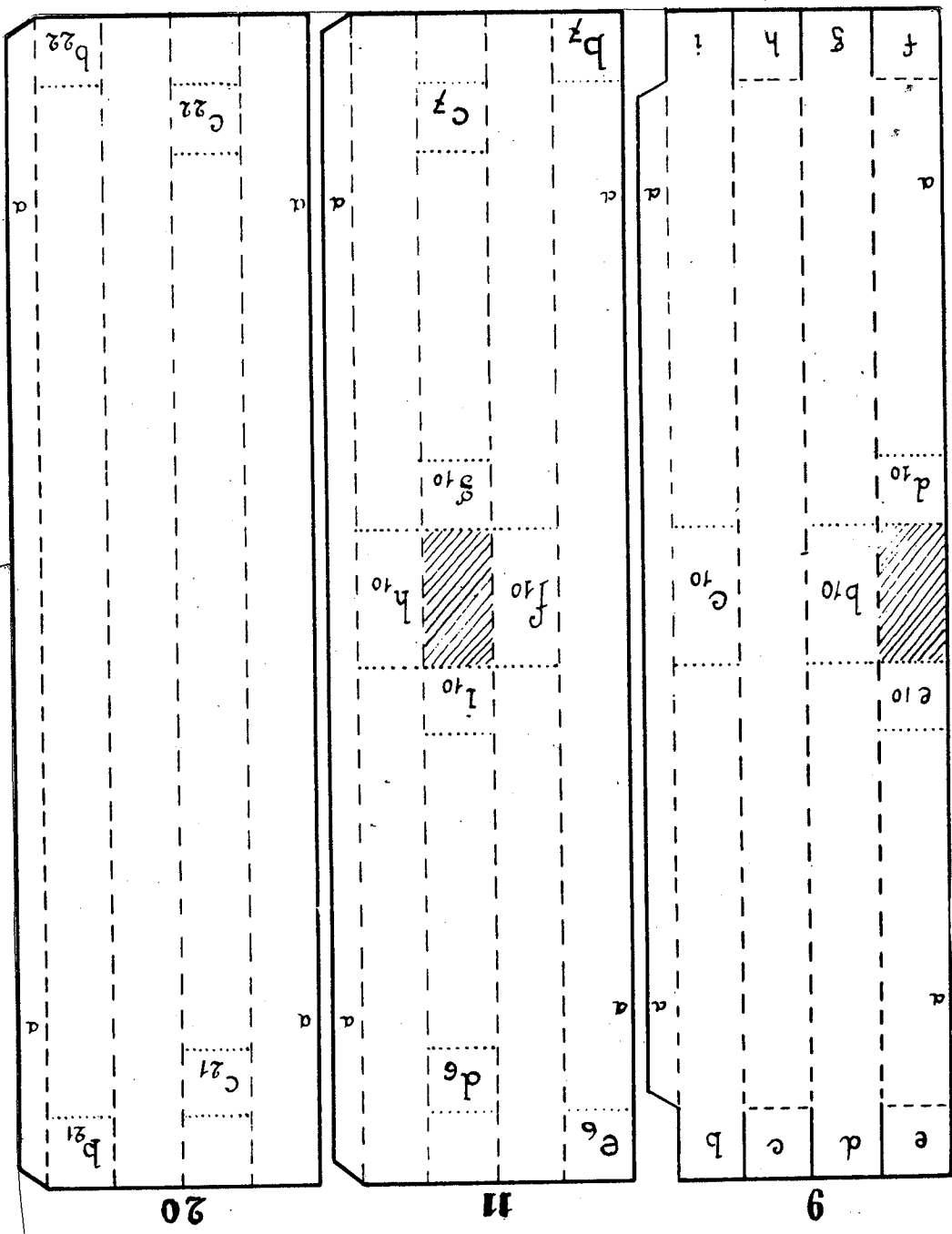
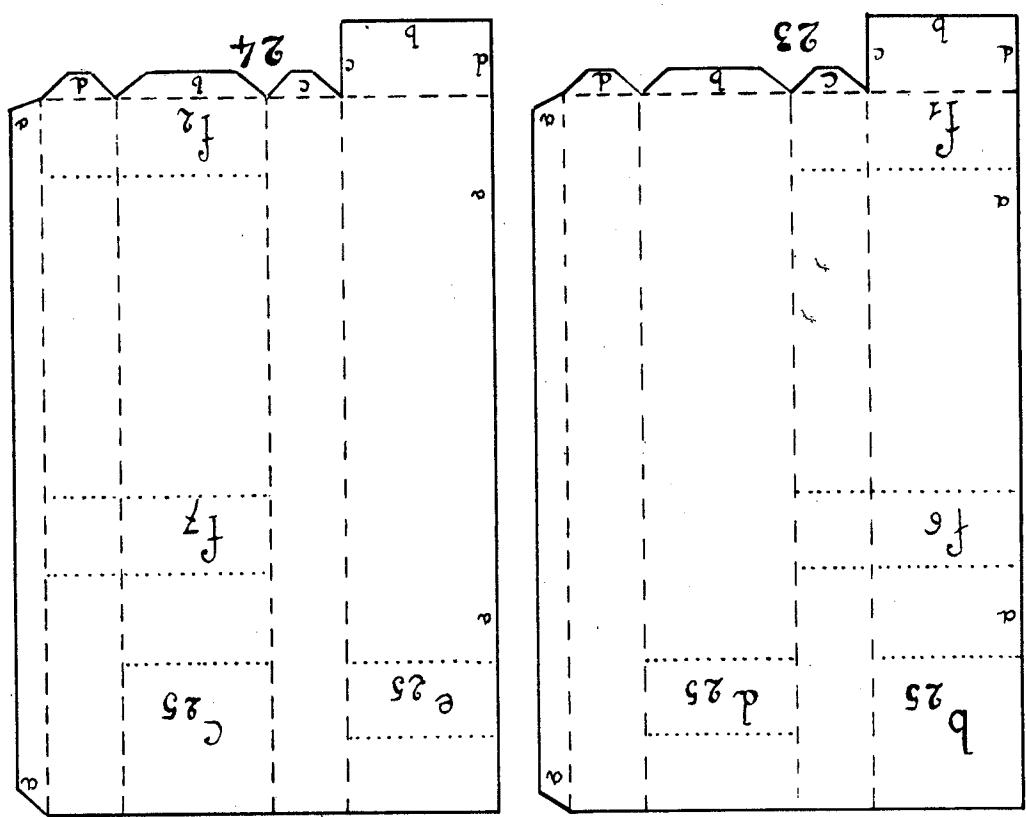
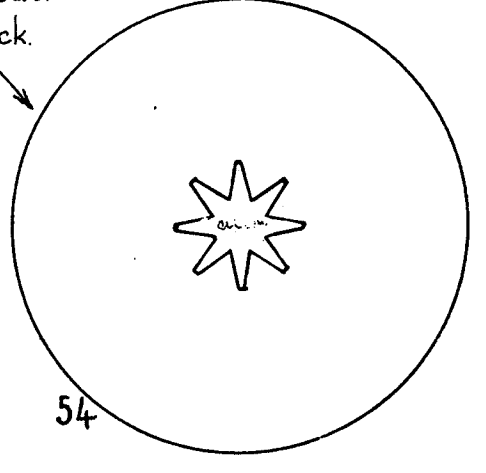
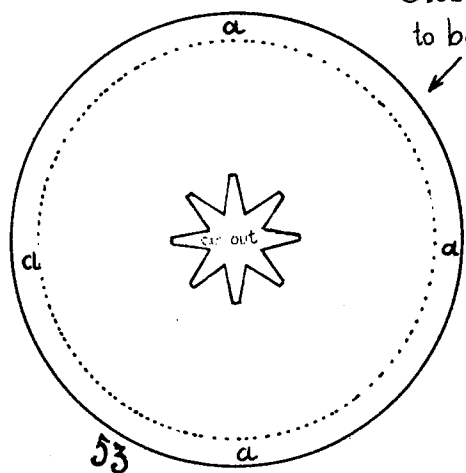
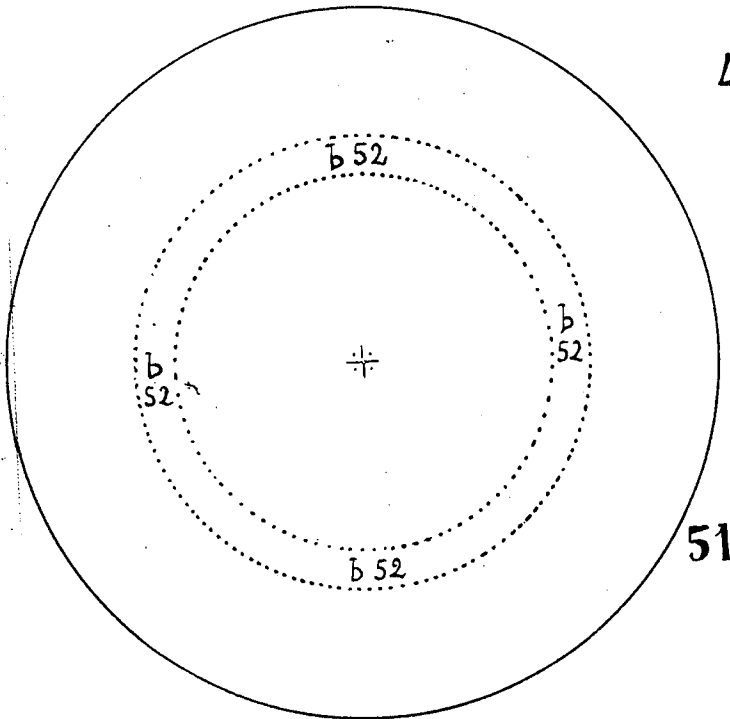
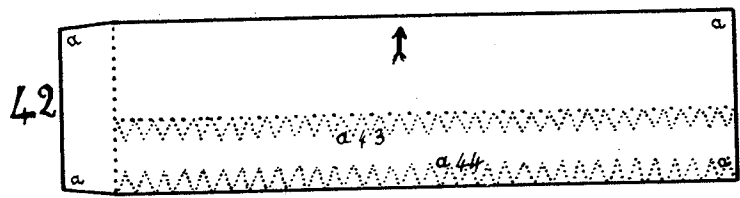
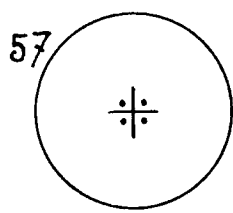
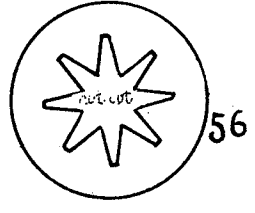
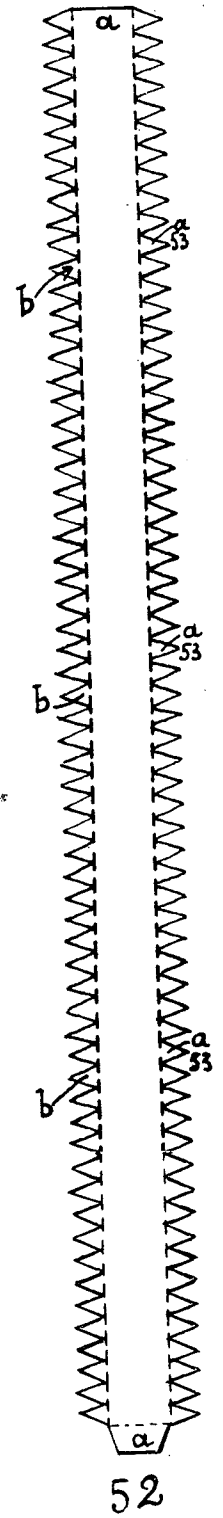
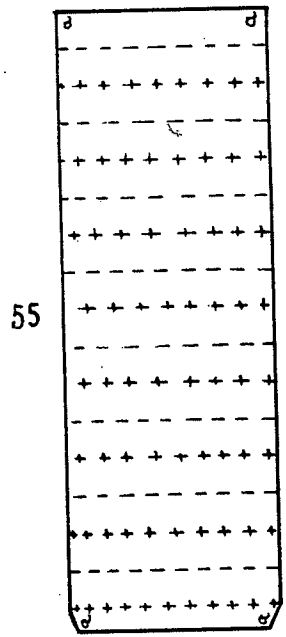
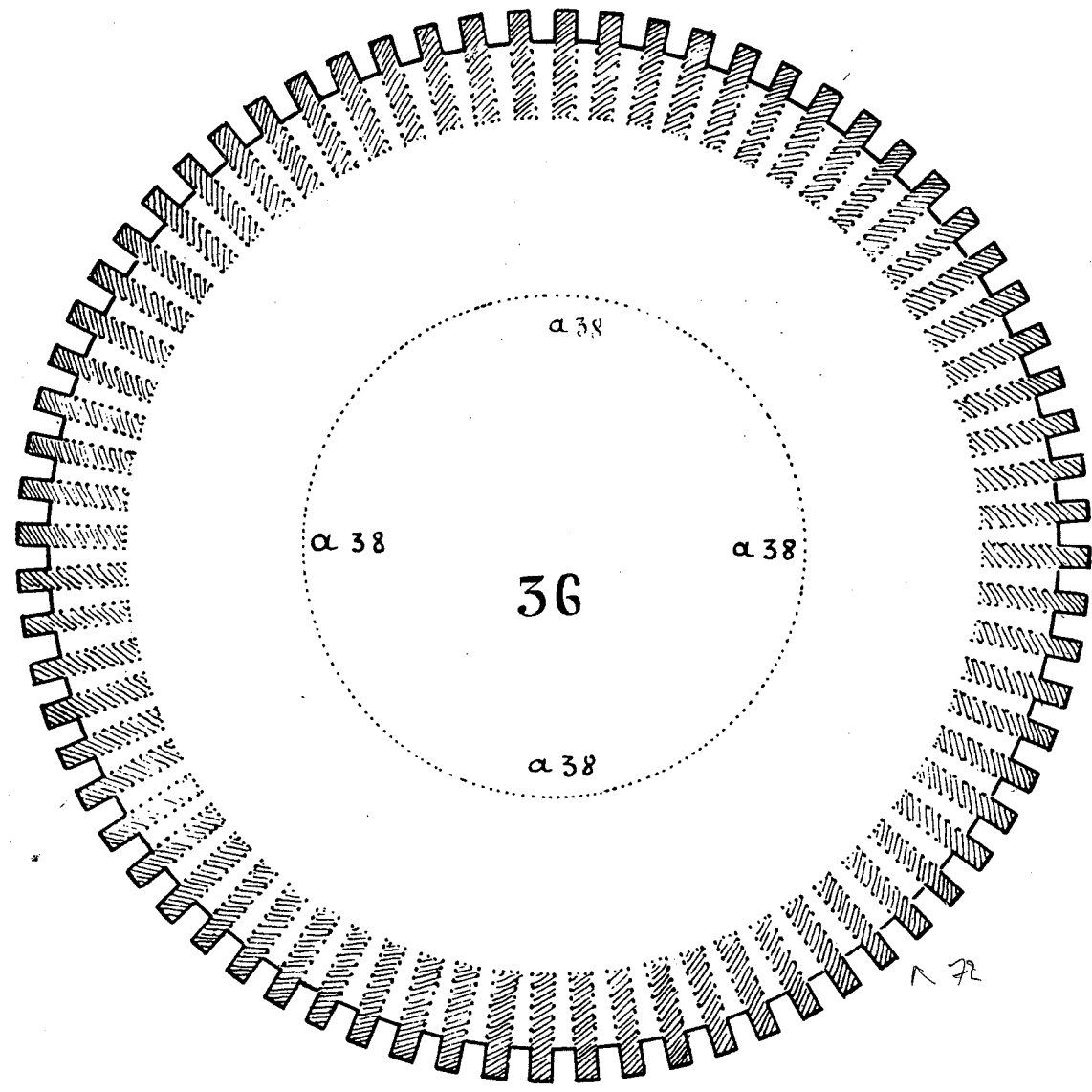
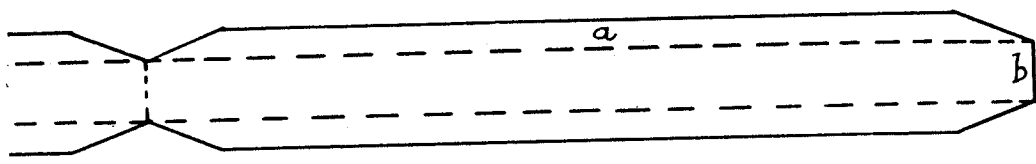
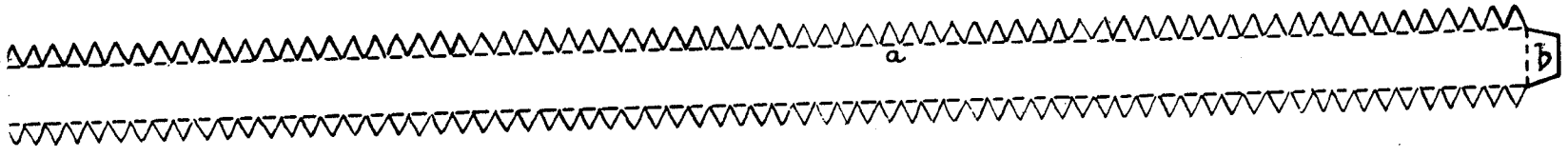

Fig. 9.







Glue back to back.

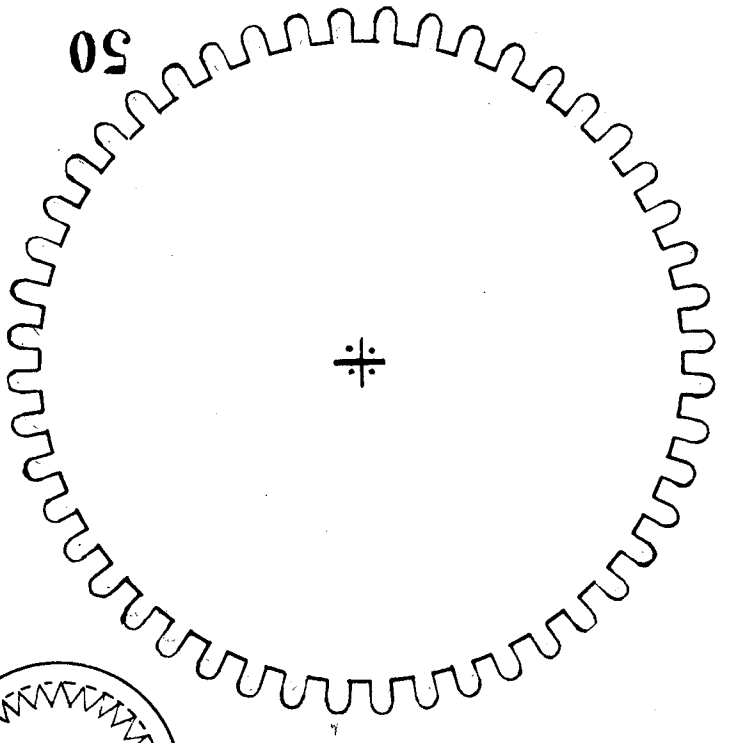
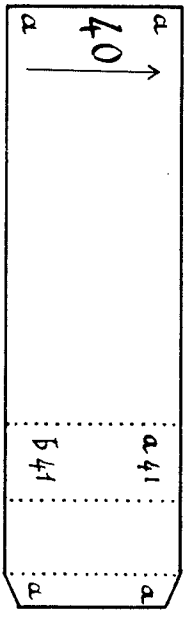
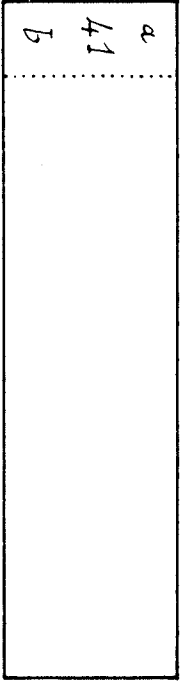
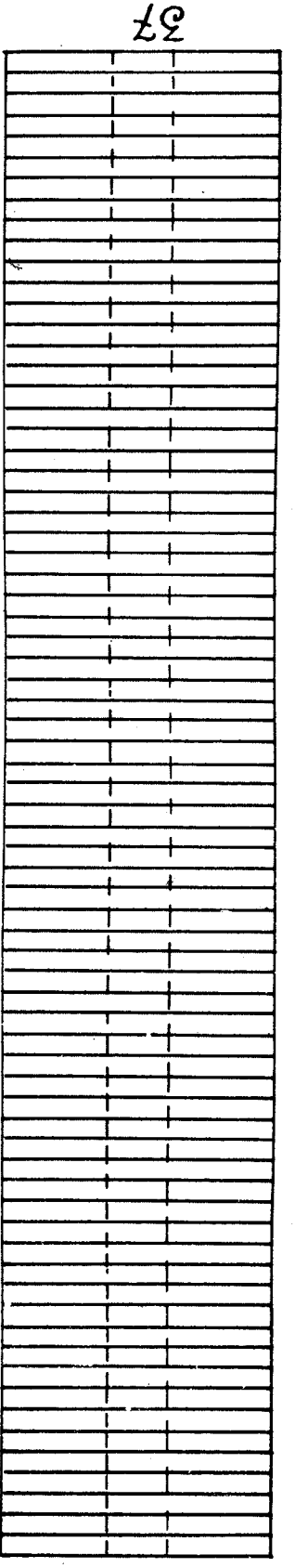

Glue 50 back to back with 51.

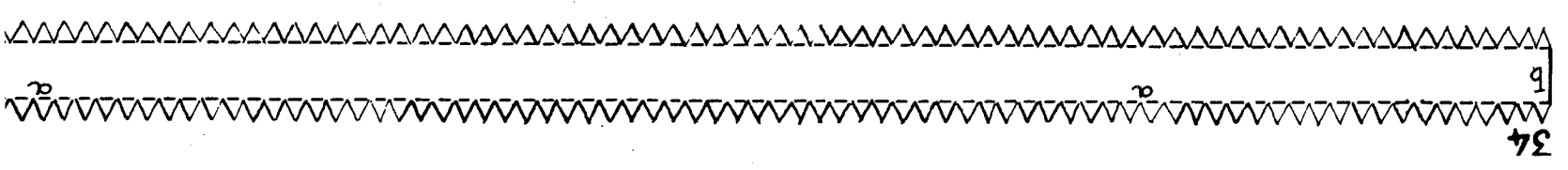
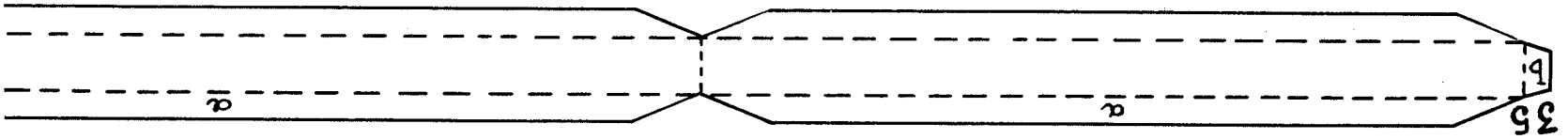
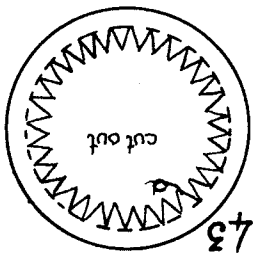
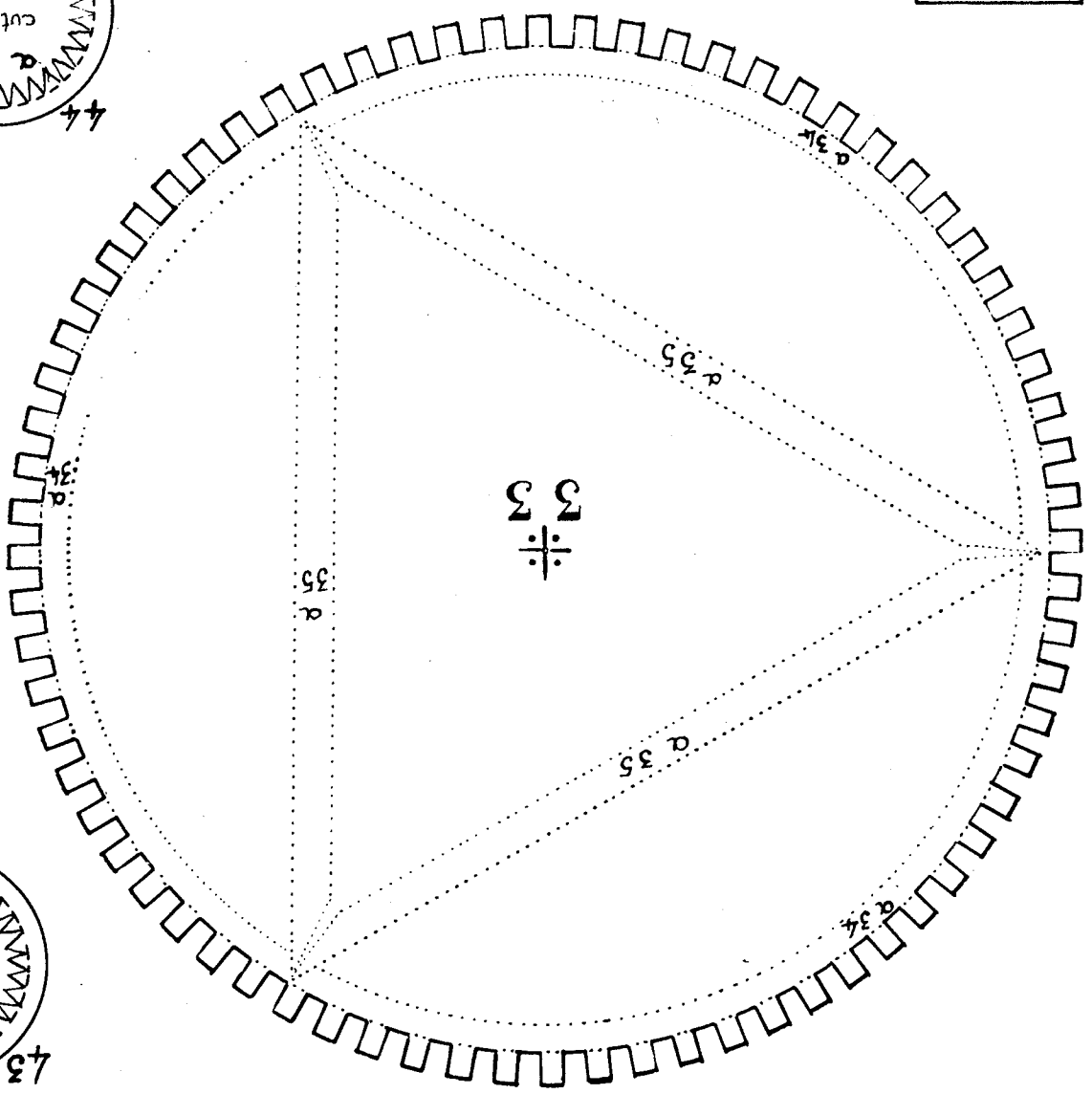
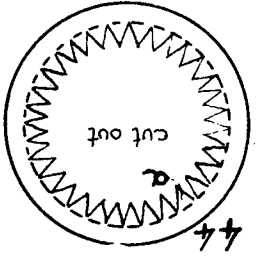

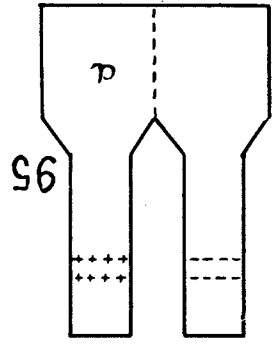
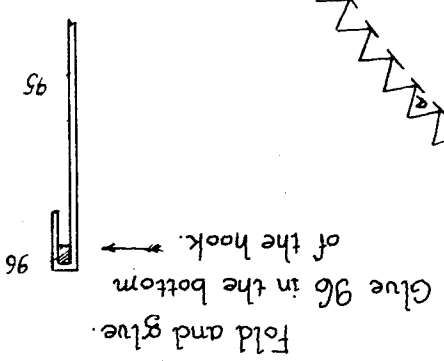
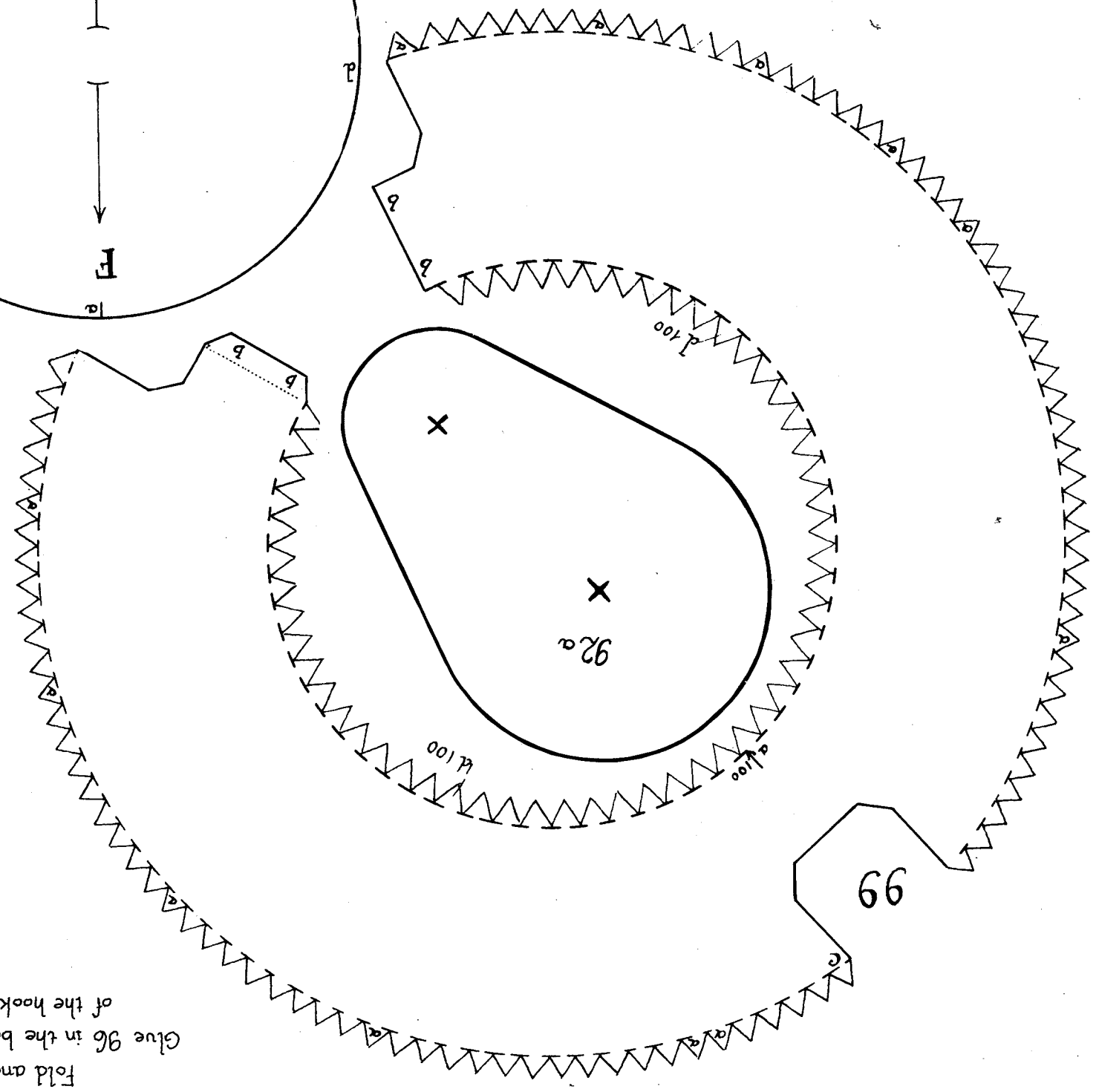
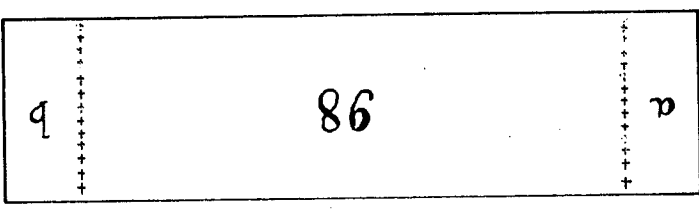
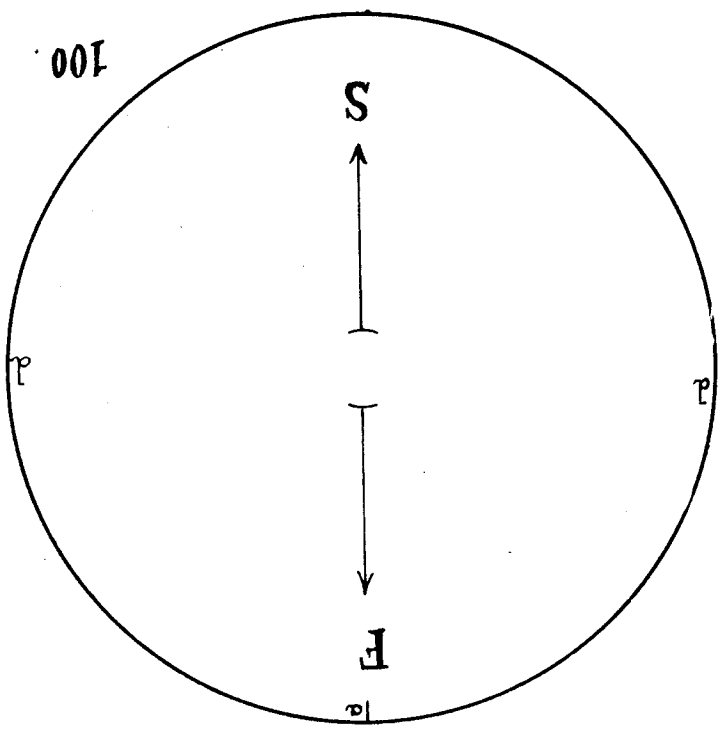

Glue 96 to cardboard 1 mm. thick

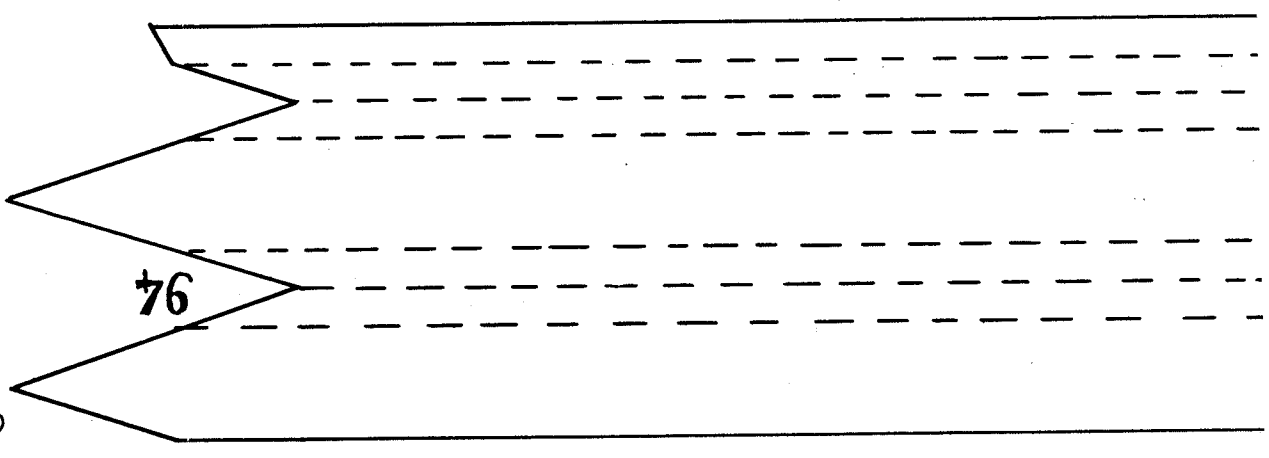

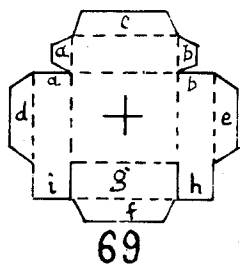
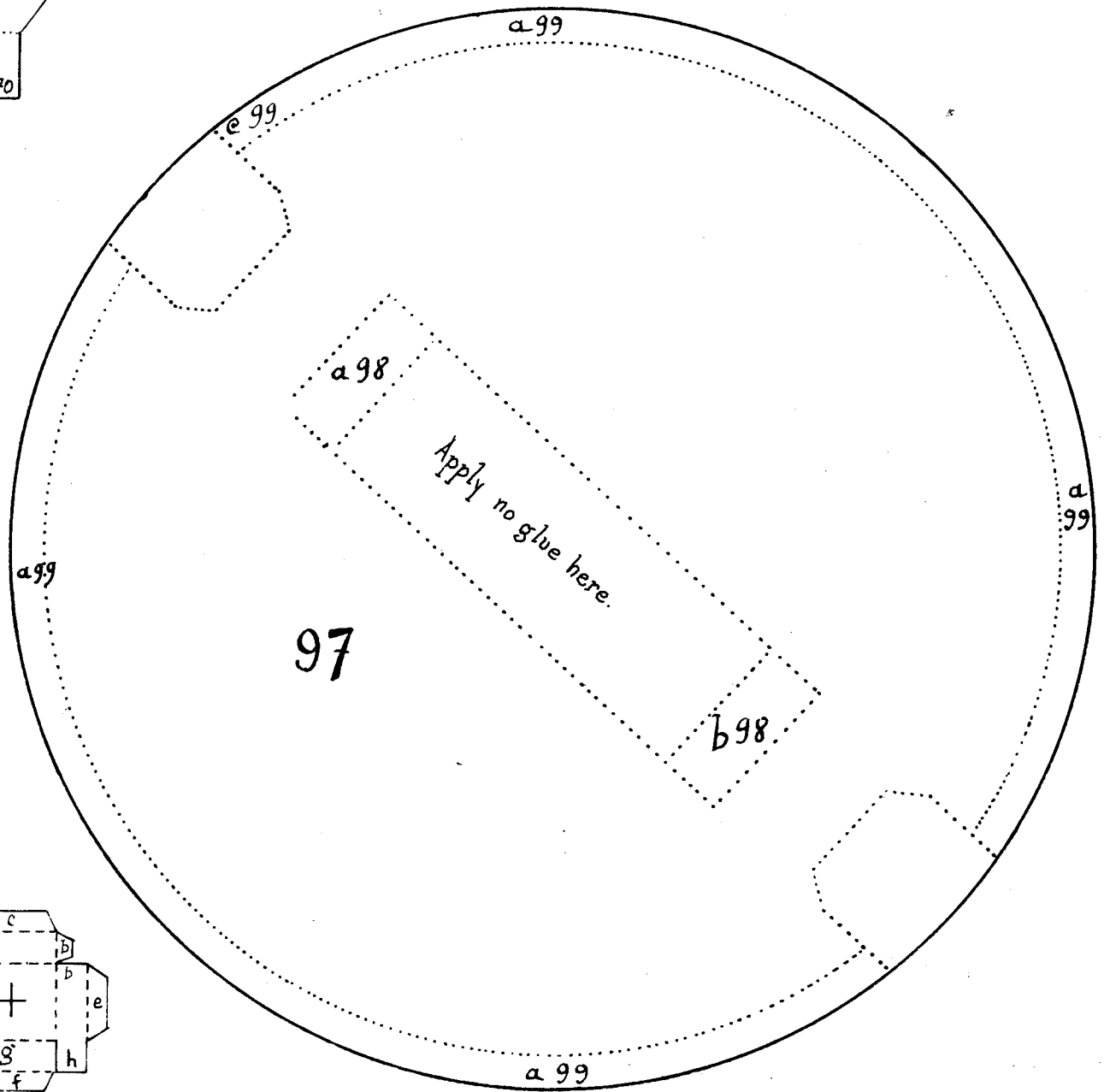
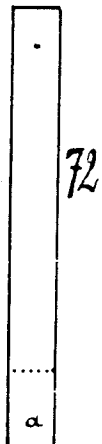
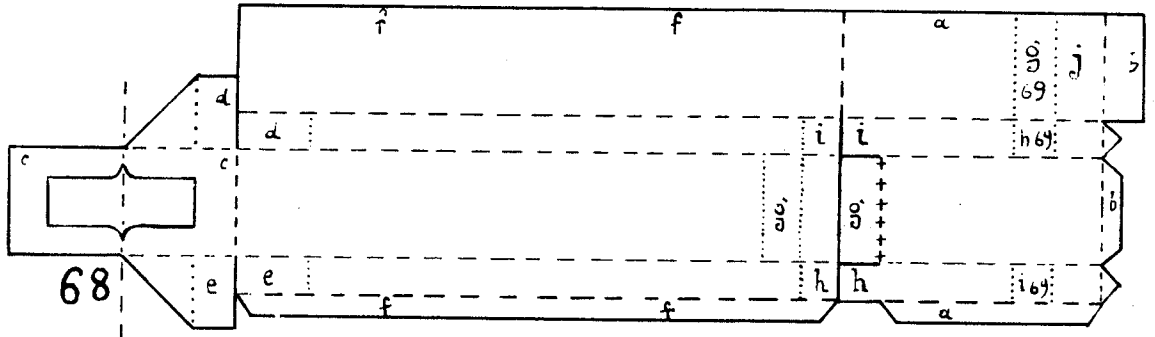
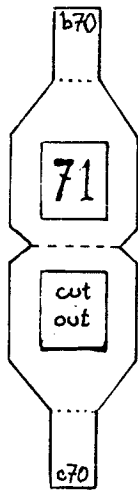
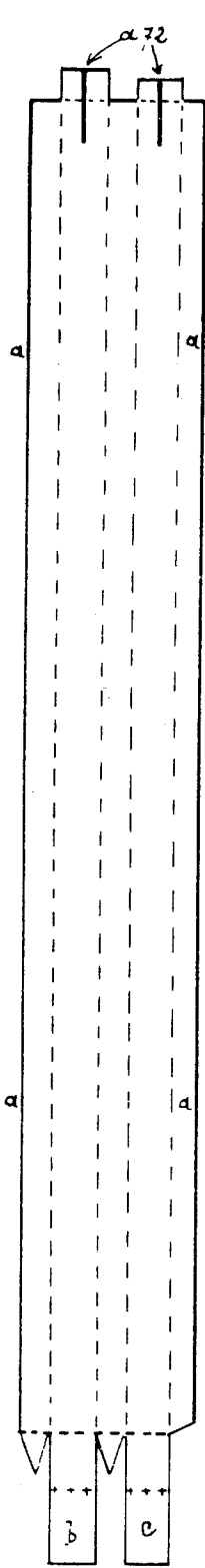
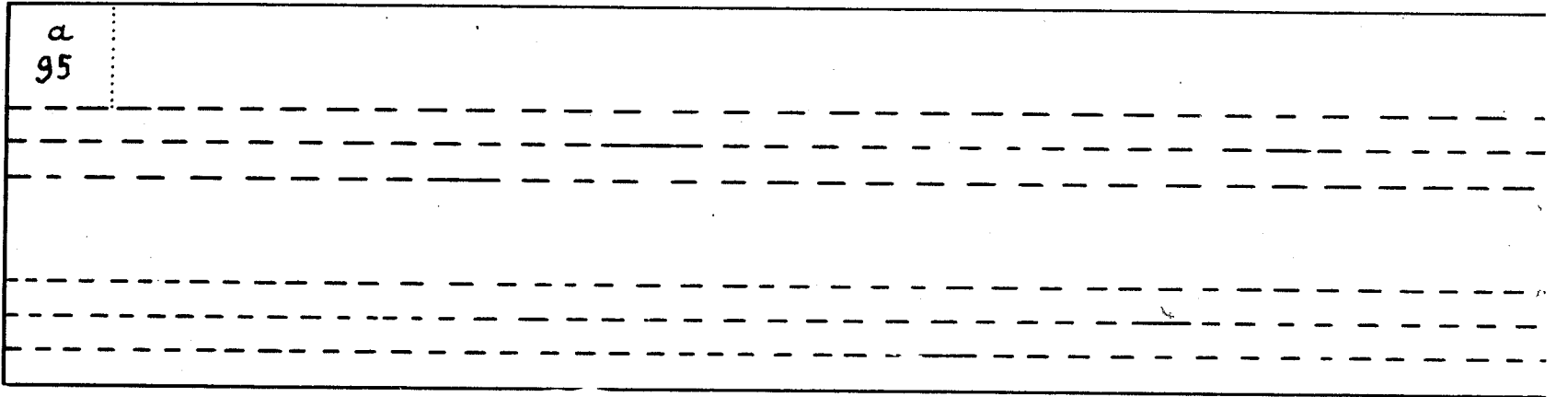

Fold piece 71 and glue between b and c of 70.

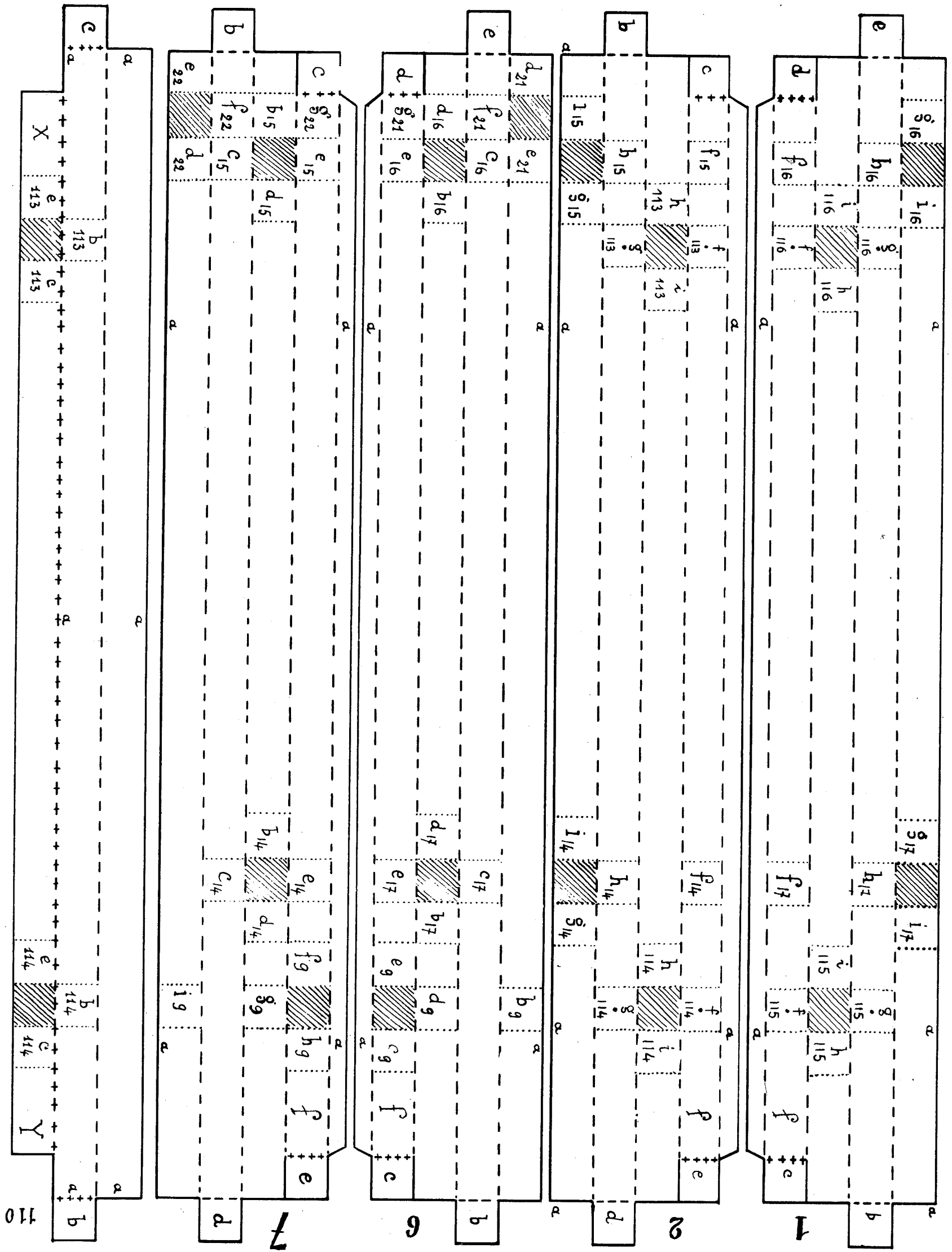

Metal wire going through the weight.



axle: wheel 81, 84
axle: motor wheel 50, 58
axle for the hands

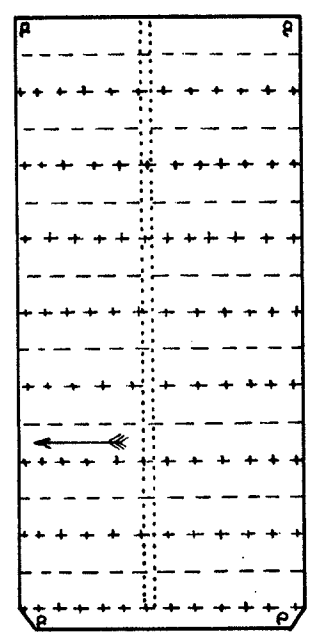
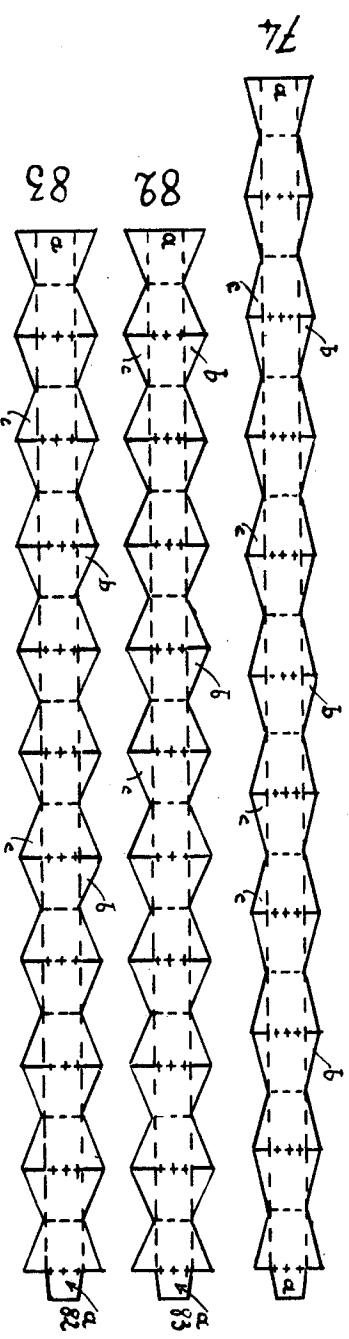
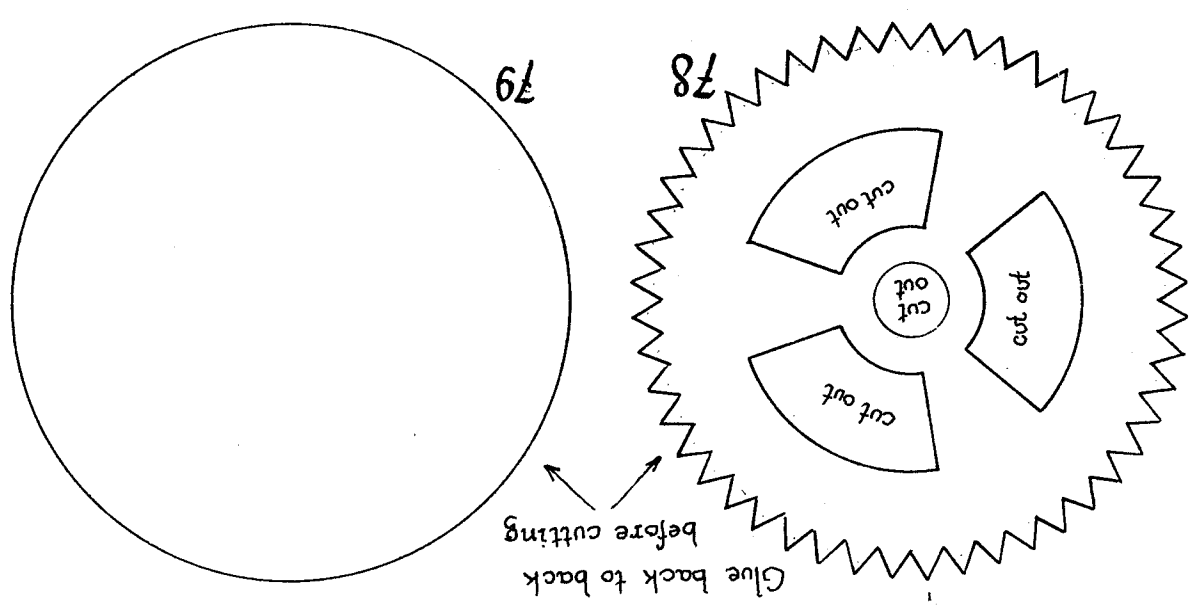
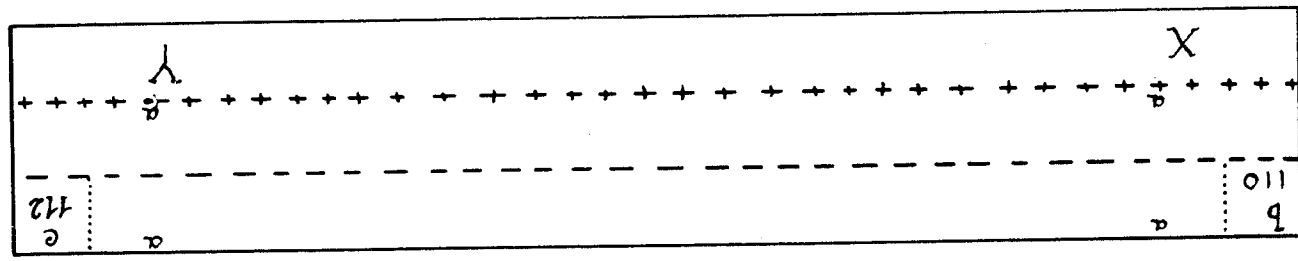
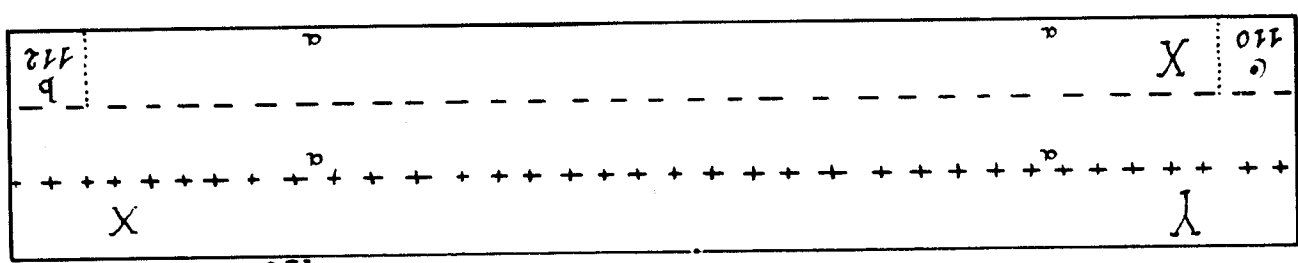
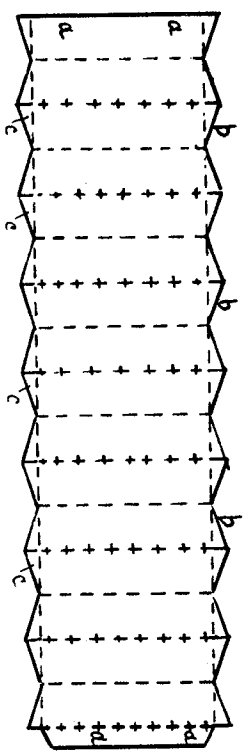
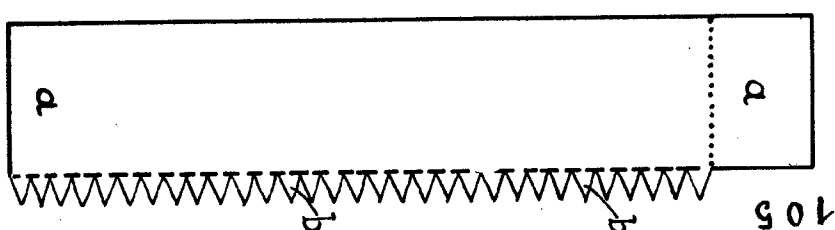
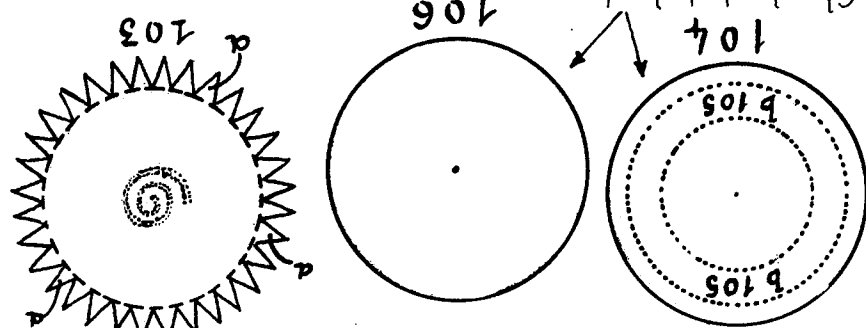
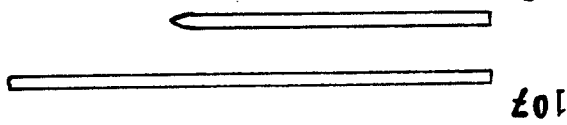

101

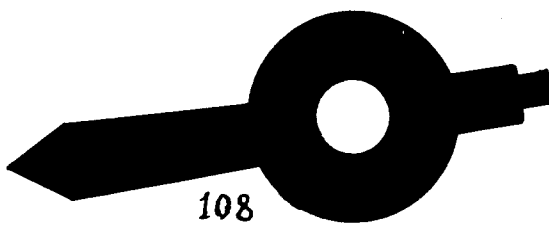
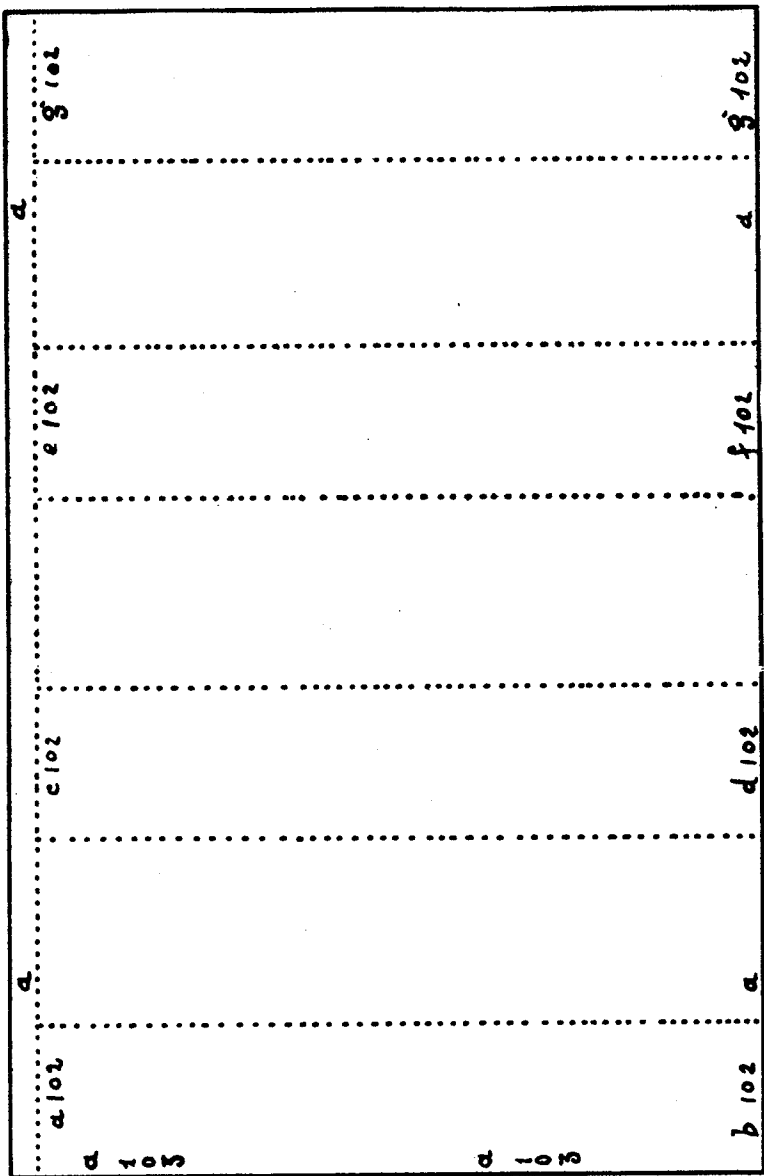

108

Glue on heavy cardboard.

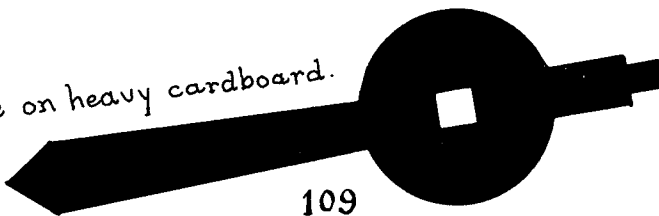

109

102

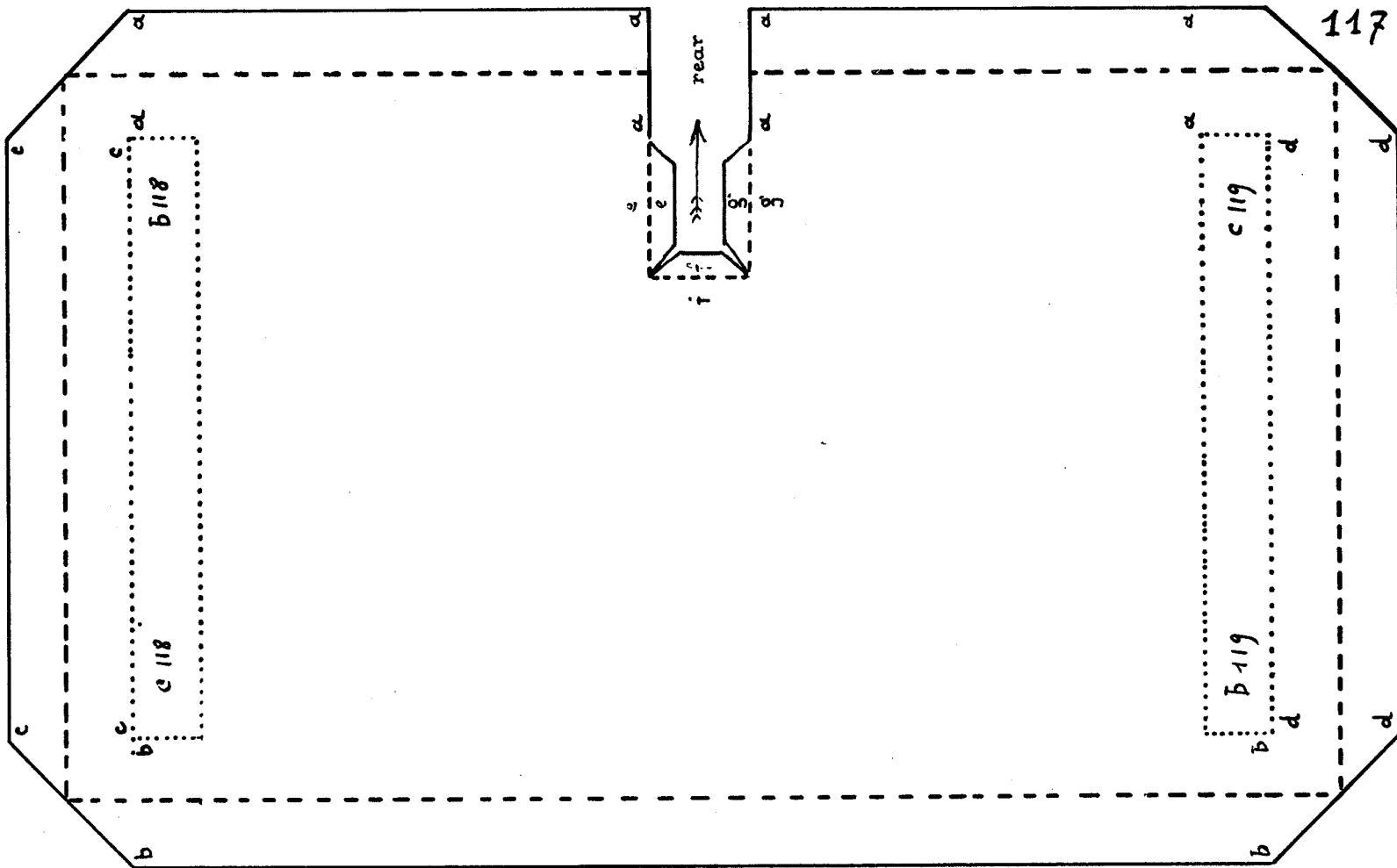
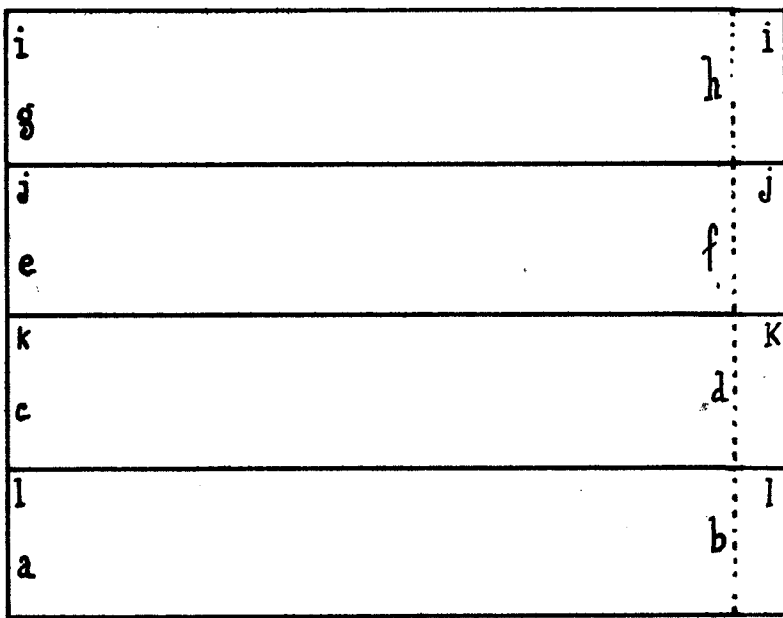

117

119

Glue to b119 and c119, but on the underside of piece 117

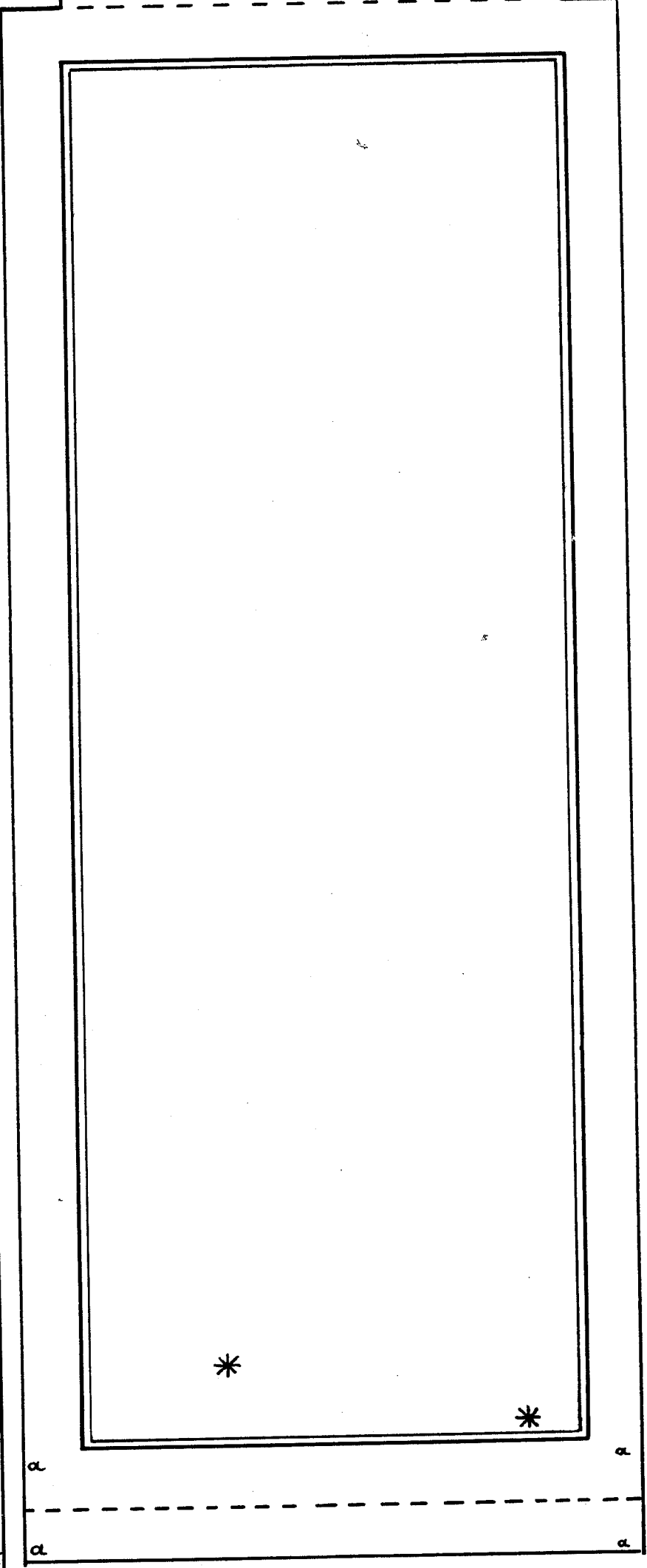

118

Glue to b118 and c118 but on the underside of piece 117

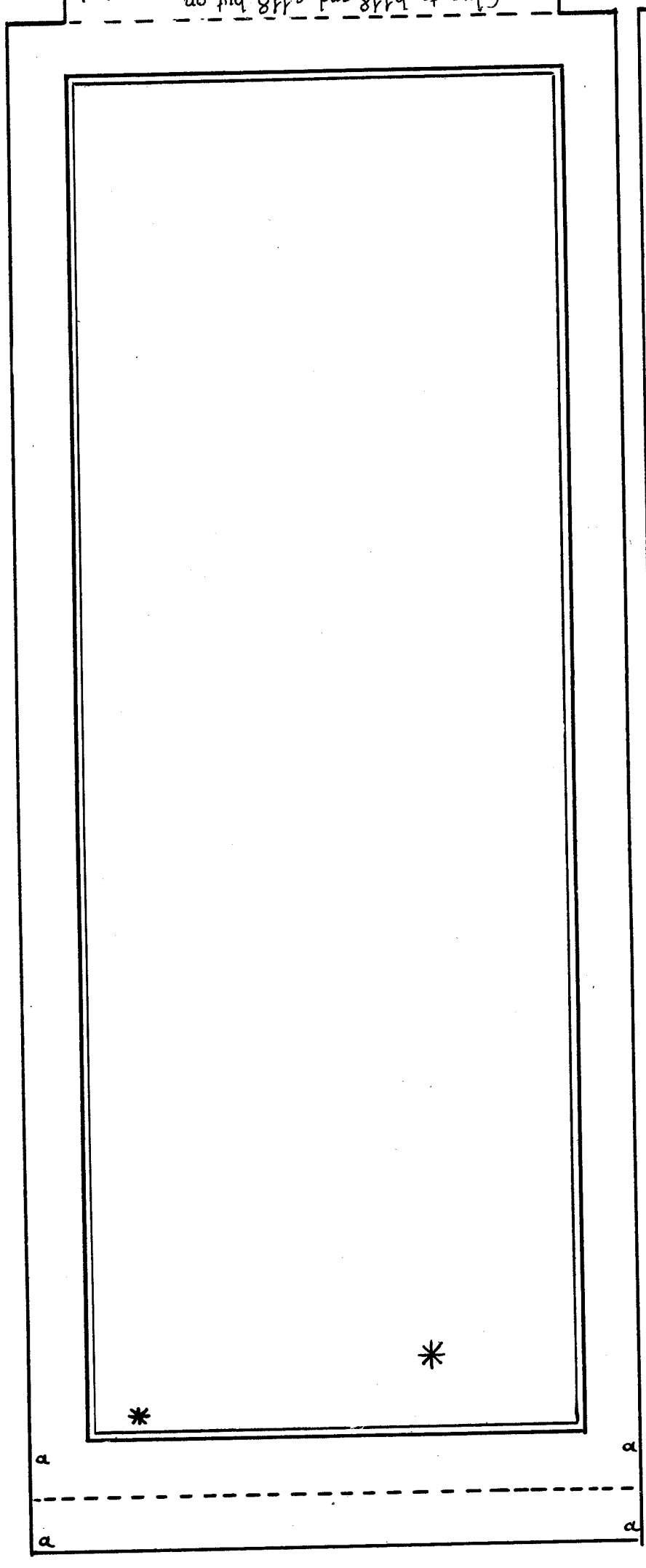

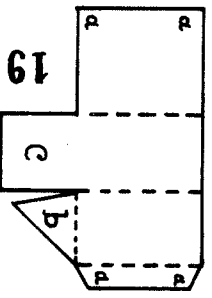
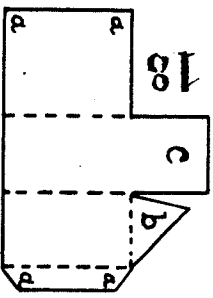
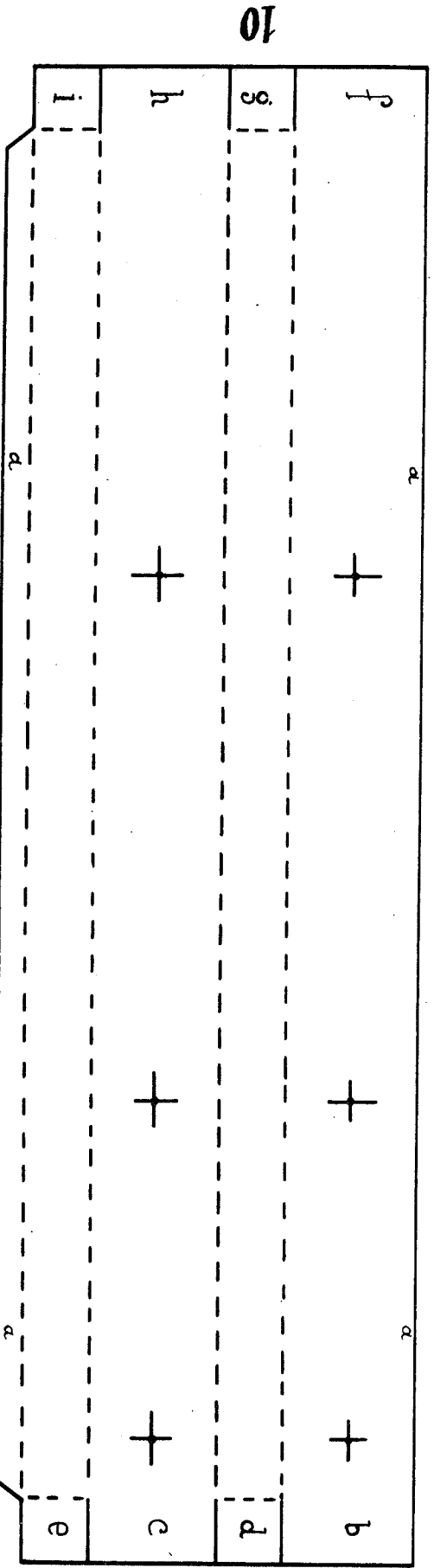
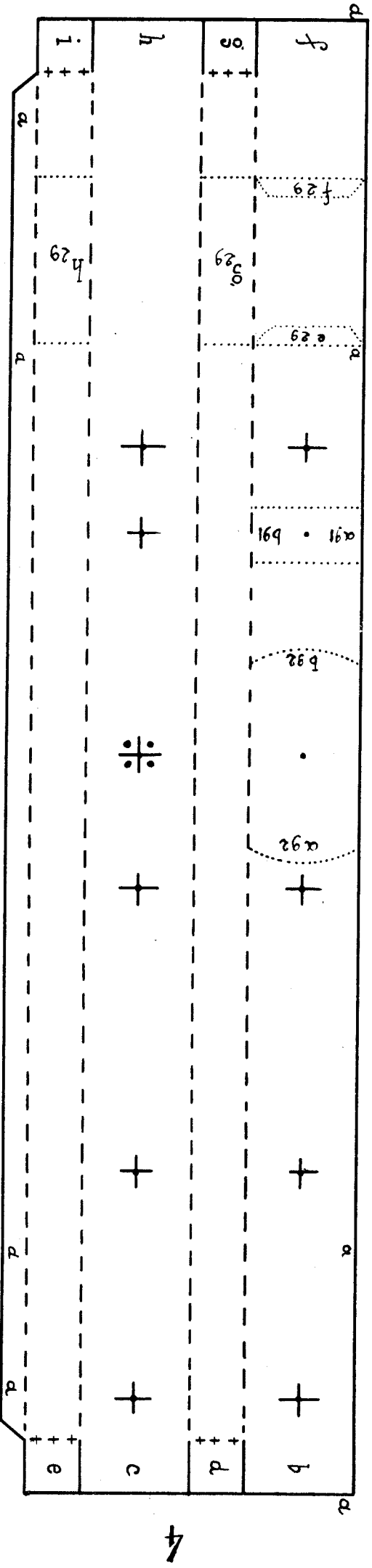
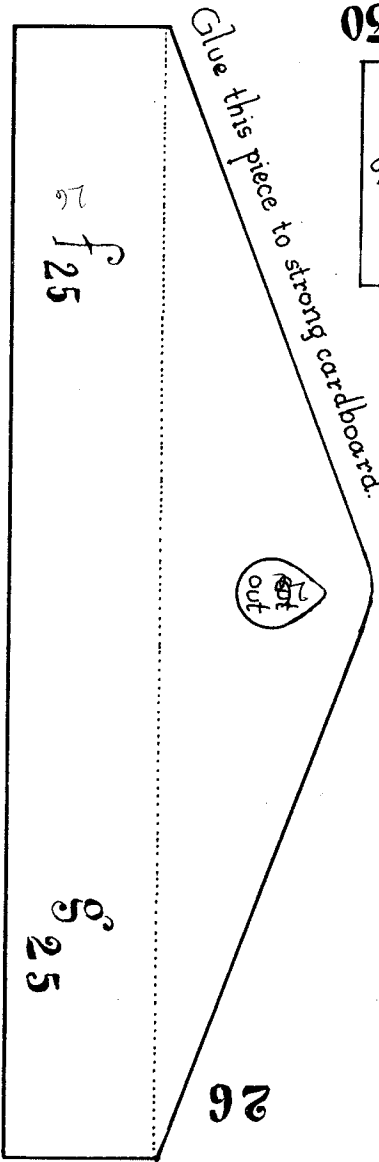
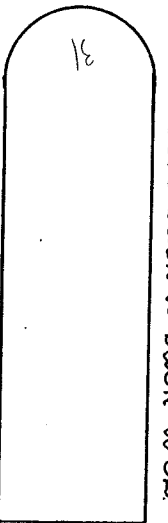
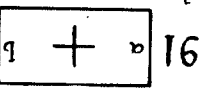
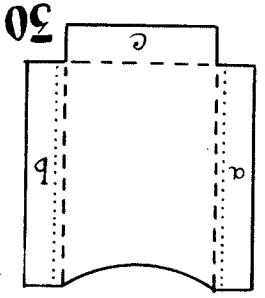
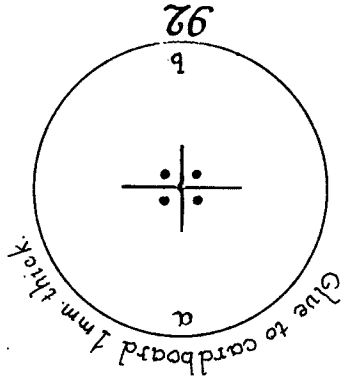
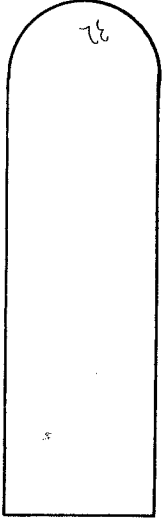
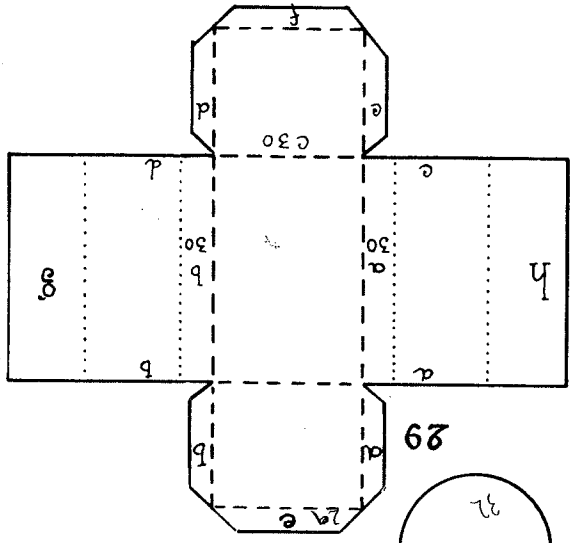

Glue 58 back to 59 before cutting.

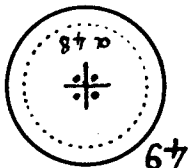
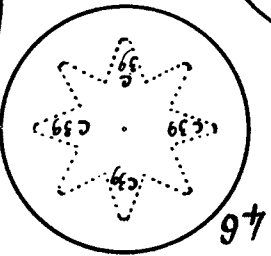
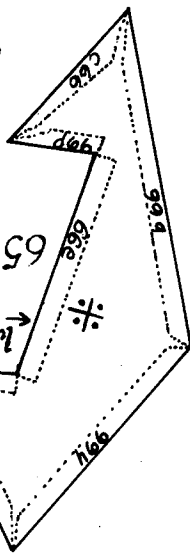
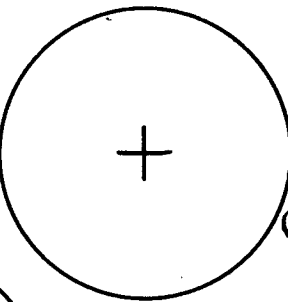
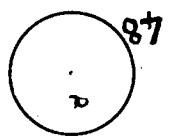
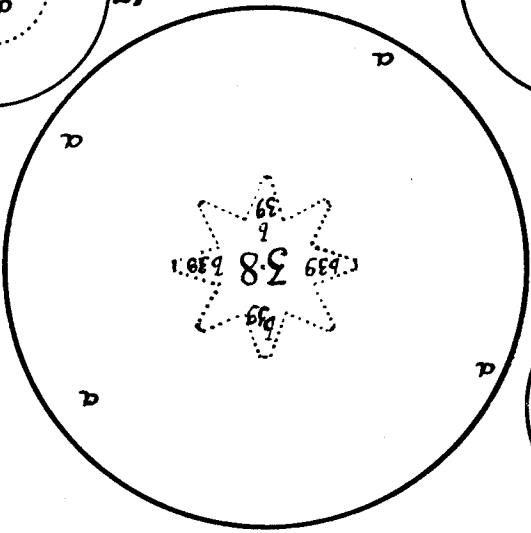
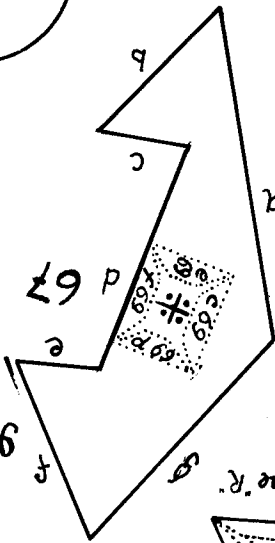
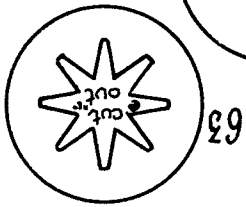
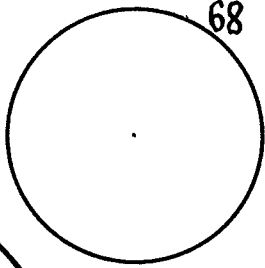
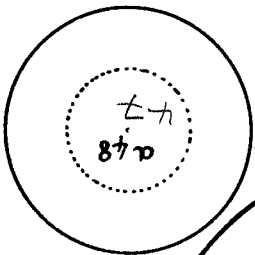
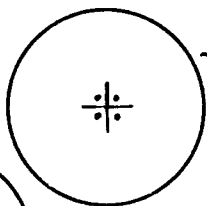
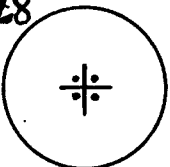
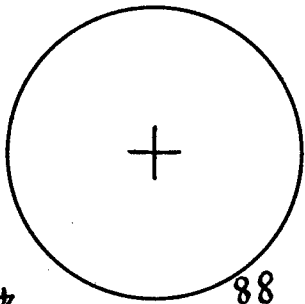
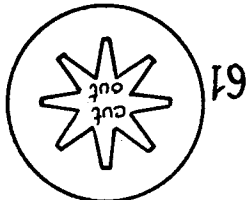
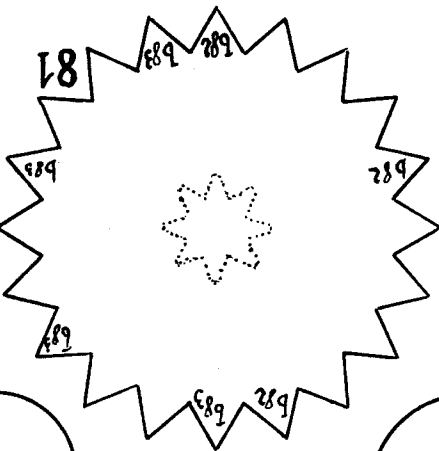
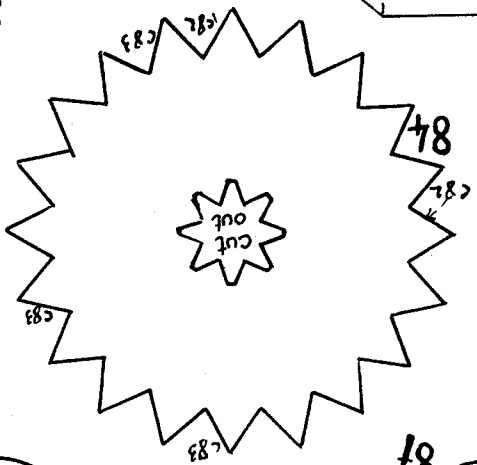
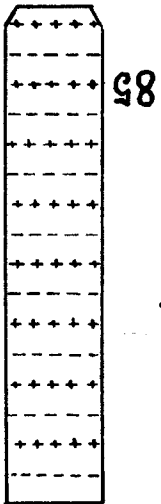
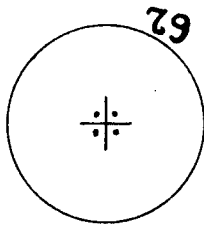
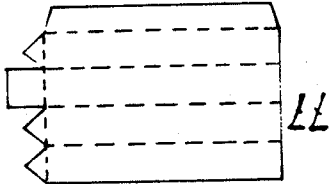
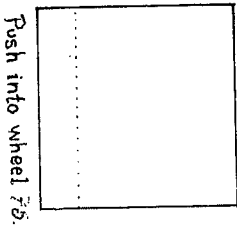
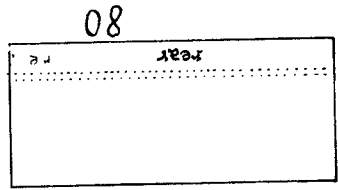
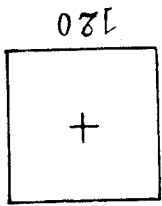
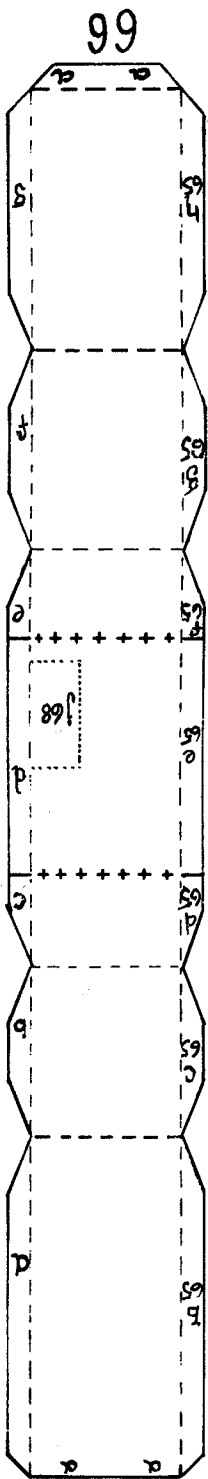
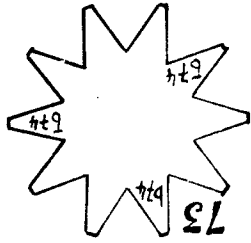
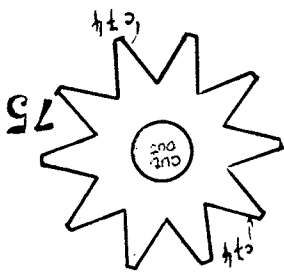
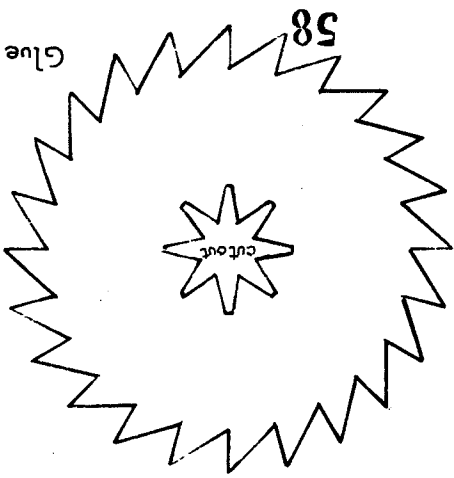
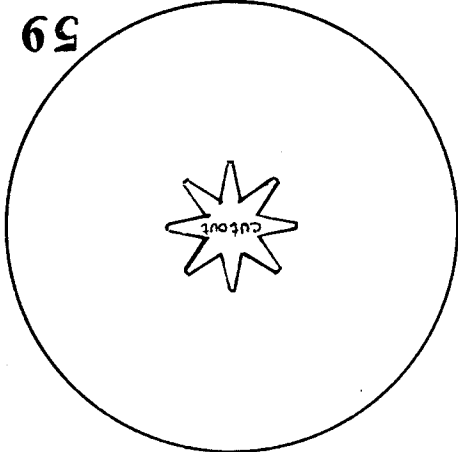

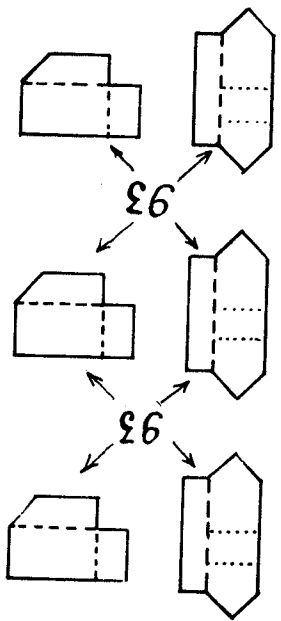
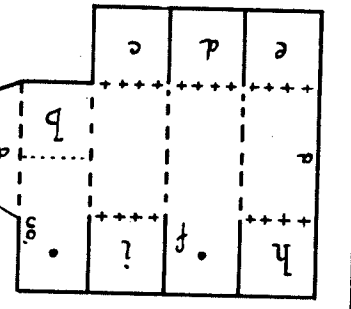
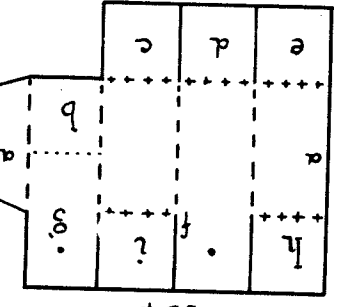
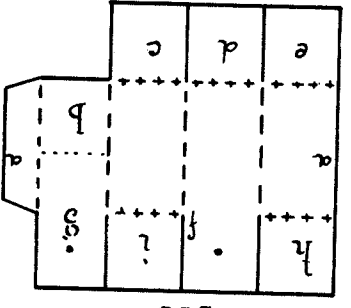
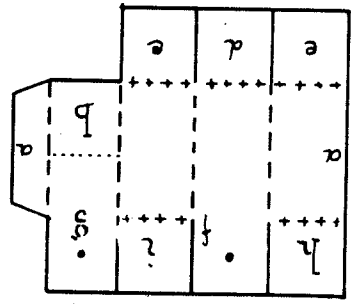
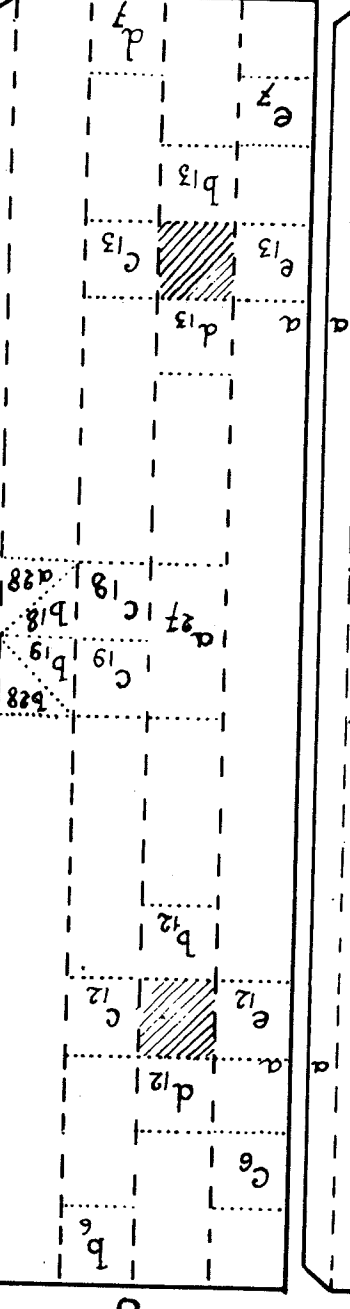
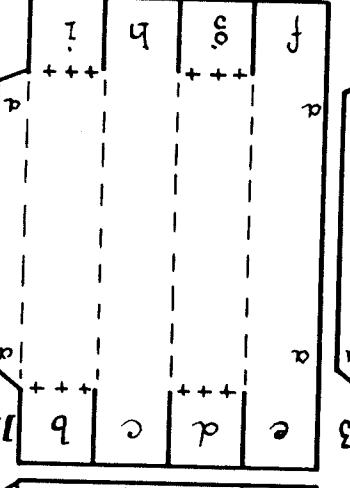
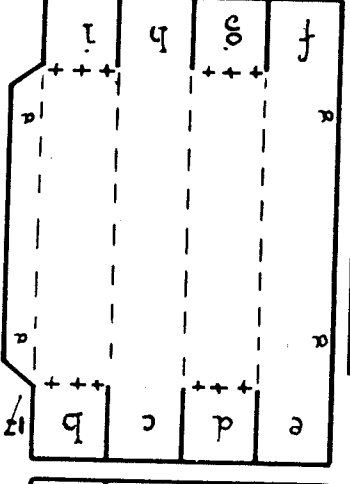
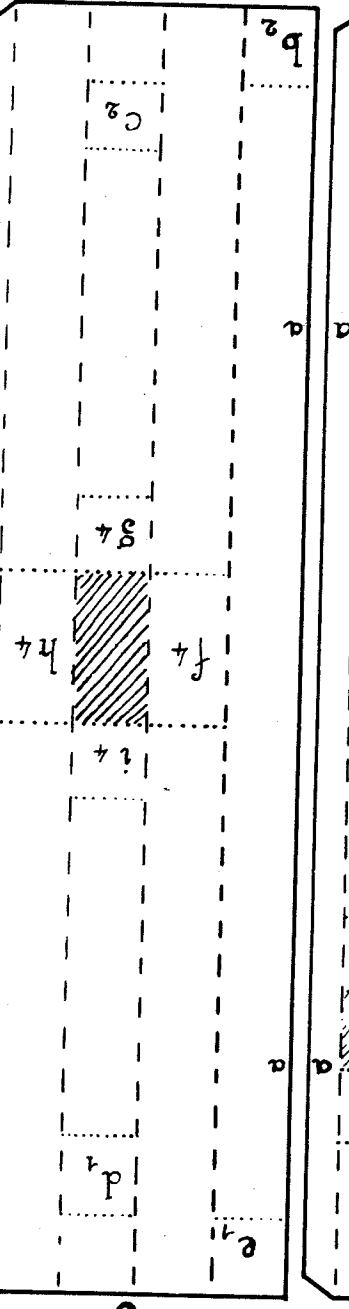
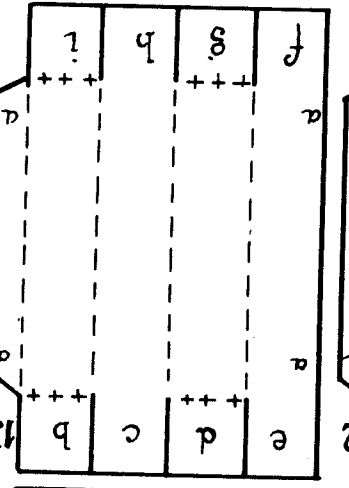
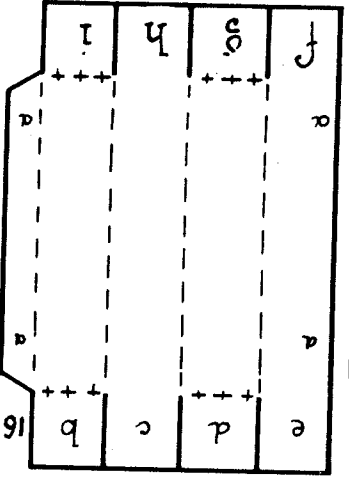
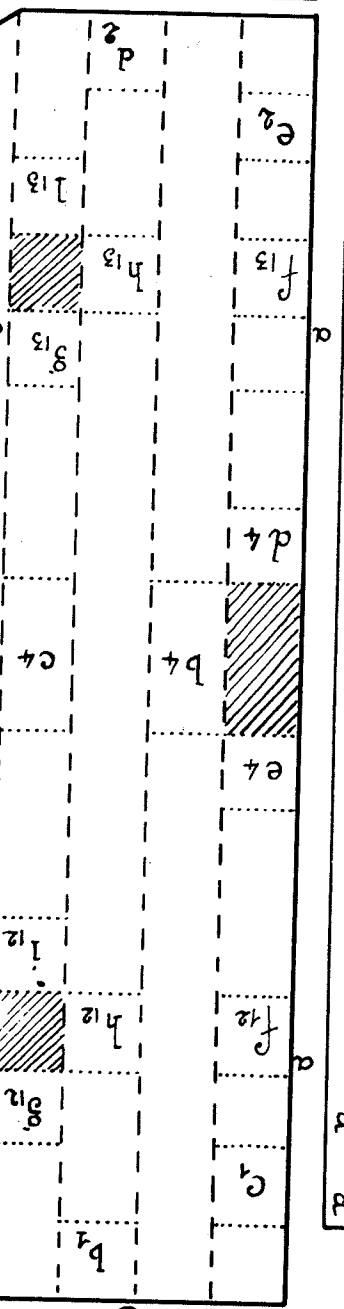
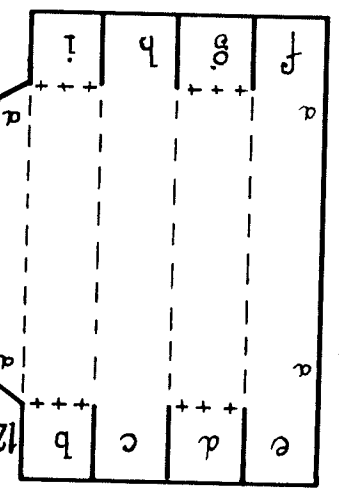
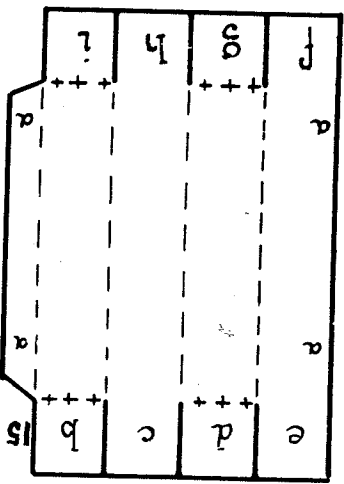
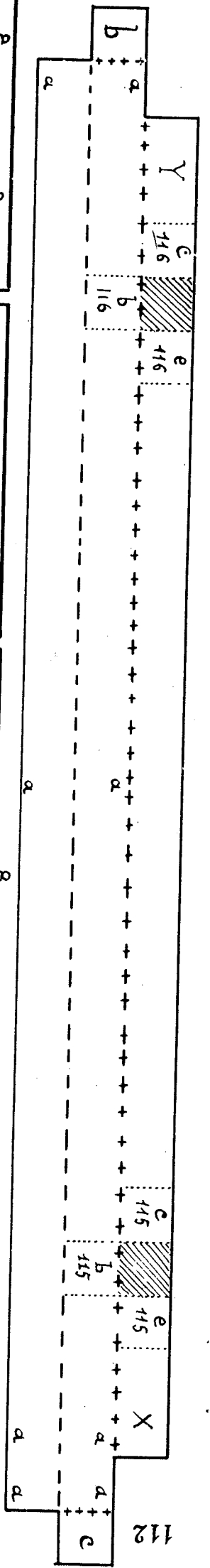

93

8

5

3

112

116

115

114

113

116

116

115

115

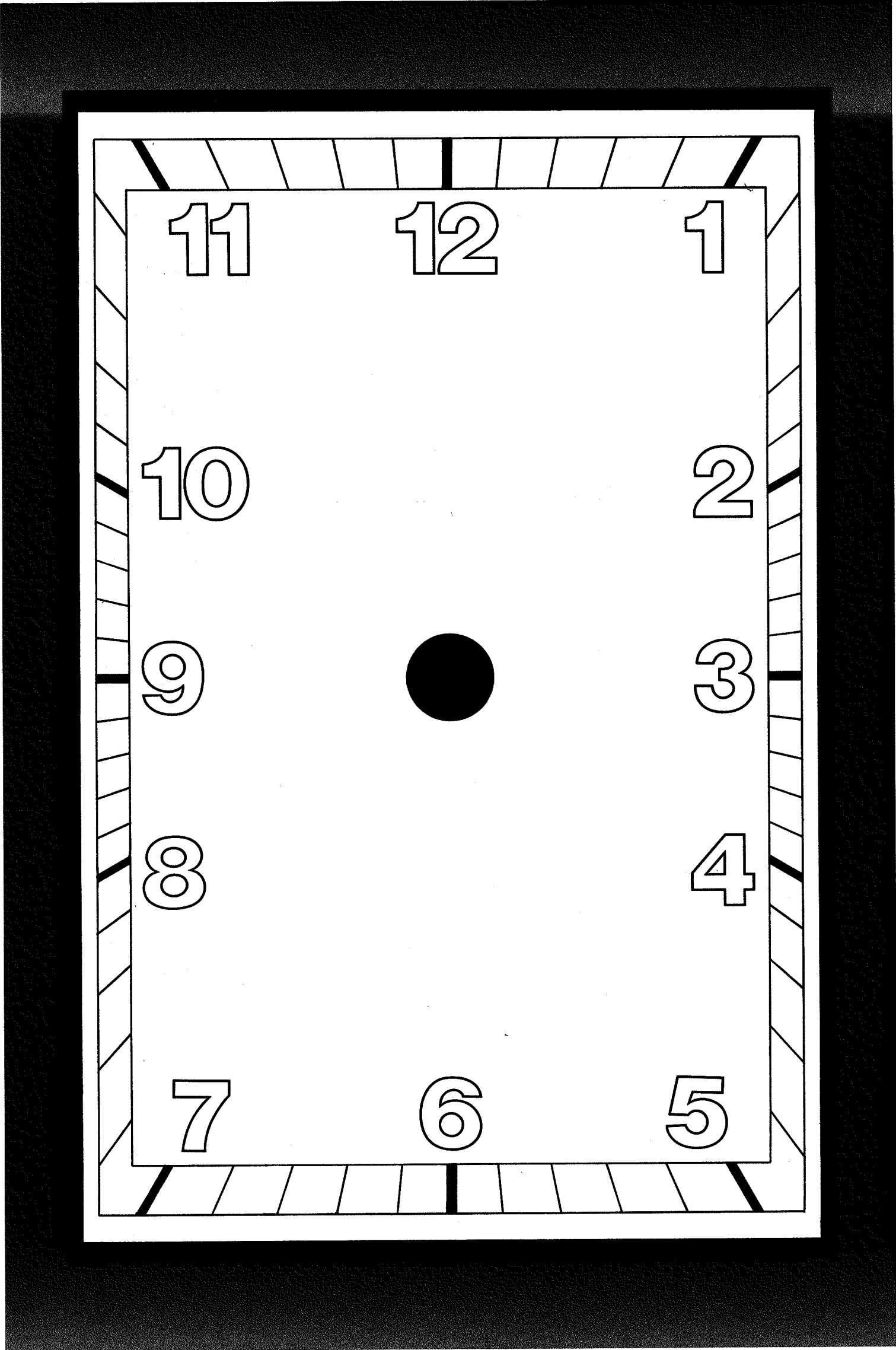

11

12

1

10

2

9

3

8

4

7

6

5

Instructions for Assembly

Cutting and assembly of this construction require great care and patience. Do not try to work too fast. Follow exactly the detailed instructions below and you will be rewarded with a paper clock that actually works and that will tell the time as precisely as your wristwatch.

I. GENERAL DIRECTIONS

A. Fitting and Identification of Pieces

Each piece or part of a piece is numbered. The sequence of these pieces will tell you the order in which the pieces should be cut out and assembled. The numbers of the pieces do not appear on the pieces themselves. Therefore, it is wise to write the correct number on each piece with a pencil before cutting the piece out, so that you can identify it when ready to assemble it. To make any individual piece, spaces on that piece bearing identical letters should be glued together. **Example:** On piece 18, the part marked "aa" should be glued, after folding, to the other part marked "aa" of piece 18.

Certain spaces on some pieces are labeled with a letter and a number. This means that the space with that letter on the piece with that number should be glued there. **Example:** On piece 3, the space marked "b4" should be covered by space "b" of piece 4, and glued together in that position. These rules should be followed without exception.

B. Cutting and Folding

With an X-acto knife (blade No. 11) and using a metal straight edge as a guide, cut all pieces on the solid lines. Broken lines (- - - -) indicate where you should fold away from yourself. In order to obtain an accurate fold, it is wise to score the line accurately and lightly with the dull side of your X-acto knife. Be careful not to cut through the paper. Lines indicated like this (+ + + + +) are those that you should fold toward yourself. These lines, as well, should be scored with the dull edge of your X-acto knife, but on the blank side of the sheet. To locate scoring lines on the blank side of the paper, make small pin holes on each end of the line.

